

# Multi-Function Portable Car Jump Starter User Manual

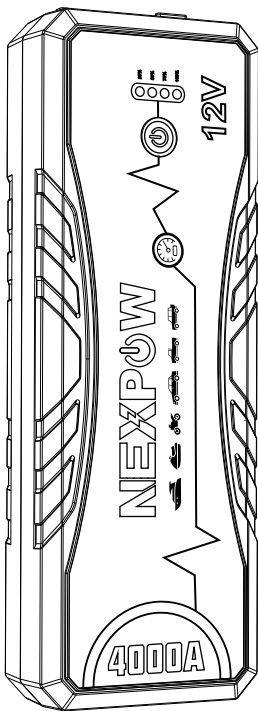

Model : Q11

EN





**Friendly Tips:**

Please carefully read the instruction manual and use product correctly based on the instruction manual so that you can be familiar with the product more conveniently and quickly!

Perhaps there is small difference between the photo and the actual product,so please turn to the actual product for detail information.

## What's in the Box

- NEXPOW Q11 jump starter x1
- Intelligent battery clamps with starter cable x1
- High quality USB-A to USB-C cable x1
- Car cigarette converter x1
- User-friendly manual x1
- Delicate carrying case x1

## Product Diagrams

1. USB 1: 5V/3A 9V/2A 12V/1.5A
2. USB2: 5V / 2.1 A
3. EC5 output / DUST cover
4. Type-C input: 5V/3A 9V/2A 12V/1.5A
5. DC output: 12V/10A
6. Power Button
7. LED Light

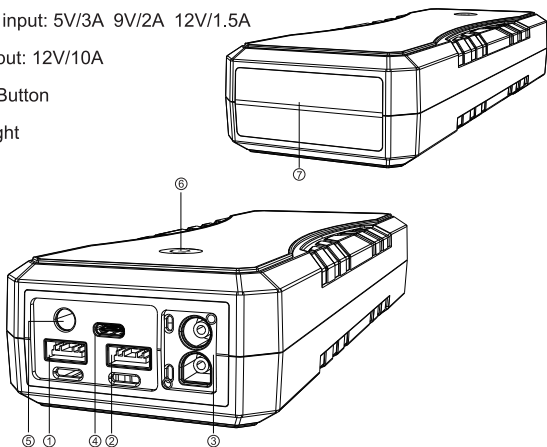



## Specifications

Cycle life	>1000 times
Capacity	88.8Wh
ECS output	12V/4000A (Max) Peak Cranking Power
USB1 output	5V/3A 9V/2A 12V/1.5A
USB2 output	5V/2.1A
Type-C in	5V/3A 9V/2A 12V/1.5A
DC output	12V/10A
Charging time	Type-C 5H
LED light power	White:1.5w
Working temperature	-10°C-60°C
Storage temperature	-10°C-60°C
Net weight	756g
Unltsize(LxWxH)	245X85X45mm

## Charge the Battery

Charging with an AC adapter (AC adapter is not included).

1. Connect the battery input with USB cable.
2. Connect the USB cable to AC adapter.
3. Plug the AC adapter into a power source.

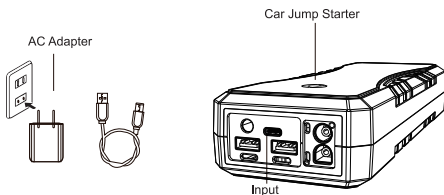

## How to Jump Start your Vehicle



This unit is designed for jump starting 12V car batteries. Do not attempt to jump start vehicles with a higher battery rating, or different voltage.

If the vehicle does not start immediately, Please wait for 1 minute to allow device to cool down. Do not try to restart the vehicle after three consecutive attempts as this may damage the unit. Check your vehicle for other possible reasons why it will not restart.

## Operating Instructions:

Please ensure the device is at least 50% charged before use

### Start the Car

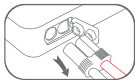
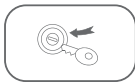
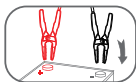
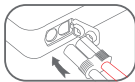

#### First step:

Insert plug of battery (terminal) into start outlet of start power.

#### Second step:

Connect the POSITIVE (RED) clamp from the jump starter to the POSITIVE post of the battery. Connect the NEGATIVE (BLACK) clamp to the NEGATIVE.

#### Third step:

Turn ON the car Engine to start Car.

#### Fourth step:

Pull out the plug of battery (terminal) from storage battery power supply and remove clips from auto battery.



## Abnormal Indication of Jumper Clamp

LETTER	STAND FOR	SOLUTION
LC	Low Capacity	Please charge jump starter
RC	Reverse Connection	Please exchange positive and negative poles of the jumper clamp
HT	High Temperature	Please wait 5 mins before starting the car



Forbid to use this clamp in an environment full of flammable gas.

## Jumper Clamp Indicator Instruction

STATUS	TECHNICAL PARAMETER	DESCRIPTION	SOLUTION
<p>Standby indication</p> 	<p>Blue light</p>	<p>Jump cables connect to jump starter, then <b>blue light</b> on</p>	<p>/</p>
<p>Automatic conduction status indicator (ready to jump start your car)</p> 	<p>Green light</p>	<p>Jump cables connect to the car battery after connecting the jump starter, then <b>green light</b> on</p>	<p>/</p>
<p><b>Force start function</b></p> 	<p>Start the car within 30s</p>	<p>If the above operations cannot start your car, please use the forced start function</p>	<p>Ensure the correct connection of clamps before using force start function, <b>long press the force start button</b> for 3 seconds until <b>green light</b> on</p>

PROTECTION	TECHNICAL PARAMETER	DESCRIPTION	SOLUTION
Reverse connection protection	RC	Wrong connection between jump cable and car's positive and negative poles. The <b>RC red light</b> stays on	Keep the correct connection, the positive pole (red) and the positive pole are connected, the negative pole (black) and the negative pole are connected
High temperature protection	YES	The <b>HT red light</b> stays on and beep long alarm sound; Cut off voltage output	Automatically recover when the temperature drops
Start timeout protection	40S±5S	Automatically enter the standby state after more than 40 seconds and The <b>LED blue light</b> stays on	You can use it again after disconnecting for a minute
Input low capacity protection	13.5V±0.5V	When it is detected that the power of the EC5 port is lower than 13.5V, there is no output at this time, the <b>LC red light</b> stays on and beep long alarm sound	Please charge jump starter
Short circuit protection	YES	No response	Please use the positive and negative poles of jump cables to connect the positive and negative poles of the car's engine to try to start your car

## How to Charge a Mobile Phone or Digital Products?



With high capacity and Two USB Output Ports (one is 5V/9V/12V USB Quick Charge) , it can full charge your smartphones and tablets on the go up to 75% faster than a standard charger. And you can charge two devices at the same time.

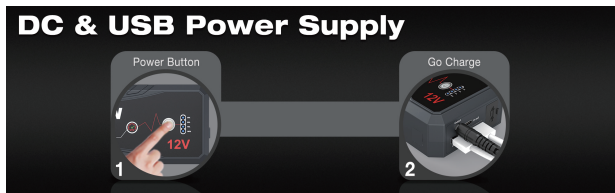

### First step:

Press the Power button.

### Second step:

Plug the USB port of the charging cable into the product USB interface, and Inset the other side into the input port of the a mobile phone or digital products.

# LED Flashlight



1. Press the Power button “”, then long press the button to turn the flashlight on. The BATTERY CAPACITY indicator will be lighted up. If no device is connected to the unit it will be turned off automatically.
2. Depress the Power button for 3 seconds to turn on the LED light and Depress again for 3 seconds to fully turn off the unit.

In the light mode, namely when LED flashlight is on, press Power button shortly again to cycle through Lighting, SOS, strobe light mode.

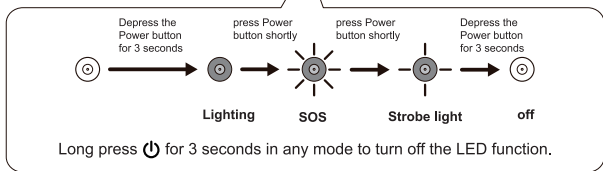
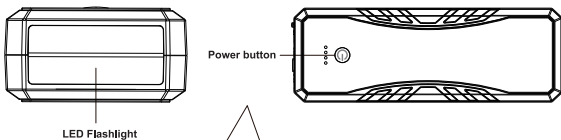

## FAQ:

Q: How to turn off the device?

A: This device is equipped with an intelligent detection system and will shut down automatically in 30 seconds once there is no load or it is fully charged.

Q: How long will it take before the device is fully charged?

A: It will take about 7 hours with the 5V/3A wall charger.

Q: How many times can Q11 charge the cell phone?

A: It depends on the capacity of your cell phone. Taking iPhone 6 as an example, Q11 can charge it about 10 times.

Q: How many times can this device jump-start a vehicle when it is fully charged.

A: It can jump-start the vehicle about 35 times.

Q: What is the lifetime of Q11?

A: About 3-5 years in general condition.

Q: How long can Q11 hold a charge?

A: With scientific circuit design, can Q11 hold charge up to 12 months. But in order to extend the service life of the lithium battery, we suggest charging it every three months.

Q: The wire clamp indicator shows red and there is a beeping alarm?

A: Red light constant with buzzing— Output has been cut due to (a) short circuit, (b) Over current, (c) Over temperature, (d) Overvoltage (e) Reverse connection.

Disconnect Smart Boost cable from unit and battery to reset.

If this still does not work, there may be a damaged cable clip, in which case you should contact our after-sales team to send a replacement cable clip.



# TROUBLE SHOOTING

## **Problem**

- 1.Nothing happens when pressing the power button.
- 2.No response to charging.
- 3.No USB cable/damaged cable clip.

## **Reason**

- 1.The voltage of Q11 is really low and triggers the low power protection to shut down the device.
- 2.Type-c data cable damage.
- 3.Missing packaging/damaged in transit.

## **Solution**

- 1.Plug the wall charger into the Q11 to recharge it.
- 2.Replace the type-c cable and keep it charged for 4-5 hours before observing.
- 3.Contact our technical team for replenishment.



## **Danger and Warning and Caution in Handing the Battery**

1. Never short circuit the jump starter by connecting the Red and Black clamps.
2. Do not disassemble the jump starter.
3. When children use this products, please operate under the guidance of parents.
4. Store in a dry place, do not expose to damp conditions or near corrosive materials.
5. If the jump starter expands, leakage or peculiar smell is found, stop use immediately.
6. Please use this jump starter at normal temperature and be far away from too wet, too hot and fire.
7. Do not starter the vehicle continously, between starting twice you should allow an interval of at least 30 seconds to 1 minute.
8. When the battery power is less than 10%, do not use the jump starter as it will damage the unit.
9. Before first use charge for 3 hours or more.

In case of disoperation, what shall happen in case of contact between positive and negative polarities of storage battery wire clip?

In case of reverse polarity connection by mistake, the produc comes with related protection measurements to avoid life-injury&property loss.



**NEXP<sup>⚡</sup>OW**

<b>时间：</b>	2022-12-12
<b>产品型号：</b>	Q11
<b>尺寸：</b>	95*140mm
<b>材质：</b>	128g铜版纸
<b>颜色：</b>	专色印刷
<b>工艺：</b>	骑马钉