

INON Z-330

User Manual

Operational limitation on flashing/Focus Light

Thank you for purchasing INON Z-330.

Please use your Z-330 within following operational limitations to avoid possible heat generation/degradation of light emitting part and inner electrical circuit etc.

Limitation of Focus Light continuous mode

The Focus Light should NOT continuously turn ON more than 30 minutes and make sure to cool down its LED unit and inner electrical circuit by turning OFF the Focus Light at least 5 minutes.

For maximum battery life, the Focus Light should be turned ON only when necessary to minimize heat generation and battery drain.

Limitation on repeated flashes

The table below explains maximum number of repeated flashes (*1). Make sure to cool down light emitting part and inner electrical circuit of the strobe by NOT making flash for at least about 5 minutes.

Also additional 5 minutes cooling-down period is required by turning OFF the Main Mode Switch after total number of flashes according to the table below.

Z-330 Switches Setting [Z-330 flash output]		Maximum number of repeated flashes	Total number of flashes
Main Mode Switch	EV. Control Switch		
FULL	--	10 flashes	50 flashes
M-0.5▼-6	-0.5、-1	10 flashes	50 flashes
	-1.5、-2、-2.5、-3	30 flashes	100 flashes
	-3.5、-4、-4.5、-5、-5.5、-6	50 flashes	150 flashes
S-TTL	-- [Marginal far end] (*2)	10 flashes	50 flashes
S-TTL "Low"	-- [approx. -1.5EV.~ -3EV.] (*3)	30 flashes	100 flashes
	-- [less than approx.-3.5EV.] (*4)	50 flashes	150 flashes

*1 Repeated flashes at or less than 30 seconds intervals.

*2 Actual flash output is marginal far end of exposure range (S-TTL,S-TTL "Low": approx. -1EV.)

*3 Actual flash output is approximately -1.5EV.~ -3EV.

*4 Actual flash output is less than approximately -3.5EV.

INON Z-330

User Manual

Thank you for purchasing INON Z-330

- Before using, please make sure to read this user manual, 「Safety Precautions」 and 「Safety Precautions on Batteries」.
- Always ensure proper operation of the Z-330 strobe according to this use manual
- Keep this user manual handy for quick reference.

Contents

Check Strobe and Accessories	1
Safety Precautions	2
Safety Precautions on Batteries	4
Before Using the Z-330 Strobe	5
Prevent Accidental Flooding	6
Nomenclature	9
Controls	10
Displays	12
Preparation	12
O-ring Maintenance	12
Load Batteries	12
Options to Connect to Camera	14
Connecting with Camera	15
Taking a Photo	20
Optical Connection (Optical D Cable, Wireless)	20
Electrical Connection (Sync Cord)	23
Using Strobe Light Shade	25
Using Strobe Dome Filter SOFT	26
Maintenance and Storage	27
Troubleshooting	29
After Service	31
Specifications	32

Check Strobe and Accessories

When unboxed, please check all contents below have been included. Should you find anything missing, please contact your purchasing dealer.



Z-330 Strobe
(with preinstalled items★)



★Strobe Light Shade



★Strobe Dome
Filter SOFT



★Sensor Cap



★Sync Connector Cap



INON Grease

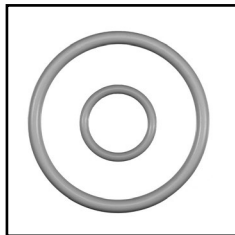

Spare O-ring (for Battery
Box, Sync Connector Cap)

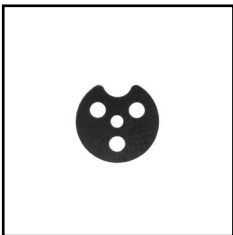

TTL Insulation Plate (2)

- Sensor Cap
- Caution Sticker
- Repeated Flash Limitation Sticker
- This user manual

Safety Precautions

- Before using, please make sure to read 「Safety Precautions」 and 「Safety Precautions on Batteries」 to ensure safety and proper operation of the product.
- Safety precautions described here are to prevent your and other people's injuries or damage.
- When using accessories, read through respective manual(s) as well.



DANGER

Failure to observe the precautions by this symbol may lead to high possibility of serious injury or death.

NEVER attempt to disassemble, modify the strobe

DO NOT touch exposed internal portions as a result of damage

The high-voltage circuitry in the strobe may lead to electric shock even without batteries. Those activities could cause malfunction/flooding.

STOP operating the strobe (including function check on land) if any water is observed inside strobe or strobe operates improperly.

The product could burn or explode leading to serious injury or malfunction/flooding may cause abnormal operation leading personal injury. Immediately turn OFF the strobe and execute controlled ascent to surface then wipe off the strobe completely and unload batteries not to get burned. Contact your purchasing dealer for repair.

Prevent water/foreign substances from entering strobe

Avoid replacing batteries in splashed or humid area

Malfunction causing abnormal operation or flooding could lead to personal injury.

DO NOT fire the strobe/turn on the Focus Light in front of person's eyes (particularly an infant).

The flash/light may cause irreparable injury to the eyes or cause temporary visual impairment to avoid safety relating operations.

DO NOT cover/touch light emitting part by hand during flashing or after rapid flashing

Light emitting parts becomes hot and may cause burn. Malfunction causing abnormal operation or flooding could lead to personal injury.

DO NOT use the product in area with flammable or explosive gas.

Using the product in such area could cause fire ignition, explosion or fire.

DO NOT use organic solvent like alcohol, benzene or thinners, or antirust, lubricant, polish or detergent (especially alkaline detergent) to clean the strobe.

Using those chemicals may cause damage on the product or fire ignition, explosion or fire.

Keep the strobe out of reach of children

Their inability to read and understand warnings may lead to serious injury. They may swallow parts of the strobe or batteries. See a doctor immediately if a child swallow parts or batteries.

DO NOT fire the strobe on land except functional check.

DO NOT fire the strobe shorter than 30 sec. interval during functional check on land.

DO NOT turn ON the Focus Light more than 5 min. during functional check on land.

Make sure to rest the product for 5 min. when the product has been fired 10 flashes at FULL or FULL -1.0 E.V. in 30 sec. underwater.

Excessive heat can damage inner circuitry.

DO NOT use the strobe in aircraft or proximity of medical equipment.

The strobe can interfere with flight instruments or medical equipment.

Turn OFF the product after use. (Never leave the product with power ON)

Unload flat batteries immediately

Flammable gas may be generated from batteries to cause explosion of the product. Loaded flat batteries may leak or generate heat to cause fire, personal injury or damage on premises.

Unload batteries when not in use or during transportation

Vibration etc. may cause unexpected operation leading to fire or personal injury. Loaded batteries may leak or generate heat to cause fire, personal injury or damage on premises.

DO NOT apply heat on the product

The product may be burned or exploded to cause serious personal injury. Malfunction causing abnormal operation or flooding could lead to personal injury.

**CAUTION**

Failure to observe the precautions by this symbol may result in possibility of injury or property damage

DO NOT apply strong vibration or shock to the product by dropping or hitting against something. Take special care not to apply strong shock to protruded Slave Sensor of the strobe.

Damage to the strobe may cause malfunction or flooding which may cause fire or personal injury.

DO NOT “jump” into water with the product or photographic equipment

Malfunction, abnormal operation, flooding or strobe setting change caused by shock when entering water may cause personal injury.

DO NOT leave/store the strobe subject to direct sunlight or high temperatures, such as beach, boat deck, dashboard or trunk of a car.

Abnormal operation caused by malfunction or deformation of outer body may lead to flooding to cause fire or personal injury.

Remove Battery Box Outer Cap when transporting in an aircraft or through a place with lower air pressure than ground level

This product is not designed to have lower pressure inside and may lose water-proof property leading to flooding to cause personal injury.

Safety Precautions on Batteries

**DANGER**

Failure to observe the precautions by this symbol may lead to high possibility of serious injury or death.

DO NOT use batteries other than batteries specified in this manual.

Usable batteries:

- Panasonic AA “eneloop” rechargeable battery (Model: BK-3MCC) **【Recommended】**
- Panasonic AA “eneloop pro” rechargeable battery (Model: BK-3HCD) **【Recommended】**
- AA NiMH Battery other than above (1.2V) [good quality]
- AA Alkaline Battery (1.5V)
- AA Lithium Battery (1.5V)

DO NOT throw a battery in a fire or heat it. Never attempt to disassemble or short-circuit a battery.

DO NOT immerse battery in water or wet it.

DO NOT use abnormal battery causing leakage, discoloration, deformation or outer damage

DO NOT mix old and new batteries, recharged and discharged batteries or batteries of different capacities, types, brand or manufacturer.

DO NOT attempt to recharge non-rechargeable batteries.

Always use specified charger by battery manufacture. Follow any other instructions indicated by battery/battery charger user manual.

DO NOT load batteries with the +/- battery terminal reversed.

Follow any other instructions indicated on battery/battery user manual.

Dispose batteries in accordance with all applicable federal, state and local regulations.

If a battery leaks . . .

- Immediately move away from fire to avoid possible risk of fire, explosion.
- If battery fluid contacts eye, immediately wash with a lot of clean fresh water without rubbing it and consult a doctor.
- If battery fluid gets into the mouth, immediately wash with a lot of fresh water and consult a doctor.
- If battery fluid contacts skin or cloth, immediately wash with a lot of fresh water.

Before Using the Z-330

Make sure to take test shots before using the Z-330 underwater to make sure it works properly especially before taking important shot(s).

INON Inc. cannot indemnify anyone for any loss/damage regardless of whether it is directly/indirectly caused by malfunction/flooding of the product.

Prevent Accidental Flooding

The Z-330 secures waterproof property due to a rubber O-ring.

O-rings, O-ring contact surfaces must be inspected/cleaned each time before using strobe to ensure waterproof integrity to prevent accidental flooding. After inspection/cleaning, apply grease on O-rings/O-ring contact surfaces.

■ O-ring Inspection Location

1 Battery Box O-ring

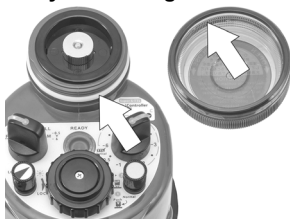

[Battery Box]

→ Check condition of Battery Box O-ring, O-ring groove

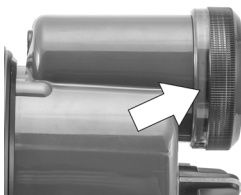

[Battery Box Outer Cap]

→ Check condition of O-ring contact surface and visually check if the O-ring is uniformly

2 Sync Connector Cap O-ring

[Sync Connector Cap]

→ Check condition of Sync Connector Cap O-ring and O-ring groove

[Sync Connector]

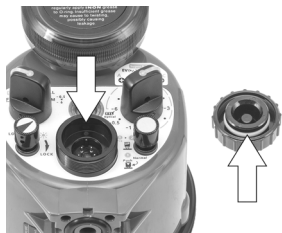

3 Sync Cord O-ring (Electrical Connection)

[Sync Cord]

→ Check condition of Sync Cord O-ring and O-ring groove

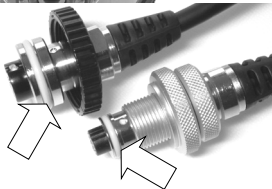

■ O-ring Inspection

These are the essential factors below ensuring waterproof property:

- O-ring itself
- O-ring contact surfaces
- O-ring grooves
- If an O-ring is properly seated in a groove
- Grease

1 Is O-ring twisted?

→ Remove the O-ring and re-install properly



2 If the O-ring, O-ring Contact surface or O-ring groove is cut, cracked, deformed or swelled.

→ O-ring: Replace with new O-ring

→ O-ring contact surface, O-ring groove: Not usable as it is.
Please consult with your purchasing dealer for repair.

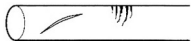

3 If hair, sand, lint or other debris is attached.

→ O-ring, O-ring groove:

Remove O-ring and wipe-off debris completely, apply grease and re-install the O-ring.

→ O-ring contact surface: Wipe-off debris completely



■ How To Apply INON Grease

 Use INON Grease Only

1 Sync Connector Cap O-ring, Sync Cord O-ring

Apply small amount of grease and apply on an O-ring uniformly with fingertip. Be careful not to apply grease on electrical terminals of the Sync Connector or Sync Cord.

2 Battery Box O-ring

The battery box O-ring may be cut or damaged by friction, so add a little extra grease to the O-ring and its O-ring contact surface. Also, slowly rotate the battery box outer cap whenever opening/closing Battery Box Outer Cap not to apply excessive load to the O-ring.

■ Installing/Removing O-ring

Be sure to follow below procedure whenever to install/remove an O-ring to avoid fatal flooding caused by poor O-ring handling.

- 1 To remove, lightly squeeze from the sides so it bulges out from one side, grasp and pull off slowly. Use U-shape part of a gem clip to slowly pull out the Sync Connector O-ring.

! Never use sharp material to remove an O-ring



- 2 Clean any residual grease from the O-ring and O-ring groove, and check the condition of both surfaces.



- 3 Using your fingertips, apply a thin uniform film of INON grease on the O-ring. Use the packaged spare O-ring if the original one shows any deformation/swell/crack/cut or other irregularity.

- 4 Gently install the O-ring in the O-ring groove, not stretching it too much, and making sure it is seated uniformly and not twisted.



Nomenclature

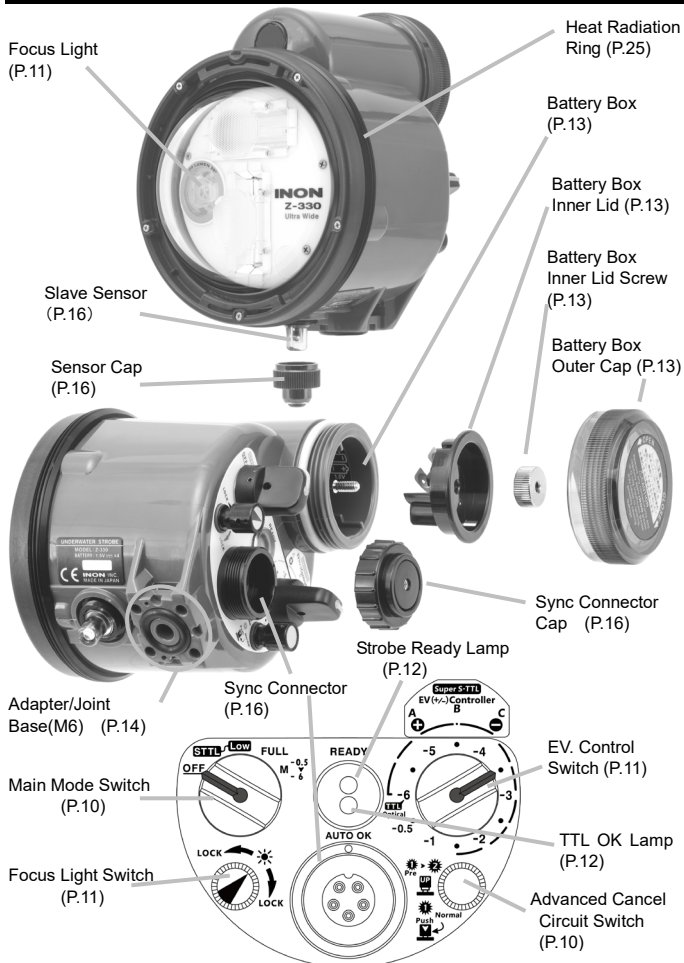

Controls

Main Mode Switch

OFF Turn OFF the strobe

STTL Automatic flash control
Not usable for a digital camera *not* making pre-flash or connected via sync cord.

Low Use this mode if S-TTL delivers overexposure

Some compact camera carrying poor exposure controllability with its built-in flash can use this mode to avoid overexposed images. Refer to 「Troubleshooting」(P.29).

FULL Strobe always makes full dump.

M -0.5▼-6 Manual flash mode other than FULL amount.

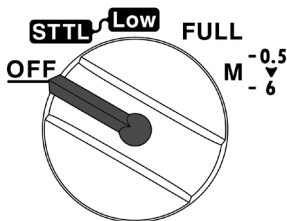

Advanced Cancel Circuit Switch

Push and turn to right/left to lock the switch either in below cases.

Optical Connection When connected to a digital camera *not* making pre-flash or film camera.

Sync cable Connection When connected to a digital camera or film camera (TTLAuto).

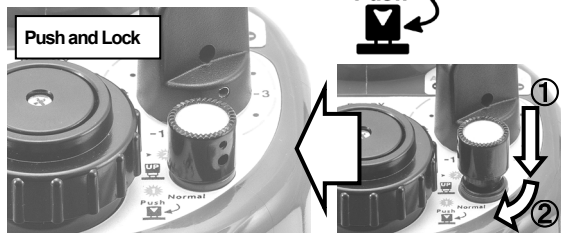
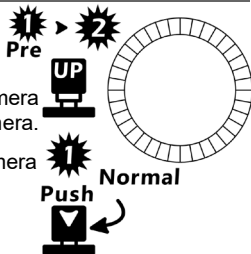

EV. Control Switch

Main Mode Switch: **M** -0.5▼-6

12 power settings available
(-0.5EV. ~-6EV. with 0.5EV. increments)

Main Mode Switch: **STTL**

10 steps fine adjustment is available when connected with a pre-flash type camera via fiber optics (within a range of orange arc from 9 o'clock through 6 o'clock position)

Set to **[-6]** when connected with a film camera via fiber optics.

(Fine adjustment is not available)

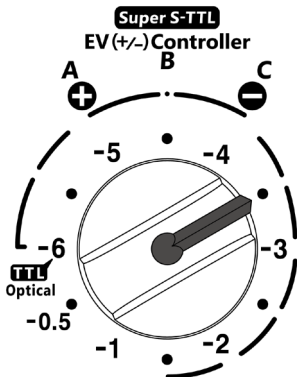

Focus Light Switch

One push will turn ON the Focus Light about 6 seconds.

When push and lock the switch to the right/left will turn ON the Focus Light continuously.

The Focus Light turns OFF in synch with strobe firing and back on after about 0.5 seconds or when the Ready Lamp turns on.

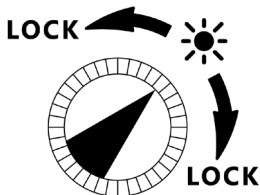

DON'T keep turning ON the light more than 30 mins. and cool it down more than 5 mins.





Low battery may cause flickering or low output of the Focus Light. Change batteries if this happens.

Displays

Strobe Ready Lamp

Shines red when strobe becomes ready to flash.

 Insufficient battery capacity for proper functioning may cause 10 sec. (Alkaline battery)/5 sec. ("eneloop" battery) or more before you see red light after power on the strobe. It would be advisable to change batteries before this happens.

 The Strobe Ready Lamp will be activated when the strobe has been charged about 80%. So please wait for another couple of seconds when firing the strobe nearly full power either in Manual or S-TTL Auto mode.

AUTO OK Lamp

Shines green for about 2 seconds after firing when auto exposure mode works. Firing full power doesn't shine this lamp.

 Indication may not be accurate when the strobe fires nearly full power.

Preparation

O-ring Maintenance

Conduct O-ring maintenance according to 「Prevent Accidental Flooding」(P6). Especially make sure to conduct maintenance of the Battery Box O-ring before loading batteries.

Load Batteries

 **DO NOT** load batteries in the area to get splashed or with high humidity. The strobe must be dry. If this is not possible, make sure to thoroughly wash Z-330 in fresh water and completely wipe dry, then facing down the battery box cap to open so no water enters inside of the battery box.

This product requires four AA batteries of same type / model / capacity / charge status among below 5 categories

- AA “eneloop” battery (BK-3MCC) [recommended]
- AA “eneloop pro” battery (BK-3HCD) [recommended]
- AA Ni-MH battery (good quality)
- AA Alkaline battery • AA Lithium battery (1.5V)

1 Set Main Mode Switch to [OFF] and EV. Control Switch between [-3] and [-4] (2 o'clock position) as in the right figure.

2 Remove the Battery Box Outer Cap and Battery Box Inner Lid Screw by slowly rotating counterclockwise.

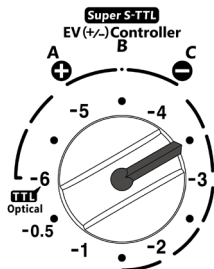

! Be careful not to catch your finger between the Battery Box Outer Cap and EV Control Switch.

! Make sure to rotate the Battery Box Outer Cap slowly not to damage the Battery Box O-ring.

3 Remove Battery Box Inner Lid and load batteries with proper orientation indicated inside of the battery box.



- 4** Align notches of the Battery Box Inner Lid with ridges inside of the Battery Box to place the Battery Box Inner Lid in position.
- 5** First attach the Battery Box Inner Lid Screw then Battery Box Outer Cap by rotating them clockwise.

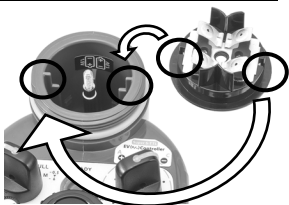

 Stop tightening screw/cap when they are lightly stopped. (**DO NOT** tighten to much)

 Make sure to rotate the Battery Box Outer Cap slowly not to damage the Battery Box O-ring.

- 6** Visually check Battery Box O-ring to see if the O-ring is not came off (slipped off from O-ring groove) and is compressed uniformly with 1.5mm or wider flat area around the complete circumference.



Options to Connect to Camera

Select either options below according to your housing or shooting condition and attach it on the strobe at Adapter/Joint Base (M6).

Z Adapter MV

Z Joint

Direct Base III

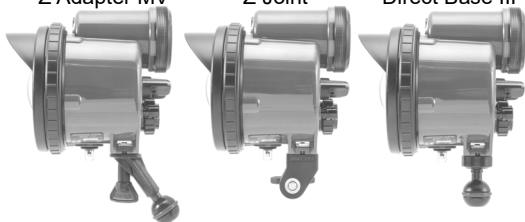

For detail,
please refer to
user manuals of
respective
optional parts or
our web site

Connecting with Camera

Depending on camera/housing, necessary cable, compatible flash mode/strobe setting differs.

Below tables explain connection method for optical connection [Optical D Cable/Wireless Connection] and electrical connection [sync cord].

Please refer to 「Taking a Photo」 (P20) for detailed setting when shooting.

Optical Connection (Optical D Cable, Wireless) Compatibility

Camera		Digital Camera		Film Camera
		Built-in Flash * with Pre-flash	Built-in Flash Without Pre-flash	INON X1 Housing
Flash mode/Strobe setting				
Manual (FULL)	Main Mode Switch	FULL		
	Advanced Cancel Circuit Switch	Up	Push and Lock	
	EV. Control Switch	-----		
Manual (-0.5~-6)	Main Mode Switch	M -0.5▼-6		
	Advanced Cancel Circuit Switch	Up	Push and Lock	
	EV. Control Switch	12 steps		
Auto Exposure (Digital: S-TTL Film: TTL)	Main Mode Switch	STTL (*)	/	STTL
	Advanced Cancel Circuit Switch	-----		-----
	EV. Control Switch	10 steps (within orange arc)		「-6」 (**)

* Some compact cameras may have better results with [Low] instead of [STTL] in case [STTL] delivers overexposed images. Please refer 「Trouble Shooting」(P30) for detail.

** Not able to make fine power adjustment.

Electrical Connection (Sync Cord) Compatibility

Camera		Digital Camera	Film Camera
		INON X-2 Housing	INON X1 Housing * Nikon Nikonos RS/V
Flash mode/Strobe setting			
Manual (FULL)	Main Mode Switch	FULL	
	Advanced Cancel Circuit Switch	Push and Lock	Up (***)
	EV. Control Switch	-----	
Manual (-0.5~-6)	Main Mode Switch	M -0.5▼-6	
	Advanced Cancel Circuit Switch	Push and Lock	Up (***)
	EV. Control Switch	12 steps	
Auto Exposure (TTL)	Main Mode Switch	/	STTL
	Advanced Cancel Circuit Switch		Push and Lock
	EV. Control Switch		-----

*** Nikonos V「M90」 mode needs [Push and Lock].

Optical Cable Connection

Connect with an Optical D Cable (option) to trigger this product by digital camera's built-in flash. Also this product can be connected to a film camera housing (INON X1) which supports optical connection via Optical D Cable.

Variety of optional parts to fix an optical cable on different housing are available. Please contact your purchasing dealer or refer to our web site for detail of compatibility.

1 Set Main Mode Switch to [OFF] and EV. Control Switch between [-3] and [-4](2 o'clock position).

2 Make sure that sync connector cap is attached.
(The cap is pre-installed when shipping from INON)

If the cap is removed, attach it following below procedure.

- a) Conduct maintenance of Sync Connector Cap O-ring.
- b) Put the Sync Connector Cap over the sync connector and press its center part.
- c) With pressing the center part, tighten the outer rim clockwise until it stops.

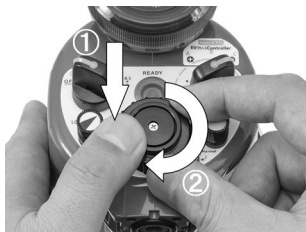

3 Remove the Sensor Cap.

4 Attach Sensor Plug of the Optical D Cable on the Slave Sensor.



Screw the Sensor Plug straight in and stop tightening when it lightly stops.
(DO NOT overtighten)



- 5** Attach the Optical D Cable on the housing
Refer to respective user manuals of the housing/optional product.

Wireless Connection

Some digital camera can trigger the strobe without cable by optional Wireless Connection Kit.

Please refer user manual of the Wireless Connection Kit or INON web site, or contact your purchasing dealer.

Sync Cord Connection

A film camera/housing equipped with a sync connector can use optional sync cord to connect between camera/housing and this product. (Nikon Nikonos RS/V, INON X1 housing).

A housing for digital camera with a sync connector can also use a sync cord (INON X-2 housing).

For detail, please refer to user manual of camera/housing or INON web site, or contact your purchasing dealer.

 A dual sync cord is NOT usable as it may damage this product.

- 1** Set the Main Mode Switch to [OFF] and EV. Control Switch between [-3] and [-4] (2 o'clock position).

- 2** Attach the Sensor Cap on the Slave Sensor
(The cap is preinstalled when shipping)

 Make sure to attach the Sensor Cap or the strobe may show abnormal operation.



- 3 Conduct maintenance of sync cord O-rings according to 「Prevent Accidental Flooding」(P6) and user manual of the sync cord.
- 4 Unscrew the sync connector cap counterclockwise and pull it out once completely unscrewed.



- 5 Plug the sync cord straight all the way in the sync connector on the strobe so that the notch of the sync cord and protrusion of the sync connector is matched.

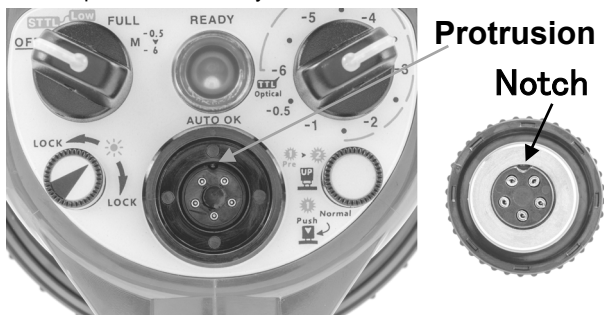

- 6 While pressing the sync cord in, tighten the outer rim to fasten the cord.

 Push the cord end straight in all the way down to the sync connector

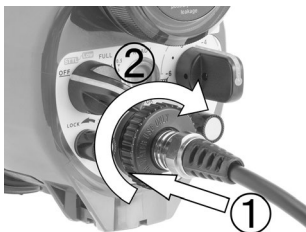

7 Remove sync connector cap of the camera/housing.
Refer to user manual of the camera/housing for detail.

8 Put the sync cord end straight in the camera/housing side sync connector all the way so that the notch of the sync cord and protrusion of the sync connector on the camera/housing side is matched.

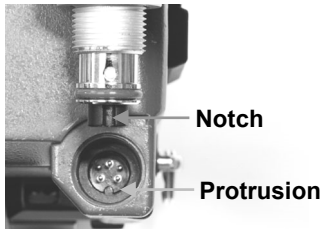

9 While pushing the sync cord, tighten the upper ring clockwise.

10 Tighten lower ring clockwise until it stops.

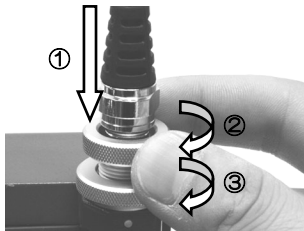

! Make sure to tighten the upper ring first then lower ring. Refer to the user manual of the sync cord before this procedure.

Taking a Photo



When making sequential firing (series of flashes within 30 seconds interval), stop firing at accumulative numbers of flashes below to cool down the strobe 5 minutes or more

FULL	~ -1 EV.	: 10 times
-1.5 EV.	~ -3 EV.	: 30 times
-3.5 EV.	~ -6 EV.	: 50 times

In addition to above, turn OFF the strobe for 5 minutes or more when total flash numbers reach to below regardless of sequential or not sequential firing.

FULL	~ -1 EV.	: 50 times
-1.5 EV.	~ -3 EV.	: 100 times
-3.5 EV.	~ -6 EV.	: 150 times

Optical Connection (Optical D Cable, Wireless)

Turn off camera's red-eye reduction mode.

Select 「force flash」 「fill-in flash」 on digital camera's built-in flash and turn off modeling light or AF assisting light by the built-in flash.

Refer to INON web site to see compatible digital cameras.

Manual Flash

Control flash output manually.

1 Set the Advanced Cancel Circuit Switch as below based on combined camera.

- Pre-flash digital camera : **[Up]**
- No pre-flash digital camera : **[Push and Lock]**
- Film camera(INON X1) : **[Push and Lock]**

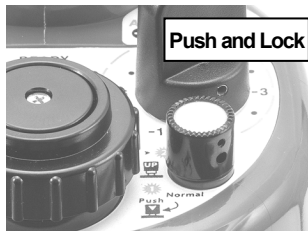
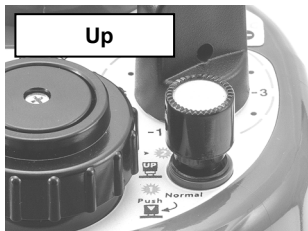

2 Set the Main Mode Switch to **[FULL]** or **[M -0.5▼-6]**.

3 When Main Mode Switch is **[M -0.5▼-6]**
Adjust flash output with the EV. Control Switch.

- Dialing counter clockwise up to **[-6]** decreases flash output.
- Dialing clockwise up to **[-0.5]** increases flash output.
(12 steps with 0.5EV. increments)

4 Take a photo.

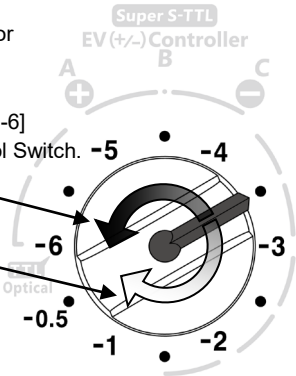

S-TTL Auto

Pre-flash type digital camera can use the S-TTL Auto mode supported by fine output adjustment.

1 Set the Main Mode Switch to **[STTL]**

2 Set the EV. Control Switch to **[B]** position
(12 o'clock position, between **[-4]** and **[-5]**)

3 Take a photo.

4 If necessary adjust the output with
the EV. Control Switch.

- Dialing counterclockwise increases the power.
- Dialing clockwise decreases the power.
(Total 10 steps within orange arc)

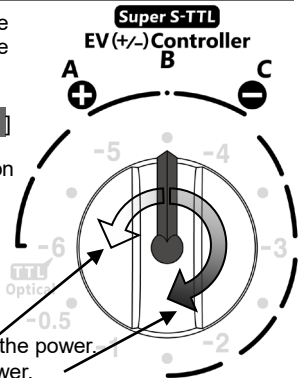

Effectiveness of the EV. Control Switch varies depending on combined camera or shooting condition. If it should not work as you wish, then use camera's exposure compensation or take procedure in the next page.

■ When images are overexposed

Try to change camera setting as one of below or in combination if power adjustment setting with minimum output still have overexposed or washed out images.

- 1 Use bigger f-number (close the aperture).
- 2 Locates strobe bit further from a subject.
- 3 Use lower ISO speed.

■ When images are underexposed

Try to change camera setting as one of below or in combination if power adjustment setting with maximum output still have underexposed or black out images.

- 1 Use smaller f-number (open the aperture).
- 2 Locates strobe close to a subject.
- 3 Use higher ISO speed.

■ When images show blue cast

Try to change camera setting as one of below or in combination if you see bluish image overall without natural color.

- 1 Use faster shutter speed.
- 2 Use lower ISO speed.

TTL Auto

Optical connection compatible film camera housing (INON X1) can use TTL Auto mode.

*No fine adjustment is supported in this mode.

- 1 Set the Main Mode Switch to [**STTL**]
- 2 Set the EV. Control Switch to [**TTL Optical**] ([**-6**], 9 o'clock position).
- 3 Take a photo.

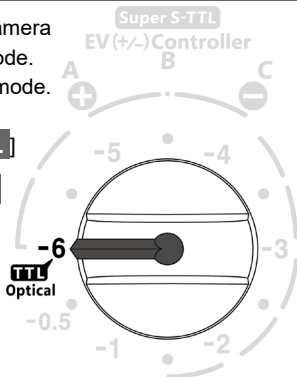

Electrical Connection(sync cord)

Manual Flash

Control flash output manually.

1 Set the Advanced Cancel Circuit Switch as below based on combined camera.

- Digital camera (INON X-2) : **[Push and Lock]**
- Digital camera (other than INON X-2): **[Push and Lock]** (⚠)
- Film camera (INON X1, Nikonos RS/V) : **[Up]**
- Film camera (Nikonos V M90 mode) : **[Push and Lock]**

⚠ Some housing other than INON X-2 may not be able to control flash output manually due to housing specification. Use bundled TTL Insulation Plate in such case (Refer to the next page for detail).

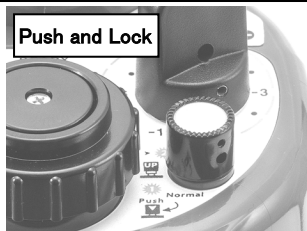
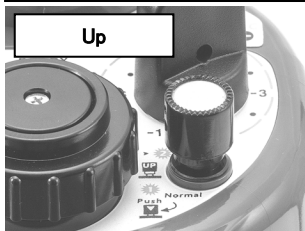

2 Set the Main Mode Switch to **[FULL]** or **[M -0.5▼-6]**.

3 When Main Mode Switch is **[M -0.5▼-6]**
Adjust flash output with the EV. Control Switch.

- Dialing counter clockwise up to [-6] decreases flash output.
- Dialing clockwise up to [-0.5] increases flash output.
(12 steps with 0.5EV. increments)

4 Take a photo.

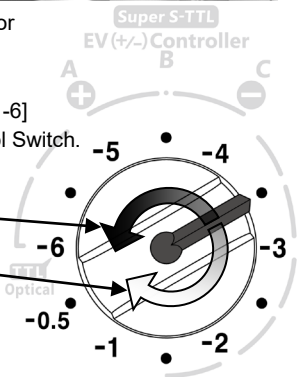

■ Installing TTL Insulation Plate

- 1 Slowly drop the TTL Insulation Plate in the sync connector on camera/housing so that its notch and protrusion in the sync connector is matched and confirm that the TTL Insulation Plate seats at the bottom of the sync connector as in below right image.

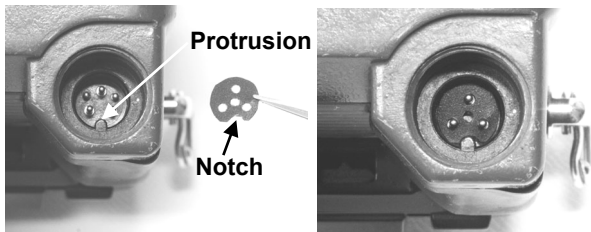

- 2 Plug a sync cord in the sync connector on the camera/housing not to displace the TTL Insulation Plate.

TTL Auto

An electrical connection compatible film camera housing (INON X1) and camera (Nikonos) can use TTL Auto mode.

*No fine adjustment is supported in this mode.

- 1 [Push and lock] the Advanced Cancel Circuit Switch.
- 2 Set the Main Mode Switch to **[STTL]**.
- 3 Take a photo.

Using Strobe Light Shade

The Strobe Light Shade cut a part of strobe light (Preinstalled when shipping). The shade is rotatable to cut strobe light for any direction. The Strobe Light Shade is easily removable but please leave it on for general use.



When removing the Strobe Light Shade, o use the strobe without the Strobe Light Shad be careful not to damage fingers by sharp threads of the Heat Radiation Ring.

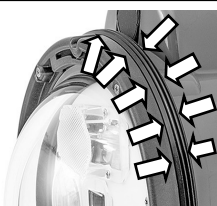

■ Installation

- 1 Align the groove on the front upper end of the strobe and the guide mark of the Strobe Light Shade then put the Strobe Light Shade straightly on the front end of the strobe.
- 2 Rotate the threaded ring of the Strobe Light Shade clockwise to fasten it on the strobe.



Screw the threaded ring straight in until it lightly stops.
(DO NOT overtighten)

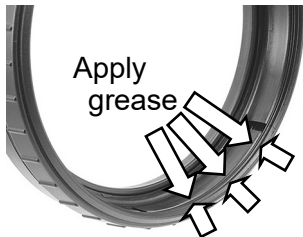

If you feel too tight to screw, remove the Strobe Light Shade and apply small amount of grease on the inner threaded part. **DO NOT** tighten any further with feeling hardness as the Strobe Light Shade could be jammed on the strobe.

Using Strobe Dome Filter SOFT

Diffuses and softens strobe light (Preinstalled when shipping).

This filter does not widen strobe beam angle and cut strobe output at 「approx.0.3EV.」 underwater. Attach this filter when you prefer 「soft flash light」 or want to 「protect front dome of the strobe」. Otherwise use the strobe without this filter.

■ Installation

- Put the Strobe Dome Filter SOFT on the strobe front dome so that protruded flanges located on 12/6 o'clock positions around strobe front dome seat in cutouts of the Strobe Dome Filter SOFT as in the right image.

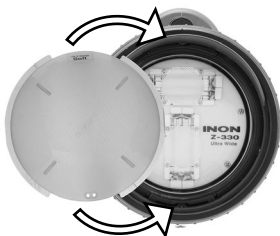

- Rotate the Strobe Dome Filter SOFT clockwise until you feel click where you should hear click sound.



The Strobe Dome Filter SOFT has holes for lanyard to strap to strobe arm etc.

*A lanyard is not bundled.



After Use Maintenance, Storage

Salt removal/Clean, Dry

- 1 Soak the strobe in freshwater within operable temperature ($0^{\circ}\text{C}\sim 30^{\circ}\text{C}/32^{\circ}\text{F}\sim 86^{\circ}\text{F}$) as it is for several hours to remove salt build-up.
- 2 Slowly move switches, levers and Strobe Light Shade to remove trapped sands and salt during above procedure.

 **DO NOT** unscrew/retighten the Battery Box Outer Cap, Sync Connector Cap or Sync Cord.

- 3 Blow off remaining water droplets by compressed air etc. and dry well the strobe in shaded, well-ventilated area within storage temperature range [$0^{\circ}\text{C}\sim 30^{\circ}\text{C}/32^{\circ}\text{F}\sim 86^{\circ}\text{F}$]

 Never apply flame or direct heat or damage may result

- 4 After surface is thoroughly dry, remove Battery Box Outer Cap and Inner Lid to remove batteries from Battery Box and continue to dry with Battery Box open. It may take several days for moisture in the small gaps and recesses of the strobe to completely dry.

O-ring Maintenance

After completely dry, inspect/grease O-ring in accordance with 「Prevent Accidental Flooding (P.6)」

Battery Terminals/Battery Box Contacts Maintenance

- 1 Gently bend the terminals back to the correct position, if they have been bent.

Correct



Bent



- 2** Clean battery terminals, Battery Box Inner Lid contacts and Battery Box contacts.

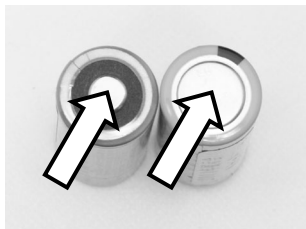
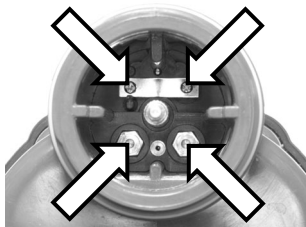
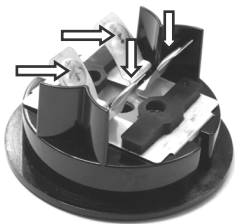

■ Cleaning Procedure

 When cleaning battery terminals, always check and follow precautions/restrictions of the battery.

 Make sure not to put chemical other than terminals.

- 1** Wipe terminal surface with a cotton swab (or similar) soaked in alcohol to remove any oil or similar residue.
- 2** (Only If the strobe shows unstable operation like suddenly stop charging and above step does not solve the problem) dap a small amount of silver polish on a cotton swab (or similar) and wipe terminal surface to remove oxidized film. Then clean off any silver polish residue with a clean swab.

Overhaul

To keep optimum performance of this product, it is necessary to receive periodic overhaul at INON or authorized service facility.

O-rings and other degradable parts life can vary considerably due to type of use, frequency of use, storage conditions etc., INON recommends overhaul once per year to prevent accidental flooding.

Storage

 Always remove batteries during storage

Close the Battery Box Outer Cap and store out of direct sunlight in well-ventilated, dry area within storage temperature [0°C~30°C/32°F~ 86°F].

Avoid storing near chemicals (camphor or naphthalene etc.), magnetic fields (TV etc.) and large temperature fluctuations (even within storage temperature).

It would be recommended to put a desiccant agent in the battery box during storage.

When not using the strobe for extended period, put in a set of batteries, test fire once, turn the Main Mode Switch to OFF when the red ready lamp comes on and remove batteries to prevent degradation of internal circuitry about once a month or so during the storage period.

Trouble Shooting

When you doubt malfunction of the product, please check below first then consult your purchasing dealer if problem remains.

Power

If Strobe Ready Lamp does not come on.

- Load compatible batteries? (P12)
- Load batteries with proper orientation? (P13)

If charging takes longer.

- Batteries have been sufficiently charged? (P12)
- Batteries degradation? (P12)
- Dirt on battery terminals, battery box contacts? (P27)

Basic Operation

If strobe doesn't fire...

- An Optical D Cable/Sync Cord is properly connected? (P16)
- An Optical D Cable has damaged or got dirt on its bear end?
A Sync Cord has got damaged or degradation of terminals?
- Camera's built-in flash fires? (When optically triggered. P20)

If the Focus Light flickers...

- Batteries have been sufficiently charged? (P11-12)

Exposure Control

If Manual flash mode gives underexposed images....

- Camera's built-in flash makes pre-flash or not... (Optical Connection only)
- Advanced Cancel Circuit Switch is properly set? (P15)
- Electrically connected with other brand housing? (P23)
- Camera's battery has degraded? (Nikonos V)
- Check compatible digital cameras on INON web site.

If Manual flash mode gives overexposed images (the strobe always delivers FULL)....

- Advanced Cancel Circuit Switch is properly set? (P15)
- Check compatible digital cameras on INON web site.

S-TTL Auto gives underexposed images....

- Does camera's built-in flash make pre-flash?
- Check compatible digital cameras on INON web site.

S-TTL Auto always gives FULL dump....

- An Optical D Cable is properly set? (P16-17)
- An Optical D Cable has damaged or got dirt on its bear end?
- Wireless Connection Kit is properly set? (When using wireless)
- Try [**Low**] instead of [**STTL**].
- Check compatible digital cameras on INON web site.

TTL Auto (electrical connection) does not give FULL power...

- Advanced Cancel Circuit Switch is properly set? (P15)

TTL Auto (electrical connection)

- Advanced Cancel Circuit Switch is properly set? (P15)
- A Sync Cord has got damaged or degradation of terminals?
- The Sensor Cap is attached?

After Service

Please contact your purchasing dealer for any questions about this product.

Please contact your purchasing dealer for product inspection/repair.

Z-330 sold by authorized overseas distributor/dealer carries Limited Warranty provided by the distributor/dealer. Warranty repair will be provided according to the warranty terms and conditions. In principle, repair service is not free of charge after the warranty period has expired. A customer is required to bear shipping costs to and from INON's designated repair facility. Please contact your authorized INON distributor/dealer for warranty service or warranty condition.

Manufacturer

INON INC.

2-18-9, Dai, Kamakura

Kanagawa 247-0061 JAPAN

E-mail support@inon.co.jp

Fax. +81 (0)467-48-2178

URL <http://www.inon.jp/>

Update history

- | | |
|--------------------|-----------|
| •December 22, 2017 | Ver.0.9.3 |
| •December 25, 2017 | Ver.0.9.4 |
| •February 20, 2018 | Ver.0.9.5 |

Specifications

Model	Z-330
Flash Mode (*1)	S-TTL Auto/TTL Auto/Manual
Connection (*1)	Optical Connection (Optical D Cable, Wireless) Electrical Connection (Sync Cord)
Settable Flash Output G.N. (*2)	FULL [1/1 (33)], -0.5 [1/1.4 (27)], -1 [1/2 (23)], -1.5 [1/2.8 (19)], -2 [1/4 (16)], -2.5 [1/5.6 (13)], -3 [1/8 (11)], -3.5 [1/11 (9.8)], -4 [1/16 (8.2)], -4.5 [1/22 (6.9)], -5 [1/32 (5.8)], -5.5 [1/45 (4.9)], -6 [1/64 (4.1)] (13 steps with 1/2EV. increments)
Beam Angle (*3)	110°×110° circular beam [flash light] 30° [Focus Light]
Focus Light Intensity	220lm (*4)
Color Temperature	Approx. 5500K [flash light/without Strobe Dome Filter SOFT] Approx. 5400K [flash light/with Strobe Dome Filter SOFT] 5300~6000K [Focus Light (*4)]
Recycle Time (*5)(*7)	Approx. 1.8 seconds minimum ["eneloop" batteries] Approx. 1.6 seconds minimum ["eneloop pro" batteries] Approx. 2.4 seconds minimum [Alkaline batteries] Approx. 3.5 seconds minimum [Lithium 1.5V batteries]
Flash Capacity (*5)(*7)	Approx. 210 flashes ["eneloop" batteries] Approx. 280 flashes ["eneloop pro" batteries] Approx. 200 flashes [Alkaline batteries] Approx. 330 flashes [Lithium 1.5V batteries]
Focus Light Operable Duration (*6)(*7)	Approx. 2 hrs 30 mins ["eneloop" batteries] Approx. 3 hrs 20 mins ["eneloop pro" batteries] Approx. 3 hrs 00 mins [Alkaline batteries] Approx. 4 hrs 00 mins [Lithium 1.5V batteries]
Compatible Battery	AA "eneloop" battery x 4 (Model: BK-3MCC) 【Recommended】 AA "eneloop pro" battery x 4 (Model: BK-3HCD) 【Recommended】 AA Ni-MH battery (*8) x 4 AA Alkaline battery x 4 AA Lithium battery (1.5V) x 4
Dimensions	Diameter: 102mm/4.0in., Height: 131mm/5.2in., Depth: 125mm/4.9in. [without Strobe Light Shade/Strobe Dome Filter SOFT] Diameter: 111mm/4.4in., Height: 131mm/5.2in., Depth: 129mm/5.1in. [with Strobe Light Shade]
Weight (air)	637g/22.5oz [without Strobe Light Shade, Strobe Dome Filter SOFT, batteries] 789g/27.8oz [with Strobe Light Shade, 4 x batteries]
U/W Weight (*9)	Approx. 48g/1.7oz [with Strobe Light Shade, 4 x batteries]
Working Temp.	0°C~30°C/32°F~86°F *water temperature
Storage Temp.	0°C~30°C/32°F~86°F *air temperature 50°C/122°F (temporary allowable temperature limit when strobe is not in use)
Depth Rating	100m/328ft
Body Material	Body: Polycarbonate/grey

Specifications (continued)

Package Contents	Strobe Light Shade, Strobe Dome Filter SOFT, Sensor Cap, Sync Connector Cap, Sensor Cap Caution Sticker, Repeated Flash Limitation Sticker, INON grease, Spare O-ring (Battery Box, Sync Connector), TTL Insulation Plate x2
EMC Standards	EN 55015:2013, EN 61547:2009, CRF 47 FCC Part 15 Subpart A and B, ICES-003:2016(Issue 6, Amendment 1)

- *1 Compatible flash mode/connection method varies depending on combined camera system and usable flash mode differs depending on connection method. Refer to this user manual for detail.
- *2 Measurement in air/ISO100 at 1 m without 「Strobe Dome Filter SOFT」, nominal value.
- *3 Underwater, nominal value.
- *4 Calculated from a spec. chart of LED manufacture, nominal value.
- *5 Measured with FULL strobe output at 30-second intervals with both Focus Light and Advanced Cancel Circuit OFF, at 25°C/77°F with test batteries giving 5 minutes cooling period every 50 flashes.
- *6 Operable duration is accumulated time of continuous mode with 5 minutes cooling period every 30 minutes at 25°C/77°F with test batteries.
- *7 Recycle Time/Flash Capacity/Focus Light operable duration based on INON test data. Actual values may vary using different battery manufacturer, battery type etc.
- *8 Not all Ni-MH batteries are confirmed compatible as some “conventional” or “high-capacity” NiMH rechargeable batteries have significant self-discharge and heat-generating characteristic causing difficulty to keep their performance during usage. Only when “eneloop” or “eneloop pro” batteries are not available, use good quality of Ni-MH rechargeable battery having less problem described above.
- *9 Measured in fresh water(25°C/77°F), nominal value.

Test battery:

“eneloop” battery	: Panasonic“eneloop”, BK-3MCC, 1.2V, Min.1,900mAh
“eneloop pro” battery	: Panasonic“eneloop pro”, BK-3HCD, 1.2V, Min.2,500mAh
Alkaline battery	: Panasonic“EVOLTA NEO”, LR6(NJ), 1.5V
Lithium battery (1.5V)	: FUJIFILM/Energizer LITHIUM, FR6, 1.5V

Specifications, performance subject to change without prior notice.

As of February 2018

FCC Notice

This device complies with part 15 of the FCC Rules. Operation is subject to the following two conditions:

- (1) This device may not cause harmful interference, and
- (2) This device must accept any interference received, including interference that may cause undesired operation.

Information to user

The user that changes or modifications not expressly approved by the party responsible for compliance could void the user's authority to operate the equipment.

NOTE: This equipment has been tested and found to comply with the limits for a Class B digital device, pursuant to part 15 of the FCC Rules. These limits are designed to provide reasonable protection against harmful interference in a residential installation. This equipment generates, uses and can radiate radio frequency energy and, if not installed and used in accordance with the instructions, may cause harmful interference to radio communications. However, there is no guarantee that interference will not occur in a particular installation. If this equipment does cause harmful interference to radio or television reception, which can be determined by turning the equipment off and on, the user is encouraged to try to correct the interference by one or more of the following measures:

- Reorient or relocate the receiving antenna.
- Increase the separation between the equipment and receiver.
- Connect the equipment into an outlet on a circuit different from that to which the receiver is connected.
- Consult the dealer or an experienced radio/TV technician for help.

ICES-003 Notice

This Class B digital apparatus complies with Canadian ICES-003.

Avis NMB-003

Cet appareil numérique de la classe B est conforme à la norme NMB-003 du Canada.

This manual is intended to be exclusively used for following unit.

Product	:	Z-330
Serial number	:	

The serial number above should correspond with serial number of the strobe comes with this manual. INON Inc. /INON overseas authorized distributor/dealer may not be able to offer official support/maintenance if;

1. Manual without serial number
2. Manual with unidentifiable serial number
3. Manual/part of Manual illegally copied against copyright term in the manual

INON

Reflective Sticker D/Z

Thank you for purchasing INON product.

The *Reflective Sticker D/Z* is a sticker with mirror surface designed to control Z-330/D-200 strobe beam range by sticking it on a *Strobe Light Shade* which is bundled with the Z-330/D-200 strobe

- Package contents**
- Reflective Sticker D/Z ① ×1
 - This user manual ×1

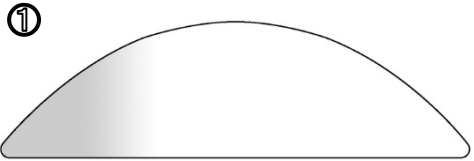

Compatible : ▪ Z-330, D-200
Strobe
 (as of January, 2020)

- Installation** :
- Put the *Reflective Sticker D/Z* on the inner side of a *Strobe Light Shade* so that it covers inner surface of the *Strobe Light Shade* before removing its base sheet as per image (A) below.
 - Peel a half of the base as per image (B) to and stick with holding other half not to move. It would be good idea to stick from center towards to the edge not to allow air trapped.
 - Remove the other base sheet and then stick on the remaining part.

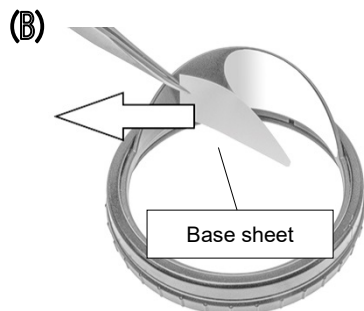
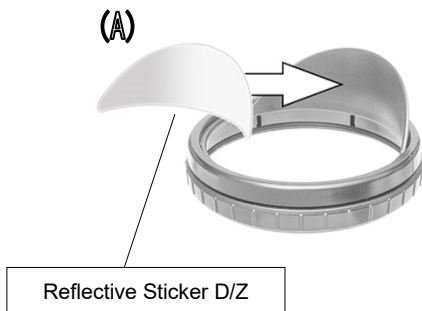

INON INC. 2-18-9 Dai, Kamakura, Kanagawa, 247-0061 Japan
 E-mail: support@inon.co.jp/Fax. +81(0)467-48-2178
 URL <http://www.inon.jp/> January 2020