

linarie

NARBONNE

60cm Canopy Rangehood

RAHT60XN

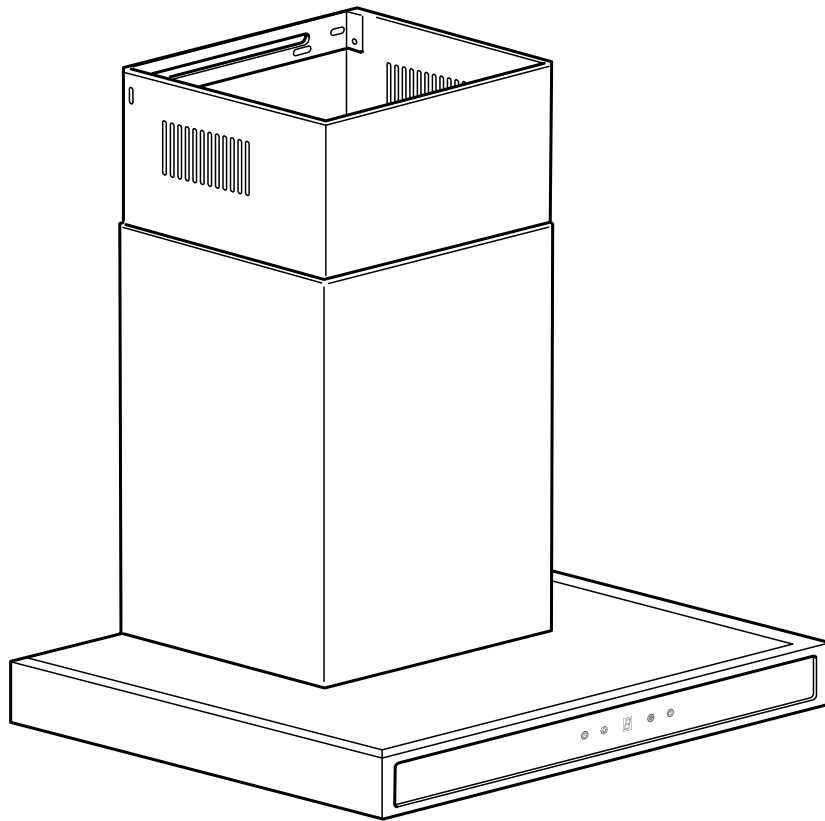

EN

Operation, Installation
& Instruction Manual

www.linarie.com.au

Register
your
product
online

CONGRATULATIONS

Congratulations and thank you for choosing Linärie to introduce a new comfort of cooking in your home. We are sure you will find your new appliance a pleasure to use and a great asset to your kitchen.

This appliance complies with all relevant safety requirements in Australia. Inappropriate use can, however, lead to personal injury and damage to property.

In order to operate the unit correctly and safely, please read this instruction manual carefully before installation and usage. This user manual which provides you with all required instructions related to safety, installation, use and maintenance of the appliance.

For future reference, please store this booklet in a safe place and ensure that all users are familiar with the contents. Pass them on to any future owner of the appliance.

Record Model & Serial Number

Model:.....

Serial Number

Register your product www.linarie.com.au

IMPORTANT

Adherence to the directions for use in this manual is extremely important for health and safety. Failure to strictly adhere to the requirements in this manual may result in personal injury, property damage and affect your ability to make a claim under Linärie's manufacturer's warranty provided with your product. Products must be used, installed and operated in accordance with this manual. You may not be able to claim on Linärie's manufacturer's warranty in the event that your product fault is due to failure to adhere this manual.

Correct Conditions of Use

- The appliance is intended for use in the home and similar environments only. It is not intended for commercial use.
- The appliance is not suitable for outdoor use, non-stationary installation (e.g. on ships, vehicles), or heating rooms.
- It must only be used to extract vapors and remove odors from cooking. Any other usage is at the owner's risk.
- Where a recirculation rangehood is fitted above a gas cooktop, please ensure that there is an adequate supply of fresh air into the room in which it is installed. Please seek the advice of a qualified gas fitter if necessary.

 Linärie does not assume any liability for damage arising from non-adherence to these documents and from improper assembly. The electricity connection must be made by a qualified specialist. Installation must comply with the valid standards, regulations and laws. All safety and warning information and the operating and installation instructions must be complied with.

TABLE OF CONTENTS

1. General Information	03	4.3 Installation tips	06
1.1 Appliance information		4.4 Installation {External Ventilation}	06
2. General Safety Instructions	03	4.5 Installation {Air extraction}	08
2.1 General safety information	03	5. Operation	08
2.2 Safety instruction - Installation	03	5.1 Control panel and function keys	08
2.3 Exhaust air Operation	04	5.2 Energy saving tips	09
2.4 Correction use & Operation	04	6. Troubleshooting	09
2.5 Disassembling and Disposal		7. Cleaning and maintenance	10
of the Appliance	05	7.1 Stainless steel	10
2.6 Accessories and Spare parts	05	7.2 Control panel	10
3. Description of the Functions	05	7.3 Cleaning agents	10
3.1 Air extraction mode	05	7.4 Aluminum grease filter	10
3.2 Recirculation mode	05	7.5 Removing the aluminum glass filter	10
3.3 Guide to the appliance	05	7.6 Activated carbon filter	11
4. Installation	06	7.7 Replacing lamps	11
4.1 Pre-installation	06	8. Environmental tips	12
4.2 Safety distance	06	9. Warranty and After sales service	12

Additional information on products, accessories, warranty, replacement parts and services can be found at www.linarie.com.au

1. GENERAL INFORMATION

1.1 Appliance Information

- A damaged appliance can be dangerous. If you find the appliance is damaged or marked, you must report it within 7 days if you wish to claim for damage/marks under the manufacturer's warranty. This does not affect your statutory rights. Do not use a damaged appliance.
- The manufacturer's warranty will be invalidated if the appliance is not repaired by a Linärie approved service technician.
- Faulty components must only be replaced by genuine Linärie spare parts. The manufacturer can only guarantee the safety of the appliance when Linärie replacement parts are used.
- If the power cord is damaged, it must only be replaced by a Linärie authorized service technician or suitably qualified electrician in order to avoid a hazard.
- Linärie cannot be held liable for noncompliance with these instructions, resulting from incorrect or improper use or operation.

2. GENERAL SAFETY INSTRUCTIONS

 The appliance complies with the stipulated safety requirements in Australia. The user is responsible for appliance cleaning and maintenance as well as its safe use. Improper use can lead to personal injury and damage to property.

2.1 General Safety Instructions

Children and People with Special Needs

WARNING

This appliance is not intended for use by persons (including children) with reduced physical, sensory or mental capabilities, or lack of experience and knowledge, unless they have been given supervision or instruction concerning use of the appliance by a person responsible for their safety.

- The appliance is NOT suitable for use by children without supervision.
- Young children should be supervised near the appliance to ensure they do not play with this appliance.
- Children may be able to wrap themselves in packing material or pull it over their heads with the risk of suffocation. Keep children away from any packing material.

Unauthorized Modifications

Unauthorised modifications can cause the appliance to pose risks. Do not conduct any modifications to the appliance.

Cleaning & Maintenance

The device must be cleaned regularly. Dirt can lead to damage or the buildup of odors. (See "Cleaning and maintenance" section).

- Always clean the appliance exactly as indicated in the operating instructions.
- Always ensure the appliance is switched off before cleaning or replacing parts.
- Clean the appliance immediately after any food spillage and the filter regularly to keep the appliance working efficiently.
- There is a risk of fire if cleaning is not carried out as described in these operating instructions.
- Make sure no water penetrates inside the device when cleaning. Do not use a steam cleaning appliance to clean this appliance. The steam could reach electrical components and cause a short circuit.
- In areas which may be subject to infestation by cockroaches or other vermin, pay particular attention to keeping the machine and its surroundings in a clean condition at all times. Any damage which may be caused by cockroaches or other vermin will not be covered by the machine warranty.

2.2 Safety Instructions - Installation

WARNING

The appliance must only be installed and assembled by trained specialists who are familiar with and comply with the standard national regulations and supplementary regulations of ventilation systems.

- In order to avoid any potential hazard, the installation instructions must be followed.
- Observe all regional regulations for the installation of ventilation systems.
- When installing the appliance, make sure that the following distances between the top of rangehood or hob and the lowest part of the cooker hood must be observed:
Gas hobs: 750mm. Electric hobs: 650mm.
- During installation, maintenance and repair work, the appliance must be disconnected from the mains electricity supply. It is only completely isolated from the electricity supply when:
 - the mains circuit breaker is switched off, or
 - it is switched off at the wall socket and the plug is withdrawn from the socket.
- Do not pull the mains connection cable but the mains plug to disconnect your appliance from the mains electricity supply.
- If the rangehood is used with cookers that burn gas or other fuels, there must be adequate ventilation in the room.
- Insufficient distance between the cooktop and the rangehood can result in damage to the rangehood.

- Ensure that all specified vents, openings and airspaces are not blocked.
- All ducting, pipework and fittings must be of non-flammable material.
- The appliance must not be connected to a chimney or vent flue which is in current use for exhausting fumes from appliances burning gas or other fuels. Neither should it be connected to ducting which ventilates rooms with fireplaces.
- Do not connect the appliance to the mains electricity supply by a multi-socket unit or an extension lead. Extension leads are a fire hazard and do not guarantee the required safety of the appliance.
- Tampering with electrical connections or components and mechanical parts is highly dangerous to the user and can cause operational faults. Only open the housing as described in the instructions given in "Installation" and in the "Cleaning & Maintenance" sections of this booklet. Under no circumstances should any other parts of the housing be opened.
- **THIS APPLIANCE MUST BE PROPERLY EARTHED.** It is most important that this basic safety requirement is present and tested regularly and, where there is any doubt, the household wiring system should be inspected by a qualified electrician.
- Linärie cannot be held liable for noncompliance with these instructions, resulting from incorrect or improper use or operation.

2.3 Exhaust Air Operation

 WARNING
<p>Danger of poisoning from recirculated exhaust gases! Do not operate the appliance in extract air mode if it is operated together with a room air-dependent fireplace and sufficient air circulation is not guaranteed.</p>

Safe operation is only possible if the negative pressure at the location of the fireplace does not exceed 4 Pa (0.04 mbar). This can be achieved if the air required for combustion can flow in through non-closable openings in doors and windows in conjunction with a supply air / exhaust air wall box. In any case, have a master chimney sweep advise you and assess the entire ventilation system of the house. If necessary, they can tell you the necessary measure for ventilation.

If the rangehood is used exclusively in recirculation mode, where the air is directed back into the room in which it is located, operating a heating appliance which depends on the room air at the same time is not hazardous.

Room air-dependent fireplaces such as gas, oil, wood or coal heaters, boilers or instantaneous water heaters draw the air from the room and lead it outdoors through an exhaust pipe or chimney. In extract air mode, air is extracted from the kitchen and neighbouring rooms. Without sufficient supply air, negative pressure is created. The heating appliance will be starved of oxygen, impairing combustion. Toxic gases from the chimney or exhaust pipe can be sucked back into the living rooms.

- Make sure that sufficient fresh air supply is guaranteed and that the air can circulate.
- A supply air/exhaust air wall box is not sufficient to ensure compliance with the limit value.

2.4 Correction Use & Operation

- For safety reasons, this appliance may only be used after it has been built in.
- Reliable and safe operation of this rangehood can only be assured if it has been connected to the mains electricity supply.
- Before using the appliance, ensure that all packaging materials are removed from the appliance and make sure that the connection data on the data plate [voltage (V) and frequency (Hz)] indicated on the rangehood correspond to the voltage and frequency of the power supply in your household. Consult a qualified electrician if in doubt.
- **DO NOT** use the rangehood without the filters in place. This way you will avoid the risk of grease and dirt getting into the appliance and hindering its smooth operation.
- Never use an open flame beneath the rangehood. To avoid the danger of fire, do not flambé or grill over an open flame. When switched on, the rangehood could draw flames into the filter. Fat deposits could ignite, presenting a fire hazard.
- **DO NOT** store or spray flammable materials in the appliance or near this appliance while it is in operation (e.g. aerosols).

- The rangehood can become damaged when exposed to excessive heat.
 - Select a pan which is suitable for the size of the burner.
 - Regulate the flame so that it does not burn up the sides of the pan.
 - Avoid overheating the pan (e.g. when cooking with a wok).
- Always switch the rangehood on when a cooking zone is in use, otherwise condensation may collect in the rangehood, which could cause corrosion. When cooking with oil or fat, chip pans and deep fat fryers etc., do not leave the pans unattended. Never leave an open grill unattended when grilling.
- Overheated oil and fat can ignite and could set the rangehood on fire.

 CAUTION
<p>The rangehood can get very hot during cooking due to heat rising from the cooktop. Do not touch the housing or the grease filters until the rangehood has cooled down.</p>

2.5 Disassembling and Disposal of the Appliance

(see the “Environmental Tips” section for best practices on disposing of this appliance).

The device must only be disassembled by trained specialists who are familiar with and comply with the standard national regulations and supplementary regulations of the local utility companies.

Work on electrical components must only be conducted by trained electrical personnel.

2.6 Accessories and Spare parts

Incorrect components can lead to personal injury or damage to the appliance. Only use original Linärie spare parts for repairs.

Modifications, additions or alterations to the appliance can lead to safety risks. If spare parts or accessories from other manufacturers are used, the warranty will be invalidated, and Linärie cannot accept liability.

Please check www.linarie.com.au for more information.

3. DESCRIPTION OF THE FUNCTIONS

Depending on the model of the rangehood, the following options are available:

3.1 Air extraction mode

The air is drawn in and cleaned by the grease filter and directed outside.

Non-return flap

The non-return flap is designed to prevent the exchange of room and outside air taking place. The flap is closed when the rangehood is switched off. When the rangehood is switched on, the non-return flap opens for the cooking vapors to be blown directly outside. If the on-site ventilation system does not have a non-return flap, the nonreturn flap supplied must be fitted.

3.2 Recirculation mode

- The air is drawn in and cleaned first by the grease filter and then by a charcoal filter. The cleaned air is then recirculated back into the kitchen.
- When using recirculation mode, ensure a sufficient supply of fresh air, e.g. by opening a window.

- Ensure a normal and comfortable room climate (humidity of 45–60%), e.g. by opening natural ventilation openings or using domestic ventilation systems.
- After every use in recirculation mode, switch the rangehood to a low level for about 15 minutes.

3.3 Guide to the appliance

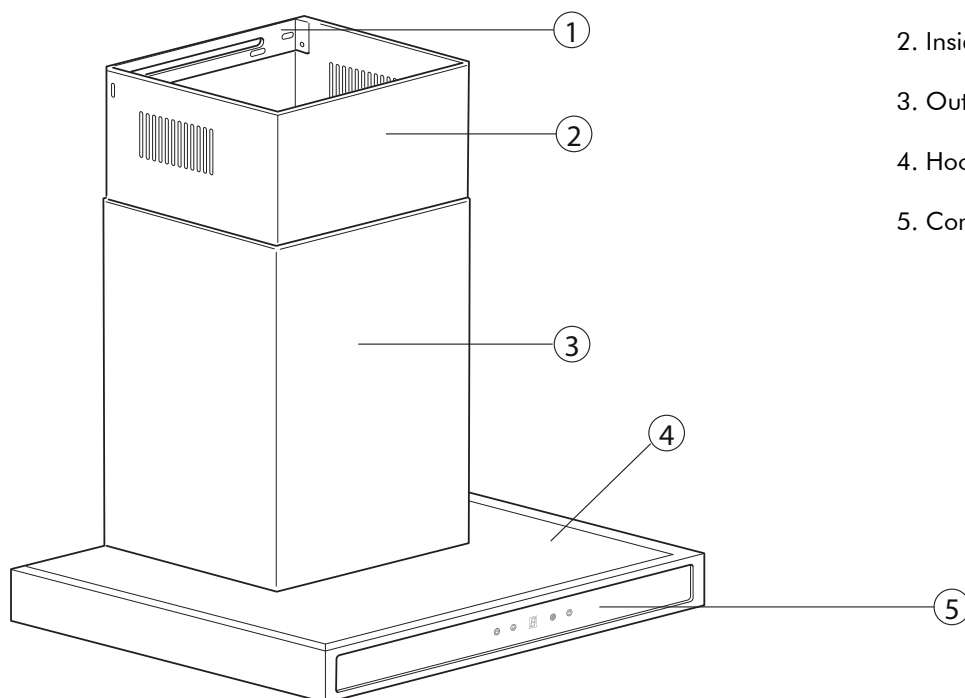

1. Inside chimney bracket
2. Inside chimney
3. Outside chimney
4. Hood
5. Control panel

4. INSTALLATION

WARNNG

Before installation, it is important to read the information given on the following pages as well as the "General Safety Instructions" at the beginning of this booklet. Failure to install the appliance correctly could invalidate any warranty or liability claims and lead to prosecution.

4.1 Pre-Installation

Before installing the rangehood, peel off any protective plastic covering and remove polystyrene from inside behind the fan motor.

4.2 Safety Distance

WARNNG

If you are fitting a front panel made of wood or plastic to the rangehood, observe the safety distances given by the cooktop manufacturer regarding the use of easily flammable materials.

Before installation, turn the unit off and unplug it from the outlet. The rangehood should be placed at a distance of 65~75cm above the cooking surface for best effect.

WARNNG

- For safety reason, please use only the same size of fixing or mounting screws which are recommended in this instruction manual.
- Failure to install the screws or fixing device in accordance with these instructions may result in electrical hazards.

4.3. Installation Tips

GENERAL INFORMATION

- To achieve optimum vapor extraction, the rangehood must cover the cooktop. It should be positioned centrally over the cooktop, not to the side.
- The cooktop should be no wider than the rangehood and, if possible, it should be narrower, especially for safety distances greater than 750 mm.
- The installation area must be easily accessible. The rangehood should be easily accessible and easy to dismantle in the event that service is required. This should be taken into consideration when planning the position of cupboards, shelves, ceilings or features in the vicinity of the rangehood.

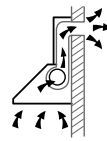

If you have an air outlet to the outside, the rangehood can be connected via an extraction duct (enamel, aluminium, flexible pipe or non-combustible material with an internal diameter of 150 mm) as shown on the left.

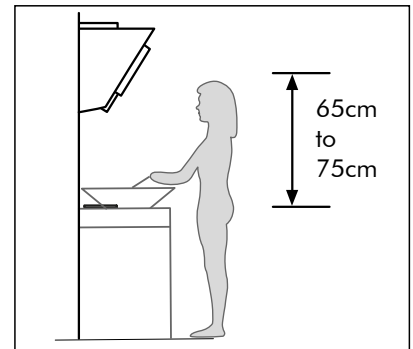

4.4 Installation [External Ventilation]

Mounting of V-flap

If the rangehood does not have a pre-assembled V-flap, install the parts as follows:

1. Install the first half into the housing
2. The pin should be facing upwards.
3. The axle is inserted into the holes on the housing.
4. Repeat all the steps for the second half of the flap.

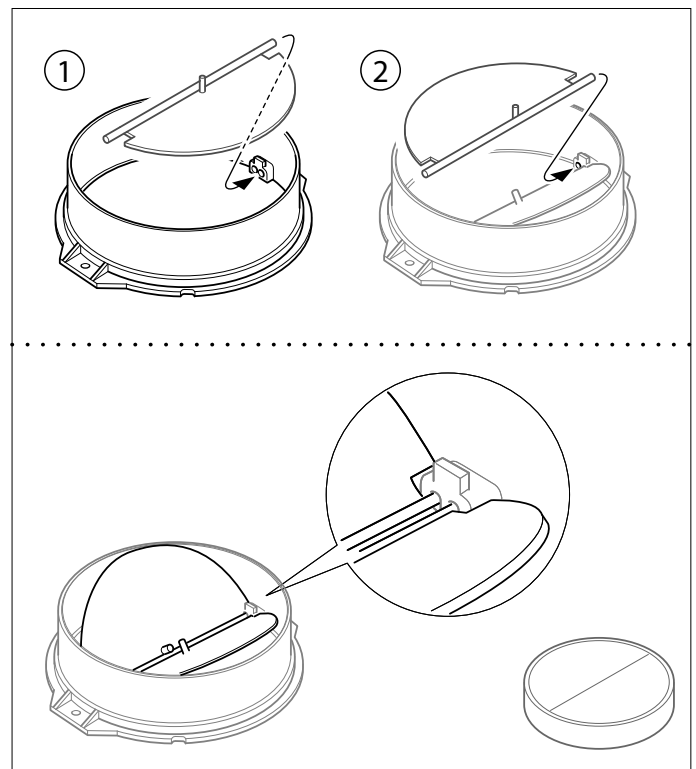
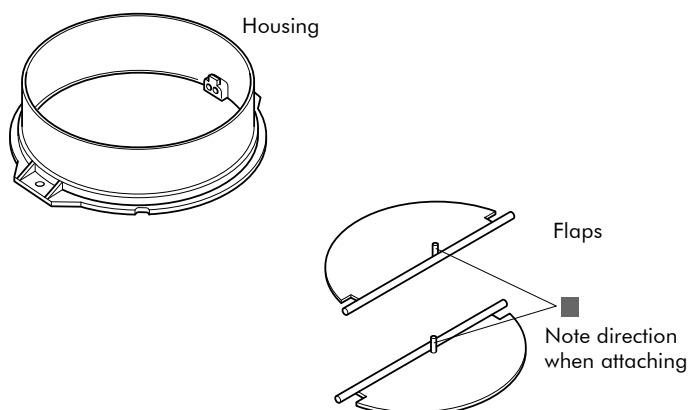

cont. installation

- 1** Drill 5 x 8mm holes in the wall where you want to mount the wall bracket. Secure it using the screws and dowels provided.

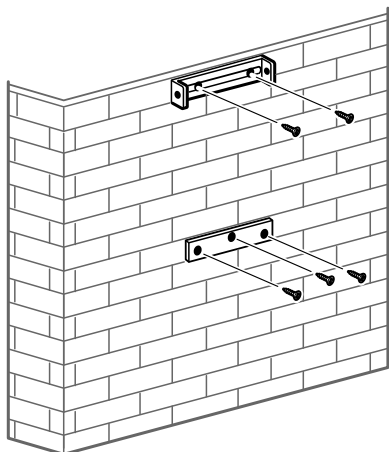

- 2** Connect the exhaust duct and the V-shaped flap to the hood.

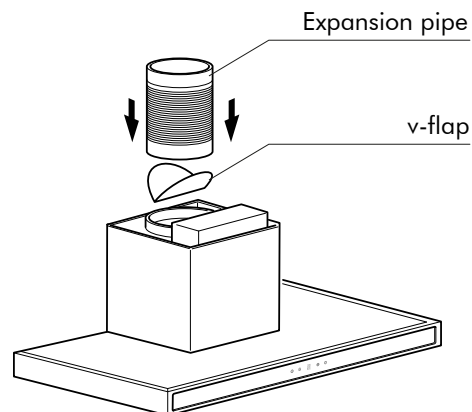

- 3** Lift the hood and hang it on the wall bracket.

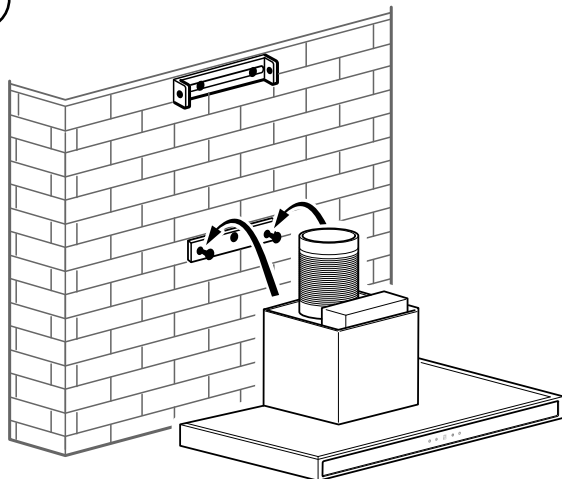

- 4** Install the outside chimney bracket into the outside chimney with 2 ST 4x8mm screws. Ensure that the inside chimney can move freely.

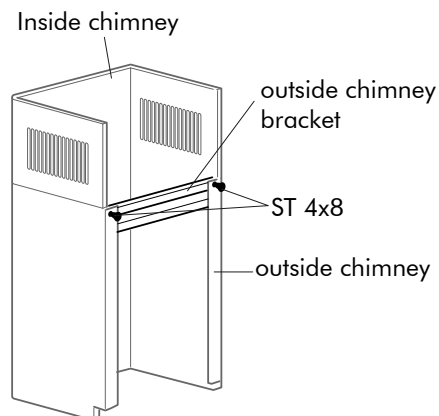

- 5** Slide the upper part of the chimney inside the part lower part, then pull the upper part up to the height desired. Attach 2 x Security Screws (4mm x 30mm) to the back of the 6mm thick diameter.

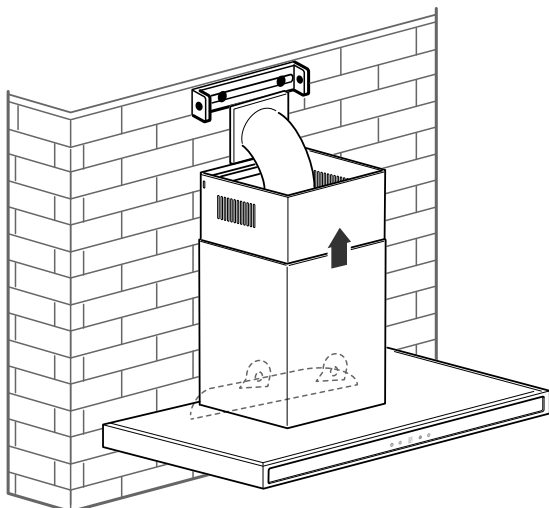

- 6** Mount the chimney on the hood then fix them together with 2 screws.

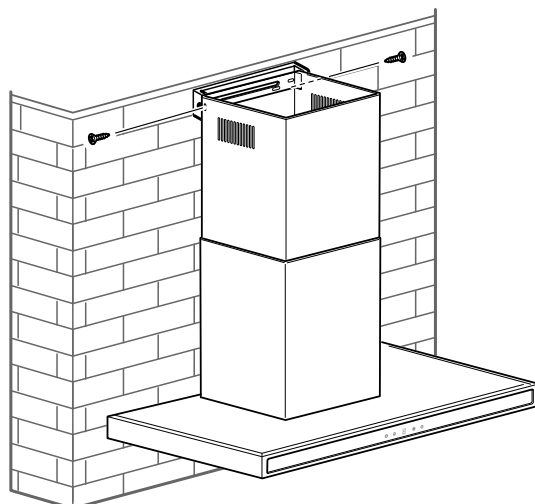

cont. installation

4.5 Installation [Air Extraction]

CAUTION

- Before installation, it is important to read the information given on the "Warning and Safety instructions" section at the beginning of this booklet. This is particularly crucial when using the rangehood at the same time as a heating appliance that relies on oxygen from the same room, which could result in the build-up of toxic fumes.
- The rangehood should be installed according to local and national building regulations. Seek approval from the building inspector where necessary.

CAUTION

Risk of injury! For safety reasons, only use the size of fastening or mounting screw recommended in these operating instructions. Non-compliance with these instructions can lead to injuries and electric shocks.

NOTE

Remember that any constriction of the airflow will reduce extraction performance and increase operating noise.

The following rules must be strictly observed to achieve optimum air extraction.

- Make sure that the exhaust pipe extends as short and straight as possible.
 - Do not reduce the size or restrict the exhaust pipe. When using exhaust air pipes, always install the pipe tightly to minimise pressure loss.
 - Non-compliance with these basic instructions will reduce the performance and increase the noise level of the rangehood.
 - All installation work must be carried out by an electrician or a qualified person.
- Do not connect the exhaust pipe of the rangehood to an existing ventilation system used for another appliance, e.g. a flue, gas pipes or hot air pipes.
 - In case the exhaust air pipe is bent, the angle of the exhaust air pipe should not be less than 120°. Never point the exhaust air pipe downwards, but always horizontally or guide the pipe from the starting point upwards to the air outlet on the outside wall.
 - After installation, please make sure that the rangehood is positioned horizontally to prevent grease from accumulating.
 - Make sure that the exhaust pipe selected for installation complies with the relevant standards and is fire-retardant.

5. OPERATION

5.1 Control panel and function keys

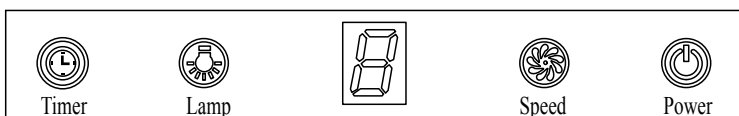

1. Power button

The button control the "on" & "off" of the hood.



2. Speed button

By pressing the "Speed" button, the motor runs the low / mid / high / low / mid motion. The speed runs in circulation mode; and the LED display will also indicate in 1-2-3-1-2 motion.



3. Lamp button



By press "Lamp" button, the light illuminates. Press this button again, and the light will turn off. Please note that the Lamp is not under control of the On/Off button.





4. Timer button

When the hood is working, by pressing the "Timer" button, the hood will go into the status of acquiescent working (acquiescent time is 9mins), and then, the LED display will be shown 9.8.7.6. decreasing by 1. When time is up, the hood will be off automatically and the lamp will switch off. By pressing "Timer" button, the hood will be in IN or Out "Timer" function.

5. Gesture sensor mode:

5.1 Wave your hand from left to right once within 8cm from the front of the sensor, the rangehood will start to work at low speed and the LED display will show "1". The light will lit on. The indicator lights of the  (Power) button,  (Speed) button and  (Lamp) button will be on. Wave your hand from left to right again, the rangehood works at medium speed and the LED display will show "2". Wave your hand in the same direction as above for another time, the rangehood works at high speed and the LED display will show "3". Wave your hand in the same way again when the hood works at the highest speed, the hood will work at the same speed.

5.2 When wave your hand from right to left once, the cooker hood will shift to a lower speed. Wave your hand from right to left when the hood works at high speed, the cooker hood will switch to medium speed. The indicator light of the  (Lamp) button,  (Speed) button and  (Power) button will be on. Wave your hand from right to left when the hood works at medium speed, the cooker hood will switch to low speed. The LED display will show current speed level. If continuously reducing to no speed, the indicator lights will be off and all the function operation of the hood will not be available. The hood will then enter standby mode. The above steps can be operated repeatedly.

5.3 If without any operation for functional buttons, the gesture sensor will enter sleeping mode after 10 minutes. Re-awake gesture function requires manual operation of any function buttons. The gesture function can be operated only when it has been activated.

In addition, in order to improve the quality of air treatment, we advise you to turn on your hood a few minutes before cooking, this will create a furrow and bring the unfiltered air back to the hood the first time. Please do not open any window or door when using, it will lose the furrow and efficiency of the hood.

cont. operation

5.2 Energy Saving tips

This rangehood operates very efficiently and economically. The following will help you to save even more energy when using it:

- Ensure that there is sufficient ventilation in the kitchen when cooking. In extraction mode, if there is insufficient air flow the rangehood cannot operate efficiently and this causes increased operating noise levels.
- Always cook with the lowest possible setting. This produces fewer cooking vapors, so you can use a lower rangehood power level and therefore benefit from reduced energy consumption.
- Check the power level selected on the rangehood. A lower power level is generally sufficient for the majority of cooking.
- When a large volume of cooking vapors is being produced, switch to a high-power level in good time. This is more efficient than operating the rangehood for longer to try to capture cooking vapors which have already been distributed throughout the kitchen.
- Make sure that you switch the rangehood off after use.
- Clean or change the filters at regular intervals. Heavily soiled filters reduce performance, increase the risk of fire and are unhygienic.

6. TROUBLESHOOTING

Observe all safety and warning information during operation. (see the General Safety Instructions" section)

Problem	Possible Cause	Possible Solution
Lights on, but motor does not work.	Fan switch has turned off.	Select a fan switch position.
	Fan switch has failed.	Contact service center.
	Motor has failed.	Contact service center.
Light does not work, motor does not work.	House fuses has blown.	Select a fan switch position.
	Mains power cable is loose or disconnected.	Remove and reattach mains power cable to power outlet. Switch power outlet on.
Oil leakage.	One way valve and the outlet are not tightly sealed.	Take down the one way valve and seal with sealant.
	Leakage from the connection of chimney and cover.	Take chimney down and seal.
Lights not working.	Broken or faulty bulbs.	Replace bulbs following this instruction manual.
Insufficient suction.	The distance between the rangehood and the gas top is too far.	Realign and refit the rangehood to the correct distance.
The rangehood inclines.	The fixing screw is not tight enough.	Tighten the hanging screw and make it horizontal.

WARNING

Any electrical repairs to this appliance must conform to your local, state and federal laws. Please contact the service center if in any doubt before undertaking any of the above. Always disconnect the unit from the power source when opening the unit.

7. CLEANING & MAINTENANCE

GENERAL INFORMATION

- Allow the appliance to cool down completely before cleaning and maintenance.
- The surfaces and controls are susceptible to scratches and abrasion. Please observe the following cleaning instructions.

7.1 Stainless steel

- The stainless steel must be cleaned regularly (weekly) to ensure a long service life. Stainless steel surfaces can be cleaned with a proprietary nonabrasive cleaning agent designed specifically for use on stainless steel.

7.2 Control panel

- The control panel can be cleaned with warm soapy water. Make sure the cloth is clean and thoroughly wrung out before cleaning the control panel. Use a dry, soft cloth to remove excess moisture after cleaning.

WARNING

Observe all safety and warning information during operation (see the "General Safety Instructions" section). Before maintenance or cleaning, the rangehood should always be disconnected from the power supply. Make sure that the rangehood is switched off and the plug has been removed. Exterior surfaces are prone to scratches and dents. Therefore, please follow the cleaning instructions to achieve the best possible result without damage.

7.3 Cleaning agents

WARNING

Do not use stainless steel cleaning agents on the controls. Use neutral cleaning agents and avoid using harsh cleaning chemicals, strong household cleaners or products containing abrasive cleaners as this will affect the appearance of the appliance and may remove the printed symbols on the control panel.

7.4 Aluminum grease filter

WARNING

An oversaturated filter is a fire hazard. The aluminum grease filter in the appliance removes solid particles from the kitchen vapors, grease, dust, etc., therefore, preventing soiling of the rangehood.

Grease filter cleaning intervals

- The grease filter should be cleaned regularly (at least every 3-4 weeks) to avoid a build-up of grease

Cleaning the grease filter by hand

- The reusable aluminum filter can be cleaned by hand. Soak them in water together with a grease-dissolving detergent for about 3 minutes and then brush them gently with a soft brush. Do not apply too much pressure to avoid damaging the filter. Allow the filter to air dry afterwards, but do not place it directly in the sun. Filters should always be washed separately from crockery and kitchen utensils!

7.5 Removing the aluminum grease filter

- Removing the filters as the instruction in Pic. 10.
- You can clean the filter as below measure:
- Soak them for about 3 minute in hot water (40-50 degrees) with a grease-loosening detergent then brush it gently with a soft brush.
- Please do not apply too much pressure, avoid damaging it. Please do not use abrasive detergent for it will damage the hood.
- Make sure that the hood is shut off before cleaning.

Remove the filter as shown in the image below and reinsert the filter in reverse order.

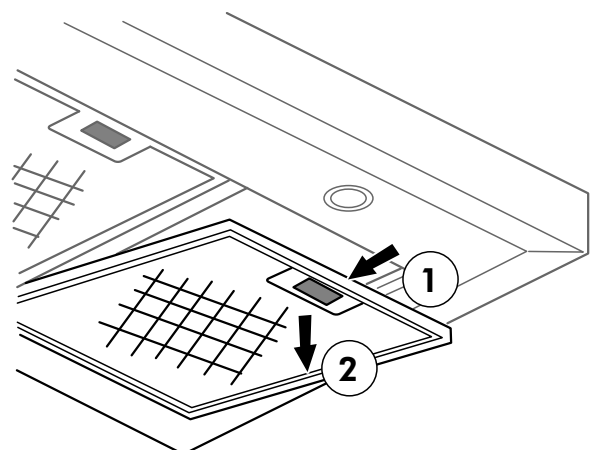

When handling a grease filter, be careful not to drop it. This can result in damage to the filter and the cooktop below. Make sure you hold the filter securely at all times when handling it.

cont. cleaning and maintenance

7.6 Activated carbon filter

If the rangehood is connected for recirculation, a charcoal filter must be inserted in addition to the grease filter. This is designed to absorb cooking odors.

Installing and replacing the activated charcoal filter

The installation of the activated carbon filter is done as follows:

First, remove the grease filter by pulling it down after having unblocked.

Mount the charcoal filter on the hood by turning it clockwise. Do the same for the second filter.

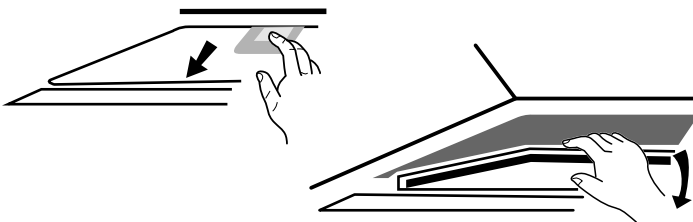

1. Remove the filters.
2. The charcoal filters (right image) are located at both end of the motor. Turn the charcoal filters until they are unscrewed.
3. Apply reverse procedure to uninstall the charcoal filter.

Warning: the charcoal filter cannot be washed or recycled. It should be replaced after approximately 120 hours of use.

! WARNING

Make sure that the filter is tightly closed. It can otherwise detach and become dangerous. If an activated carbon filter is connected, the suction power is reduced.

When to change the activated charcoal filter?

The activated charcoal filter should be changed after 3 to 6 months, depending on your cooking habits. Allow the appliance to cool down completely before maintenance. Replacement charcoal filters can be obtained from www.linarie.com.au

Disposing of the activated charcoal filter

The used activated charcoal filter can be disposed with the normal household waste.

Charcoal filter

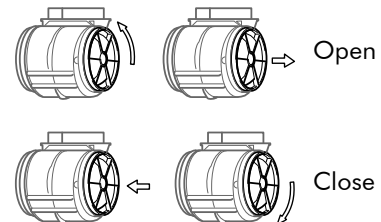

Replace filter on both sides

7.7 Replacing the lamps

Observe all safety and warning information during operation (see the "General Safety Instructions" section).

The lamps should be replaced with the following:

ILCOS D code: DSR-1.5-65-S-64

LED Type: Self-ballasted - round lamp

Max wattage: 1.5W

Voltage range: DC 12v

Dimensions: 64mm

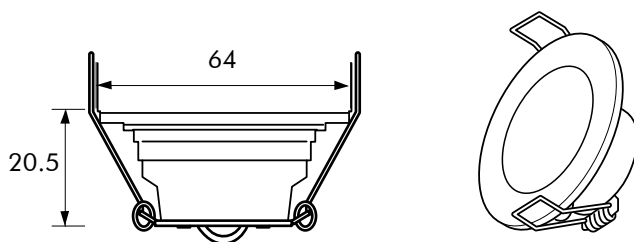

! WARNING

- The lamps become hot when in use. Allow the lamps to cool down completely before changing them.
- The lamp must be replaced by the manufacturer, its after-sales service or similarly qualified persons.
- Always switch off the power supply before carrying out any work on the appliance.
- Always hold the lamp with a cloth or gloves when inserting or removing it to ensure that sweat does not come into contact with the lamp, as this can reduce its life.

8. ENVIRONMENTAL TIPS

Observe all safety and warning information during operation (see the "General Safety Instructions" section).

8.1 Disposal considerations

The transport and protective packaging has been selected from materials which are environmentally friendly for disposal, and can normally be recycled.

Recycling the packaging reduces the use of raw materials in the manufacturing process and also reduces the amount of waste in landfill sites. Ensure that any plastic wrappings, bags etc. are disposed of safely and kept out of the reach of babies and young children. Danger of suffocation.



8.2 Disposing of your old appliance

Electrical devices marked with this label may not be disposed of in domestic waste at the end of their service life.

Electrical and electronic appliances often contain valuable materials. They also contain specific materials, compounds and components, which were essential for their correct function and safety. These could be hazardous to human health and to the environment if disposed of with your domestic waste or if handled incorrectly. Please do not, therefore, dispose of your old appliance with your household waste.

Please dispose of those materials by contacting your local authorities and ask for the correct method of disposal. Please ensure that your old appliance poses no risk to children while being stored prior to disposal.

By disposing of this product in accordance with the regulations, you protect the environment and the health of those around you from negative consequences.

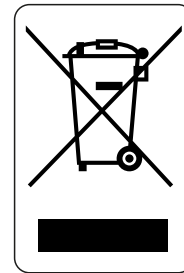

9. WARRANTY & AFTER SALES SERVICE

Observe all safety and warning information during operation (see the "General Safety Instructions" section).

In the event of a fault which you cannot remedy yourself, please contact Linärie.

9.1 Warranty

The manufacturer's warranty for this appliance is 2 years.

9.2 After sales service

The contact details for Linärie are given at the beginning and of these instructions.

When contacting Linärie, please quote the model and serial number of your appliance. These can be found on the data plate, after removing the grease filter.

Record model & serial number

Model:.....

Serial Number:.....

Register your product www.linarie.com.au

9.3 Replacement of spare parts

Incorrect components can lead to personal injury or damage to the appliance. Use only genuine original Linärie spare parts.



Modifications, additions or alterations to the appliance can lead to safety risks. If spare parts or accessories from other manufacturers are used, the warranty will be invalidated, and Linärie cannot accept liability.

Please check www.linarie.com.au for more information.

LIKE TO KNOW MORE?

For further information on all Linärie appliances,
or to obtain detailed dimension and installation
information, phone or email our Customer Care
team or visit our website:

Australia
hello@linarie.com.au
www.linarie.com.au

Follow Us
[@Linarie.Appliances](#)
  

Operating and installation instructions:

Original

√ Translation

Mart Online Services Pty Ltd.
ACN 657 824 050

Linärie Contact
hello@linarie.com.au
www.linarie.com.au

The distribution and duplication of this document, as well as the use and disclosure of its contents are prohibited unless expressly authorised.

These operating and installation instructions have been drawn up with the greatest of care. But it cannot be ruled out that subsequent technical modifications have not yet been incorporated or the relevant content has not yet been adapted. Please accept our apologies in this eventuality. An updated version can be requested from our team. Subject to printing errors and mistakes.

© Linärie

All rights reserved.