

linarie

CHATEL

Retro Mini Fridge

with Built in Freezer compartment

LK48MBRED • LK48MBGREEN

LK48MBPINK • LK48MBBLACK

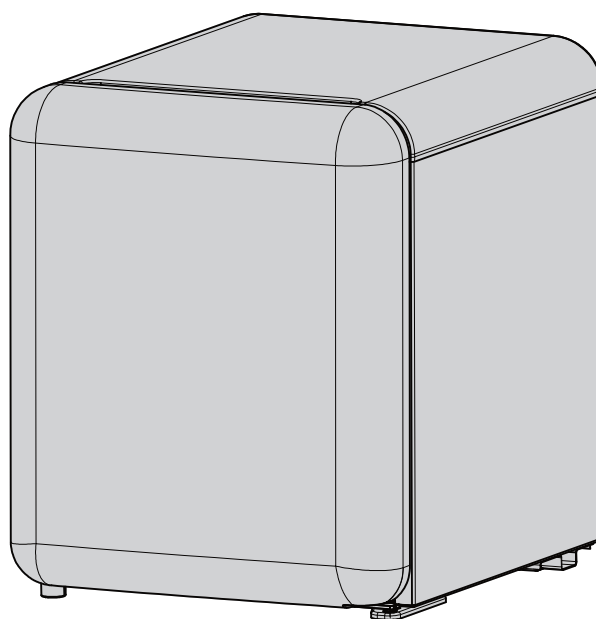

EN Operation, Installation
& Instruction Manual

www.linarie.com.au

Register
your
product
online

CONGRATULATIONS

Congratulations and thank you for choosing Linärie to introduce a new comfort of cooking in your home. We are sure you will find your new appliance a pleasure to use and a great asset to your kitchen.

This appliance complies with all relevant safety requirements in Australia. Inappropriate use can, however, lead to personal injury and damage to property.

In order to operate the unit correctly and safely, please read this instruction manual carefully before installation and usage. This user manual which provides you with all required instructions related to safety, installation, use and maintenance of the appliance.

For future reference, please store this booklet in a safe place and ensure that all users are familiar with the contents. Pass them on to any future owner of the appliance.

Record Model & Serial Number

Model:.....

Serial Number

Register your product www.linarie.com.au

IMPORTANT

Adherence to the directions for use in this manual is extremely important for health and safety. Failure to strictly adhere to the requirements in this manual may result in personal injury, property damage and affect your ability to make a claim under Linärie's manufacturer's warranty provided with your product. Products must be used, installed and operated in accordance with this manual. You may not be able to claim on Linärie's manufacturer's warranty in the event that your product fault is due to failure to adhere this manual.

Correct Conditions of Use

- The appliance is intended for use in the home and similar environments only. It is not intended for commercial use.
- The appliance is not suitable for outdoor use, non-stationary installation.
- This product is use in storing and keeping your food and drinks safe and fresh.

 The electricity connection must be made by a qualified specialist. Installation must comply with the valid standards, regulations and laws. All safety and warning information and the operating and installation instructions must be complied with.

TABLE OF CONTENTS

1. General Information	03	10. Defrosting	07
1.1 Appliance information		11. Helpful hints and tips	07
2. General Safety Instructions	03	12. Cleaning and care	08
2.1 General safety information		13. Energy saving tips	08
2.2 Safety instruction - Installation		14. Troubleshooting	09
2.3 Correction use & Operation	04	15. Environmental tips	10
2.4 Disassembling and Disposal of the Appliance		15.1 Disposal considerations	
2.5 Accessories and Spare parts		15.2 Disposing your old appliance	
3. Technical data sheet	05	16. Warranty and After sales	10
4. Structure illustration	05	16.1 Warranty	
5. Transport and handing	05	16.2 After sales service	
6. Door alignment	05	16.3 Replacement of spare parts	
7. Starting your new retro mini fridge	05		
8. Operation	06		
8.1 First use			
8.2 Temperature control			
9. Storage of food	06		

Additional information on products, accessories, warranty, replacement parts and services can be found at www.linarie.com.au

1. GENERAL INFORMATION

1.1 Appliance Information

- A damaged appliance can be dangerous. If you find the appliance is damaged or marked, you must report it within 7 days if you wish to claim for damage/marks under the manufacturer's warranty. This does not affect your statutory rights. Do not use a damaged appliance.
- The manufacturer's warranty will be invalidated if the appliance is not repaired by a Linärie approved service technician.
- Faulty components must only be replaced by genuine Linärie spare parts. The manufacturer can only guarantee the safety of the appliance when Linärie replacement parts are used.
- If the power cord is damaged, it must only be replaced by a Linärie authorized service technician or suitably qualified electrician in order to avoid a hazard.
- Linärie cannot be held liable for noncompliance with these instructions, resulting from incorrect or improper use or operation.

2. GENERAL SAFETY INSTRUCTIONS

 The appliance complies with the stipulated safety requirements in Australia. The user is responsible for appliance cleaning and maintenance as well as its safe use. Improper use can lead to personal injury and damage to property.

2.1 General Safety Instructions

Children and People with Special Needs

WARNING

This appliance is not intended for use by persons (including children) with reduced physical, sensory or mental capabilities, or lack of experience and knowledge, unless they have been given supervision or instruction concerning use of the appliance by a person responsible for their safety.

- The appliance is NOT suitable for use by children without supervision.
- Young children should be supervised near the appliance to ensure they do not play with this appliance.
- Children may be able to wrap themselves in packing material or pull it over their heads with the risk of suffocation. Keep children away from any packing material.

Unauthorized Modifications

Unauthorised modifications can cause the appliance to pose risks. Do not conduct any modifications to the appliance.

Cleaning & Maintenance

The device must be cleaned regularly. Dirt can lead to damage or the buildup of odors. (See "Cleaning and maintenance" section).

- Always clean the appliance exactly as indicated in the operating instructions.
- Always ensure the appliance is switched off before cleaning or replacing parts.
- Clean the appliance immediately after any food spillage and the filter regularly to keep the appliance working efficiently.
- There is a risk of fire if cleaning is not carried out as described in these operating instructions.
- Make sure no water penetrates inside the device when cleaning. Do not use a steam cleaning appliance to clean this appliance. The steam could reach electrical components and cause a short circuit.
- In areas which may be subject to infestation by cockroaches or other vermin, pay particular attention to keeping the machine and its surroundings in a clean condition at all times. Any damage which may be caused by cockroaches or other vermin will not be covered by the machine warranty.

2.2 Safety Instructions - Installation

WARNING

The appliance must only be installed and assembled by trained specialists who are familiar with and comply with the standard national regulations and supplementary regulations of ventilation systems.

- In order to avoid any potential hazard, the installation instructions must be followed.
- Observe all regional regulations for the installation of ventilation systems.
- During installation, maintenance and repair work, the appliance must be disconnected from the mains electricity supply. It is only completely isolated from the electricity supply when:
 - the mains circuit breaker is switched off, or
 - it is switched off at the wall socket and the plug is withdrawn from the socket.

- Do not pull the mains connection cable but the mains plug to disconnect your appliance from the mains electricity supply.
- Do not connect the appliance to the mains electricity supply by a multi-socket unit or an extension lead.
- Extension leads are a fire hazard and do not guarantee the required safety of the appliance.
- Tampering with electrical connections or components and mechanical parts is highly dangerous to the user and can cause operational faults. Only open the housing as described in the instructions given in "Installation" and in the "Cleaning & Maintenance" sections of this booklet. Under no circumstances should any other parts of the housing be opened.
- The electrical requirements are 220-240 volts, 50Hz AC only at 10amp. It is recommended that a separate circuit, serving only the product be provided.

- THIS APPLIANCE MUST BE PROPERLY EARTHED. It is most important that this basic safety requirement is present and tested regularly and, where there is any doubt, the household wiring system should be inspected

by a qualified electrician. Linärie cannot be held liable for noncompliance with these instructions, resulting from incorrect or improper use or operation.

- Due to the special characteristics of the tempered glass, the tempered glass may be exploded at the probability rate of 3‰- 5‰ according to the industrial estimate, while this company will strictly control it within 3‰.

- Regarding the information pertaining to the installation, handling, maintenance, servicing and disposal of the appliance, thanks to refer to the paragraph "TRANSPORT AND HANDLING" "INSTALLATION" "CLEANING AND CARE" "TROUBLESHOOTING" of the manual.

2.3 Correct use and Operation

- For safety reasons, this appliance may only be used after it has been built in.
- Reliable and safe operation of this appliance can only be assured if it has been connected to the mains electricity supply.
- Before using the appliance, ensure that all packaging materials are removed from the appliance and make sure that the connection data on the data plate [voltage (V) and frequency (Hz)] indicated on the appliance corresponds to the voltage and frequency of the power supply in your household. Consult a qualified electrician if in doubt.
- DO NOT store or spray flammable materials in the appliance or near this appliance while it is in operation (e.g. aerosols).
- Cracks, fissures or fractures in the glass ceramic panels can damage the underlying electronics. Switch off and disconnect the appliance immediately.

- Prevent water ingress. Never sprinkle or flush the cooler using water, nor place the cooler in an area exposed to moisture or water sprinkling, let alone filling the cooler with water, so as to avoid impairment of the electric insulativity of the cooler. Furthermore, failing to follow such requirements may lead to electric shock and fire, or other accidents.
- After the cooler is put into operation, never touch its inner icing surface, especially when your hand is wet; otherwise the skin may stick onto the inner surface to get injured.
- Opening the door for long periods can cause a significant increase of the temperature in the compartments of the appliance.
- Clean regularly surfaces that can come in contact with food and accessible drainage systems. If the refrigerating appliance is left empty for long periods, switch off, defrost, clean, dry, and leave the door open to prevent mould developing within the appliance.

WARNING

The refrigerant isobutane (R600a) is contained within the refrigerant circuit of the appliance, a natural gas with a high level of environmental compatibility, which is nevertheless flammable. During transportation and installation of the appliance, ensure that none of the components of the refrigerant circuit becomes damaged.

2.4 Disassembling and Disposal of the Appliance

(see the "Environmental Tips" section for best practices on disposing of this appliance).

The device must only be disassembled by trained specialists who are familiar with and comply with the standard national regulations and supplementary regulations of the local utility companies.

Work on electrical components must only be conducted by trained electrical personnel.

2.5 Accessories and Spare parts

Incorrect components can lead to personal injury or damage to the appliance. Only use original Linärie spare parts for repairs.

Modifications, additions or alterations to the appliance can lead to safety risks. If spare parts or accessories from other manufacturers are used, the warranty will be invalidated, and Linärie cannot accept liability.

Please check www.linarie.com.au for more information.

3. TECHNICAL DATA SHEET

Reference:	LK48MBRED/ LK48MBGREEN/ LK48MBBLACK/ LK48MBPINK
Rated voltage:	220-240V
Ampere:	0.6A
Rated frequency:	50Hz

Climate class:	SN/ N/ ST
Refrigerant:	R600a(18g)
Noise level:	<42db
Weight:	15kg
Dimensions:	448(W) x 543(H) x 493(D)mm

4. STRUCTURE ILLUSTRATION

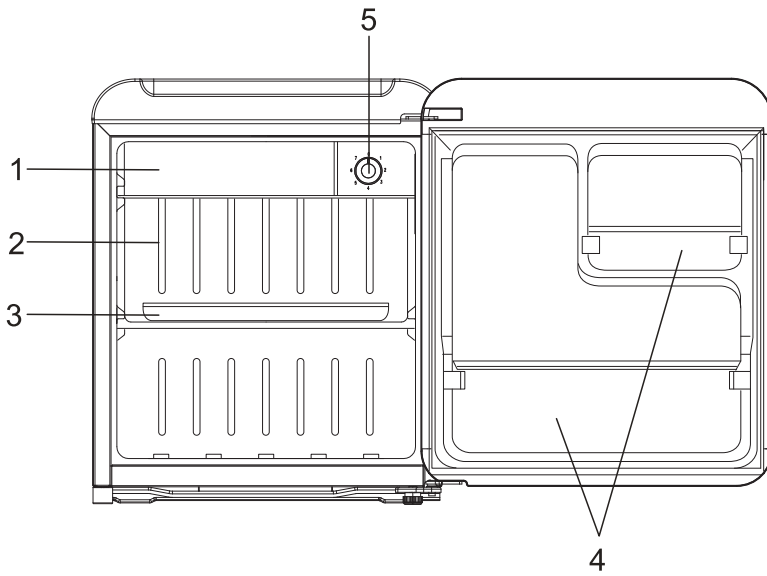

1. Ice compartment
2. Drip tray
3. Shelving
4. Bottle racks
5. Defrost button

5. TRANSPORT AND HANDING

When transportation, hold the base and lift the refrigerator carefully with an angle inferior at 45 degree. Never hold the door handle as support. Never place it upside down nor horizontally. Push refrigerator on its basis and place it thanks to its roller feet.

6. DOOR ALIGNMENT

1. Remove the top hinge cover.
2. Loosen the top hinge screws using Phillips head screw driver.
3. Adjust the door or put a spacer in between and then tighten the screws.

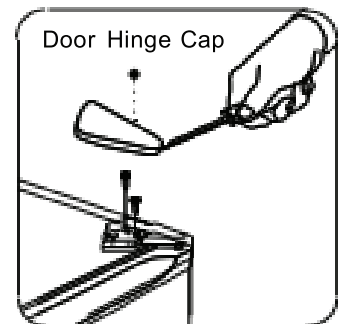

7. STARTING YOUR NEW RETRO MINI FRIDGE

After cleaning you Retro mini fridge thoroughly, wipe the outside with a soft dry cloth, and the interior with a clean moist cloth.

1. Insert the power supply.
2. Turn the thermostat dial to an initial setting of "7" for 15-20 minutes.

Note: As the door gets pressed in during shipping, the gasket may have to be reset. This is done to prevent the cool refrigerated air from escaping. If there is a space between the door gasket and the cabinet, set the gasket by gently pulling it out of the seal gap.

8. OPERATION

8.1 First use

- Before the use of the refrigerator, remove all the packages, including bottom cushion and foam pads and rubber belts in the refrigerator.
- Adjust the feet and clear the outside and inside of the refrigerator with warm cloth.
- Do not start the refrigerator immediately after vertical placement. Only start it after 2-6 hours standing to ensure its proper operation.
- To prevent damage to the power cord and any consequence incidents, the power cord should be not covered by the refrigerator or other objects. Before switching on the refrigerator, please check the voltage range of refrigerator carefully if the same as that of the power supply.
- When the refrigerator is first installed, allow it stabilize at normal operating temperatures for 2-3 hours prior to filling it with fresh or frozen foods.
- If operation is interrupted, wait for 5 minutes before restarting.

8.2 Temperature control

- The settings of the temperature control are "0, 1, 2, 3, 4, 5, 6, 7." Adjust the temperature to the settings that best suits your needs. The setting of "3" should be appropriate for home or office use.
- Adjusting the temperature to "0" position will turn off the cooling cycle but not the electrical power of the unit.

Note:

- The temperature will impact the storage time of food. Set the temperature as necessary.
- Wait 3-5 minutes before restarting if you unplug the refrigerator. The unit may fail to operate properly if restarted too quickly.
- If ambient temperature is too high, the refrigerator may not reach the desired target temperature.
- Large amount of food will lower the cooling efficiency of the appliance.
- Do not place the foods on the air outlet. Leave space for airflow.
- If you choose to change the thermostat setting, adjust the thermostat control once increment at a time. Allow several hours for temperature to stabilise between adjustments.

9. STORAGE OF FOOD

- Your appliance has the accessories as the "Structure illustration" showed in general, with this part instruction you can have the right way to storage your food.

Note:

Food is not allowed to touch directly all surfaces inside the appliance. It has to be wrapped separately in aluminum sheet or in cellophane sheet or in airtight plastic boxes.

Storing food in the refrigerator compartment

The fridge freezer compartment helps to extend the storage times of fresh perishable foods.

Fresh food care for best results:

- Store foods that are very fresh and of good quality.
- Ensure that food is well wrapped or covered before it is stored. This will prevent food from dehydrating, deteriorating in colour or losing taste and will help maintain freshness. It will also prevent odour transfer.
- Vegetables and fruit need not be wrapped if they are stored in the vegetable container of the fridge compartment.
- Make sure that strong smelling foods are wrapped or covered and stored away from foods such as butter, milk and cream which can be tainted by strong odours.
- Cool hot foods down before placing them in the fridge compartment.

Never forget:

- When you freeze fresh foods with a 'use by /best before/best by/' date, you must freeze them before this date expires.
- Check that the food was not already frozen. Indeed, frozen food that has thawed completely must not be re-frozen.
- Once defrosted, food should be consumed quickly.

Precooked foods and leftovers

- These should be stored in suitable covered containers so that the food will not dry out.
- Keep for only 1-2 days.
- Reheat leftovers only once and until steaming hot.

TYPE OF MEAT	STORAGE TIME
Chicken	1-2 days
Ground beef	1-2 days
Cold cuts	3-5 days
Steak/ Roast	3-5 days
Smoked/ Cured/ Meats	7-10 days
All others	1-2 days

The following foods are suitable for freezing:

Cakes and pastries, fish and seafood, meat, game, poultry, vegetables, fruit, herbs, eggs without shells, dairy products such as cheese and butter, ready meals and leftovers such as soups, stews, cooked meat and fish, potato dishes, soufflés and desserts.

The following foods are NOT suitable for freezing:

Types of vegetables, which are usually consumed raw, such as lettuce or radishes, eggs in shells, grapes, whole apples, pears and peaches, hard-boiled eggs, yoghurt, soured milk, sour cream, and mayonnaise.

10. DEFROSTING

- When you freeze fresh foods with a 'use by /best before /best by/' date, you must freeze them before this date expires. Check that the food was not already frozen. Indeed, frozen food that has thawed completely must not be re-frozen. Once defrosted, food should be consumed quickly.

Refrigerator compartment defrosts fully automatically

- While the refrigerating unit is running, beads of condensation or hoarfrost form at the back of the refrigerator compartment. This is normal. It is not necessary to wipe off the condensation or frost.
- The rear panel defrosts automatically. The condensation runs into the condensation channel and is conveyed to the refrigerating unit where it evaporates.

Note:

Keep the condensation channel and drainage hole clean, so that the condensation can run out.

Defrosting the freezer compartment

The freezer compartment does not defrost automatically, otherwise the frozen food would start thawing. A layer of frost in the freezer compartment impairs refrigeration of the frozen food and increases power consumption. Remove the layer of hoarfrost regularly.

WARNING: Do not scrape off hoarfrost or ice with a knife or pointed object. Doing this may damage the refrigerant tubes.

1. Remove the frozen food and place temporarily in a cool location.
2. Set the temperature control knob to the "o" position and disconnect the mains plug from the mains socket.
3. To accelerate the defrosting process, place a pan of hot water on a stand in the freezer compartment.
4. Wipe up condensation with a cloth or sponge.
5. Wipe dry the freezer compartment.
6. Plug in the appliance and adjust the temperature control knob as desired.
7. Put the frozen food back in the freezer compartment.

11. HELPFUL HINTS AND TIPS

We recommend that you follow the tips below to save energy.

- Try to avoid keeping the door open for long periods in order to conserve energy.
- Ensure the appliance is away from any sources of heat (Direct sunlight, electric oven or cooker etc)
- Don't set the temperature colder than necessary.
- Don't store warm food or evaporating liquid in the appliance.
- Place the appliance in a well ventilated, humidity free room. Please refer to Installing your new appliance chapter.
- The "STRUCTURE ILLUSTRATION" shows the correct combination for the drawers, crisper and shelves, do not adjust the combination as this is designed to be the most energy efficient configuration.

Hints for fresh food refrigeration

- Do not place hot food directly into the refrigerator or freezer, the internal temperature will increase resulting in the compressor having to work harder and will consume more energy.
- Do cover or wrap the food, particularly if it has a strong flavor.
- Place food properly so that air can circulate freely around it.

Hints for freezing

- When first starting-up or after a period out of use, let the appliance run at least 2 hours on the higher settings before putting food in the compartment.
- Prepare food in small portions to enable it to be rapidly and completely frozen and to make it possible to subsequently thaw only the quantity required.
- Wrap up the food in aluminum foil or polyethylene food wraps which are airtight.
- Do not allow fresh, unfrozen food to touch the food which is already frozen to avoid temperature rise of the latter.
- Iced products, if consumed immediately after removal from the freezer compartment, will probably cause frost burns to the skin.
- It is recommended to label and date each frozen package in order to keep track of the storage time.

Hints for refrigerator

- Meat (All Types) Wrap in polythene food: wrap and place on the glass shelf above the vegetable drawer. Always follow food storage times and use by dates suggested by manufacturers.
- Cooked food, cold dishes, etc.: They should be covered and may be placed on any shelf.
- Fruit and vegetables: They should be stored in the special drawer provided.
- Butter and cheese: Should be wrapped in airtight foil or plastic film wrap.
- Milk bottles: Should have a lid and be stored in the door racks.

Hints for the storage of frozen food

- Ensure that frozen food has been stored correctly by the food retailer
- Once defrosted, food will deteriorate rapidly and should not be re-frozen. Do not exceed the storage period indicated by the food manufacturer.

Switching off your appliance

- If the appliance needs to be switched off for an extended period, the following steps should be taken prevent mould on the appliance.
 1. Remove all food;
 2. Remove the power plug from the mains socket;
 3. Clean and dry the interior thoroughly;
 4. Ensure that all the doors are wedged open slightly to allow air to circulate.

12. CLEANING AND CARE

- For hygienic reasons the appliance (including exterior and interior accessories) should be cleaned regularly at least every two months.

WARNING:

The appliance must not be connected to the mains during cleaning. Danger of electrical shock!
Before cleaning switch the appliance off and remove the plug from the mains socket.

Exterior cleaning

- To maintain good appearance of your appliance, you should clean it regularly.
Wipe the digital panel and display panel with a clean, soft cloth.
- Spray water onto the cleaning cloth instead of spraying directly on the surface of the appliance.
- This helps ensure an even distribution of moisture to the surface.
- Clean the doors, handles and cabinet surfaces with a mild detergent and then wiped dry with a soft cloth.

Caution!

- Don't use sharp objects as they are likely to scratch the surface.
- Don't use Thinner, Car detergent, Clorox, ethereal oil, abrasive cleansers or organic solvent such as Benzene for cleaning. They may damage the surface of the appliance and may cause fire.

Interior cleaning

- You should clean the appliance interior regularly. It will be easier to clean when food stocks are low. Wipe the inside of the fridge freezer with a weak solution of bicarbonate of soda, and then rinse with warm water using a wrung-out sponge or cloth. Wipe completely dry before replacing the shelves and baskets. Thoroughly dry all surfaces and removable parts.

Caution!

- Don't use sharp objects to remove frost from the freezer. Only after the interior completely dry should the appliance be switched back on and plugged back into the mains socket.

Door Seal/ Gasket

- Take care to keep door seals clean. Sticky food and drinks can cause seals to stick to the cabinet and tear when you open the door. Wash seal with a mild detergent and warm water. Rinse and dry it thoroughly after cleaning.
- Petroleum jelly applied lightly on the hing side of the gasket will keep the gasket pliable and ensure a good seal.

Caution!

- Only after the door seals are completely dry should the appliance be powered on.

13. ENERGY SAVING TIPS

- The refrigerator should be located in the coolest area of the room, away from heat-producing appliances, heating ducts or direct sunlight.
- Let hot foods cool to room temperature before placing in the refrigerator. Overloading the refrigerator forces the compressor to run longer and thus increase energy consumption. Foods that refrigerate too slowly may lose quality or spoil.
- Be sure to wrap food properly and wipe containers dry before placing in the refrigerator.
- The shelves should not be lined with aluminum foil, wax paper or paper towels. It will interfere with cold air circulation, making the refrigerator less efficient.
- Organize food to reduce door openings and extended searches. Remove as many items as need at one time and close the door as soon as possible.

14. TROUBLESHOOTING

BEFORE YOU CALL FOR SERVICE

a) Check to make sure that the refrigerator is plugged securely. If not, remove the plug from the outlet and wait for 10seconds and plug it in again securely.

b) Check for a blown circuit fuse or a tripped main circuit breaker. If these seem to be operating properly, test the outlet with another appliance.

- If your device shows other symptoms other than those described below, please call the after sales service of the shop or retailer.

Symptom	Cause	Solution
The appliance does not work.	There is no power supply.	Check the plug connecting it others appliance, or verify that the appliance is connected to the plug.
	The appliance is not switch on.	Turn on the temperature control dial, it may be "0" or OFF.
	The fuse doesn't work.	Replace the fuse.
The appliance makes a lot of noise.	The appliance is too close to the wall, or is not stable, or the accessories inside the refrigerator are placed in wrong position.	Stabilize the base of the refrigerator by adjusting the position of feet, take away the device of the wall, place correctly the accessories inside the refrigerator.
The appliance doesn't cool enough.	The door is too often opened or was left opened for a long time.	Close the door and do not open it too much frequently.
	The refrigerator is too close to the wall.	Take away the device of the wall to favor the ventilation.
	The refrigerator is too full.	Remove food of the device.
	The temperature is badly adjusted.	Turn the knob of regulation of temperature on "3" or more

Symptom	Cause	Solution
The door does not shut properly	The door is not properly aligned	Re-align the door. Refer to "Door Alignment" section.
	Possible blockage from containers, shelves, bins, etc.	Make sure nothing is blocking the door.
There are smells in the appliance.	Food made obsolete inside the refrigerator.	Throw away obsolete food and wrap the other.
	The inside of the device at need to be cleaned.	Clean the inside of the refrigerator.

The following symptoms are not breakdowns:

- The noise of the cooling liquid which circulates in pipes can be heard, it is normal.
- The humidity on the surface outside of the device during the wet seasons is not a problem of the device; you just need to wipe it with a dry soft cloth.
- The compressor and the condenser can warm more during the periods of strong heat.
- The frame of the door is a bit hot; it means that the condenser works to evacuate the humidity of air.

15. ENVIRONMENTAL TIPS

Observe all safety and warning information during operation (see the "General Safety Instructions" section).

15.1 Disposal considerations

The transport and protective packaging has been selected from materials which are environmentally friendly for disposal, and can normally be recycled.

Recycling the packaging reduces the use of raw materials in the manufacturing process and also reduces the amount of waste in landfill sites. Ensure that any plastic wrappings, bags etc. are disposed of safely and kept out of the reach of babies and young children. Danger of suffocation.



15.2 Disposing of your old appliance

Electrical devices marked with this label may not be disposed of in domestic waste at the end of their service life.

Electrical and electronic appliances often contain valuable materials. They also contain specific materials, compounds and components, which were essential for their correct function and safety. These could be hazardous to human health and to the environment if disposed of with your domestic waste or if handled incorrectly. Please do not, therefore, dispose of your old appliance with your household waste.

Please dispose of those materials by contacting your local authorities and ask for the correct method of disposal. Please ensure that your old appliance poses no risk to children while being stored prior to disposal.

By disposing of this product in accordance with the regulations, you protect the environment and the health of those around you from negative consequences.

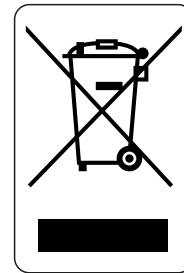

16. WARRANTY & AFTER SALES SERVICE

Observe all safety and warning information during operation (see the "General Safety Instructions" section).

In the event of a fault which you cannot remedy yourself, please contact Linärie.

16.1 Warranty

The manufacturer's warranty for this appliance is 2 years.

16.2 After sales service

The contact details for Linärie are given at the beginning and of these instructions.

When contacting Linärie, please quote the model and serial number of your appliance. These can be found on the data plate, after removing the grease filter.

Record model & serial number

Model:.....

Serial Number:.....

Register your product www.linarie.com.au

16.3 Replacement of spare parts

Incorrect components can lead to personal injury or damage to the appliance. Use only genuine original Linärie spare parts.



Modifications, additions or alterations to the appliance can lead to safety risks. If spare parts or accessories from other manufacturers are used, the warranty will be invalidated, and Linärie cannot accept liability.

Please check www.linarie.com.au for more information.

LIKE TO KNOW MORE?

For further information on all Linärie appliances,
or to obtain detailed dimension and installation
information, phone or email our Customer Care
team or visit our website:

Australia
hello@linarie.com.au
www.linarie.com.au

Follow Us
[@Linarie.Appliances](#)
  

Operating and installation instructions:

Original

√ Translation

Mart Online Services Pty Ltd.
ACN 657 824 050

Linärie Contact
hello@linarie.com.au
www.linarie.com.au

The distribution and duplication of this document, as well as the use and disclosure of its contents are prohibited unless expressly authorised.

These operating and installation instructions have been drawn up with the greatest of care. But it cannot be ruled out that subsequent technical modifications have not yet been incorporated or the relevant content has not yet been adapted. Please accept our apologies in this eventuality. An updated version can be requested from our team. Subject to printing errors and mistakes.

© Linärie

All rights reserved.