

How to tighten the screws

1. It is always recommended to tighten the screws deep enough. The tighter the screws are, the more stable a puzzle will be (and probably more stiff while making turns).

2. Always leave a little bit of radial space along the screw so that the center cap can be lifted by around 1~2mm for single layered models.

**For those in-between models, like #65, #85, #88, #89, it is recommended to tighten further.

**For neat multiple layered models like #61, #75, #87, tighten the screws to their full depth.

3. Rules of thumb. Tension adjustment is in general dependent on personal judgement. Different tension could result in very different feel. Start with simple models and accumulate your own sense. Use different springs, screws, nuts if you think the default set can't provide your favorite handle.

4. Previous description of sticking screws out of nuts by 1-3mm is misleading in some cases and is not anymore recommended. Reason: the height of caps varies in different models.

VeryPuzzle
2021/08/06

VeryPuzzle



IRT V1.0
IIRT1-M3

#81

600+ parts
50 axes



1

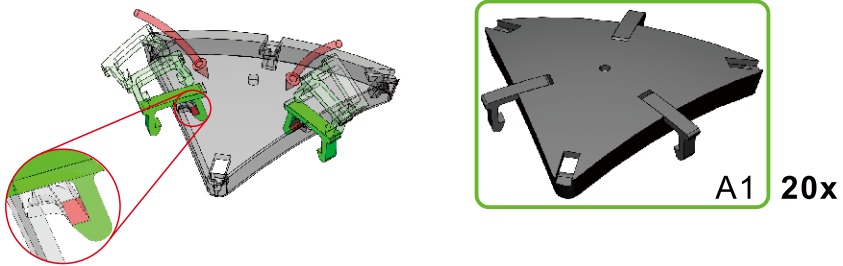
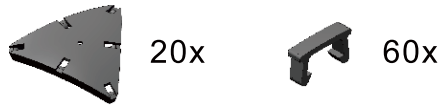

2

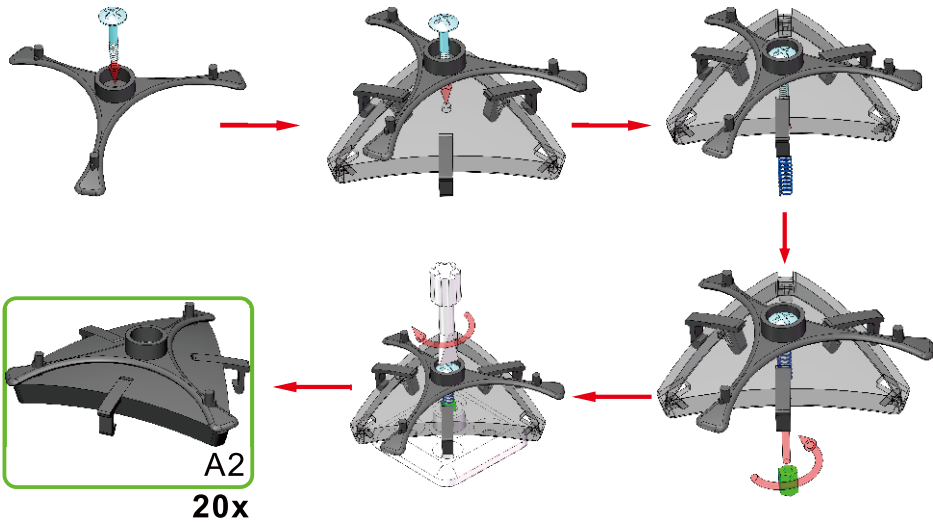

3

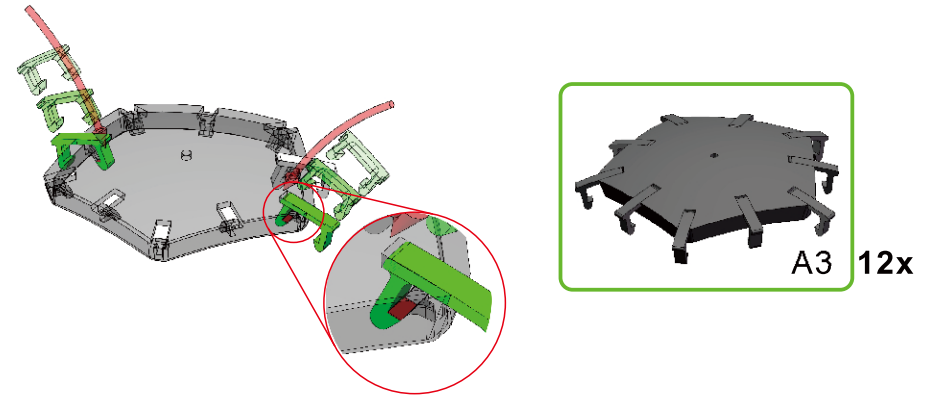
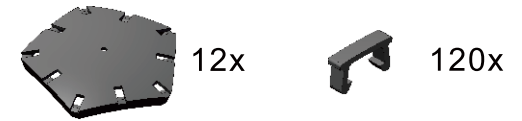

4

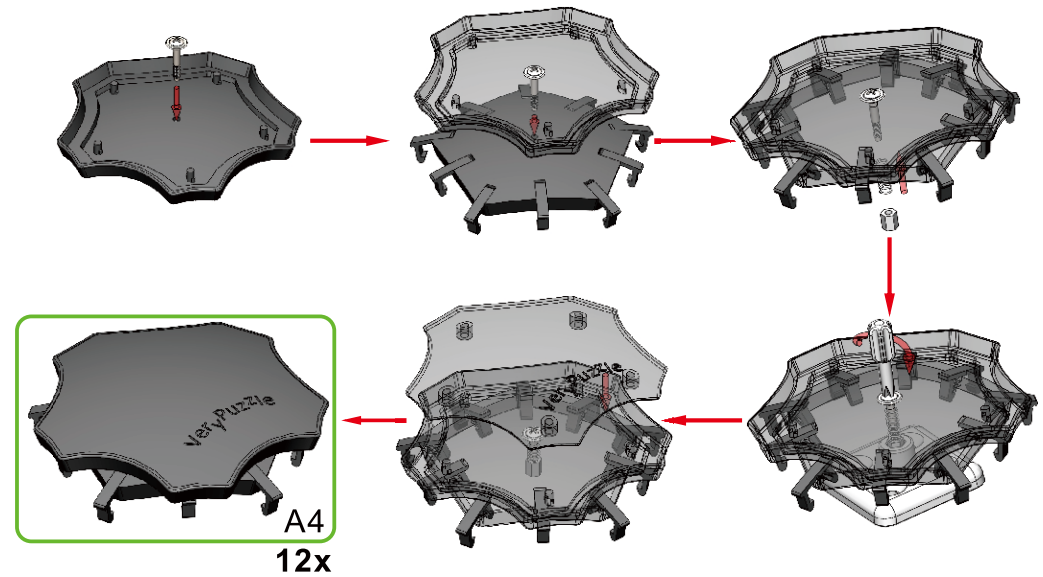
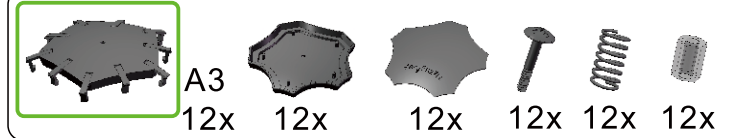

5

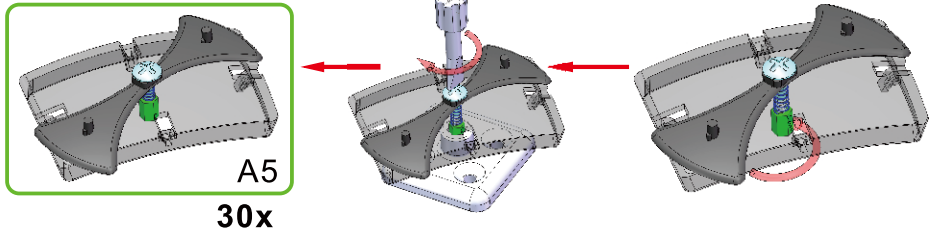
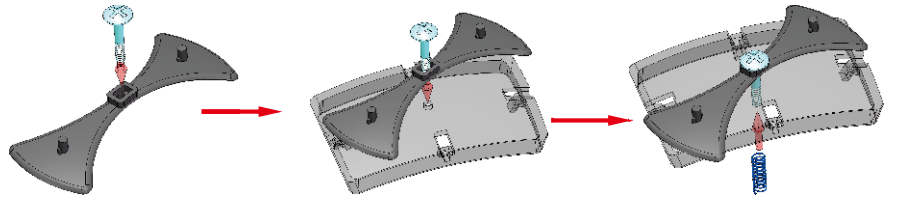

6

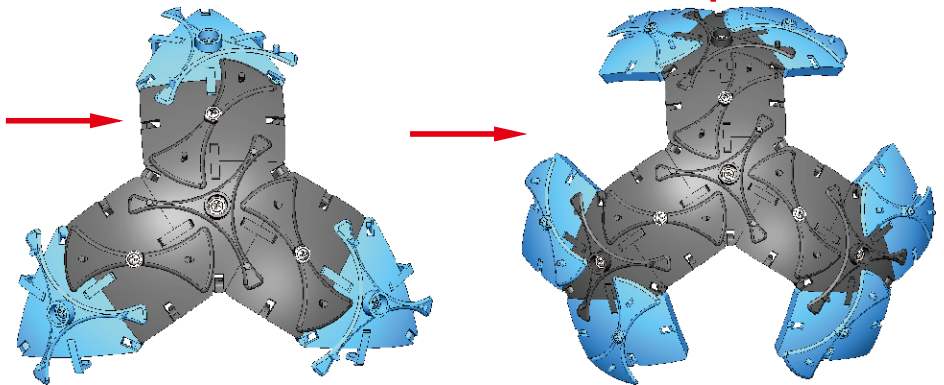
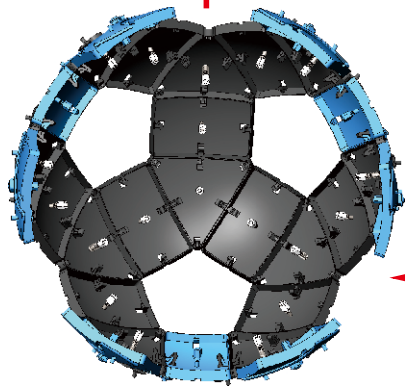
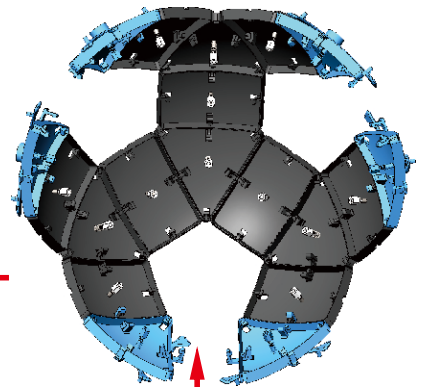
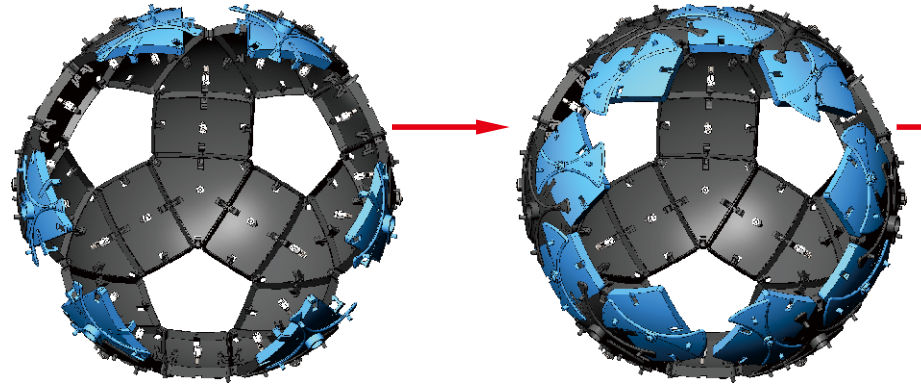
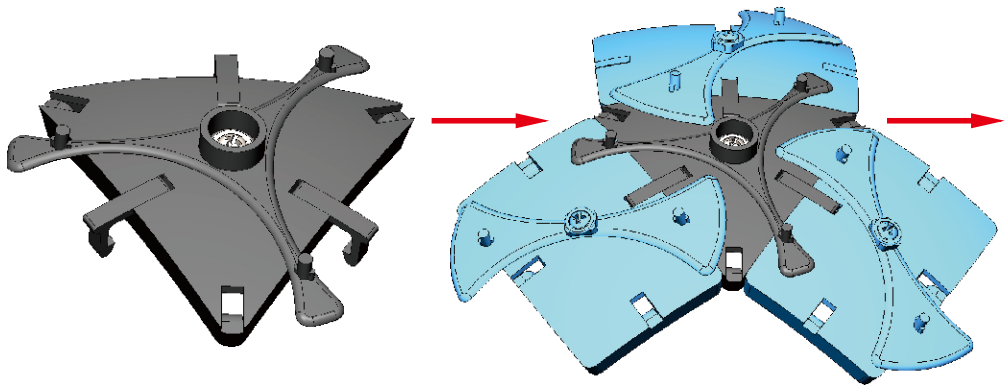

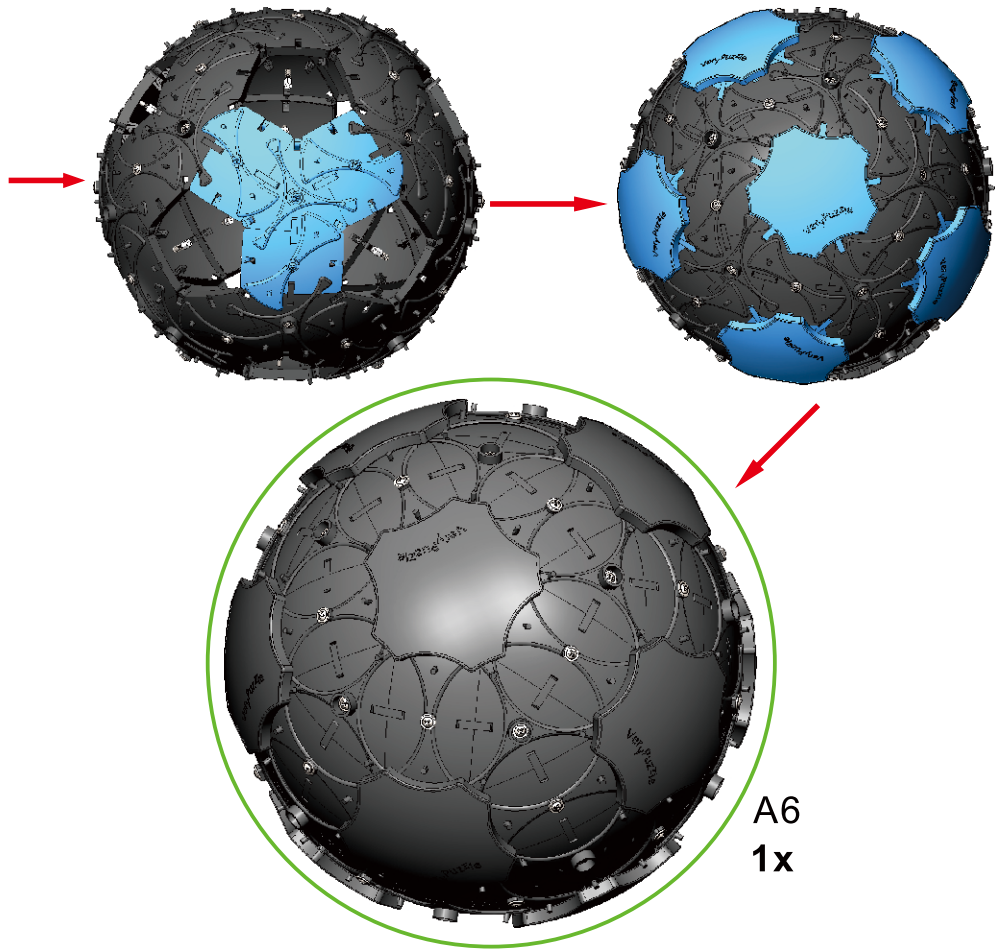

7

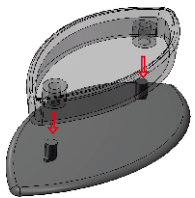
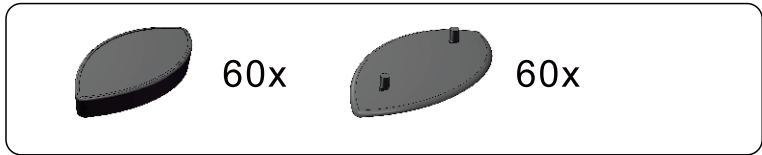

8

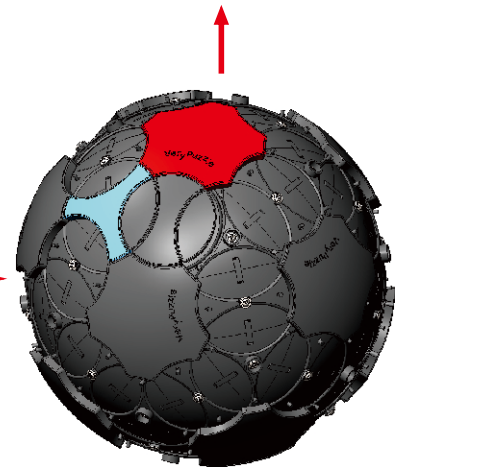
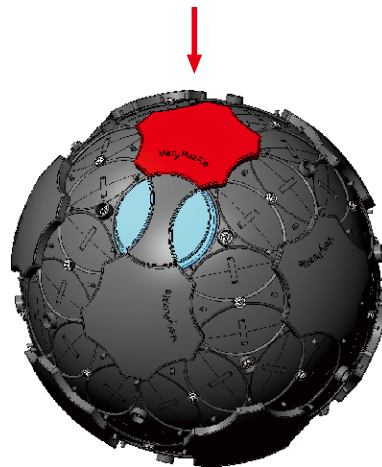
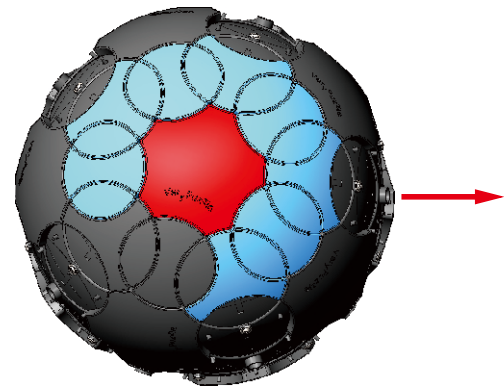
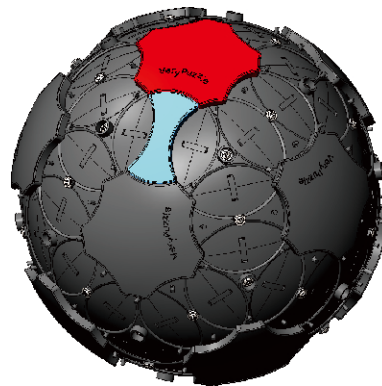
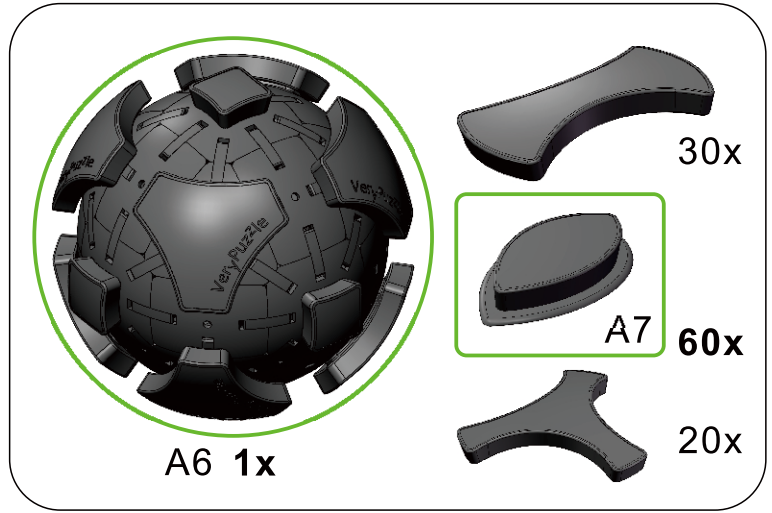

8

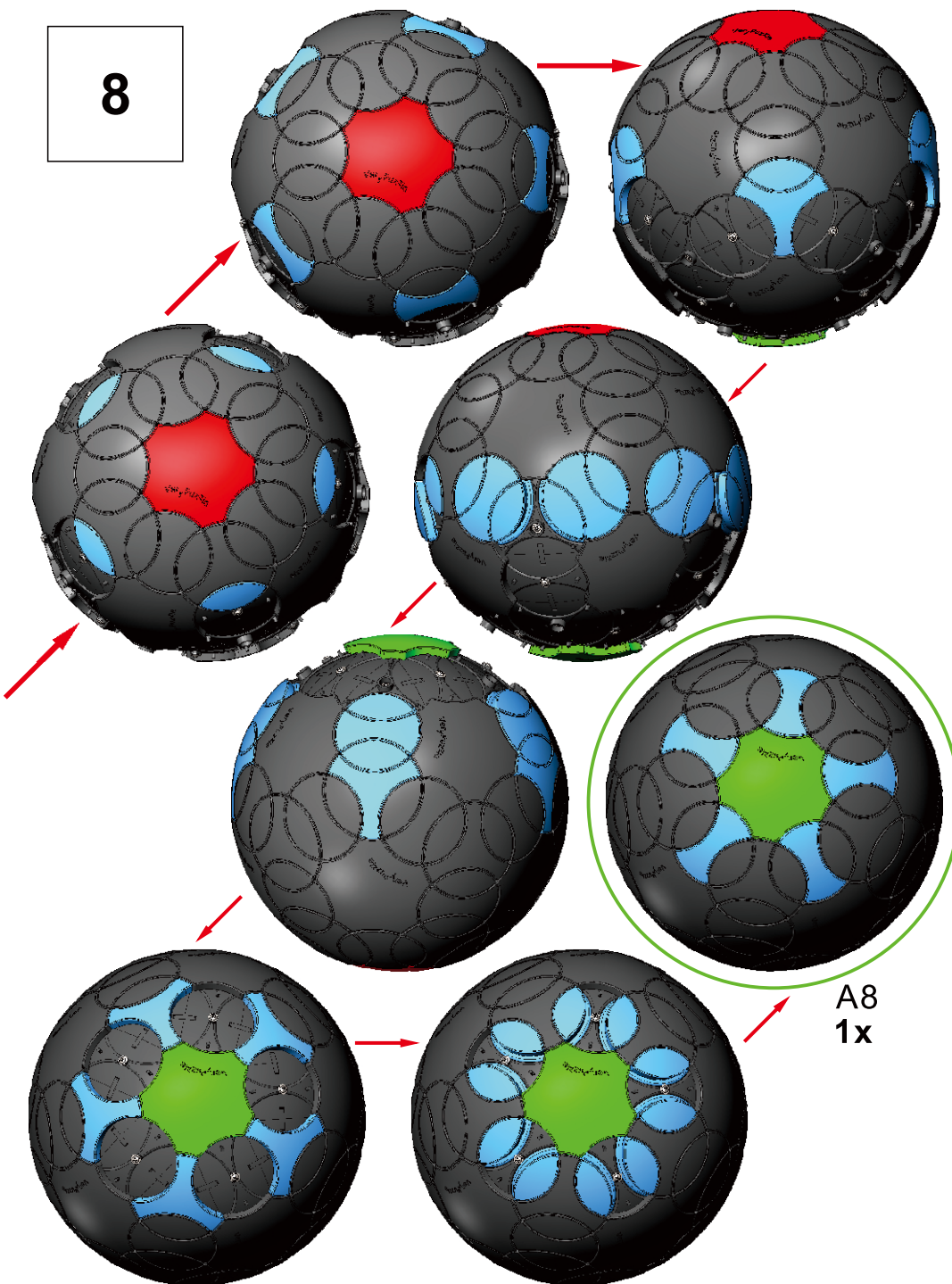

A8
1x

9

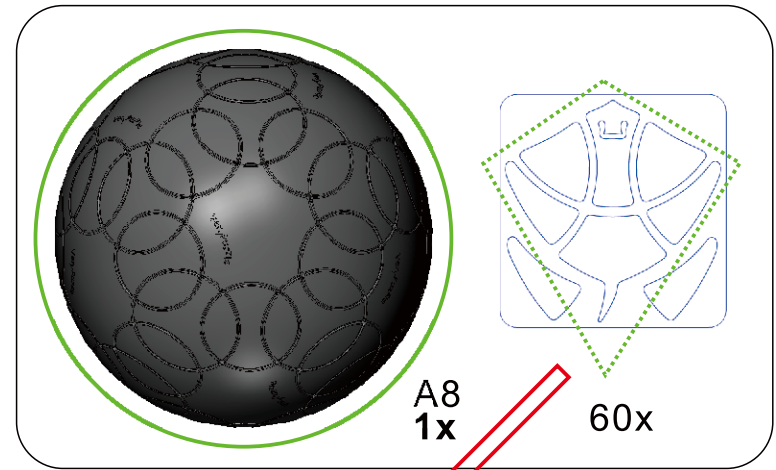

A8
1x

60x

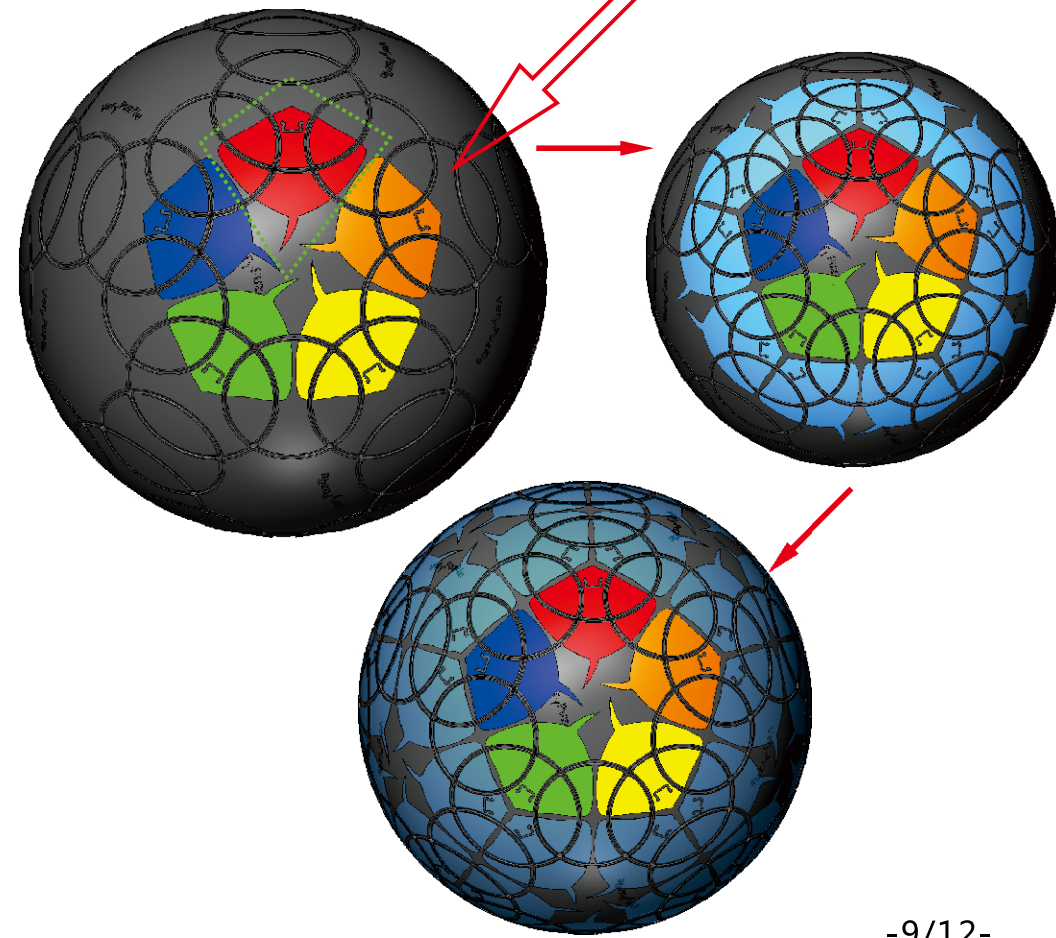

10

Rotation Rules



3-fold symmetry
Turns $120 \cdot n$ degrees



2-fold symmetry
Turns $180 \cdot n$ degrees

Notations and Algorithms

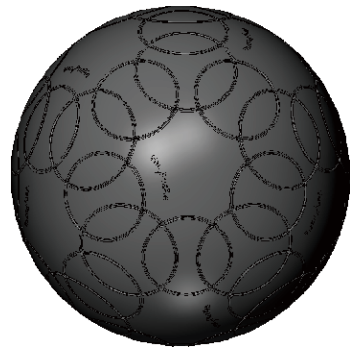
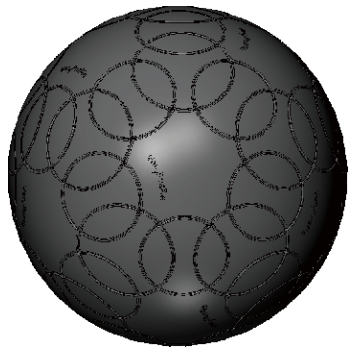

Product Information Card

Product Name	IRT V1.0 / I1RT1-M5
Model NO.	#81
Design	VeryPuzzle Co., Ltd(HK)
Manufacturer	VeryPuzzle Co., Ltd(HK)
Year of release	2020
Maximum diameter	195 mm
Visible moving parts	122 pcs
Assembly challenge	★★★★☆☆☆☆
Solving challenge	★★☆☆☆☆☆☆
Stickers strategy	Voronoi based artistic
Sticker material	Textured & uniform matt
Color scheme	60 colors
Sticker protection	Yes
Number of stickers	360 pcs
Axis & Symmetry	I(C3)+RT(C2)
In-core spring	Yes
Adjustable tension	No
Topological Print	I17RT15
Core specification	DIRT180

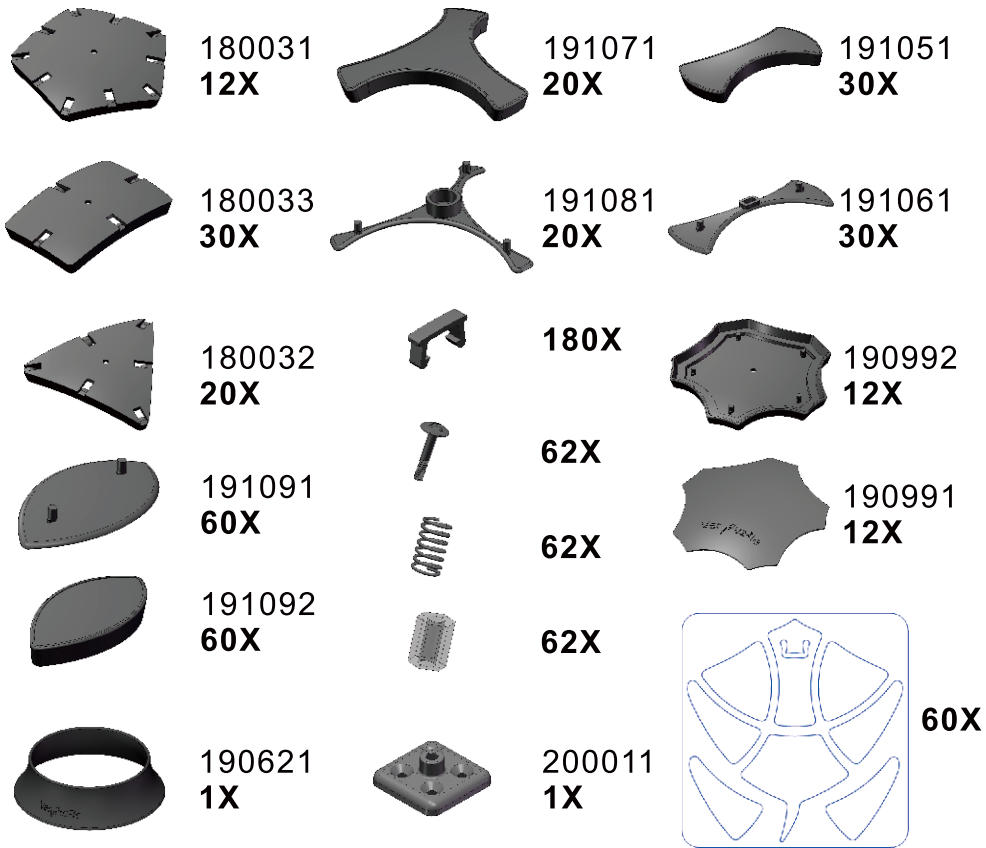

Customer Service

1. support@verypuzzle.com



VeryPuzzle