

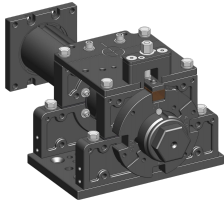

# UNIVERSAL SONAR MOUNT SHEAR BLOCK IDENTIFICATION GUIDE

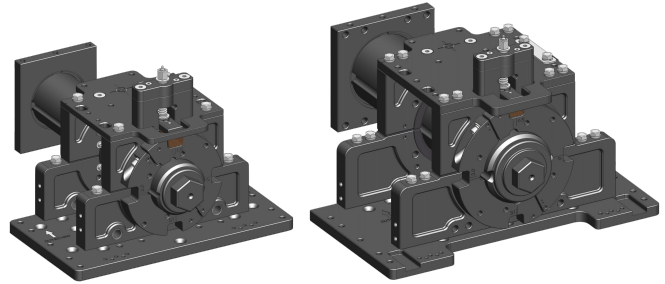

**COMPACT**



**HIGHTOWER & MEGATOWER**

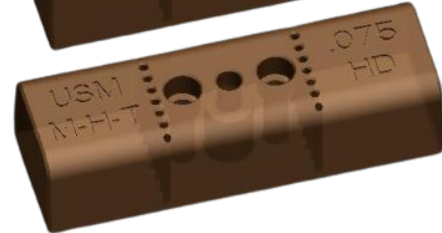
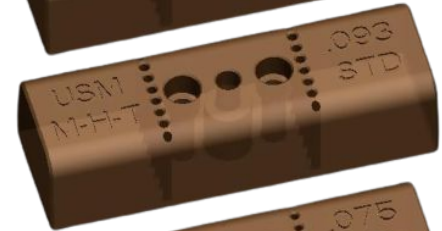
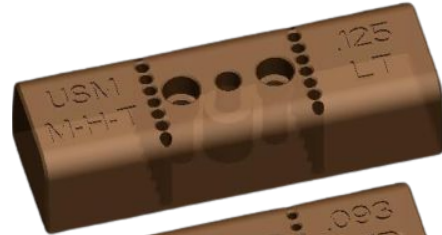
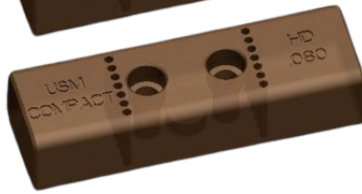
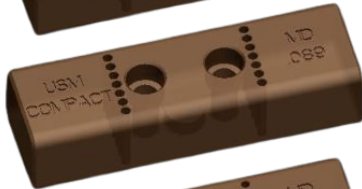
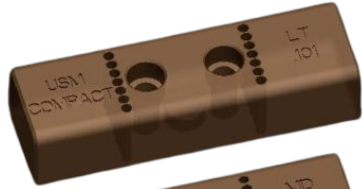

**STANDARD-LEGACY**

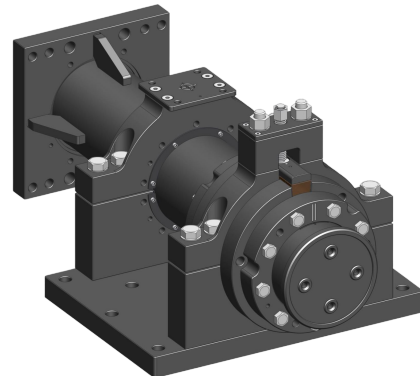

**XL MOUNT**

