

揽盛2一体充 Panoramic View 2 Tent 安装说明 Instruction manual

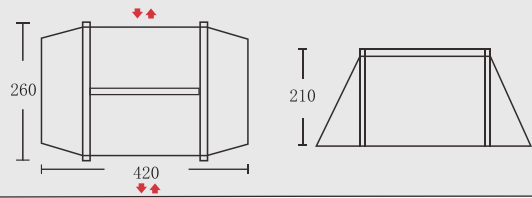

从外袋中取出帐篷, 地钉袋 (如上图), 选择背风、平整的地面, 防止有锐物划伤底部, 把帐篷平摊于地。
Take tent and pole bag out from carry bag, then choose the leeward and flat ground.

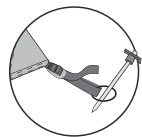
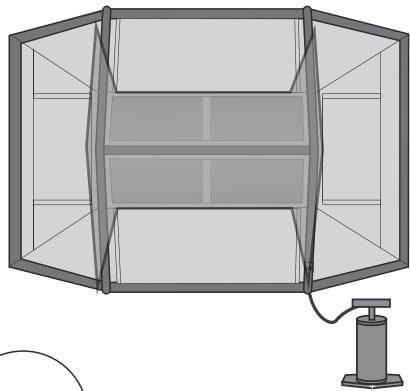

将帐篷摊平后, 前后角打上地钉
Spread out the tent and fix it with stakes.

1

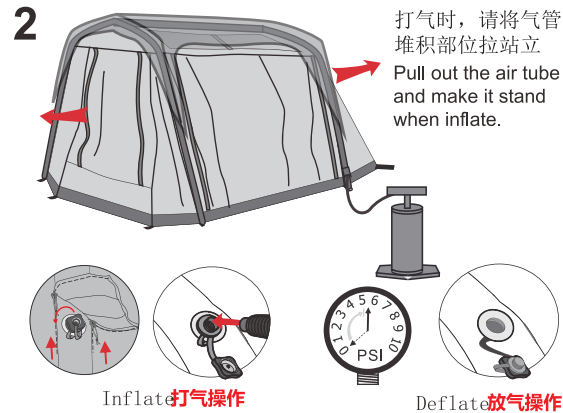

将充气口拉链打开后, 把气嘴盖旋转后打开, 将打气筒插入后开始进行打气。
注: 放气时, 请将气嘴拧开排气。
Open the zipper of PVC tube cover and open the mouth, then connect the air pump to inflate.
Remark: open the mouth to deflate.

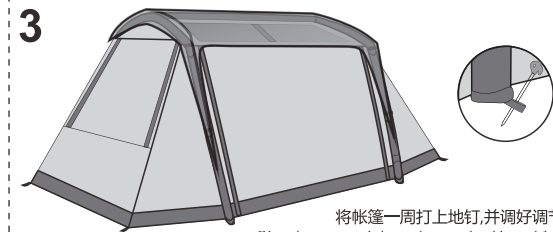

手动打气时: 感受到打气筒打气吃力; 带气压表工具打气时: 打气至5.5PSI, 以上2种方式打气时, 气管拍起来有清脆有力, 即可停止打气。
Stop inflating when you use the pump without barometer and feel inflate hardly.
Stop inflating when you use the pump with barometer and see the barometer shows 5.5PSI.
当气温高达37℃时和当春夏露营太阳暴晒帐篷时
高温会使气压上升40%, 需要适当放气出来。
You need to deflate some air appropriately when you use the tent in the temperature of 37℃ or spring/summer time. The high temperature will rise the pressure by 40%.

养护说明

- 每次出行后将内外帐及帐杆、地钉清理干净, 主要清理对象为雪、雨、尘灰、泥草以及小虫子。
- 帐篷不可使用洗衣机清洗, 可用水冲, 手搓等洗涤方法, 使用非碱性清洗剂, 清洗后放置通风处阴干, 拆好装进收纳袋存放在干燥、阴凉的地方, 帐篷要不规律折叠, 因为多次使用帐篷后, 折叠太规律整齐会使折痕硬化出现裂痕。
- 使用帐篷时注意不可穿鞋进入内帐, 因为鞋底连带的泥土、石子等极易其容易将内帐底部划破, 从而失去防水意义。
- 避免在帐篷内炊事、吸烟、高温及明火对帐篷的危害很大, 如果外部天气恶劣必须在帐内炊事, 则需在炉头下垫上铝膜或其他隔热物品, 并将帐篷的所有门窗打开。
- 夜间帐内照明尽量避免使用蜡烛等无保护措施明火物品做为照明道具, 尽量使用头灯, 手电及帐篷专用汽灯。
- 出现破洞, 拉链及支架破损可以联系经销商或者联系厂家。

顶棚取下后将顶棚拉攀上的登山扣取下后钩在帐篷上织带别处

注: 收到货时顶棚固定在帐篷上。
顶棚可拆卸使用。

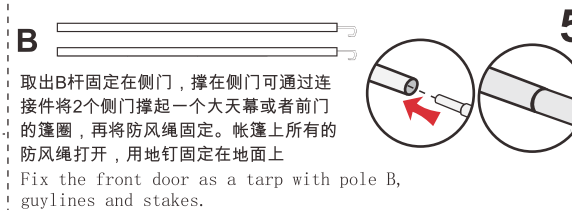

综合配件 Accessories

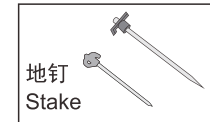
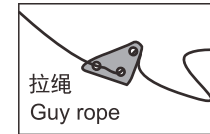
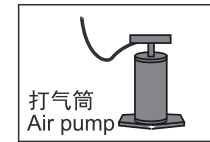

若有质量问题, 请立即与销售商联系。
售后咨询电话: 400 066 2858
依据ISO5912
Aftersales service:
0086-4000662858