

# ROLLERS TOILES



## INSTALL GUIDE D'INSTAL LATION



**Difficulty**  
Difficulté



**Required tool**  
Outils requis

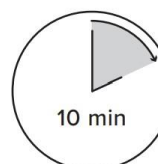

**Time**  
Temps requis

# ROLLERS TOILES

**Open roll**  
**Rouleau exposé**

## Parts inventory Inventaire des pièces

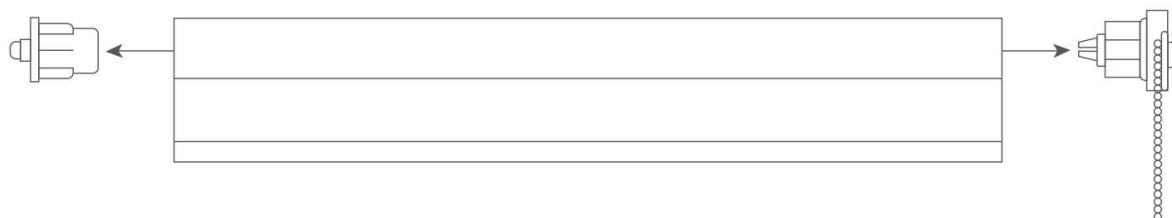
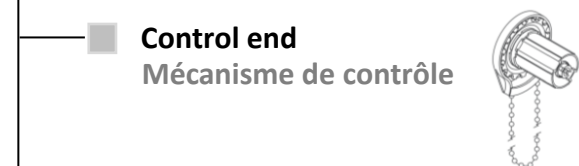

# ROLLERS TOILES

## Open roll Rouleau exposé

# 1

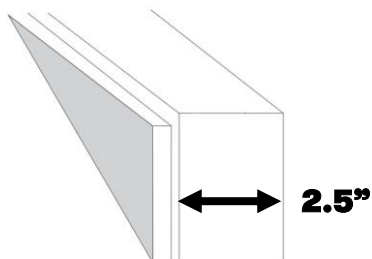

Verify your window depth before putting up your support brackets to assure no obstructions are in the way such as handles and door knobs.

Évaluer la profondeur pour dégager les obstacles avant de choisir l'emplacement du support. Dans le cas d'une fenêtre à manivelle, prévoir une installation pour la dégager.

# 2

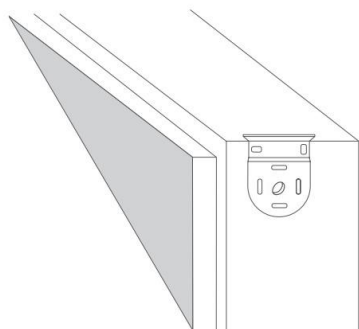

Inside mount  
Pose intérieur

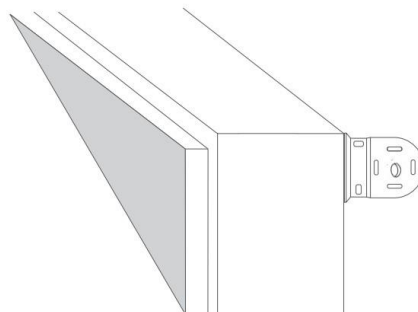

Outside mount  
Pose murale

Mark the position of both brackets before drilling. Make sure they are aligned. Position bracket so that the blind can be raised and lowered freely. Drill the support brackets (2 screws per bracket) into the frame.

Marquer la position des deux support avant de percer. Assurez-vous qu'ils sont alignés. Positionner les supports afin que le store puisse monter et descendre librement. Installer les supports (2 vis par support) dans le cadre.

# ROLLERS TOILES

**Open roll**  
**Rouleau exposé**

**3**

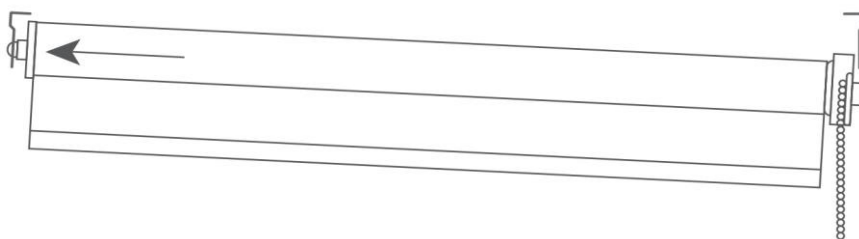

**Place the idle end into the round hole of the bracket.**

Placez l'embout d'extrémité dans le trou rond du support

**4**

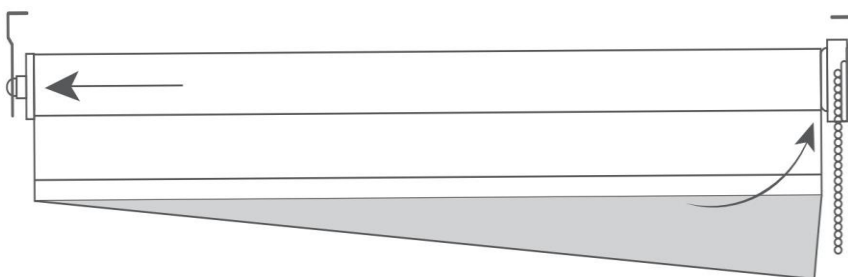

**While pushing the idle end towards the bracket, slide the control side up into the other support bracket.**

Tout en poussant l'embout de l'extrémité contre le support, monter l'autre côté niveau et accrocher le mécanisme de contrôle au support

**The control side hooks should point downwards**

Les crochets du côté du mécanisme doivent pointer vers le bas

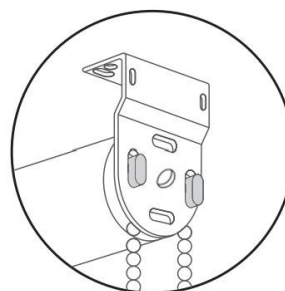

# ROLLERS TOILES

**Open roll**  
**Rouleau exposé**

**5**

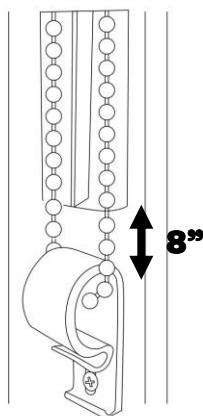

**Screw the P clip to a wall near the blind to keep the chain tight. Use the exposed chain to operate your shade.**

Visser le clip de sécurité sur le mur près du store. Maintenez la chaîne tendue. Utilisez la partie exposée de la chaîne pour faire fonctionner votre store