

CAMPLUX

INSTANTANEOUS ELECTRIC WATER HEATER

Instruction For Installation And Use



Model: TE06Pro & TE06BPro

Optional Colour

White

Black



1



Please read and follow the installation and operation instructions carefully, to ensure the long life and reliable operation of this appliance.

Contents

Safety Instructions02-04

Symbols Used in This Manual 02

Mounting Instructions 05

User Manual 06-07

Troubleshooting by Users 08-09







Safety Instructions

Congratulations and thank you for choosing our instant water heater. The instruction contains important information about commissioning, switching the device on and maintenance. To ensure your safety and that of others we recommend you read through this safety manual carefully. Please refer to the back of the manual for details about the warranty. Keep this manual for future reference.

If you lose the manual, contact your local distributor or manufacturer. When you call, please tell us the model number and the serial number of your unit written on the rating plate of the water heater.

Symbols Used in This Manual

The following symbols are used in this manual and on the appliance:

	Failure to observe this instruction may expose you or others to danger. Failure to observe this instruction may lead to damage to the device.
	Indicates live parts. Failure to observe this instruction may lead to damage to the device or danger to you or others.
	Please read the manual.
	Hazardous materials and waste electrical and electronic equipment should be taken to a designated recycling point.

Important safety instructions

When using this electrical equipment, basic safety precautions should always be followed, including the following.



Read and follow all instructions

All supply circuits must be disconnected before removing cover. Supply this appliance only from a grounded system. A wire connector marked "⊕" is provided for wiring the appliance. Connect the connector to the grounding terminal of the electric service or supply panel with a continuous copper wire in accordance Canadian Electrical Code, Part I.

This product shall be protected by a Class A ground fault circuit interrupter.

This appliance is not intended for use by persons (including children) with reduced physical, sensory or mental capabilities, or lack of experience and knowledge, unless they have been given supervision or instruction concerning use of the appliance by a person responsible for their safety.

Children should be supervised to ensure that they do not play with the appliance.

The maximum inlet water pressure: 1.0 MPa (150 PSI).

The minimum inlet water flow: 0.26GPM

Warning

Before obtaining access to terminals, all supply circuits must be disconnected. After service work is complete, proceed as during the firsttime appliance start-up.

 The connection diagram or wiring diagram is marked. (Located on inside of Front Enclosure)

Caution

1. DO NOT INSTALL IN A BATH ENCLOSURE OR SHOWER STALL OR CONNECT TO A SALT- REGENERATED WATER SOFTENER OR A WATER SUPPLY OF SALT WATER.
2. CONNECT ONLY TO A CIRCUIT PROTECTED BY A CLASS GROUND FAULT CIRCUIT INTERRUPTER.

 For use on an individual branch circuit only.



Use copper conductors only

USE BONDING CONDUCTOR IN ACCORDANCE WITH THE CANADIAN ELECTRICAL CODE, PART I.

Each individual heating element is marked with the manufacturers' part number or its electrical rating in voltage and amperes/watts.

The specific spacing between the appliance and adjacent surface.

Save these instructions

The appliance is not to be installed in locations where freezing can occur.

 The resistivity of the water supply must not be less than 3300 $\Omega \cdot \text{in}$.

 The appliance must be grounded properly!

 The appliance is close-outlet type, the water connection of this appliance must be connected to unvented water heating system.

 No changes may be made to the appliance.

If the supply cord is damaged, it must be replaced by the manufacturer, its service agent or similarly qualified persons in order to avoid a hazard.

Standards and regulations

The installation (plumbing and electrical work), commissioning and maintenance of this appliance should only be undertaken by personnel with electrical

engineering qualifications and in accordance with the relevant standards and regulations (BSI, etc.) and this manual.

The following should also be observed:

- The appliance name plate;
- The technical specifications.

Connection to the water supply

Compatible cold water pipe materials: steel, copper and plastic.



Mounting Instructions

Electrical installation

The appliance must be permanently connected to fixed wiring.

The device has been prepared for connection to the electrical supply. These units require a 240V, single-phase supply. Please take reference of the rating plate on device.

Please take reference of the following diagram to connect power supply with Elex series.

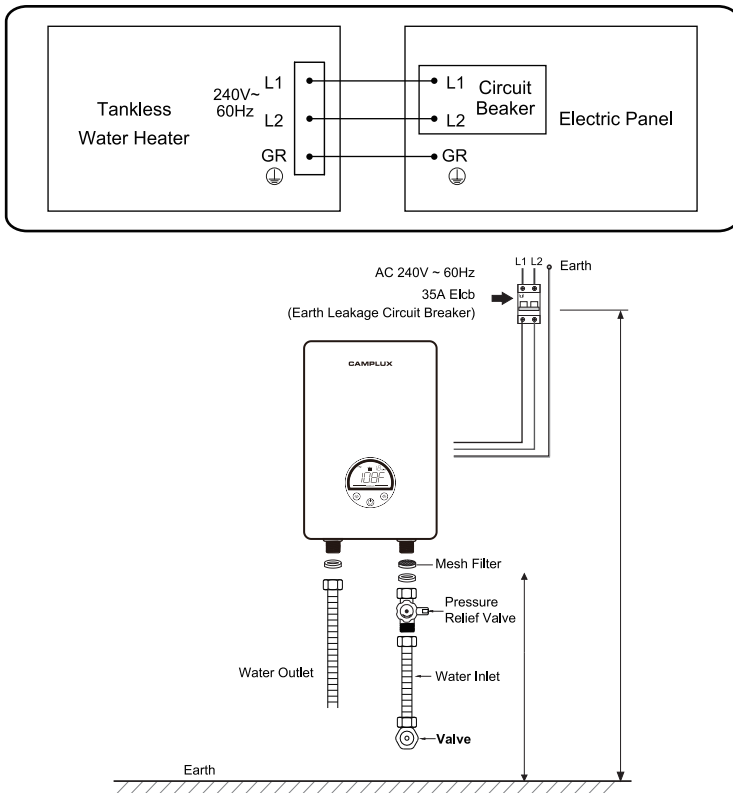

This cable can be surfaced clipped, hidden or via 20mm conduit.





User Manual

Operation

The installation (plumbing and electrical work), commissioning and maintenance of this appliance should only be undertaken by personnel with electrical engineering qualifications and in accordance with the relevant standards and regulations (BSI, etc.) and this manual.

The electronically regulated continuous-flow water heater with automatic temperature adjustment keeps the outflow temperature constant.

The device has touch key to switch it on and off, and  /  keys to adjust the heating.

 : Decrease the outlet setting temperature;

 : Increase the outlet setting temperature.

Adjust the temperature settings as desired.

If the selected outflow temperature is not reached when the tap is fully opened, then the water flow through the device exceeds the capacity of the device. In this case, the flow should be reduced with the hot water valve. There is a danger of scalding at outflow temperatures exceeding 108°F.

 This unit is intended for use with shower heads with a low pressure Loss. Mixer taps and thermostatic mixer taps should be of a design compatible with devices with flow control.

 Fittings for open-outlet water heaters should not be used!
Only fittings for close-outlet water heaters can be used!

Suggestion: To ensure that the minimum flow (switch-on flow 0.26 GPM) of a water-pressure operated device is reached.



 Without a temperature limiter, high temperatures may be reached at draw-off points. Keep children away from the draw-off points. Danger of scalding!

 The appliance should be disconnected from the electrical mains supply when working on the water supply. After service work is complete, proceed as during the first-time appliance start-up.

 The main water valve should be closed before any work is done on the water pipe.

 If the water supply is interrupted, e.g. due to maintenance on the mains water supply, then the following steps should be undertaken before returning the device to operation:

1. Remove the fuses or isolate the device in another way.
2. Open a hot water valve connected to the device until the air is vented from both the device and the cold-water supply pipe.
3. Reconnect the supply.

First aid

- Check the leakage protection switch and the fuses.
- Check if any fittings or shower head are affected by the build-up of lime scale or dirt.
- See also "Troubleshooting by users".



Troubleshooting by Users

Problems	Cause	Solution
Water heater is not heating at all (water is flowing but the Unit is not heating - the outgoing water temperature is the same as the cold water supply) - the digital display does NOT light up.	No power or incorrect wiring.	Make sure the breakers at main electrical panel are ON. You may have a faulty breaker or unit may be wired incorrectly.
Water heater is not heating at all (water is flowing but the unit is not heating - the outgoing water temperature is the same as the cold-water supply) The digital display DOES light up, but no temperature display.	Flow rate is too low / water pressure is too low.	Your water heater has an activation flow rate of approximately 0.26GPM. If your water flow rate is less than this level, your unit will not activate. Increase the flow rate or check the filter mat inside the inlet connector.
	The air bubbles in the water heater have not been purged out.	Make sure the breakers at main electrical panel are ON, turn on the unit and open the hot water tap for about 20s.
Flow rate is too low.	Something was blocked in the filter mat / Pipe was blocked.	Check and clean the filter mat inside the inlet connector.

Display "E1"	It means the product is overheated	Lower the setting temperature or replace the temperature measurer
Display "E2"	It means there is leakage of electricity	Contact with the maintenance department
Display "E3"	It means the inlet temperature measurer is broken	Replace the temperature measurer
Display "E4"	It means the outlet temperature measurer is broken	Replace the temperature measurer



Problems	Cause	Solution
<p>Water heater is heating, but the water temperature is not hot enough.</p>	<p>User temperature setting too low.</p>	<p>Increase the temperature setting on the unit.</p>
	<p>Flow rate is too high / water pressure is too high.</p>	<p>Depending on your incoming water temperature and the kW of your heater, your water flow rate may exceed the physical heating capacity of your water heater. Reduce the flow rate by installing a Flow Regulator.</p>
	<p>Crossed wires.</p>	<p>If it's a new installation, have your electrician double check the wiring. Is possible that the wiring is incorrect.</p>
	<p>Voltage less than 240 volts.</p>	<p>The heating elements on your water heater are design for 240 volts. When used with a lower voltage, they produce less heating power. You may need to upgrade to a larger input heater.</p>
	<p>Mixing too much cold water.</p>	<p>You do not need to mix as much cold water with your tankless water heater compared to when you use a conventional water heater. You may also have an antiscaid feature on your faucet that is mixing cold water. These types of faucets can usually be adjusted to reduce the amount of cold water mixed.</p>



CAMPLUX



8350 Patriot Blvd STE B, North Charleston, SC 29420

1(844) 538-7475

support@camplux.com

Visit Us: [Camplux.com](https://www.camplux.com)

CAMPLUX

