



## **Electric Induction Cooktop Instruction For Installation And Use**

**Model No. : IH12BF**

**IH30BF**

**IH60BF**

**IH77BF**

**IH90BF**

Important! Read these instructions for installation and use carefully. Keep these instructions for future reference. Any questions regarding the operation, maintenance service or warranty of the appliance should be directed to GASLAND Chef.



## 01 Safety Warning

Your safety is important to us. Please read this information before using your cooktop.

### Installation Electrical Shock Hazard

- Disconnect the appliance from the mains electricity supply before carrying out any work or maintenance on it.
- Connection to a good earth wiring system is essential and mandatory.
- Alterations to the domestic wiring system must only be made by a qualified electrician.
- Failure to follow this advice may result in electrical shock or death.

### Cut Hazard

- Take care - panel edges are sharp.
- Failure to use caution could result in injury or cuts.

### Important Safety Instructions

- Read these instructions carefully before installing or using this appliance.
- No combustible material or products should be placed on this appliance at any time.
- Please make this information available to the person responsible for installing the appliance as it could reduce your installation costs.
- In order to avoid a hazard, this appliance must be installed according to these instructions for installation.
- This appliance is to be properly installed and earthed only by a suitably qualified person.
- This appliance should be connected to a circuit which incorporates an isolating switch providing full disconnection from the power supply.
- Failure to install the appliance correctly could invalidate any warranty or liability claims.



## Operation And Maintenance Electrical Shock Hazard

- Do not cook on a broken or cracked cooktop. If the cooktop surface should break or crack, switch the appliance off immediately at the mains power supply (wall switch) and contact a qualified technician.
- Switch the cooktop off at the wall before cleaning or maintenance.
- Failure to follow this advice may result in electrical shock or death.

## Health Hazard

- This appliance complies with electromagnetic safety standards.
- However, persons with cardiac pacemakers or other electrical implants (such as insulin pumps) must consult with their doctor or implant manufacturer before using this appliance to make sure that their implants will not be affected by the electromagnetic field.
- Failure to follow this advice may result in death.

## Hot Surface Hazard

- During use, accessible parts of this appliance will become hot enough to cause burns.
- Do not let your body, clothing or any item other than suitable cookware contact the Induction glass until the surface is cool.
- Metallic objects such as knives, forks, spoons and lids should not be placed on the cooktop surface since they can get hot.
- Keep children away.
- Handles of saucepans may be hot to touch. Check saucepan handles do not overhang other cooking zones that are on. Keep handles out of reach of children.
- Failure to follow this advice could result in burns and scalds.

## Cut Hazard

- The razor-sharp blade of a cooktop scraper is exposed when the safety cover is retracted. Use with extreme care and always store safely and out of reach of children.
- Failure to use caution could result in injury or cuts.



## 03 Important Safety Instructions

- Never leave the appliance unattended when in use. Boil over causes smoking and greasy spillovers that may ignite.
- Never use your appliance as a work or storage surface.
- Never leave any objects or utensils on the appliance.
- Do not place or leave any magnetisable objects(e.g. credit cards, memory cards) or electronic devices(e.g.computers, MP3 players) near the appliance, as they may be affected by its electromagnetic field.
- Never use your appliance for warming or heating the room.
- After use, always turn off the cooking zones and the cooktop as described in this manual(i.e. by using the touch controls). Do not rely on the pan detection feature to turn off the cooking zones when you remove the pans.
- Do not allow children to play with the appliance or sit, stand, or climb on it.
- Do not store items of interest to children in cabinets above the appliance. Children climbing on the cooktop could be seriously injured.
- Do not leave children alone or unattended in the area where the appliance is in use.
- Children or persons with a disability which limits their ability to use the appliance should have a responsible and competent person to instruct them in its use. The instructor should be satisfied that they can use the appliance without danger to themselves or their surroundings.
- Do not repair or replace any part of the appliance unless specifically recommended in the manual. All other servicing should be done by a qualified technician.
- Do not use a steam cleaner to clean your cooktop.
- Do not place or drop heavy objects on your cooktop.
- Do not stand on your cooktop.
- Do not use pans with jagged edges or drag pans across the Induction glass surface as this can scratch the glass.
- Do not use scourers or any other harsh abrasive cleaning agents to clean your cooktop, as these can scratch the Induction glass.
- If the supply cord is damaged, it must be replaced by the manufacturer, its service agent or similarly qualified persons in order to avoid a hazard.
- This appliance is intended to be used in household and similar applications such as: staff kitchen areas in shops, offices and other working environments; farm houses; by clients in hotels, motels and other residential type environments; bed and breakfast type environments.
- **WARNING:** The appliance and its accessible parts become hot during use. Care should be taken to avoid touching heating elements. Children less than 8 years of age shall be kept away unless continuously supervised.



- This appliance can be used by children aged from 8 years and above and persons with reduced physical, sensory or mental capabilities or lack of experience and knowledge if they have been given supervision or instruction concerning use of the appliance in a safe way and understand the hazards involved.
- Children shall not play with the appliance. Cleaning and user maintenance shall not be made by children without supervision.
- **WARNING:** Unattended cooking on the cooktop with fat or oil can be dangerous and may result in fire. Never try to extinguish a fire with water, but switch off the appliance and then cover flame with a lid or a fire blanket.
- **WARNING:** Danger of fire: do not store items on the cooking surfaces.
- **WARNING:** If the surface is cracked, switch off the appliance to avoid the possibility of electric shock.
- A steam cleaner is not to be used.
- The appliance is not intended to be operated by means of an external timer or separate remote-control system.

**CAUTION:** The cooking process has to be supervised. A short term cooking process has to be supervised continuously.

**WARNING:** In order to prevent tipping of the appliance, this stabilizing means must be installed. Refer to the instructions for installation.

Use only cooktop guards designed by the manufacturer of the cooking appliance or indicated by the manufacturer of the appliance in the instruction for use as suitable or cooktop guards incorporated in the appliance. The use of inappropriate guards can cause accidents. This appliance incorporates an earth connection for functional purposes only.

## Congratulations

On the purchase of your new Induction cooktop. We recommend that you spend some time to read this Instruction/Installation Manual in order to fully understand how to install correctly and operate it. For installation, please read the installation section. Read all the safety instructions carefully before use and keep this Instruction/Installation Manual for future reference.



## 05 Product Overview

Top view (IH12BF)

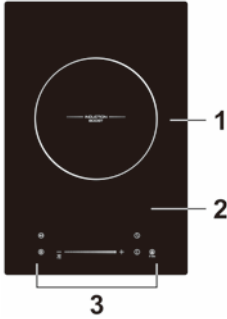

1. 1800W Boost to 2100W zone
2. Glass plate
3. Control panel

Control panel (IH12BF)

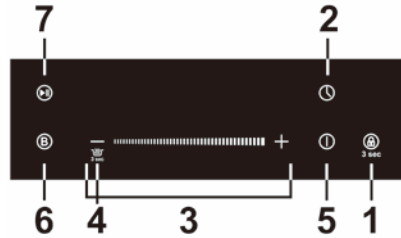

1. Keylock control
2. Timer control
3. Power/Timer regulating key
4. Keep warm function control
5. ON/OFF control
6. Boost function control
7. Stop and go function control

Top view (IH30BF)

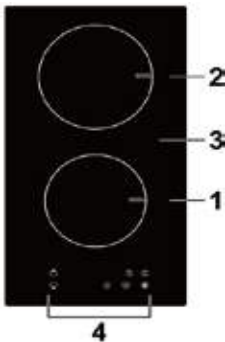

1. Max. 1500W zone
2. Max. 2000W zone
3. Glass plate
4. Control panel

Control panel (IH30BF)

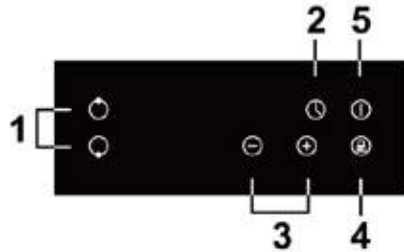

1. Heating zone selection controls
2. Timer control
3. Power/Timer regulating control
4. Key lock control
5. ON/OFF control



Top view (IH60BF)

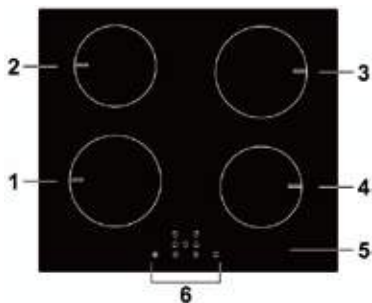

- 1. Max. 2000W zone
- 2. Max. 1500W zone
- 3. Max. 2000W zone
- 4. Max. 1500W zone
- 5. Glass plate
- 6. Control panel

Control panel (IH60BF)

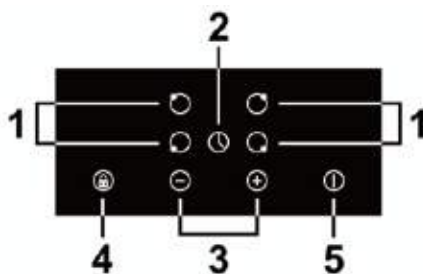

- 1. Heating zone selection controls
- 2. Timer control
- 3. Power/Timer regulating control
- 4. Key lock control
- 5. ON/OFF control

Top view (IH77BF)

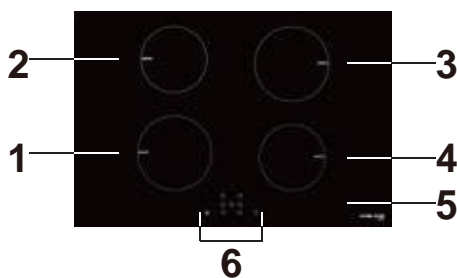

- 1. Max. 2000W zone
- 2. Max. 1500W zone
- 3. Max. 2000W zone
- 4. Max. 1500W zone
- 5. Glass plate
- 6. Control panel

Control panel (IH77BF)

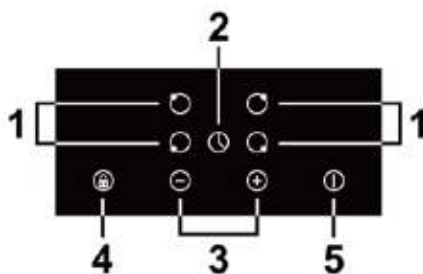

- 1. Heating zone selection controls
- 2. Timer control
- 3. Power/Timer regulating control
- 4. Key lock control
- 5. ON/OFF control



**07** Top view (IH90BF)

Control panel (IH90BF)

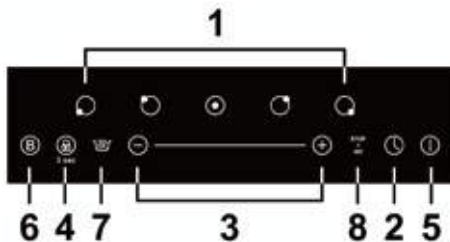
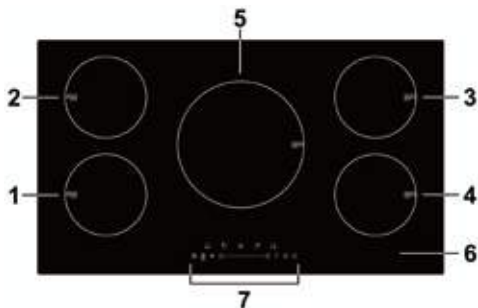

- 1. Max. 2000W boost 2600W zone
- 2. Max. 1500W boost 2000W zone
- 3. Max. 2000W boost 2600W zone
- 4. Max. 1500W boost 2000W zone
- 5. Max. 2300W boost 3000W zone
- 6. Glass plate
- 7. Control panel

- 1. Heating zone selection controls
- 2. Timer control
- 3. Power/Timer regulating control
- 4. Keylock control
- 5. ON/OFF control
- 6. Boost function control
- 7. Keep warm function control
- 8. Stop & go function control

## A Word On Induction Cooking

Induction cooking is a safe, advanced, efficient, and economical cooking technology. It works by electromagnetic vibrations generating heat directly in the pan, rather than indirectly through heating the glass surface. The glass becomes hot only because the pan eventually warms it up.

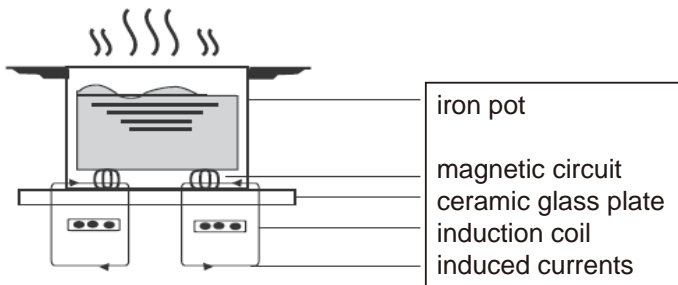



## Before Using Your New Induction Cooktop

- Read this guide, taking special note of the 'Safety Warnings' section.
- Remove any protective film that may still be on your induction cooktop.

## Using The Touch Controls

- The controls respond to touch, so you don't need to apply any pressure.
- Use the ball of your finger, not its tip.
- You will hear a beep each time a touch is registered.
- Make sure the controls are always clean, dry, and that there is no object (e.g. a utensil or a cloth) covering them. Even a thin film of water may make the controls difficult to operate.

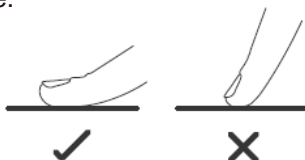

## Choosing The Right Cookware

- ⚠️ • Only use cookware with a base suitable for induction cooking. Look for the induction symbol on the packaging or on the bottom of the pan.
- You can check whether your cookware is suitable by carrying out a magnet test. Move a magnet towards the base of the pan. If it is attracted, the pan is suitable for induction cooking.
- If you do not have a magnet:
  1. Put some water in the pan you want to check.
  2. If 🔥 does not flash in the display and the water is heating, the pan is suitable.
- Cookware made from the following materials is not suitable: pure stainless steel, aluminium or copper without a magnetic base, glass, wood, porcelain, ceramic, and earthenware.



Do not use cookware with jagged edges or a curved base.



- 09** Make sure that the base of your pan is smooth, sits flat against the glass, and is the same size as the cooking zone. Use pans whose diameter is as large as the graphic of the zone selected. Using a pot a slightly wider energy will be used at its maximum efficiency. If you use smaller pot efficiency could be less than expected. Pot less than 5 1/2in could be undetected by the cooktop. Always centre your pan on the cooking zone.

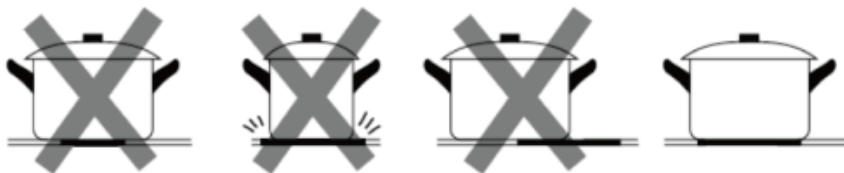

Always lift pans off the induction cooktop – do not slide, or they may scratch the glass.

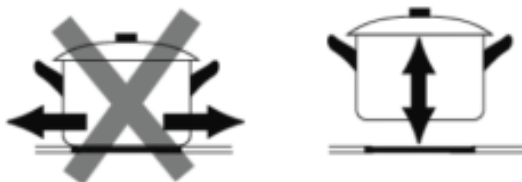

## Using Your Induction Cooktop

To start cooking

1. Touch the ON/OFF control.

After power on, the buzzer beeps once, all displays show “ – “ or “ – – “, indicating that the induction cooktop has entered the state of standby mode.

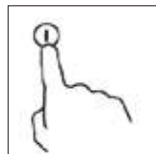

2. Place a suitable pan on the cooking zone that you wish to use.

- Make sure the bottom of the pan and the surface of the cooking zone are clean and dry.

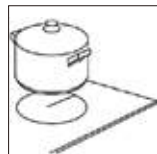

3. Touching the heating zone selection control(for IH30BF/IH60BF/IH77BF/IH90BF) or touching the power regulating control(for IH12BF), and an indicator next to the key will flash.



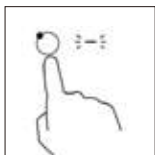

IH30BF/IH60BF/IH77BF/IH90BF

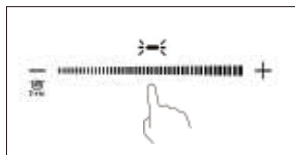

IH12BF

4. Set a power level by touching the “-” and “+”(for IH30BF/IH60BF/IH77BF/IH90BF), or slide along the “—” control(for IH12BF/IH90BF) or just touch any point of the “—”(for IH12BF).

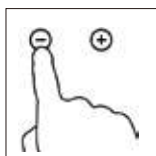

IH30BF/IH60BF/IH77BF/IH90BF

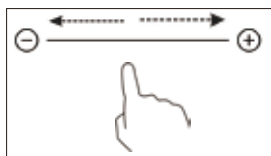

IH90BF

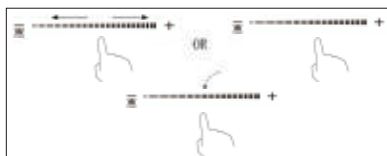

IH12BF

- If you don't set the power within 1 minute, the cooktop will automatically switch off. You will need to start again at step 1.
- You can modify the heat setting at any time during cooking.
- If slide along the “—”, power will vary from stage 2 to stage 8.  
Press “-”, power will decrease by one stage each time till stage 0.  
Press “+”, power will increase by one stage each time till stage 9.

## If The Display Flashes $\geq 9 \leq$ Alternately With The Heat Setting

This means that:

- You have not placed a pan on the correct cooking zone or,
- The pan you're using is not suitable for induction cooking or,
- The pan is too small or not properly centred on the cooking zone.

No heating takes place unless there is a suitable pan on the cooking zone. The display will automatically turn off after 1 minutes if no suitable pan is placed on it.



# 11 When You Have Finished Cooking

1. Touching the heating zone selection control that you wish to switch off.

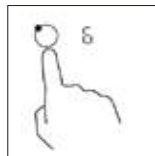

2. Turn the cooking zone off by touching the “-” and scrolling down to “0”.

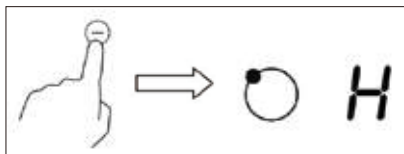

Or slide along the “—” to the left point, and then touch the “-”(for IH12BF/ IH90BF).

Or touch the left point of “—”, and then touching the “-”(for IH12BF).

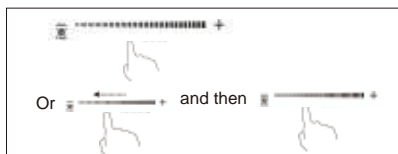

Make sure the power display shows “0”, then shows “H”.

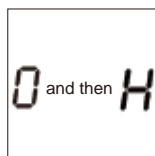

3. Turn the whole cooktop off by touching the ON/OFF control.

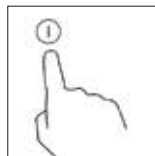

4. Beware of hot surfaces

“H” will show which cooking zone is hot to touch. It will disappear when the surface has cooled down to a safe temperature. It can also be used as an energy saving function if you want to heat further pans, use the hotplate that is still hot.

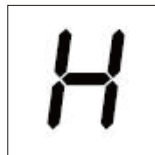

# Using The Boost Function(For IH12BF)

Boost function is the function that one zone rising to a larger power in one second and lasting for 5 minutes. Then you can get a more powerful and faster cooking.

## Using The Boost To Get Larger Power(For IH12BF)

1. Touch the power regulating control, an indicator above the key will flash.

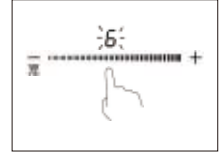

2. Touch the “B” button, the heating zone will begin to work at boost mode. The power display will show “P” to indicate that the zone is boosting.

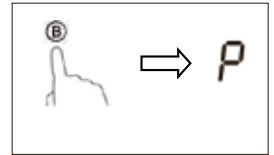

3. The boost power will last for 5 minutes and then the zone will go back to the power stage which was set before boost.



4. If you want to cancel the boost during these 5 minutes, touch the power regulating control and then touch the “B” button. The heating zone will go back to the 9 power stage.

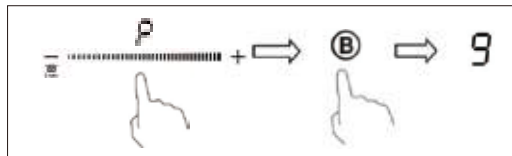

## 13 Using The Boost Function(For IH90BF)

Boost function is the function that one zone rising to a larger power in one second and lasting for 5 minutes. Then you can get a more powerful and faster cooking.

### Using The Boost To Get Larger Power(For IH90BF)

1. Touch the power regulating control, an indicator above the key will flash.

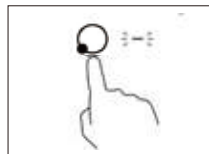

2. Touch the boost button, the heating zone will begin to work at boost mode. The power display will show "P" to indicate that the zone is boosting.

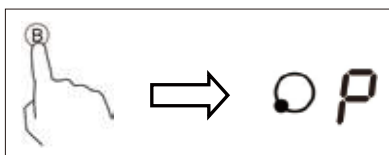

3. The boost power will last for 5 minutes and then the zone will go back to the power stage which was set before boost.

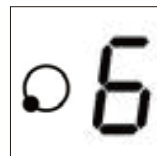

4. If you want to cancel the boost during this 5 minutes, touch the heating zone selection button, an indicator next to the key will flash. And then touch the boost button for a while. The heating zone will go back to the power stage which was set before boost.

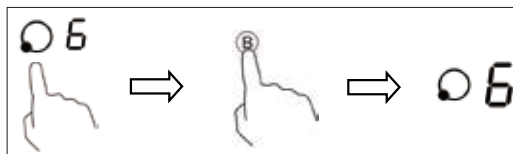

# Restrictions When Using(For IH90BF)

In this cooktop every zone can work with Boost function.

1. In group a, if you need to use boost please decrease the power level of the other zone in the same group to "5" or less first, otherwise "P" and "9" symbols will flash on the display of the selected zone and power level "9" is automatically set. Both zones can be operated with full power as their total power is 3500W.

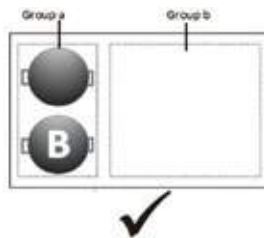

2. In group b, if you want to use boost function, you can only use two zone at the same time.

- a. If you want to use the middle zone's boost function, only one of the zone on the right side can be used at the same time. First make sure the power stage selected zone of the right zone set power stage "4" or less, then set the middle zone boost. If the selected zone on the right side was set higher than "4", the "P" and "9" symbols will flash on the display of the middle zone and power level will be automatically set as 9.

If you change the power stage of the right selected zone while the middle zone working as boost, the boost function will quit automatically.

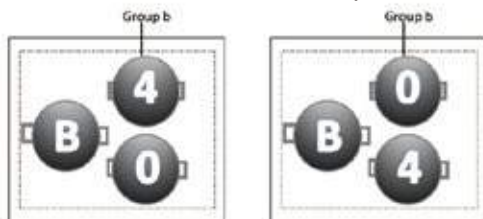

- b. If you want to use the boost function of group b, only two zone can be used at the same time. You need to decrease the power level of the other zone in the same group to "5" or less first, otherwise "P" and "9" symbols will flash on the display of the selected zone and power level "9" is automatically set.

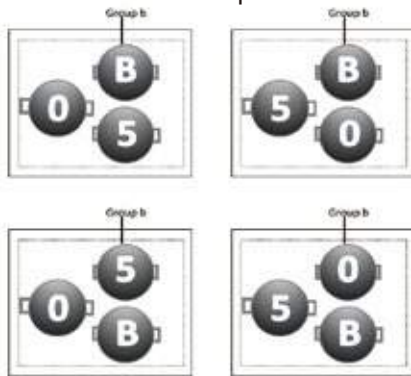

15

3. In group b, you can use three zones at the same time if you don't activate the boost, but the max power level collocation is 7-level, 7-level, 7-level.

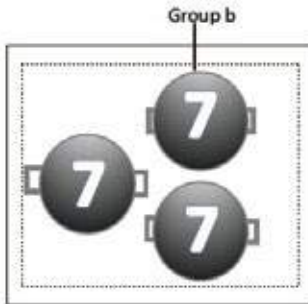

## Power Management Function(For IH90BF)

- Cooking zones are grouped according to the two phases in the cooktop (see illustration). Each phase has a maximum electricity loading of 3500W. The function divides the power between cooking zones connected to the same phase.
- Only Group b has this function. The function will activate when the total electricity loading of the cooking zones exceeds 3500W.
- The function decreases the power to the other cooking zones.

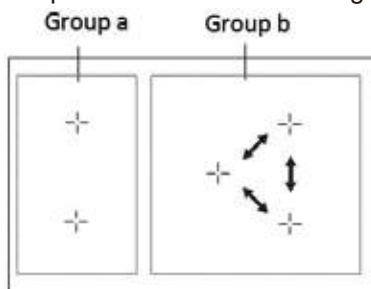

## Using The Pause Function- STOP+GO(For IH12BF)

Pause function can be used at any time during cooking. It allows to stop using and come back to it.

1. Make sure the cook zone is working.
2. Touch the button STOP+GO, the cooking zone indicator will show "II".  
And then the operation of the cooktop will be deactivate within the scope of all cooking zones, except the STOP+GO, on/off and lock keys.





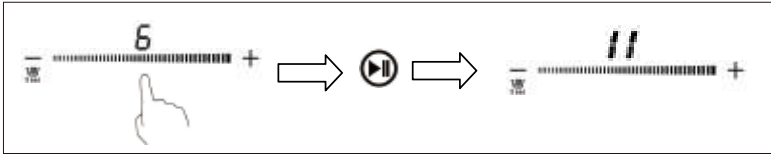

3. To cancel the pause status, touch the button STOP+GO, then the cooking zone will go back to the power stage which you set before.

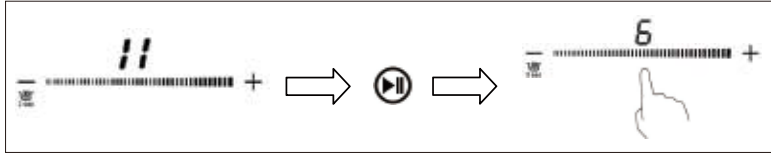

## Using The Pause Function- STOP+GO(For IH90BF)

Pause function can be used at any time during cooking. It allows to stop the induction cooktop and come back to it.

Make sure the cook zone is working.

1. Touch the heating zone selection button that you wish to use STOP + GO, an indicator next to the key will flash.



2. Touch the button STOP+GO, the cooking zone indicator will show "II". And then the operation of the induction cooktop will be deactivate within the scope of all cooking zones, except the STOP+GO, on/off and lock keys.

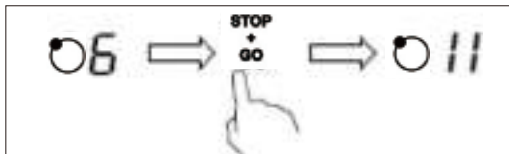

3. To cancel the pause status, touch the button STOP+GO, then the cooking zone will go back to the power stage which you set before.

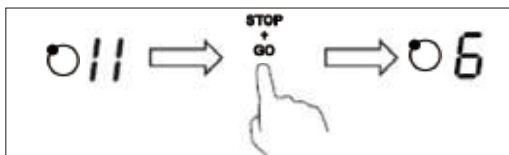

# 17 Using The Keep Warm Function(For IH12BF)

Keep warm function is suitable for keeping food warm for induction cooktop.

## Using The Keep Warm To Get Stable Temperature

1. Touching the power regulating control ,and an indicator above the key will flash.

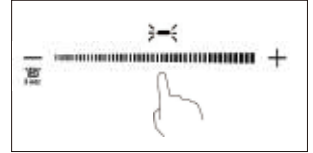

2. Touch the button “-” and hold for 3 seconds in the meantime, the cooking zone indicator will display “A”.

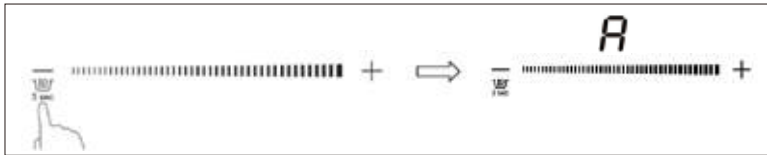

3. If you want to cancel the keep warm, touch the button “-” and hold for 3 seconds in the meantime. The heating zone will go back to “0” power stage.

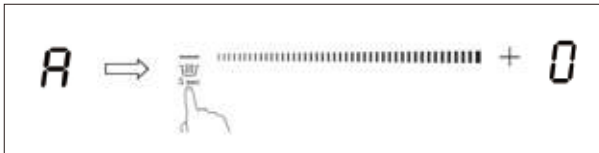

## Using The Keep Warm(For IH90BF)

Keep warm function is suitable for keeping food warm.

## Using The Keep Warm To Get Stable Temperature

1. Touch the heating zone selection button that you wish to use keep warm, an indicator next to the key will flash.



2. Touch the keep warm function control, the cooking zone indicator will display "A".

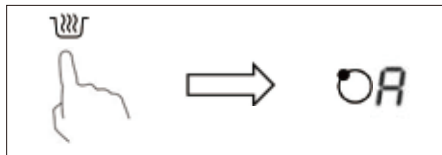

3. If you want to cancel the keep warm, touch the heating zone selection button, an indicator next to the key will flash. And then touch the keep warm function control, the heating zone will go back to "0" power stage.

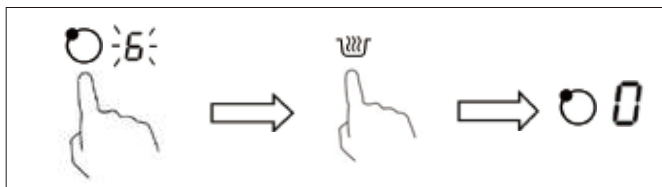

## Locking The Controls

- You can lock the controls to prevent unintended use(for example children accidentally turning the cooking zones on).
- When the controls are locked, all the controls except the ON/OFF control are disabled.

### To lock the controls

Touch and hold the keylock control for 3 secnd. The timer indicator will show "Lo".

### To unlock the controls

1. Make sure the cooktop is turned on.
2. Touch and hold the keylock control for 3 second.
3. You can now start using your cooktop.

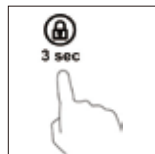

When the cooktop is in the lock mode,all the controls are disable except the ON/OFF , you can always turn the cooktop off with the ON/OFF control in an emergency, but you shall unlock the cooktop first in the next operation.



## 19 Over-Temperature Protection

A temperature sensor equipped can monitor the temperature inside the induction cooktop. When an excessive temperature is monitored, the induction cooktop will stop operation automatically.

### Residual Heat Warning

When the cooktop has been operating for some time, there will be some residual heat. The letter “ H ” appears to warn you to keep away from it.

### Detection Of Small Articles For Induction Cooktop

When an unsuitable size or non-magnetic pan(e.g. aluminium), or some other small item(e.g. knife, fork, key) has been left on the cooktop, the cooktop automatically go on to standby in 1 minute. The fan will keep cooking down the induction cooktop for a further 1 minute.

### Auto Shutdown

Another safety feature of the cooktop is auto shutdown. This occurs whenever you forget to switch off a cooking zone. The default shutdown times are shown in the table below:

Power level	1	2	3	4	5	6	7	8	9
Default working timer(hour)	8	8	8	4	4	4	2	2	2



People with a heart pace maker should consult with their doctor before using this unit.

### Using The Timer

You can use the timer in two different ways:

- You can use it as a minute minder. In this case, the timer will not turn any cooking zone off when the set time is up.
- You can set it to turn one cooking zone off after the set time is up.
- You can set the timer up to 99 minutes.



## Using The Timer As A Minute Minder

If you are not selecting any cooking zone

1. Make sure the cooktop is turned on.

NOTE: you can use the minute minder even if you're not selecting any cooking zone.

2. Touch timer control, the minder indicator will start flashing and "30" will show in the timer display.

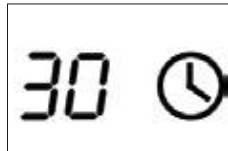

3. Adjust the timer setting by touch the "-" or "+" controls. The minute minder indicator will start flashing and will show in the timer display.

Hint: Touch the "-" or "+" control of the timer once to decrease or increase by 1 minute. Touch and hold the "-" or "+" control of the timer to decrease or increase by 10 minutes. If the setting time exceeds 99 minutes, the timer will automatically return to 0 minute.

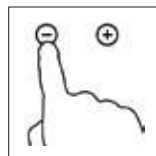

4. To cancel the timer, touch the timer control, and the "--" will show in the minute display.

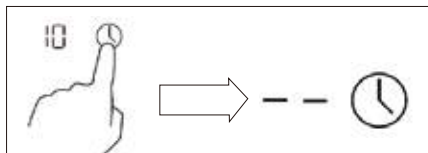

5. When the time is set, it will begin to count down immediately. The display will show the remaining time and the timer indicator will flash for 5 seconds.



6. Buzzer will beep for 30 seconds and the timer indicator shows "--" when the setting time finished.

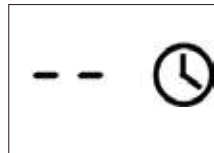

NOTE: The cooktop will continue to cook, this timer function is a minute minder only, it does not turn the cooktop off.



## 21 Setting The Timer To Turn One Cooking Zone Off

1. Touching the heating zone selection control that you want to set the timer for.



2. Touch timer control, the minder indicator will start flashing and "30" will show in the timer display.

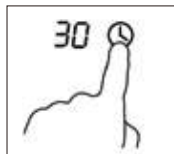

3. Set the time by touching the or control of the timer.  
Hint: Touch the "-" or "+" control of the timer once will decrease or increase by 1 minute. Touch and hold the "-" or "+" control of the timer will decrease or increase by 10 minutes. If the setting time exceeds 99 minutes, the timer will automatically return to 0 minute.

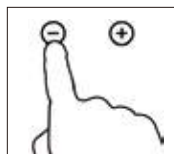

4. To cancel the timer, touch the heating zone selection control, and then touch the timer control. The minute display will show "--".

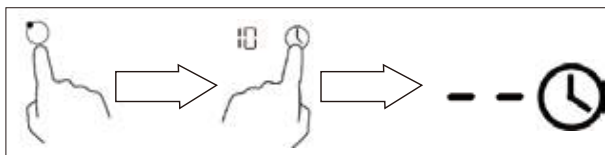

5. When the time is set, it will begin to count down immediately. The display will show the remaining time and the timer indicator flash for 5 seconds.



NOTE: The red dot next to power level indicator will illuminate indicating that zone is selected.

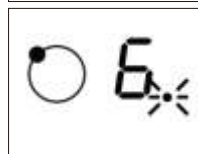

6. When cooking timer expires, the corresponding cooking zone will be switch off automatically.

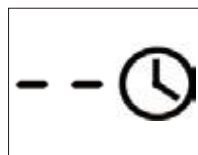

 Other cooking zone will keep operating if they are turned on previously.



## Setting The Timer To Turn More Than One Cooking Zone Off

1. If more than one heating zone use this function, the timer indicator will show the lowest time. (e.g. zone 2# setting time of 3 minutes, zone 3# setting time of 6 minutes, the timer indicator shows “3”.)

NOTE: The red dot next to power level indicator will flash.

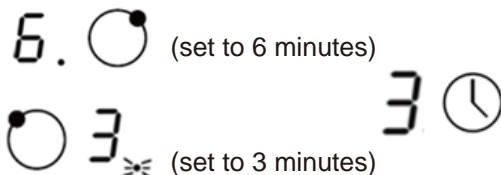

2. When cooking timer expires, the corresponding cooking zone will be switch off automatically.

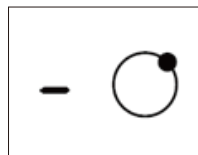

NOTE: If you want to change the time after the timer is set, you have to start from step 1.

## Cooking Guidelines

 Take care when frying as the oil and fat heat up very quickly, particularly if you're using Power Boost. At extremely high temperature oil and fat will ignite spontaneously and this presents a serious fire risk.

## Cooking Tips

- When food comes to the boil, reduce the temperature setting.
- Using a lid will reduce cooking times and save energy by retaining the heat.
- Minimize the amount of liquid or fat to reduce cooking times.
- Start cooking on a high setting and reduce the setting when the food has heated through.



## 23 Simmering, Cooking Rice

- Simmering occurs below boiling point, at around 85°C(185°F), when bubbles are just rising occasionally to the surface of the cooking liquid. It is the key to delicious soups and tender stews because the flavor develop without overcooking the food. You should also cook egg-based and flour thickened sauces below boiling point.
- Some tasks, including cooking rice by the absorption method, may require a setting higher than the lowest setting to ensure the food is cooked properly in the time recommended.

## Searing Steak

To cook juicy flavor some steaks:

1. Stand the meat at room temperature for about 20 minutes before cooking.
2. Heat up a heavy-based frying pan.
3. Brush both sides of the steak with oil. Drizzle a small amount of oil into the hot pan and then lower the meat onto the hot pan.
4. Turn the steak only once during cooking. The exact cooking time will depend on the thickness of the steak and how cooked you want it. Times may vary from about 2–8 minutes per side. Press the steak to gauge how cooked it is the firmer it feels the more “well done” it will be.
5. Leave the steak to rest on a warm plate for a few minutes to allow it to relax and become tender before serving.

## For Stir-frying

1. Choose an induction compatible flat-based wok or a large frying pan.
2. Have all the ingredients and equipment ready. Stir-frying should be quick. If cooking large quantities, cook the food in several smaller batches.
3. Preheat the pan briefly and add two tablespoons of oil.
4. Cook any meat first, put it aside and keep warm.
5. Stir-fry the vegetables. When they are hot but still crisp, turn the cooking zone to a lower setting, return the meat to the pan and add your sauce.
6. Stir the ingredients gently to make sure they are heated through.
7. Serve immediately.





## Heat Settings

The settings below are guidelines only. The exact setting will depend on several factors, including your cookware and the amount you are cooking. Experiment with the induction cooktop to find the settings that best suit you.

Heat setting	Suitability
1 - 2	<ul style="list-style-type: none"> <li>• Delicate warming for small amounts of food</li> <li>• Melting chocolate, butter, and foods that burn quickly</li> <li>• Gentle simmering</li> <li>• Slow warming</li> </ul>
3-4	<ul style="list-style-type: none"> <li>• Reheating</li> <li>• Rapid simmering</li> <li>• Cooking rice</li> </ul>
5-6	<ul style="list-style-type: none"> <li>• Pancakes</li> </ul>
7-8	<ul style="list-style-type: none"> <li>• Sauteing</li> <li>• Cooking pasta</li> </ul>
9	<ul style="list-style-type: none"> <li>• Stir-frying</li> <li>• Searing</li> <li>• Bringing soup to the boil</li> <li>• Boiling water</li> </ul>



## 25 Care And Cleaning

What?	How?	Important!
<p>Everyday soiling on glass(fingerprints, marks, stains left by food or non-sugary spillovers on the glass)</p>	<ol style="list-style-type: none"> <li>1. Switch the power to the cooktop off.</li> <li>2. Apply a cooktop cleaner while the glass is still warm(but not hot!)</li> <li>3. Rinse and wipe dry with a clean cloth or paper towel.</li> <li>4. Switch the power to the cooktop back on.</li> </ol>	<ul style="list-style-type: none"> <li>• When the power of the cooktop is switched off, there will be no 'hot surface' indication but the cooking zone may still be hot! Take extreme care.</li> <li>• Heavy-duty scourers, some nylon scourers and harsh/abrasive cleaning agents may scratch the glass. Always read the label to check if your cleaner or scourer is suitable.</li> <li>• Never leave cleaning residue on the cooktop: the glass may become stained.</li> </ul>
<p>Boilovers, melts, and hot sugary spills on the glass</p>	<p>Remove these immediately with a fish slice, palette knife or razor blade scraper suitable for Induction glass cooktops, but beware of hot cooking zone surfaces:</p> <ol style="list-style-type: none"> <li>1. Switch the power to the cooktop off at the wall.</li> <li>2. Hold the blade or utensil at a 30° angle and scrape the soiling or spill to a cool area of the cooktop.</li> <li>3. Clean the soiling or spill up with a dish cloth or paper towel.</li> <li>4. Follow steps 2 to 4 for "Everyday soiling on glass" above.</li> </ol>	<ul style="list-style-type: none"> <li>• Remove stains left by melts and sugary food or spillovers as soon as possible. If left to cool on the glass, they may be difficult to remove or even permanently damage the glass surface.</li> <li>• Cut hazard: when the safety cover is retracted, the blade in a scraper is razor-sharp. Use with extreme care and always store safely and out of reach of children.</li> </ul>
<p>Spillovers on the touch controls</p>	<ol style="list-style-type: none"> <li>1. Switch the power to the cooktop off.</li> <li>2. Soak up the spill</li> <li>3. Wipe the touch control area with a clean damp sponge or cloth.</li> <li>4. Wipe the area completely dry with a paper towel.</li> <li>5. Switch the power to the cooktop back on.</li> </ol>	<ul style="list-style-type: none"> <li>• The cooktop may beep and turn itself off, and the touch controls may not function while there is liquid on them. Make sure you wipe the touch control area dry before turning the cooktop back on.</li> </ul>



## Hints And Tips

Problem	Possible causes	What to do
The induction cooktop cannot be turned on.	No power.	Make sure the induction cooktop is connected to the power supply and that it is switched on. Check whether there is a power outage in your home or area. If you've checked everything and the problem persists, call a qualified technician.
The touch controls are unresponsive.	The controls are locked.	Unlock the controls. See section 'Using your induction cooktop' for instructions
The touch controls are difficult to operate.	There may be a slight film of water over the controls or you may be using the tip of your finger when touching the controls.	Make sure the touch control area is dry and use the ball of your finger when touching the controls.
The glass is being scratched.	Rough-edged cookware.	Use cookware with flat and smooth bases. See 'Choosing the right cookware'.
	Unsuitable, abrasive scourer or cleaning products being used.	See 'Care and cleaning'.
Some pans make crackling or clicking noises.	This may be caused by the construction of your cookware (layers of different metals vibrating differently).	This is normal for cookware and does not indicate a fault.
The induction cooktop makes a low humming noise when used on a high heat setting.	This is caused by the technology of induction cooking.	This is normal, but the noise should quieten down or disappear completely when you decrease the heat setting
Fan noise coming from the induction cooktop.	A cooling fan built into your induction cooktop has come on to prevent the electronics from overheating. It may continue to run even after you've turned the induction cooktop off.	This is normal and needs no action. Do not switch the power to the induction cooktop off at the wall while the fan is running.



Pans do not become hot and appears in the display.	The induction cooktop cannot detect the pan because it is not suitable for induction cooking.	Use cookware suitable for induction cooking. See section 'Choosing the right cookware'.
	The induction cooktop cannot detect the pan because it is too small for the cooking zone or not properly centred on it.	Centre the pan and make sure that its base matches the size of the cooking zone.
The induction cooktop or a cooking zone has turned itself off unexpectedly, a tone sounds and an error code is displayed (typically alternating with one or two digits in the cooking timer display).	Technical fault.	Please note down the error letters and numbers, switch the power to the induction cooktop off at the wall, and contact a qualified technician

## Failure Display And Inspection

If an abnormality comes up, the induction cooktop will enter the protective state automatically and display corresponding protective codes:

Problem	Possible causes	What to do
F3/F4	Temperature sensor of the induction coil failure	Please contact the supplier.
F9/FA	Temperature sensor of the IGBT failure.	Please contact the supplier.
E1/E2	Abnormal supply voltage	Please inspect whether power supply is normal. Power on after the power supply is normal.
E3	High temperature of the induction coil temperature sensor	Please contact the supplier.
E5	High temperature of the IGBT temperature sensor	Please restart after the cooktop cools down.



The above are the judgment and inspection of common failures. Please do not disassemble the unit by yourself to avoid any dangers and damages to the induction cooktop.

Model	IH12BF	IH30BF	IH60BF	IH77BF	IH90BF
Cooking Zones	1 Zones	2 Zones	4 Zones	4 Zones	5 Zones
Supply Voltage	220-240V~	220-240V~	220-240V~	220-240V~	220-240V~
Frequency	50-60Hz	50-60Hz	50-60Hz	50-60Hz	50-60Hz
Rating Power	1800W	3000-3800W	6600-7400W	6600-7400W	6800-7400W
Product Size	11 <sup>1</sup> / <sub>8</sub> "x17 <sup>3</sup> / <sub>4</sub> "x2 <sup>1</sup> / <sub>2</sub> "	11 <sup>1</sup> / <sub>2</sub> "x20 <sup>1</sup> / <sub>2</sub> "x 2 <sup>1</sup> / <sub>2</sub> "	23 <sup>1</sup> / <sub>5</sub> "x20 <sup>1</sup> / <sub>2</sub> "x2 <sup>1</sup> / <sub>5</sub> "	30 <sup>1</sup> / <sub>5</sub> "x20 <sup>1</sup> / <sub>2</sub> "x2 <sup>1</sup> / <sub>5</sub> "	35 <sup>2</sup> / <sub>5</sub> "x20 <sup>1</sup> / <sub>2</sub> "x2 <sup>2</sup> / <sub>5</sub> "
Built-in Dimension	10 <sup>3</sup> / <sub>4</sub> "x16"	10 <sup>3</sup> / <sub>5</sub> "x19 <sup>1</sup> / <sub>5</sub> "	22 <sup>1</sup> / <sub>5</sub> "x19 <sup>2</sup> / <sub>5</sub> "	22 <sup>1</sup> / <sub>5</sub> "x19 <sup>2</sup> / <sub>5</sub> "	34 <sup>1</sup> / <sub>3</sub> "x19 <sup>1</sup> / <sub>3</sub> "

Weight and Dimensions are approximate. Because we continually strive to improve our products we may change specifications and designs without prior notice.

## Installation Selection Of Installation Equipment

Cut out the work surface according to the sizes shown in the drawing. For the purpose of installation and use, a minimum of 2 inch space shall be preserved around the hole.

Be sure the thickness of the work surface is at least 1<sup>1</sup>/<sub>5</sub> inch . Please select heat-resistant work surface material to avoid larger deformation caused by the heat radiation from the hotplate. As shown below :

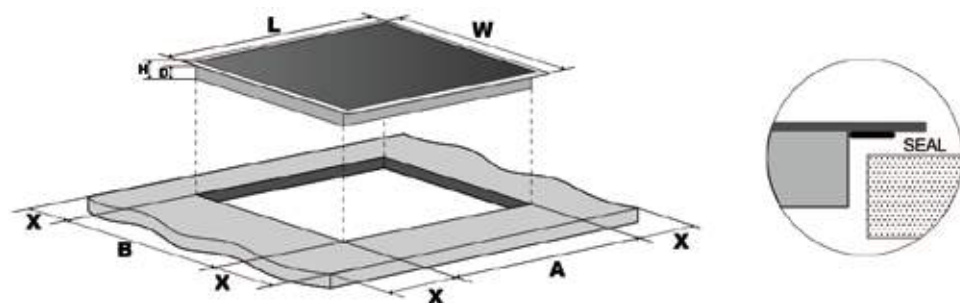

Model	L	W	H	D	A	B	X
IH12BF	11 <sup>4</sup> / <sub>5</sub> "	17 <sup>3</sup> / <sub>4</sub> "	2 <sup>1</sup> / <sub>2</sub> "	2 <sup>1</sup> / <sub>3</sub> "	10 <sup>3</sup> / <sub>4</sub> "	16"	2" mini
IH30BF	11 <sup>1</sup> / <sub>2</sub> "	20 <sup>1</sup> / <sub>2</sub> "	2 <sup>1</sup> / <sub>2</sub> "	2 <sup>2</sup> / <sub>5</sub> "	10 <sup>3</sup> / <sub>5</sub> "	19 <sup>4</sup> / <sub>5</sub> "	2" mini
IH60BF	23 <sup>1</sup> / <sub>5</sub> "	20 <sup>1</sup> / <sub>2</sub> "	2 <sup>1</sup> / <sub>5</sub> "	2"	22 <sup>1</sup> / <sub>5</sub> "	19 <sup>2</sup> / <sub>5</sub> "	2" mini
IH77BF	30 <sup>1</sup> / <sub>5</sub> "	20 <sup>1</sup> / <sub>2</sub> "	2 <sup>1</sup> / <sub>5</sub> "	2"	22 <sup>1</sup> / <sub>5</sub> "	19 <sup>2</sup> / <sub>5</sub> "	2" mini
IH90BF	35 <sup>2</sup> / <sub>5</sub> "	20 <sup>1</sup> / <sub>2</sub> "	2 <sup>2</sup> / <sub>5</sub> "	2 <sup>2</sup> / <sub>5</sub> "	34 <sup>1</sup> / <sub>3</sub> "	19 <sup>1</sup> / <sub>3</sub> "	2" mini

Under any circumstances, make sure the Induction cooktop is well ventilated and the air inlet and outlet are not blocked. Ensure the Induction cooktop is in good work state. As shown below.

 **NOTE:** The safety distance between the hotplate and the cupboard above the hotplate should be at least 30 inch.

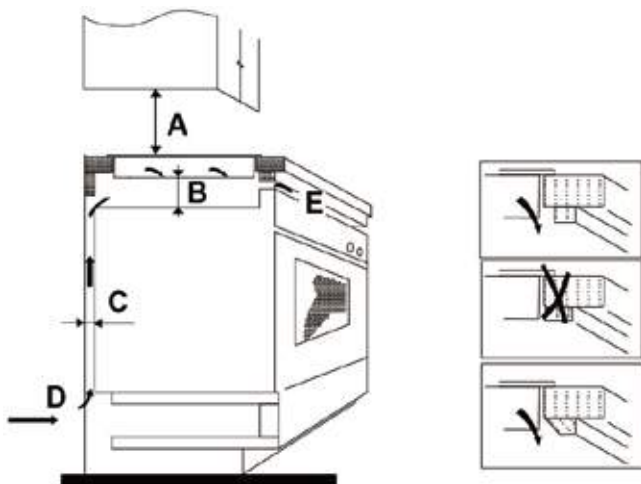

A	B	C	D	E
30"	2" mini	<sup>4</sup> / <sub>5</sub> " mini	Air intake	Air exit <sup>1</sup> / <sub>5</sub> "



## Before You Install The Cooktop, Make Sure That

- The work surface is square and level, and no structural members interfere with space requirements.
- The work surface is made of a heat-resistant material.
- If the cooktop is installed above an oven, the oven has a built-in cooling fan
- The installation will comply with all clearance requirements and applicable standards and regulations.
- A suitable isolating switch providing full disconnection from the mains power supply is incorporated in the permanent wiring, mounted and positioned to comply with the local wiring rules and regulations.  
The isolating switch must be of an approved type and provide a 3 mm air gap contact separation in all poles(or in all active phase conductors if the local wiring rules allow for this variation of the requirements).
- The isolating switch will be easily accessible to the customer with the cooktop installed.
- You consult local building authorities and by-laws if in doubt regarding installation.
- You use heat-resistant and easy-to-clean finishes(such as ceramic tiles) for the wall surfaces surrounding the cooktop.

## When You Have Installed The Cooktop, Make Sure That

- The power supply cable is not accessible through cupboard doors or drawers.
- There is adequate flow of fresh air from outside the cabinetry to the base of the cooktop.
- If the cooktop is installed above a drawer or cupboard space, a thermal protection barrier is installed below the base of the cooktop.
- The isolating switch is easily accessible by the customer

## Before Locating The Fixing Brackets

The unit should be placed on a stable, smooth surface(use the packaging). Do not apply force onto the controls protruding from the cooktop.

## Adjusting The Bracket Position

Fix the cooktop on the work surface by screw 4 brackets on the bottom of cooktop(see picture) after installation.



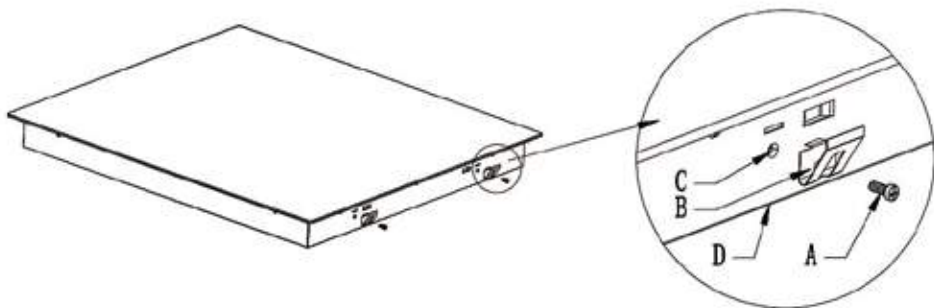

<b>A</b>	<b>B</b>	<b>C</b>	<b>D</b>
Screw	Bracket	Screw Hole	Bottom Base

Worktop/Kitchen cabinet

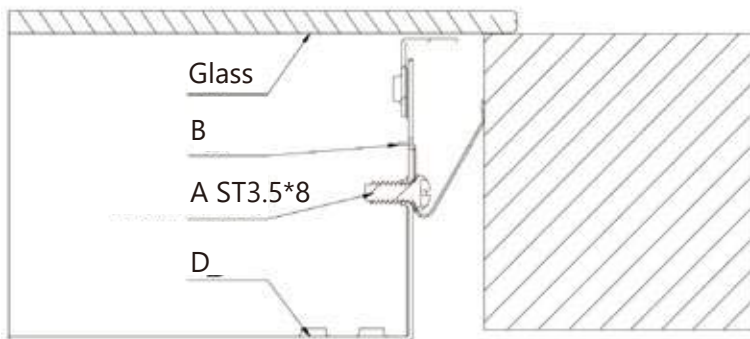



## Cautions

1. The induction cooktop must be installed by qualified personnel or technicians. We have professionals at your service. Please never conduct the operation by yourself.
2. The cooktop will not be installed directly above a dishwasher, fridge, freezer, washing machine or clothes dryer, as the humidity may damage the cooktop electronics.
3. The induction cooktop shall be installed such that better heat radiation can be ensured to enhance its reliability.
4. The wall and induced heating zone above the table surface shall withstand heat.
5. To avoid any damage, the sandwich layer and adhesive must be resistant to heat.

## Connecting The Cooktop To The Mains Power Supply

The power supply should be connected in compliance with the relevant standard, or a single-pole circuit breaker. The method of connection is shown below.

1. If the cable is damaged or needs replacing, this should be done by an after-sales technician using the proper tools, so as to avoid any accidents.
2. If the appliance is being connected directly to the mains supply, an omnipolar circuit breaker must be installed with a minimum gap of 0.11 in between the contacts.
3. The installer must ensure that the correct electrical connection has been made and that it complies with safety regulations.
4. The cable must not be bent or compressed.
5. The cable must be checked regularly and only replaced by a properly qualified person.



**33** Model: IH12BF

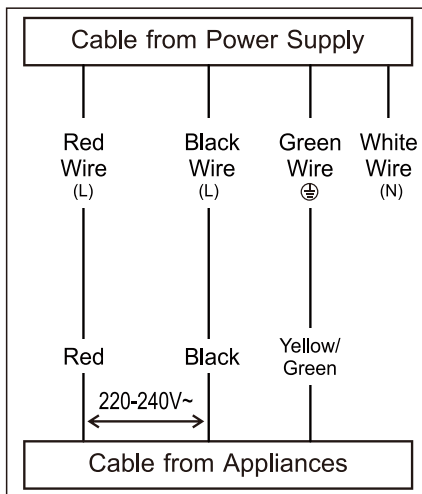

Model: IH30BF

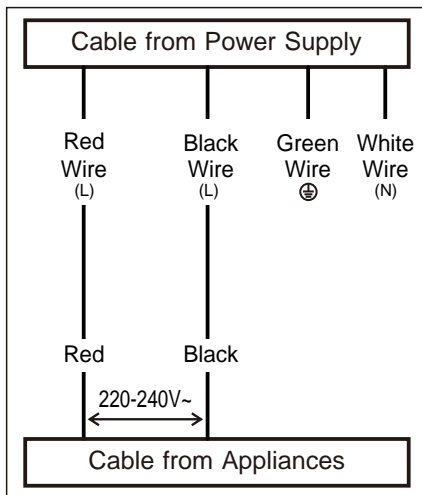

Model: IH60BF, IH77BF, IH90BF

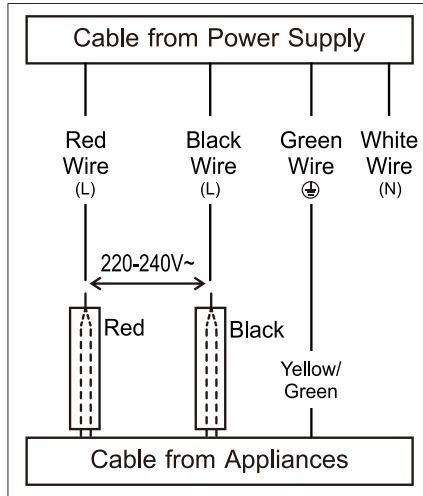



(844) 538-7890 [www.gaslandchef.com](http://www.gaslandchef.com) [support@gaslandchef.com](mailto:support@gaslandchef.com)

