



PRODUCT CATALOG

PHITHAKSAKORN (A.E.C. 2015) Co.,Ltd.



C *ONTENT*

Food Container	1
- Seal n' Fresh	1
- Indicator Timer	4
- Diamond Style	5
- Sandwich Box	6
Kitchenwares	9
- Canister	11
- Cup	12
- Ice Cube Tray, Jug, Tray, Seasoning Case	13
Housewares	14
- Hanger & Clips	15
- Soap Case, Stool	17
Part Case	18
Basket	21
- Laundry Basket	23
Basin	26
Bucket	27
Cooler Box	29
- Fishing Cooler Box	31
- Smart Cooler Box	32
- Colorado Cooler Box	33
- D - Series	34
Dog House	35
Office Supplies	36
Drawer	38
Dust Bin	41
Shoe Rack	42
Storage Box	43
Container	45
Stopper	46
Miscellaneous	47

AIRTIGHT FOOD STORAGE CONTAINERS



Material is approved
for food use.



Dish washer safe
on top rack.



Dish washer safe.



Microwave
oven safe.



Safe for use
on freezer.



S Food container SEAL N' FRESH



ผลิตจากวัสดุคุณภาพดี
ปลอดสารก่อมะเร็ง



AG 415
Size: Ø 10 x 6.8
Cap: 0.3 Lt.



AG 416
Size: Ø 12 x 9.3
Cap: 0.6 Lt.



AG 417
Size: Ø 15 x 11.8
Cap: 1.2 Lt.



AG 421
Size: 17 x 22 x 6.8
Cap: 1.5 Lt.



AG 422
Size: 20.2 x 26 x 8.5
Cap: 2.7 Lt.



AG 451
Size: 17 x 22 x 9.3
Cap: 2.10 Lt.

AG 452
Size: 20.3 x 26 x 11
Cap: 3.7 Lt.



AG 425
Size: Ø 20 x 8.2
Cap: 1.89 Lt.



AG 426
Size: Ø 20 x 10.6
Cap: 2.6 Lt.



AG 441
Size: 8.5 x 16.3 x 5.2
Cap: 0.4 Lt.

AG 442
Size: 11 x 19 x 6.5
Cap: 0.8 Lt.

AG 443
Size: 13.3 x 21.7 x 7.8
Cap: 1.5 Lt.

AG 444
Size: 15.6 x 24.5 x 9
Cap: 2.4 Lt.

AG 445
Size: 18 x 27.3 x 10.5
Cap: 3.6 Lt.

AG 446
Size: 20.5 x 30.2 x 11.7
Cap: 5.2 Lt.



Food container

INDICATOR TIMER



AG 381i
Size: 6.7 x 12.3 x 4.6
Cap: 0.2 Lt.



AG 382i
Size: 9.1 x 15.1 x 6
Cap: 0.45 Lt.



AG 383i
Size: 11.8 x 17.7 x 7.2
Cap: 0.85 Lt.



AG 384i
Size: 14 x 20.7 x 8.5
Cap: 1.5 Lt.



AG 385i
Size: 16.6 x 23.5 x 10
Cap: 2.4 Lt.



AG 386i
Size: 19 x 26.3 x 11.5
Cap: 3.8 Lt.



AG 387i
Size: 22 x 29.5 x 13
Cap: 5.6 Lt.



AG 388i
Size: 22 x 22 x 12.5
Cap: 4 Lt.



AG 389i
Size: 25.7 x 25.7 x 14.5
Cap: 6.5 Lt.



AG 390i
Size: 29.5 x 29.5 x 16.5
Cap: 10.3 Lt.



Material is approved
for food use.



Dish washer safe
on top rack.



Dish washer safe.



Microwave
oven safe.



Safe for use
on freezer.



ผลิตจากวัสดุคุณภาพดี
ปลอดสารก่อมะเร็ง

Food container

IAMOND STYLE

ED



Material is approved
for food use.



Dish washer safe
on top rack.



Dish washer safe.



Microwave
oven safe.



Safe for use
on freezer.



ผลิตจากวัสดุที่
ปลอดภัยต่อมะเร็ง



AG 381

Size: 6.7 x 12.3 x 4.6

Cap: 0.2 Lt.

AG 382

Size: 9.1 x 15.1 x 6

Cap: 0.45 Lt.

AG 383

Size: 11.8 x 17.7 x 7.2

Cap: 0.85 Lt.

AG 384

Size: 14 x 20.7 x 8.5

Cap: 1.5 Lt.

AG 385

Size: 16.6 x 23.5 x 10

Cap: 2.4 Lt.

AG 386

Size: 19 x 26.3 x 11.5

Cap: 3.8 Lt.

AG 387

Size: 22 x 29.5 x 13

Cap: 5.6 Lt.

Color  



Material is approved for food use.



Microwave oven safe.



Dish washer safe on top rack.



Safe for use on freezer.



Dish washer safe.



ผลิตจากวัสดุที่ปลอดภัย
ปลอดสารก่อมะเร็ง

S

Food container

ANDWICH BOX



AG 248
Size: 11.7 x 16.7 x 4.3



AG 255
Size: 12.7 x 18 x 4.8



AG 243
Size: 10.5 x 15 x 4



AG 260
Size: 13 x 18.5 x 5

FOOD CONTAINER



Material is approved for food use.



Dish washer safe on top rack.



Dish washer safe.



Microwave oven safe.



Safe for use on freezer.



ผลิตจากวัสดุคุณภาพดี
ปลอดสารก่อมะเร็ง



AG 301
Size: Ø 9.2 x 8.5
Cap: 0.3 Lt.



AG 302
Size: Ø 12.4 x 9.5
Cap: 0.6 Lt.



AG 303
Size: Ø 15 x 11.3
Cap: 1.2 Lt.



AG 304
Size: Ø 17.5 x 13.1
Cap: 2.1 Lt.



AG 305
Size: Ø 20.2 x 15.1
Cap: 3.3 Lt.



AG 001
Size: 31.5 x 20 x 13.2

AG 003
Size: 25 x 16.5 x 9



AG 275
Size: 13.5 x 14 x 6.5



AG 311
Size: 7.5 x 11.6 x 5
Cap: 0.25 Lt.

AG 312
Size: 10 x 14.3 x 6.7
Cap: 0.5 Lt.

AG 313
Size: 12.5 x 17.5 x 8.5
Cap: 1.2 Lt.

AG 314
Size: 15 x 20 x 10.6
Cap: 2.1 Lt.

AG 322
Size: 13.7 x 24 x 7
Cap: 1.65 Lt.

AG 323
Size: 16.2 x 26.7 x 8
Cap: 2.65 Lt.

AG 324
Size: 18.8 x 29 x 9.5
Cap: 4.1 Lt.



AG 331
Size: 8.5 x 8.5 x 5.5
Cap: 0.2 Lt.

AG 332
Size: 11 x 11 x 6.5
Cap: 0.4 Lt.

AG 333
Size: 13.5 x 13.5 x 7.7
Cap: 0.73 Lt.

AG 334
Size: 16.3 x 16.3 x 8.2
Cap: 1.25 Lt.

K



ITCHENWARES



AG 01
Size: Ø 16 cms.



AG 02
Size: Ø 13.5 cms.



AG 03
Size: Ø 10 cms.



AG 04
Size: Ø 8.5 cms.



AG 05
Size: Ø 8 cms.



AG 261
Size: 21 cm.



AG 207
Size: Ø 17.7 x 2



AG 208
Size: Ø 19.5 x 2.2



AG 209
Size: Ø 21.7 x 2.4



AG 237
Size: Ø 6.3 x 1.5



AG 244
Size: Ø 8.5 x 3.9



AG 461
Size: Ø 18.5 x 3.5



AG 462
Size: Ø 22 x 1.7



AG 463
Size: 22.5 x 29 x 2



Spoon
AG 464
Size: 5.5 cm.

Fork
AG 465
Size: 5.5 cm.



AG 320
Size: 33.5 x 49 x 14.5



AG 469
Size: 17.5 x 29.5 x 16



AG 318
Size: Ø 8 x 15.5

C

Kitchenwares ANISTER



Material is approved
for food use.



Dish washer safe
on top rack.



Dish washer safe.



Microwave
oven safe.



Safe for use
on freezer.



ผลิตจากวัสดุคุณภาพดี
ปลอดสารก่อมะเร็ง



AG 289
Size: ø 14.3 x 15
Cap: 1750 ml



AG 289/3
Size: ø 10.5 x 10.7
Cap: 1000 ml



AG 289/1
Size: ø 13 x 13.6
Cap: 1500 ml



AG 289/4
Size: ø 9.5 x 9.6
Cap: 750 ml



AG 289/2
Size: ø 11.7 x 12.5
Cap: 1250 ml



AG 289/5
Size: ø 8.5 x 9
Cap: 500 ml



Kitchenwares

UP



AG 264
Size: $\varnothing 7.5 \times 9.6 \times 7.7$



AG 200
Size: $\varnothing 6.2 \times 8.4$



AG 232
Size: $\varnothing 7.1 \times 8.5$



AG 402
Size: $\varnothing 7.7 \times 16.6$



AG 404
Size: $\varnothing 8.9 \times 18.4$



AG 406
Size: $\varnothing 11.9 \times 16$

Ice cube tray



AG 213
Size: 11.8 x 19 x 3.2



AG 214
Size: 11.8 x 25 x 3.2

Jug

AG 269
Size: 10.5 x 18
Cap: 1 Lts.

AG 267
Size: 12 x 19
Cap: 1.4 Lts

AG 268
Size: 13 x 24
Cap: 2 Lts.



Tray



AG 262
Size: 28.3 x 38 x 2.1



AG 273
Size: 22.5 x 28.5 x 2.6



AG 274
Size: 26.2 x 35.2 x 3.2

Seasoning case



AG 491B
Size: 13.5 x 21 x 31.5



AG 492C
Size: 13.5 x 21 x 11

HOUSEWARES



AG 262
Size: Ø 23.5 x 12



AG 276
Size: 4.8 x 15.6 x 3.5



AG 409
Size: 18.3 x 16 x 12



AG 410
Size: 24.4 x 17.5 x 12



BABY POTTY

AG 359
Size: 30 x 33.2 x 30.2



HANGER & CLIPS



AG 204
Size: Ø 28 cms.
11 pcs.

AG 206
Size: 45 x 25.5
20 pcs.

AG 217
Size: Ø 37 cms.
13 pcs.



AG 270
Size: 38.5 x 21.5 x 0.5



AG 346
Size: 21.5 x 42.5



AG 350
Size: 30.5 x 17 x 0.5

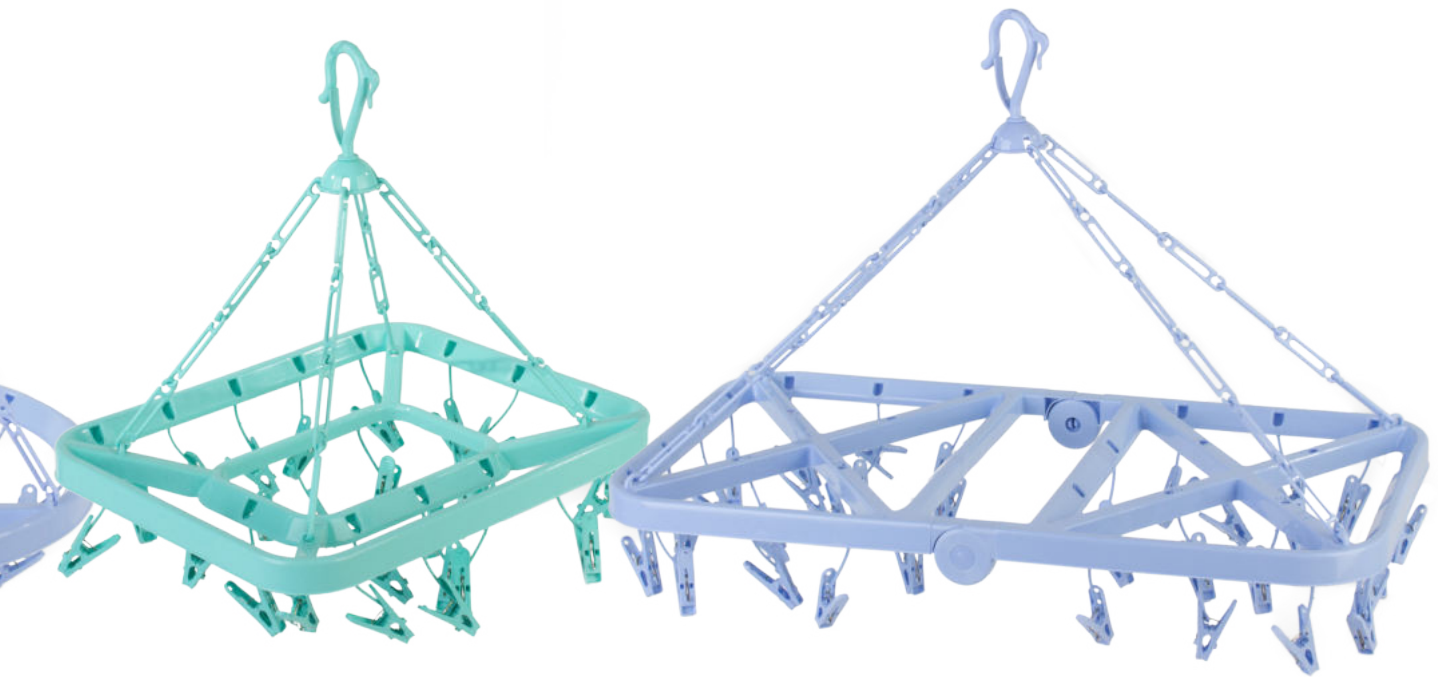

AG 218
Size: 31.5 x 38.5
 24 pcs.

AG 219
Size: 34 x 63
 32 pcs.

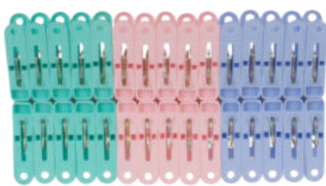

AM 012/18
Size: 10.8 x 12 x 2.6

AM 012/24
Size: 10.8 x 15.8 x 2.6

AM 012/30
Size: 10.8 x 19.5 x 2.6



AM 013/15
Size: 2 x 5

AM 013/18
Size: Ø 15.4 x 2.7

AM 013/24
Size: Ø 19 x 2.7

SOAP CASE



AG 1400
Size: 9.8 x 13.6 x 3.2



AG 256
Size: 8.2 x 11.5 x 5



AG 266
Size: 8 x 11.5 x 5.2



AG 309
Size: 8.2 x 12.8 x 5.2



STOOL



AG 999
Size: 22 x 29 x 16.5



BB 107
Size: 24 x 33.3 x 20.8

BB 108
Size: 27.4 x 35.2 x 27.7



BB 109
Size: 30.3 x 37.9 x 34

Color  

P ART CASE



without partition



F 120 A
Size: 12.7 x 9 x 3



F 155 HA
Size: 15.3 x 9 x 3



F 155 A
Size: 15.3 x 12.6 x 3



F 155 F
Size: 15.3 x 12.6 x 4.5



F 230 HA
Size: 22.6 x 12.6 x 3



F 230 HF
Size: 22.6 x 12.6 x 5



F 230 A
Size: 22.6 x 16.2 x 3



F 230 F
Size: 22.6 x 16.2 x 5

P ART CASE

with partition



PART CASE *with partition*



PS 120 A
Size: 12.7 x 9 x 3



PS 155 HA
Size: 15.3 x 9 x 3



PS 230 HA
Size: 22.6 x 12.6 x 3



PS 230 HF
Size: 22.6 x 12.6 x 5



PS 300 A
Size: 30 x 20 x 3



PS 300 F
Size: 30 x 20 x 5



PS 375 F
Size: 37 x 23.5 x 5



PS 155 A
Size: 15.3 x 12.6 x 3



PS 155 F
Size: 15.3 x 12.6 x 4.5



PS 230 A
Size: 22.6 x 16.2 x 3



PS 230 F
Size: 22.6 x 16.2 x 5

Basket

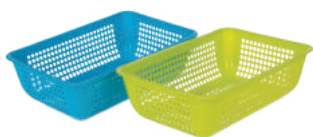

AG 201
Size: 14 x 21 x 10.6



AG 202
Size: 21 x 30 x 10



AG 325
Size: 19 x 24.5 x 13.5

AG 326
Size: 22 x 28 x 16



AG 306
Size: 21 x 22 x 9



AG 307
Size: 24.5 x 26 x 10



AG 308
Size: 28 x 30 x 11



AG 316
Size: 30 x 43 x 23

AG 288
Size: 34.5 x 47 x 21.5



AG 295
Size: 25 x 35.5 x 13
Cap: 8 Lts.



AG 296
Size: 30.5 x 44 x 15.2
Cap: 14 Lts.



AG 297
Size: 35.5 x 52.5 x 18
Cap: 23 Lts.



UTILITY RACK

AG 310
Size: 30 x 38.5 x 18.5

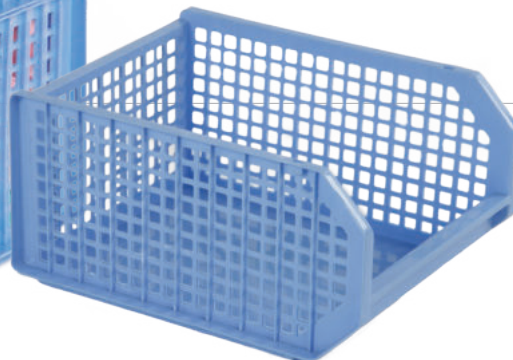

LAUNDRY BASKET



AG 293
Size: 30 x 34 x 34.5
Cap: 22 Lts.

AG 555
Size: 39.5 x 43 x 43.5
Cap: 47 Lts.

AG 294
Size: 35 x 38.5 x 40.5
Cap: 35 Lts.



AG 292
Size: 34 x 44.5 x 18
Cap: 16 Lts.



AG 291
Size: 39 x 52 x 21
Cap: 25 Lts.



AG 290
Size: 44.5 x 61 x 23.5
Cap: 37 Lts.

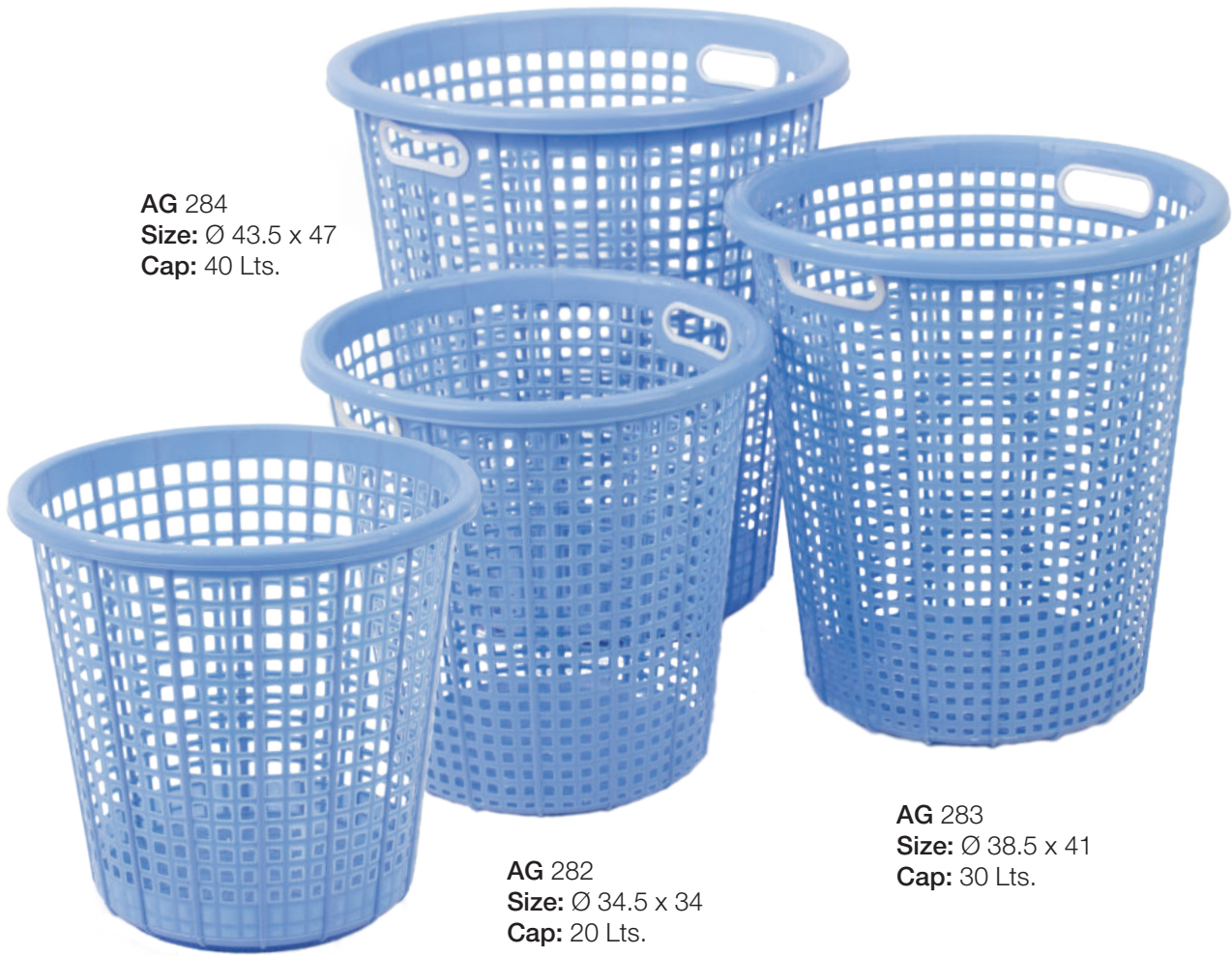
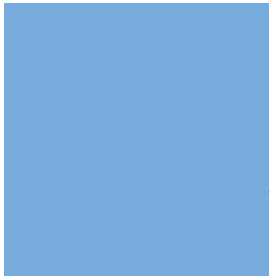

AG 284
Size: Ø 43.5 x 47
Cap: 40 Lts.

AG 282
Size: Ø 34.5 x 34
Cap: 20 Lts.

AG 283
Size: Ø 38.5 x 41
Cap: 30 Lts.

AG 281
Size: Ø 28.5 x 27
Cap: 10 Lts.



AG 227
Size: 31 x 43 x 16.5
Cap: 15 Lts.

AG 228
Size: 36.5 x 52 x 20
Cap: 25 Lts.

AG 229
Size: 43.5 x 58.5 x 22.5
Cap: 37 Lts.

Handy Basket



AG 432
Size: 52.5 x 68.5 x 32



AG 433
Size: 44.5 x 47.5 x 53

Large Laundry Basket



AG 345
Size: 34 x 42 x 59



AG 930
Size: Ø 28 x 11

AG 935
Size: Ø 33 x 13.5

AG 940
Size: Ø 38 x 15.5

BASIN



AG 18
Size: Ø 18 x 6.4



AG 20
Size: Ø 20 x 6.8



AG 50
Size: Ø 50 x 18.5



AG 65
Size: Ø 64 x 21



AG 278
Size: 14 x 25 x 10.2



AG 279
Size: 15.7 x 27 x 11.5



AG 280
Size: 15 x 27.7 x 14



AG 299
Size: 42 x 71 x 21.3

B

UCKET



AG 130 LB
Size: Ø 54.5 x 72
Cap: 30 Gals.



AG 102 L
Size: Ø 28 x 23
Cap: 2.5 Gals.



AG 103 L
Size: Ø 29.5 x 25.5
Cap: 3.5 Gals.



AG 104 L
Size: Ø 31.7 x 29
Cap: 4.5 Gals.



AG 105 L
Size: Ø 35 x 34
Cap: 5.5 Gals.



AG 106 L
Size: Ø 36 x 36
Cap: 6.5 Gals.



AG 108 L
Size: Ø 37 x 38.5
Cap: 8 Gals.

AG 110 L
Size: Ø 42.5 x 43.5
Cap: 10 Gals.

AG 130 L
Size: Ø 54.5 x 72.5
Cap: 30 Gals.

AG 140 L
Size: Ø 58.5 x 77.5
Cap: 40 Gals.



AG 341
Size: Ø 34 x 22
Cap: 12 Lts.

AG 342
Size: Ø 39 x 25
Cap: 20 Lts.

AG 343
Size: Ø 45 x 31
Cap: 35 Lts.

AG 344
Size: Ø 54.5 x 35
Cap: 58 Lts.



RECTANGULAR BUCKET

AG 399
Size: 23.5 x 40 x 22.6
Cap: 14 Lts.



COOLER BOX



AG 438
Size: 16 x 19.5 x 28
Cap: 2.2 Lts.



AG 398
Size: 21 x 21 x 24
Cap: 4 Lts.



AG 395
Size: Ø 21 x 21.5
Cap: 4 Lts.



AG 06
Size: 23 x 21.5 x 21.5
Cap: 4.5 Lts.



AG 07
Size: 31 x 18.2 x 19.5
Cap: 4.3 Lts.

AG 429
Size: 21 x 16.5 x 23
Cap: 2.5 Lts.



AG 430
Size: 29 x 22 x 31
Cap: 6 Lts.

AG 434
Size: Ø 25 x 35
Cap: 8 Lts.



AG 396
Size: Ø 21.5 x 28.5
Cap: 5 Lts.





FISHING COOLER BOX



AG 2515
Size: 47 x 28.5 x 29
Cap: 15 Lts.

AG 2520
Size: 52.5 x 31 x 29
Cap: 20 Lts.

AG 2532
Size: 56 x 35 x 34.5
Cap: 32 Lts.

SMART COOLER



AG 991
Size: 56.5 x 28 x 28
Cap: 18 Lts.



AG 993
Size: 70 x 33.5 x 31.5
Cap: 35 Lts.



AG 992
Size: 56.5 x 28 x 35.5
Cap: 25 Lts.



AG 994
Size: 70 x 33.5 x 46
Cap: 55 Lts.



COLORADO COOLER BOX

AG 550
Size: 75 x 38 x 38.5
Cap: 55 Lts.



AG 750
Size: 87.5 x 41.2 x 39
Cap: 75 Lts.



D

COOLER BOX

-SERIES



AG D5
Size: Ø 22 x 22.5
Cap: 4 Lts.



AG D4
Size: Ø 24.5 x 28.5
Cap: 5.5 Lts.



AG D3
Size: Ø 29 x 33.5
Cap: 9 Lts.



AG D2
Size: Ø 32 x 40.5
Cap: 17 Lts.



AG D1
Size: Ø 35 x 45.5
Cap: 21 Lts.



AG SUPER - D
Size: Ø 37 x 50
Cap: 27 Lts.



DOG HOUSE



AG 616
Size: 60 x 74.5 x 66



AG 619
Size: 73.5 x 98.5 x 80.5



OFFICE SUPPLIES

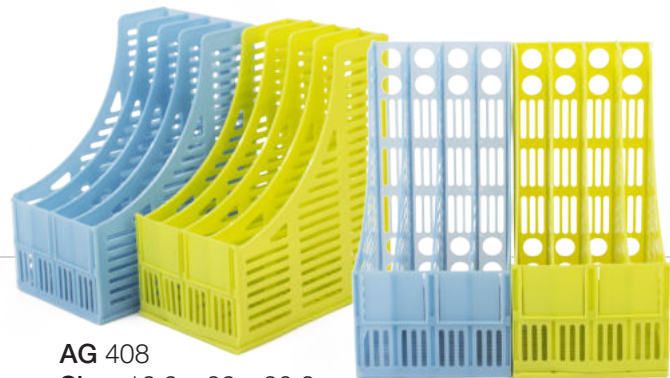

AG 408
Size: 16.2 x 26 x 30.3
Cap: 21 Lts.



AG 423
Size: 25.5 x 35 x 33.5



AG 407
Size: 25.5 x 35 x 33.5



AG 414
Size: 25.5 x 35 x 24.5



AG 405
Size: 25.5 x 35 x 24.5



AG 778
Size: 27 x 34.5 x 27.3



AG 742
Size: 27 x 34.5 x 27.3



AG 740
Size: 27 x 34.5 x 27.3



AG 440
Size: 38 x 27 x 5



AG 603
Size: 34.5 x 24.7 x 14



AG 805
Size: 27 x 34 x 25



AG 814
Size: 27 x 34 x 25



AG 807
Size: 27 x 34 x 34



AG 823
Size: 27 x 34 x 34

STACKABLE DOCUMENT TRAY



AG 5505
Size: 26 x 33.3 x 24.2

D

RAWER



AG 355/3
Size: 25.2 x 34 x 28.5



AG 355/4
Size: 25.2 x 34 x 37.5



AG 356/3
Size: 25.2 x 34 x 39.3



AG 356/4
Size: 25.2 x 34 x 52



AG 356/8
Size: 25.2 x 34 x 101.4

DRAWER



AG 456/3
Size: 34 x 41.5 x 66.2

AG 456/4
Size: 34 x 41.5 x 86.5

AG 456/5
Size: 34 x 41.5 x 112



AG 348/3
Size: 34.5 x 42 x 48



AG 349/4
Size: 42.5 x 72.5 x 80.2



AG 454/4
Size: 40 x 75.5 x 135.5



AG 515/5
Size: 32 x 44 x 88



AG 455/3
Size: 80 x 75.5 x 104



AG 465/4
Size: 71.5 x 74.3 x 72.5



AG 466/4
Size: 71.5 x 74.3 x 72.5

DUST BIN



AG 215
Size: Ø 20.5 x 22
Cap: 5 Lts.

AG 216
Size: Ø 23 x 27.5
Cap: 8 Lts.



AG 210
Size: 18 x 18 x 30
Cap: 4 Lts.



AG 211
Size: 21 x 21 x 34
Cap: 6 Lts.



AG 212
Size: 24 x 24 x 42
Cap: 12 Lts.

DUSTBIN WITH PEDAL



AG 298
Size: 36 x 24 x 32
Cap: 11 Lts.



AG 328
Size: 41 x 33 x 43
Cap: 30 Lts.



AG 329
Size: 41 x 33 x 57.5
Cap: 42 Lts.

S

HOE RACK



AG 351/4
Size: 26 x 38.4 x 61.5



AG 351/3
Size: 26 x 38.4 x 47



AG 352/3
Size: 51.3 x 38.4 x 47.8



AG 352/5
Size: 51.3 x 38.4 x 76

S

TORAGE BOX



AG 1007
Size: 19.5 x 33.7 x 18.5
Cap: 7 Lts.



AG 1012
Size: 29.5x 44.5 x 15.5
Cap: 12 Lts.



AG 1024
Size: 30.5 x 47 x25.6
Cap: 24 Lts.



AG 335
Size: 33 x 44 x 26.6
Cap: 21 Lts.



AG 1053
Size: 58 x 40 x 32.5
Cap: 55 Lts.



AG 1094
Size: 46 x 66 x 41
Cap: 90 Lts.



COLOR  



AG 424 w
Size: 62 x 47.5 x 39
Cap: 58 Lts.



AG 428
Size: 80 x 45 x 53
Cap: 130 Lts.

AG 428 w
Size: 80 x 45 x 56
Cap: 130 Lts.

CLEAN & CLEAR BOX



AG 1050
Size: 73.5 x 41 x 23
Cap: 50 Lts.



AG 1075
Size: 73.5 x 41 x 33
Cap: 75 Lts.



AG 1100
Size: 73.5 x 41 x 39.5
Cap: 100 Lts.



AG 1028
Size: 30.5 x 46.5 x 24.5
Cap: 28 Lts.



AG 1048
Size: 38 x 55 x 28
Cap: 48 Lts.



AG 1049
Size: 42 x 70.5 x 21
Cap: 49 Lts.



CONTAINER



AG 493
Size: 35 x 48 x 25.5



AG 111
Size: 39 x 59 x 31.5



AG 112
Size: 38.5 x 58 x 31



S

TOPPER



AG 3B - 221
Size: 29.5 x 20.3 x 25



AG 4A - 331
Size: 29.5 x 20 x 23



AG 1310
Size: 29.5 x 20 x 28



AG 2005
Size: 29.5 x 20 x 51



AG 1228
Size: 29.5 x 20 x 51



AG 2018
Size: 29.5 x 20 x 63.5

MISCELLANEOUS



AG 15
Size: 11 x 31.5 x 21.5



AG 161
Size: 18 x 18 x 15



AG 162
Size: 16.5 x 36 x 13.5



AG 163
Size: 5.5 x 60.5 x 39

AG 164
Size: 5.5 x 60.5 x 48



AG 501
Size: 6 x 13.2 x 2.2



AG 502
Size: 19.5 x 26.4 x 10.1

AG 503
Size: 24.8 x 24.8 x 1.5

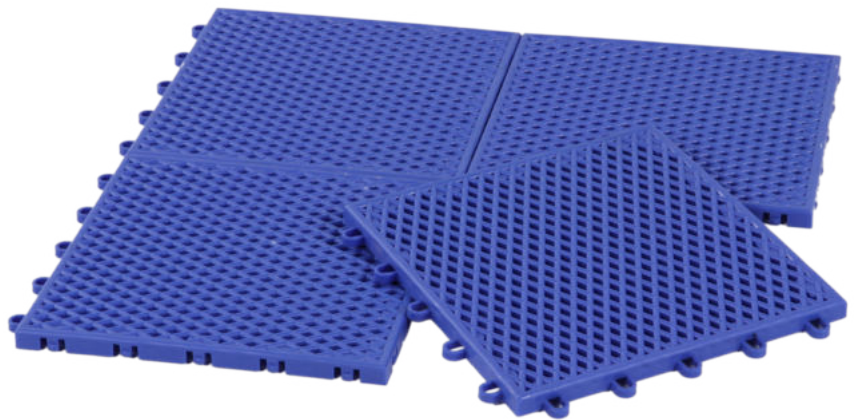

AG 626
Size: 37 x 56 x 41.5



GOLDEN CUP
WELL WARE



TRANSPARENT WASTE BIN WITH SWING LID 56 L

ถังขยะใสห้าเหลี่ยม ขนาด 56 ลิตร รุ่น AG3256
สะดวกต่อการใช้งานและการจัดเก็บ เคลื่อนย้าย



GOLDEN CUP
WELL WARE



**TRANSPARENT WASTE BIN
WITH SWING LID 56 L**



GOLDEN CUP
WELL WARE

AVAILABLE COLORS



W 28 x L 43 x H 84 cm
TRANSPARENT WASTE BIN
WITH SWING LID 56 L
AG3256SL



GOLDEN CUP
WELL WARE

ผลิตจาก โพลีโพรพิลีน (PP)



ใช้ถุงขยะขนาด 30x40

ผลิตจาก พอลิสไตรีน แบบใส (PS)

TRANSPARENT WASTE BIN 56 L

ทนแรงกระแทก และรอยขีดข่วนได้ดี
เพื่อความสะอาดและเป็นระเบียบเรียบร้อย
ใช้งานง่ายไม่ต้องเปิดฝา



GOLDEN CUP
WELL WARE

AVAILABLE COLORS



W 28 x L 43 x H 61 cm

TRANSPARENT WASTE BIN 56 L



DUST BIN WITH PEDAL 11 L

ถังขยะเหยียบ ดีไซน์รูปทรงกะทัดรัด ขนาด 11 ลิตร
สามารถวางเข้ามุมได้ ช่วยให้ประหยัดพื้นที่ในการวาง
มีขาเหยียบ ใช้งานสะดวก



GOLDEN CUP
WELL WARE

AVAILABLE COLORS



W 36 x L 24 x H 32 cm
DUST BIN WITH PEDAL 11 L
AG298



GOLDEN CUP
WELL WARE



DUST BIN WITH PEDAL 30 L

ถังขยะเหยียบ ดีไซน์รูปทรงกะทัดรัด ขนาด 30 ลิตร
สามารถวางเข้ามุมได้ ช่วยให้ประหยัดพื้นที่ในการวาง
มีขาเหยียบ ใช้งานสะดวก



GOLDEN CUP
WELL WARE

AVAILABLE COLORS



W 31 x L 33 x H 43 cm
DUST BIN WITH PEDAL 30 L
AG328



GOLDEN CUP

WELL WARE



DUST BIN WITH PEDAL 42 L

ถังขยะเหยียบ ดีไซน์รูปทรงกะทัดรัด ขนาด 42 ลิตร
สามารถวางเข้ามุมได้ ช่วยให้ประหยัดพื้นที่ในการวาง
มีขาเหยียบ ใช้งานสะดวก



GOLDEN CUP
WELL WARE

AVAILABLE COLORS



W 41 x L 33 x H 57.5 cm
DUST BIN WITH PEDAL 42 L
AG329



GOLDEN CUP
WELL WARE



DUST BIN WITH SWING

ถังขยะฝาสวิง ผลิตจากพลาสติกคุณภาพดี
ทนทานต่อการใช้งานวางเข้ามุมได้อย่างเป็นระเบียบ
ใช้งานสะดวกด้วยฝาเปิด-ปิดแบบสวิง



GOLDEN CUP
WELL WARE



W 18 x L 18 x H 30 cm
DUST BIN WITH SWING
AG210



W 21 x L 21 x H 34 cm
DUST BIN WITH SWING
AG211



W 24 x L 24 x H 42 cm
DUST BIN WITH SWING
AG212



GOLDEN CUP
WELL WARE



DUST BIN

ถังขยะกลม ผลิตจากพลาสติกคุณภาพดี
ขนาดกะทัดรัด ตัวถังขยะมีพื้นผิวเรียบ
ง่ายต่อการล้างทำความสะอาด



GOLDEN CUP

WELL WARE



Ø 20.5 x H 22 cm

DUST BIN 5 L

AG215



Ø 23 x H 27.5 cm

DUST BIN 8 L

AG216



**EVEREST
COOLER
BOX**

LUG™ 54_L





DIMENSIONS LUG™ 54

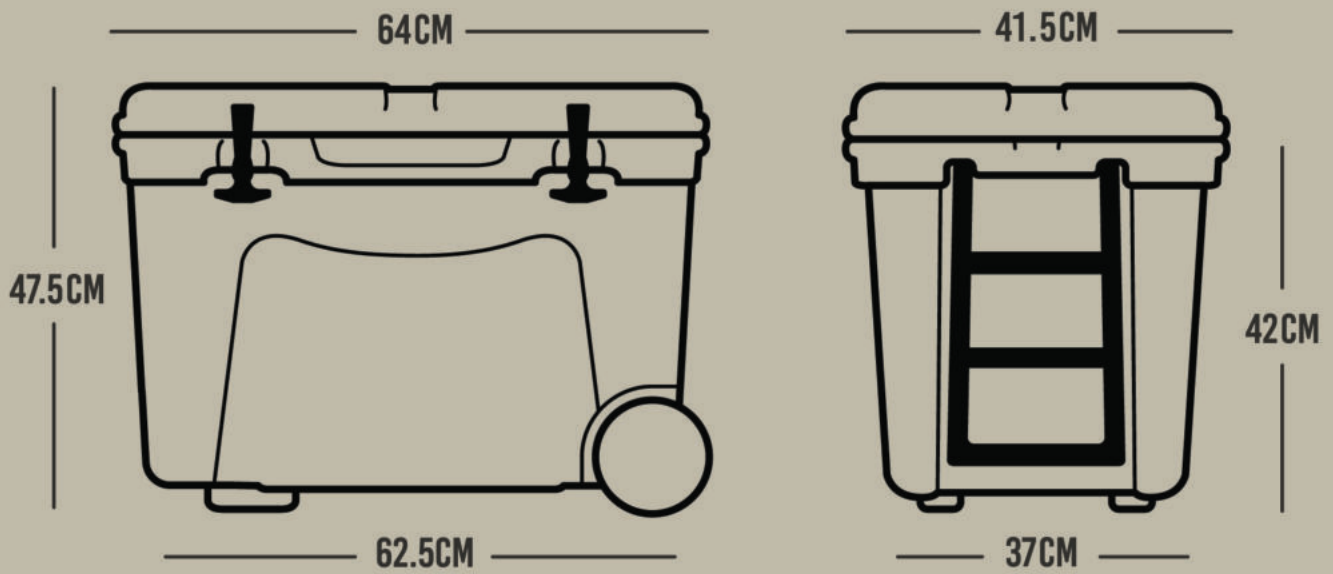

SIZE : W41.5 x L64 x H47.5 CM.





**EVEREST
COOLER
BOX**

LUGTM 54_L





**EVEREST
COOLER
BOX**

FEATURES **LUG™ 54_L**



Keeps Ice Up To 48-72 hrs.



Up to 2" Insulated walls



Heavy Duty Rubber Latches



Durable Handle & Wheels



No Sweat Exterior



Easy-Flow Drain Plug



Lockable Lid



PP



BPA FREE



ANTIBACTERIAL



LUG™ 54L

FUNCTION



320ml



600ml



1000ml



1500ml



รูระบายน้ำ



ล้อลาก



หูลาก



ยางล้อคกระดิก



ฟ้ามียขอบยาง EVA FOAM ช่วยเก็บความเย็น





**EVEREST
COOLER
BOX**

COLOR





**EVEREST
COOLER
BOX**



9L

**AG
2509**



PP



BPA FREE



ANTIBACTERIAL

ผลิตจาก โพลีโพรพิลีน (PP) ผสมสาร Antibacteria ช่วยป้องกันการเจริญเติบโตของแบคทีเรีย



**EVEREST
COOLER
BOX**

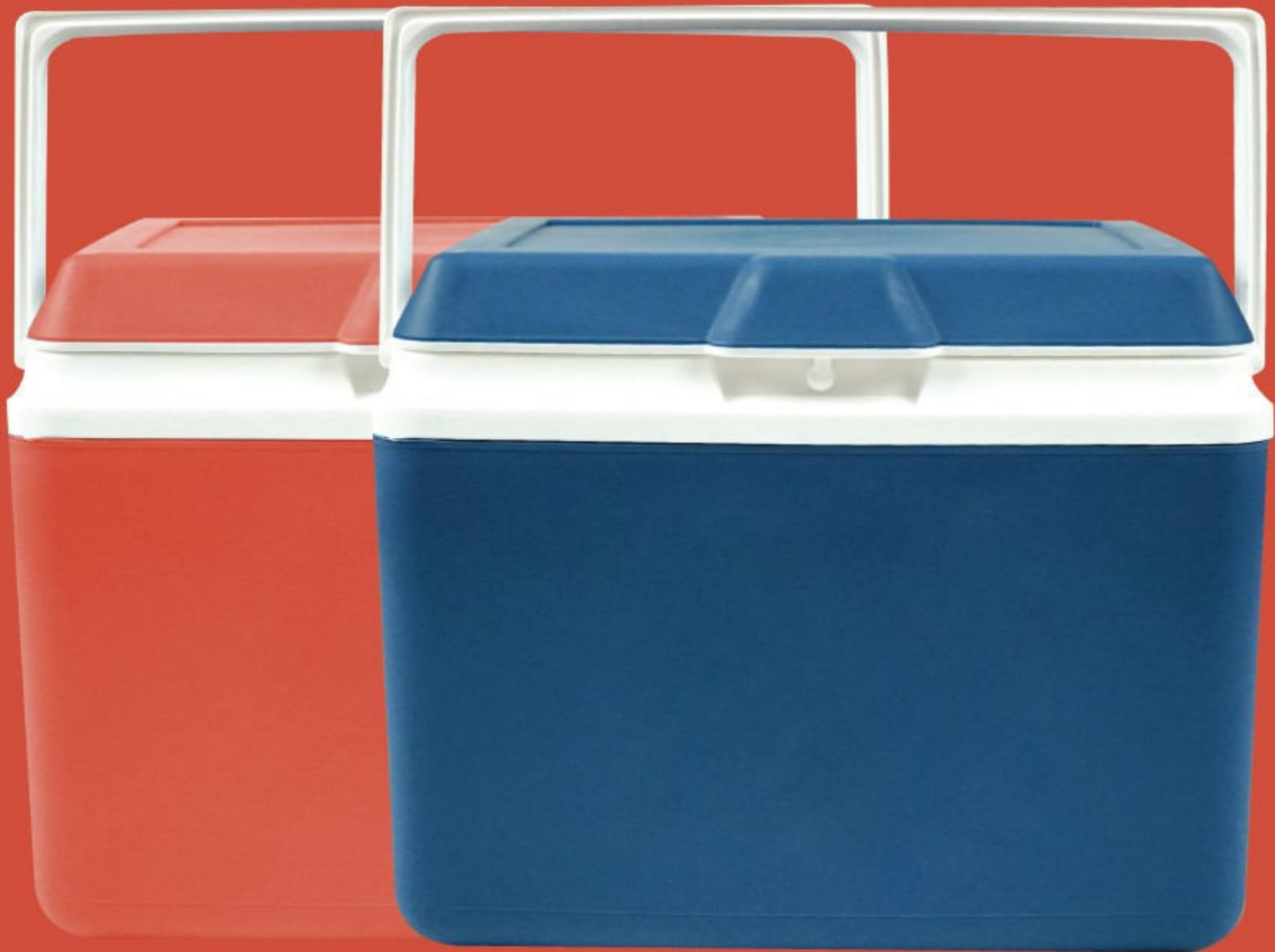

กระติกน้ำแข็ง ถังแช่เนกประสงค์ 9 ลิตร
ทนทาน ใช้งานได้นาน

สามารถเก็บความเย็นได้อย่างดีเยี่ยม 10-15 ชม.
ฝาเปิดปิดสะดวก



21 X 32 X 26.5 CM



EVEREST
COOLER
BOX

FUNCTION



ที่บล๊อค



หูหิ้วแข็งแรง



ขนาดกระทัดรัด



320ml



600ml



1000ml

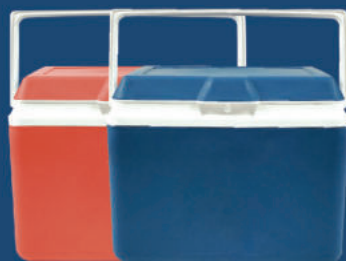



**EVEREST
COOLER
BOX**



59 L
WITH TABLE
AG994T

35 L
WITH TABLE
AG993T



PP



BPA FREE



ANTIBACTERIAL

เก็บความเย็นได้นานสูงสุด
12-15 hrs.





59 L
WITH TABLE
AG994T



1500ml



1000ml



600ml



320ml

หมายเหตุ : จำนวนความจุอ้างอิงขึ้นอยู่กับวิธีการจัดวาง

W32 x L65 x H46 CM

35 L
WITH TABLE
AG993T



320ml



600ml



1000ml



1500ml

หมายเหตุ : จำนวนความจุอ้างอิงขึ้นอยู่กับวิธีการจัดวาง

W32 x L65 x H32 CM



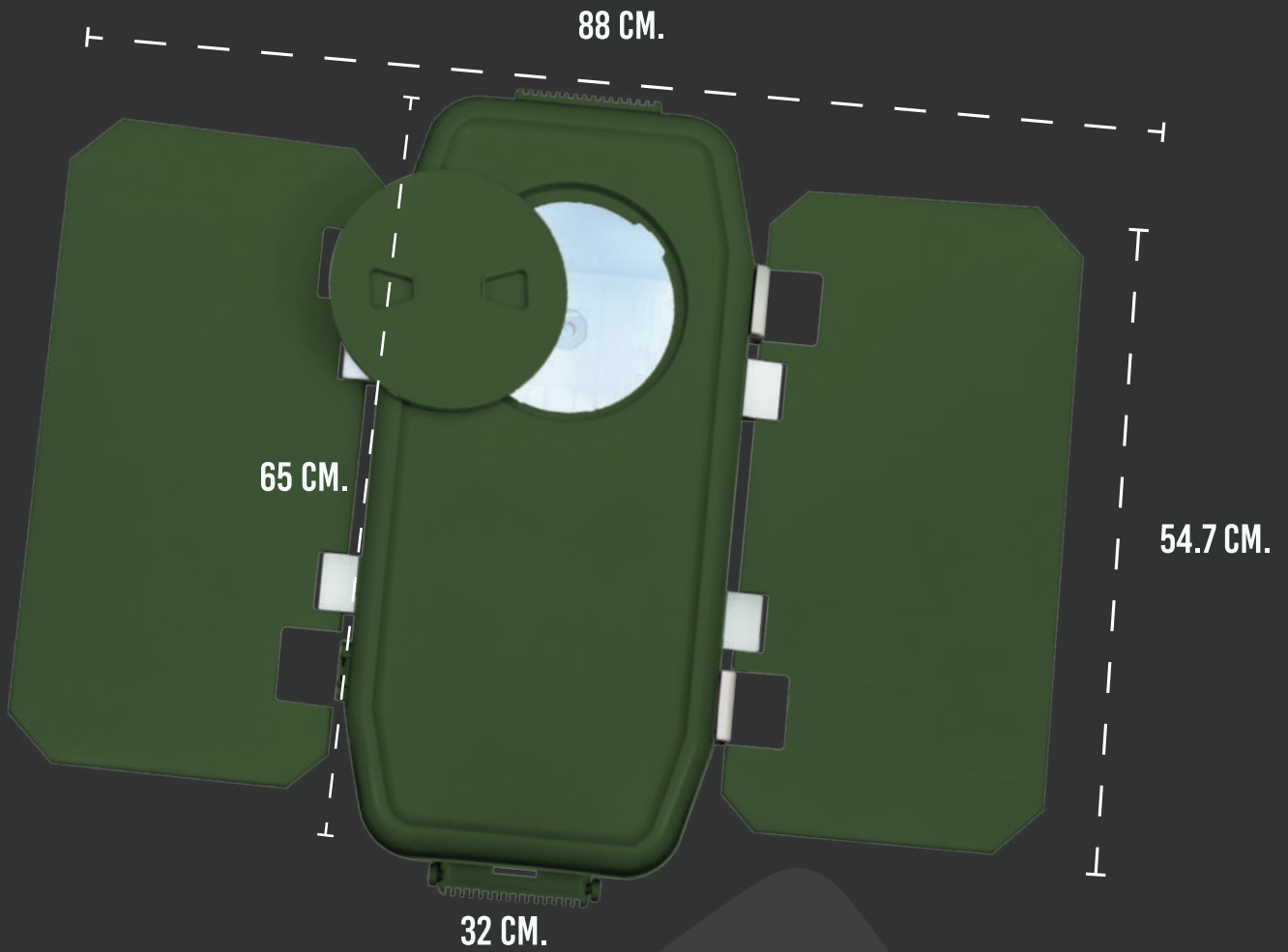

- Long Lasting Ice Retention
- Durable
- Food Grade Material

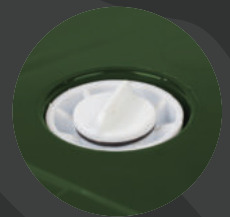

PHITHAKSAKORN (A.E.C. 2015) CO., Ltd.
23/8-9 Soi Ekachai 66 Yak 1, Ekachai Rd.,
Bangbon, Bangkok 10150, Thailand

 www.phithaksakom.co.th

 : vithawin.c@phithaksakornaec.com

PHITHAKSAKORN (A.E.C. 2015) CO., Ltd.
23/8-9 Soi Ekachai 66 Yak 1, Ekachai Rd.,
Bangbon, Bangkok 10150, Thailand

 www.phithaksakom.co.th

 : vithawin.c@phithaksakornaec.com