

# User Manual of Smart Bird Feeder

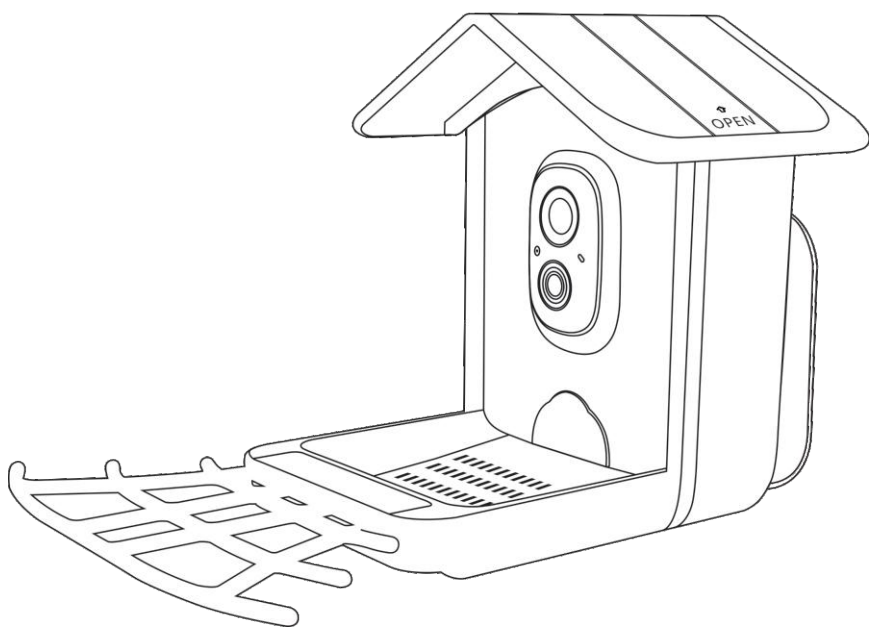

FCC ID: 2A50S-G02

# Warranty Service

Thanks for your shopping and trust.

We have been optimizing our products and improve our lifetime customer service to offer you a better shopping experience.

If you have any problems, please feel free to write us e-mail We will solve your problems within 24 hours. In addition, your advice or suggestions will be much appreciated and welcomed.

Register via link below to get 3 Years Warranty Extension.  
(or scan this QR code)

<https://bit.ly/3zBSB2y>



## Product Service

Email: [support@dzees.com](mailto:support@dzees.com)

Distributor: [distributor@dzees.com](mailto:distributor@dzees.com)

Tel: +1 (978)3092799 (Mon-Fri 9:00 AM-5:00 PM EST)

## More About Us

Web: [www.dzees.com](http://www.dzees.com)

Facebook: [www.facebook.com/DzeesHome](https://www.facebook.com/DzeesHome)

## **FCC Warning**

This equipment has been tested and found to comply with the limits for a Class B digital device, pursuant to Part 15 of the FCC Rules. These limits are designed to provide reasonable protection against harmful interference when the equipment is operated in a commercial environment. This equipment generates uses and can radiate radio frequency energy and, if not installed and used in accordance with the instructions, may cause harmful interference to radio communications.

The antennas used for this transmitter must be installed to provide a separation distance of at least 20 cm from all persons and must not be co-located for operating in conjunction with any other antenna or transmitter.

FCC (USA) 15.9 prohibition against eavesdropping except for the operations of law enforcement officers conducted under lawful authority, no person shall use, either directly or indirectly, a device operated pursuant to the provision of this part for the purpose of overhearing or recording the private conversations of other unless such use is authorized by all of the parties engaging in the conversation.

# Catalog

Contents .....	01
Product Diagram .....	03
How to Assemble Smart Bird Feeder .....	04
How to Set up the Camera .....	07
Installation .....	25
How to Add Bird Seed .....	37
Cleaning and Maintenance .....	39
How to Do Bird AI Recognition .....	40
FAQ .....	42

# Contents

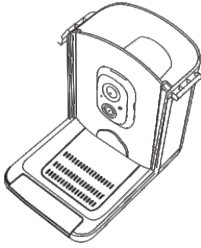

**Bird Seed Container\*1**  
(Camera and Bird Seed  
Outlet Valve include)



**Feeder Cover \*1**

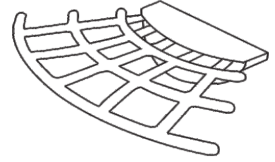

**Bird Perch\*1**



**Mounting Bracket\*1**



**Bracket Screws\*2**



**Bracket Screwdriver\*1**



**3W Solar Panel\*1**

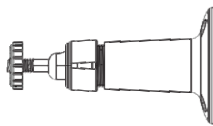

 X 3

**Solar bracket screws\*3**  
**Solar Panel Kit \*1**

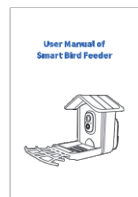

**Manual\*1**

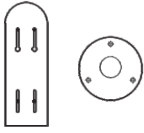

Drilling Template Sticker \*1  
Solar Bracket Positioning Sticker \*1



Bracket Screws\*4



Anchors\*4

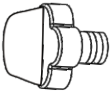

Thumb Screws\* 3

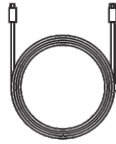

Type-C Power Cable\* 1  
Micro USB data cable\*1



External Antenna\*1

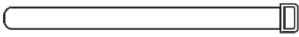

Strap\*1



Fruit Holder\*4



Ejector Pin\*1

# Product Diagram

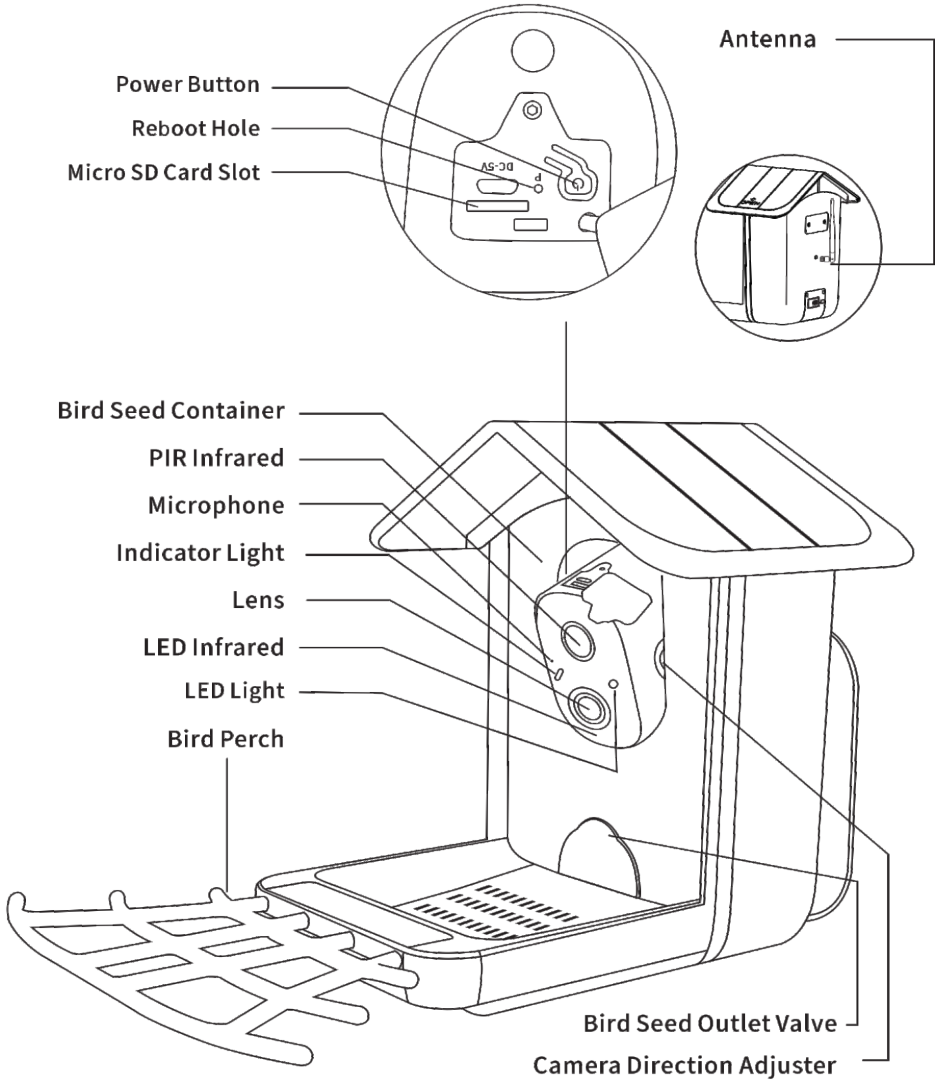

# How to Assemble Smart Bird Feeder

## 1. Assemble the base

**Step 1.** Insert the antenna into the hole in the middle of the back of the bird seed container and twist it tight.

**Note:** If the antenna is disconnected or not attached properly, the app will not be able to connect to the smart bird feeder.

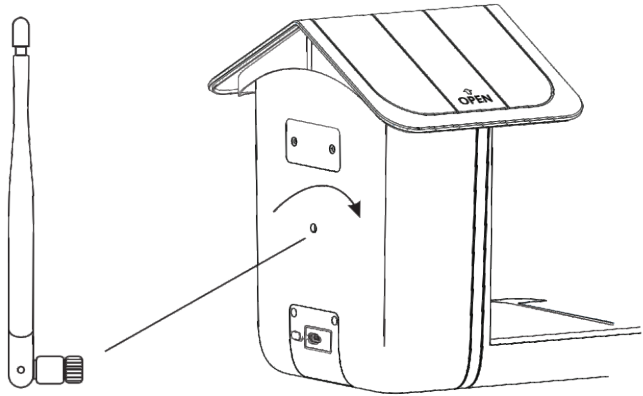

## 2. Assemble Feeder Cover

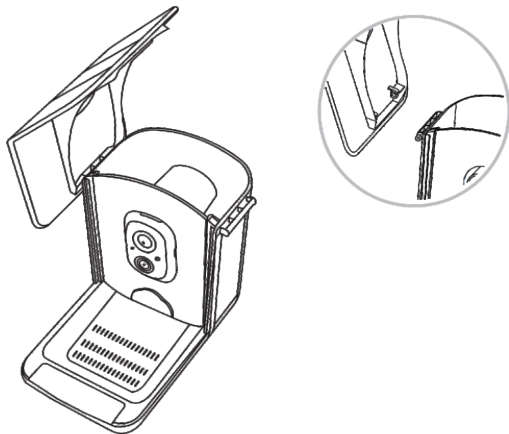



**Step 1.** Align the feeder cover with the roof of the bird seed container and gently put it down, then fasten the buckle on the right side of the cover to the bird seed container. You will hear a clicking sound which indicates that the cover is securely mounted.

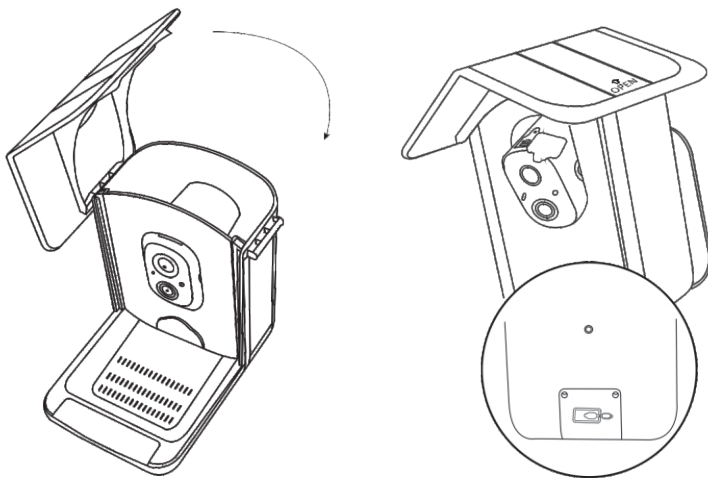

### 3. Assemble the Bird Perch

**Step 1.** Install the bird perch at the front of the base.

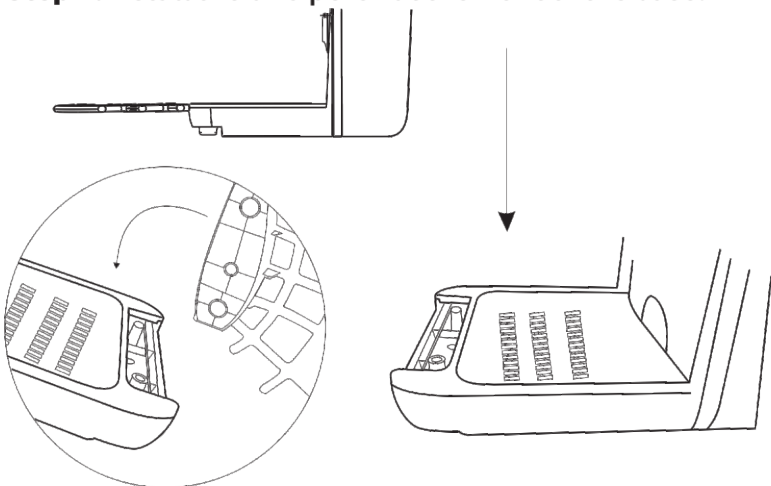

**Step 2.** Use one of the provided thumb screws to secure the bird perch

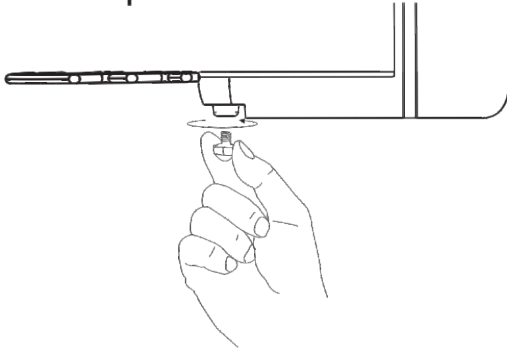

#### 4. Insert Micro SD Card into Camera

**Note:** The SD card is not included, and it is not necessary. You can use the feeder without it.

Birdkiss camera comes with a built-in card slot that supports up to 128GB MicroSD card. Insert the card into the camera before you assemble the whole unit.

**Step 1:** Gently rotate the camera down to the bottom.

**step 2:** Open the top silicone plug. Insert the MicroSD card. Make sure to insert it in the right direction.

**Step 3:** Finally, cover the silicone plug.

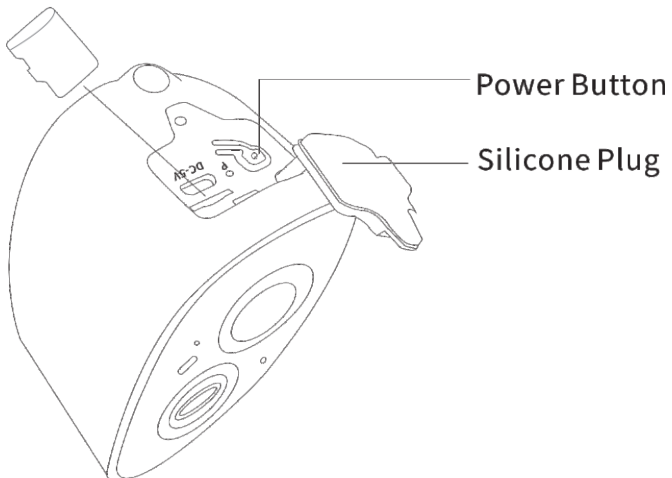

# How to Set up the Camera

## 1. How To Turn On & Off The Camera

	Operation	Status
Turn On the Camera	Long press the power button for 3s	Startup sound Light: Solid Blue
Turn Off the Camera	Long press the power button for 3s	Shutdown sound Light: Off
Enter the Network Configuration Mode	Double click the power button	Sound: Ding Dong Ding Dong Light: Solid Blue

**Note:** The reboot hole is used to restart the camera without changing the settings. You can insert the included ejector pin into the reboot hole, then press and hold to reboot.

## 2. Indicator Light Status

Mode	Status
Working mode	Blue
Sleep Mode	Off
Charging mode	Yellow
Fully charged mode	Green

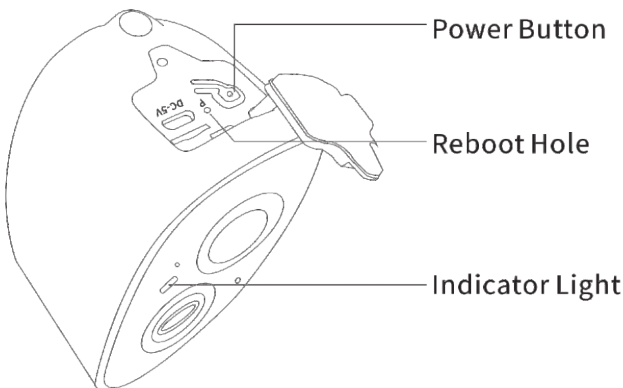

### 3.Camera Specifications

Item	Specification
MODEL	G02
Camera Lens	M12,f:3.3mm, F2.0, 200W
Viewing Angle	Vertical: 85° Diagonal: 160° Horizontal: 110°
Minimum Illumination	0.01Lux
Video Compression Method	H.264
Lighting Frequency	50Hz, 60Hz
Image Frame Rate	15fps
Image Resolution	Max. 1920 X 1080P
Infrared Night Vision Distance	22.97ft
Video Bit Rate	Adaptive
Wi-Fi	2.4 GHz WiFi
Supporting Agreement	TCP/IP、UDP/IP、DHCP、 TMP、MUTP

Item	Specification
Storage Media	Micro SD card (up to 128GB, not include)
Battery Capacity	5000mAh
Standby Time	1 Year
Charging Voltage	DV 5V+-5% 1.5A
Charging Time	8~10 hours
Waterproof Level	IP65
Shutdown Power Consumption	0.32mW
Standby Power Consumption	1.68mW
Working Power Consumption during the Day	0.88W
Working Temperature	-10°~45°C
Storage Environment	-20°~60°C
Certificate	CE, FCC, RoHs, WEEE, MSDS, UN38.3, UL62368, BattG

## 4. Download and Install the VicoHome App

4.1. Scan the QR code below or search "VicoHome" on APP Store or Google Play Store to download and install the app.

4.2. Open the link to download and install

the App: <https://www.vicohome.io/download/>



## 5. Sign up

**Note:** The most up-to-date information can be found through the APP.

5.1. Open the app and input your username, country, email address. Check and agree to the User Agreement, then click 'Next Step'. (For a better experience, allow all permissions to avoid missing any notifications.)

### Sign up

Please enter your e-mail and we will send a verification code.

**Username**  
Bridkiss

**Country/Region**  
United States >

**E-mail**  
[Redacted]

I understand and agree User Agreement and Privacy Policy

Next Step

**5.2.** You will get an email with a verification code for account confirmation. Enter the code and click ‘Next Step’.

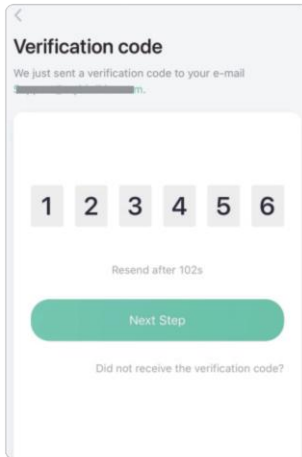

A mobile app screen titled "Verification code". At the top, it says "We just sent a verification code to your e-mail" followed by a redacted email address. Below this is a row of six input boxes, each containing a digit from 1 to 6. Underneath the boxes, it says "Resend after 102s". At the bottom, there is a green rounded button labeled "Next Step" and a link that says "Did not receive the verification code?".

**5.3.** Set the login password and reenter it to confirm. Click ‘Next Step’. (For account safety, the password needs to be a combination of at least 8 characters of uppercase and lowercase letters.)

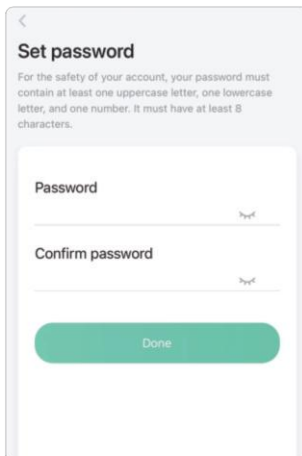

A mobile app screen titled "Set password". It includes a warning: "For the safety of your account, your password must contain at least one uppercase letter, one lowercase letter, and one number. It must have at least 8 characters." Below the warning are two input fields: "Password" and "Confirm password", each with a toggle for visibility. At the bottom, there is a green rounded button labeled "Done".

## 6.Add the Camera

**Note:** The most up-to-date information can be found through the app.

**6.1.**Click "Add a new device now"on the VicoHome App.

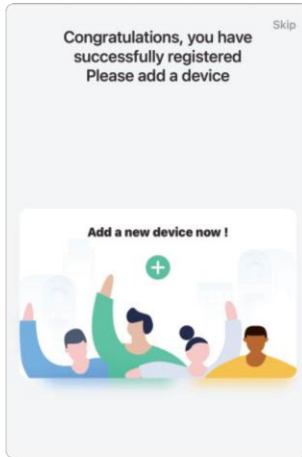

**6.2.**Follow the instructions on the app to turn on the camera: Long press the power button of the camera for 3s to turn on the camera. Then the indicator light in the front of the camera will be solid blue. Double click the power button to enter network configuration mode after the prompt tone.

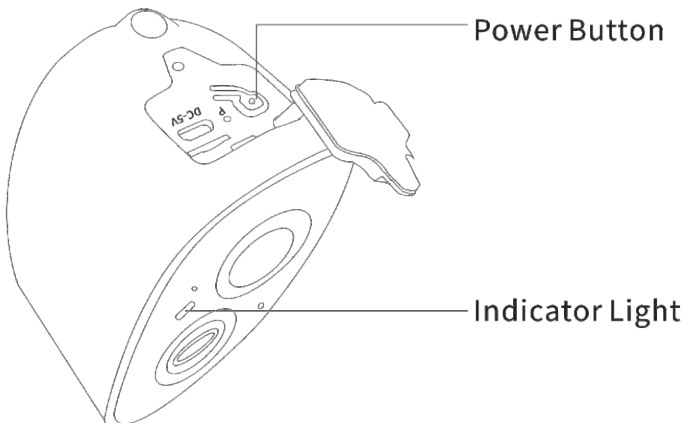



**6.3.** Listen for the ‘ding dong ding dong’ sound. After hearing the sound, click ‘I heard the sound or saw the light on’ in the app. Then, click ‘Next Step’.

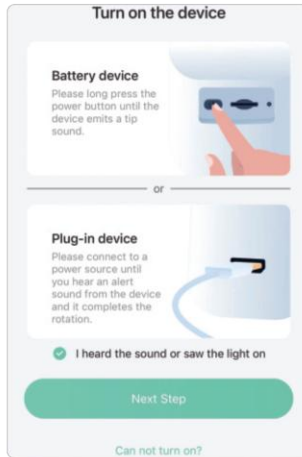

**6.4.** For quick connection, please follow the instructions to open the Bluetooth settings.

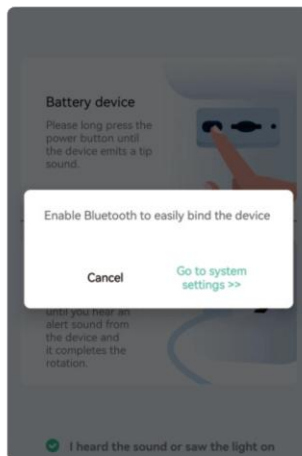

**6.5.**At this point, the phone enters the state of searching for smart bird feeder.

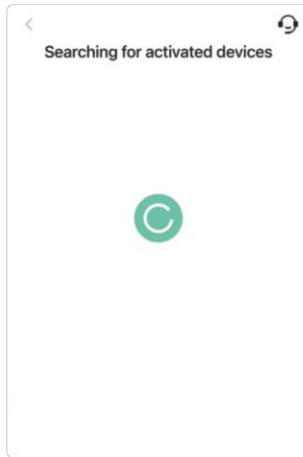

**6.6.**After hearing 'ding dong ding dong', check 'I heard the beeping sound' and click 'Next Step'.

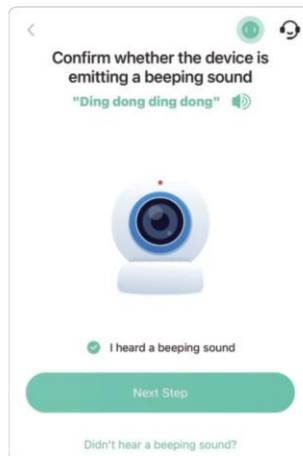

## 6.7. Select the smart bird feeder you need to connect.

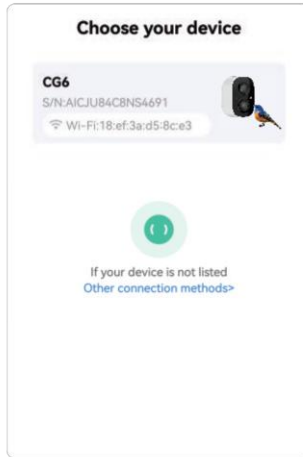

**6.8.** Enter the WiFi name and WiFi password you want to connect to, check 'Remember the Wi-Fi name and password after successful connection', and click 'Next Step'.

**Note:** The smart bird feeder only supports 2.4 GHz Wi-Fi networks with strong wall penetration capability.

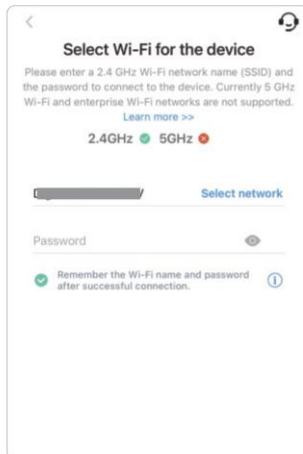

## 6.9. Confirm the Wi-Fi name and password.

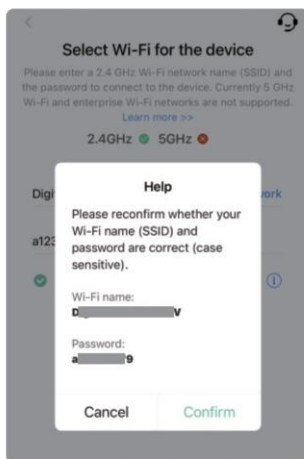

## 6.10. Click 'Connect'.

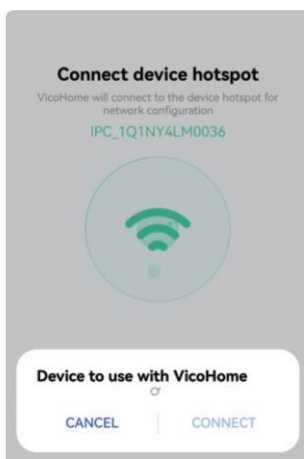

**Note:** If the smart bird feeder cannot be located by Bluetooth, a QR code will appear. Point the QR code at the lens of the camera to connect.



**6.11.** When connecting, please wait patiently for 15 seconds, then you will hear a sound ‘Wi-Fi Connected’ .

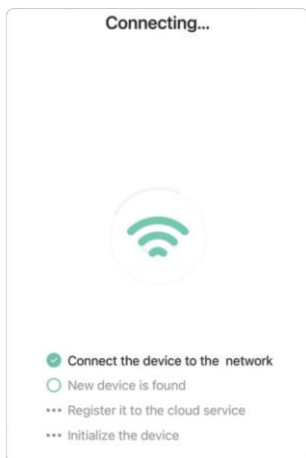

## 6.12. Set a name and location for smart bird feeder.

Device Name

Smart Bird Feeder

Location Edit

Front door Living room Back door

Garden Office Garage

+

Next Step

## 6.13. Finally, you will be informed of the current Wi-Fi network status. When the signal is weak, adjust the router or bird feeder position.

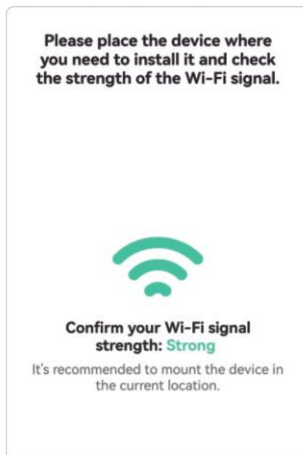

**6.14.** When you finish connecting, a message will appear about getting free cloud storage for 30 days. After 30 days, you can subscribe to a cloud storage package that suits you.

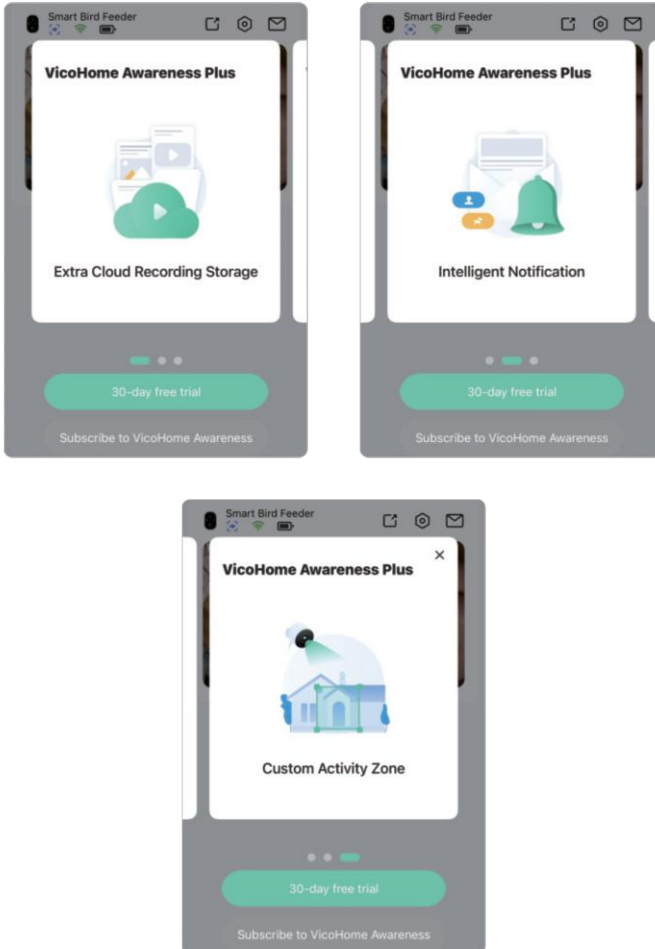

## **7. Possible problems with connecting:**

**7.1.**When you hear ‘Wi-Fi Password Error’ , please check whether the Wi-Fi password you entered in the app is correct.

**7.2.**When you hear ‘Authentication error’ , please ensure that your Wi-Fi network is not an enterprise-level Network. The device supports only networks with security below WPA-2.

**7.3.**When you hear ‘Wi-Fi not found’ , please check that you selected the correct Wi-Fi name. Place the device near the Wi-Fi router and ensure that the router is powered on. Please note that 5Ghz Wi-Fi cannot be located by the device.

**7.4.**When you hear ‘Retrieving IP timeout’ , it indicates that the number of devices connected to the router has reached the maximum. Please remove some of the connected devices that are not commonly used or restart the router to clear the unconnected devices. You may even need to contact the router administrator.

**7.5.**If you hear ‘Cloud service connection fail’ , it could be caused by network disconnection. Please ensure that the network connection is normal and try to temporarily turn off the firewall.



## 8. Share the camera

You can use this feature when you need to use the camera with other family members or friends. Only the admin user who has bound the camera for the first time can share and set up the camera, while other members can only view the live video or video playback feature of the camera.

**8.1.** For the admin user of the camera, find the camera you wish to share on the app homepage or camera settings screen, then click the share button and enter the share page. Click "Device Sharing" to generate a shared QR code.

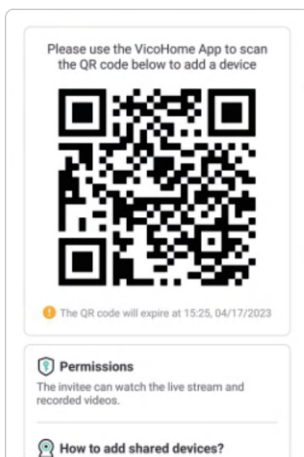
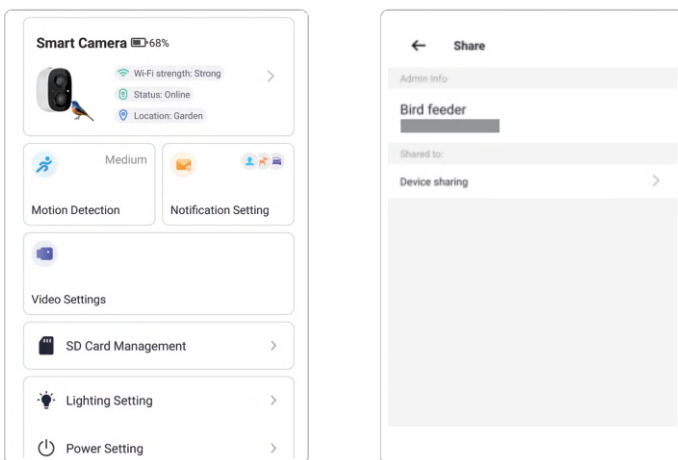

**8.2.** For users who need to be shared with, click "+" on the homepage and select "Add Friend's Device" to enter the scan code page.

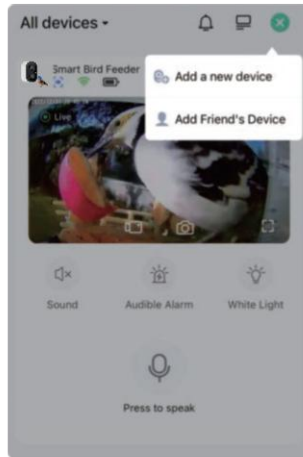

**8.3.** After the shared user successfully scans the QR code on the admin user's mobile phone, the admin user will receive a confirmation notification, then click "Accept" to complete the camera sharing.

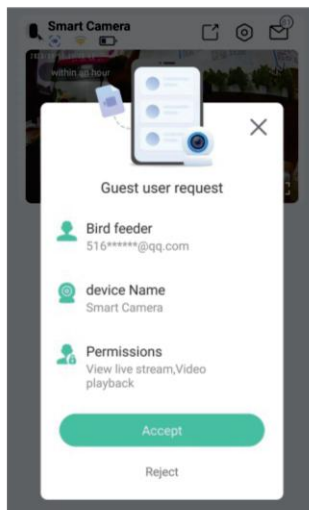

## 9. How to delete the shared smart bird feeder

If you want to delete shared friend devices, please go to the sharing page and select the friend account you want to delete. Swipe left and click the delete button.

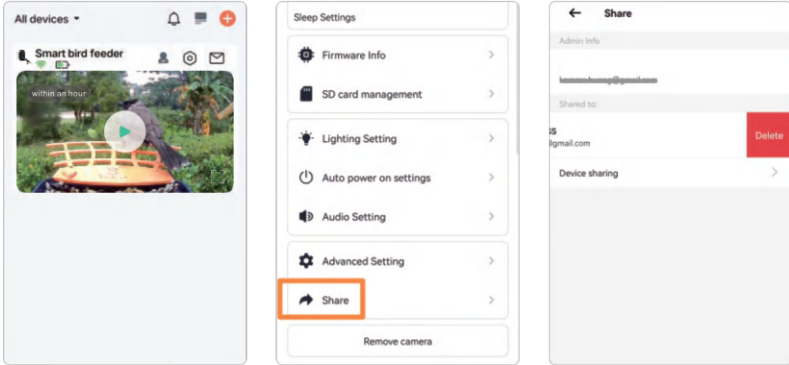

## 10. How to Charge the smart bird feeder

### 10.1. Check Battery Level

After setting up the camera, please check the battery level of the camera to make sure it is fully charged before installing it in the yard. The app will also remind you to charge your smart bird feeder when the battery is low.

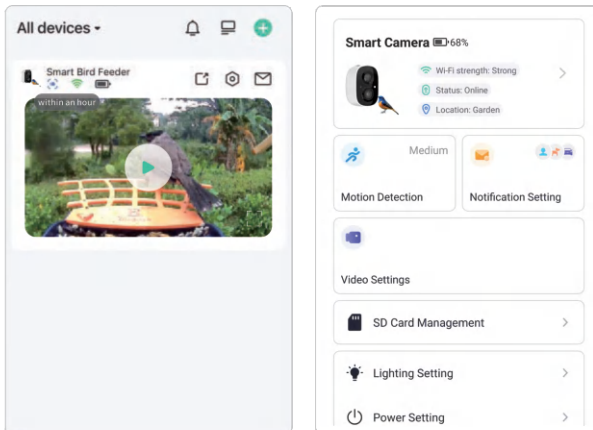

## 10.2. Charge the smart bird feeder

There are two ways to charge it.

### 10.2.1. Indoor Charging:

If you need to charge after installation, please don't move the camera and the base, just remove the birdseed container. The charging port is in the middle of the right side of the bird seed container. Please use the Type-C cable to plug into the 5V/1.5A charging adapter to charge the Birdkiss smart bird feeder.

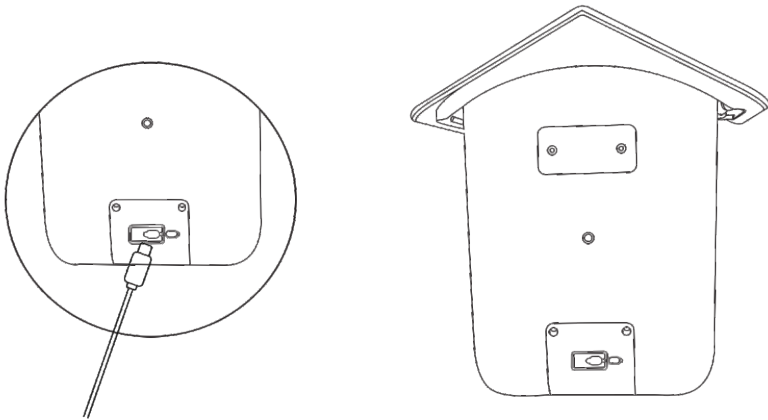

### 10.2.2. Outdoor charging:

You can directly use the equipped solar panel to connect to the charging port in the middle of the right side of the bird seed container.

**Note:** During charging, the camera's indicator light is solid yellow, and when the camera is fully charged, the indicator light will turn solid green. It will take ten hours to fully charge the camera.

# Installation

## 1. Before Installation

**1.1.** Keep Smart bird feeder Feeder and all accessories out of reach of children and pets.

**1.2.** Make sure the camera has been fully charged (DC5V / 1.5A).

**1.3.** Working temperature: -10°C to 45°C (14°F to 113°F)  
Working relative humidity: 0-95%

**1.4.** Please do not expose the camera lens to direct sunlight.

**1.5.** The camera has an IP65 waterproofing, which supports working properly under rains or snows. But it can not be soaked in water.

### Note:

**1.1.** Smart bird feeder only works with 2.4 Ghz Wi-Fi.

**1.2.** Strong lights may interfere with the device's ability to scan QR codes.

**1.3.** Avoid placing the device behind furniture or near microwaves products. Try to keep it within range of your Wi-Fi signal.

**1.4.** Please check the signal of the camera again before installing it on the shelf to ensure that the signal is good enough. Avoid removing the camera after installation due to weak signal.

## 2. During Installation

**Note:** Before you drill holes in your wall, check that the smart bird feeder has been successfully added to your VicoHome App and is able to stream video.

### 2.1. Find a Position with good Signal

Please install the smart bird feeder in a position where its view is not blocked and ensure that it is within range of the Wi-Fi network. Check if the WIFI signal strength in the yard is enough (you can check the WIFI signal strength through the app). When the smart bird feeder is added to the app, the signal strength of the smart bird feeder will be displayed (click the settings on the right side of the smart bird feeder on the home page to check the signal strength.) When the signal strength is Strong, the position is good for installing the bird feeder.

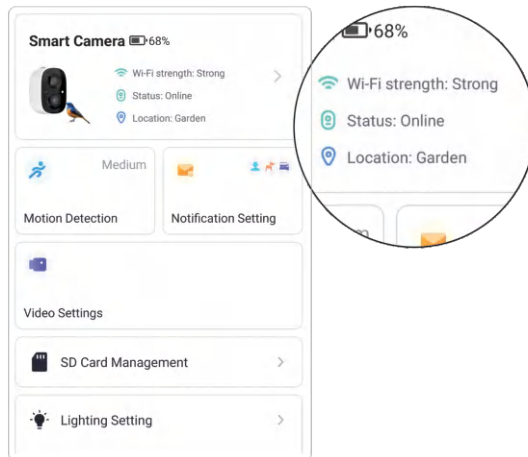

**Note:** It is generally not recommended to have more than two walls between bird feeders and routers.

When the signal strength is Medium, it is necessary to check that the real-time video works smoothly and continuously.

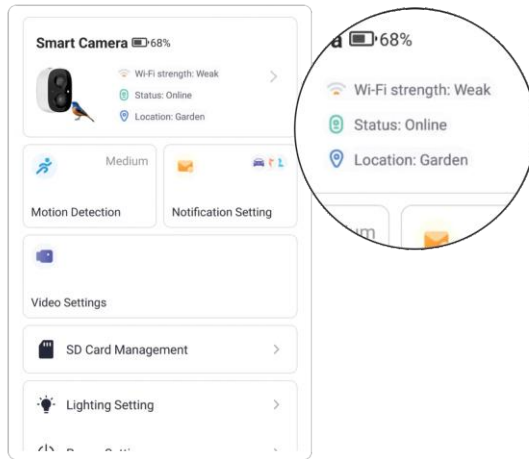

When the signal strength is Weak, do not install the bird feeder in this position.

## 2.2.Wall Installation:

### Step 1:

1. First mark the location of the holes on the wall by using the included drilling template stickers. Then use a 5/16"/8mm drill bit to drill two holes.

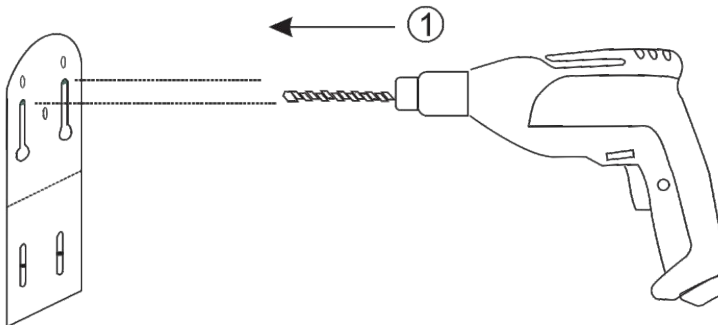

2. Install two anchors to fix the bracket screws.

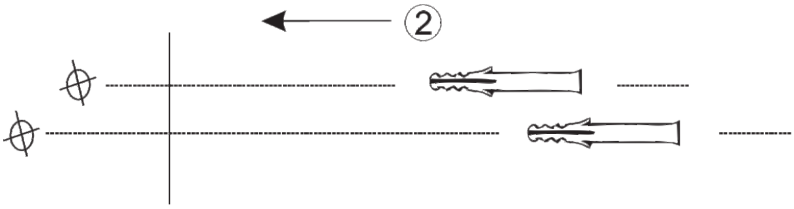

3. Install the mounting bracket on your wall with the two bracket screws provided.

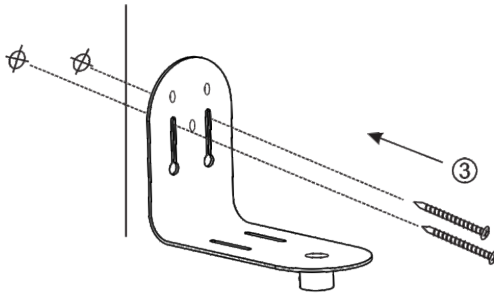

**Step 2:**

Attach the base to the mounting bracket (there are silicone gaskets attached to the mounting bracket to prevent wear of the mounting bracket and base.)

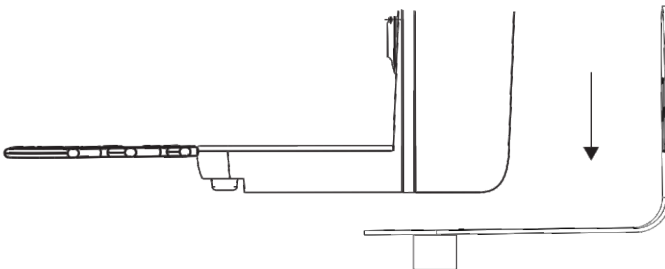



### Step 3:

Screw in the bottom of the interface between the bird seed container and the mounting bracket.

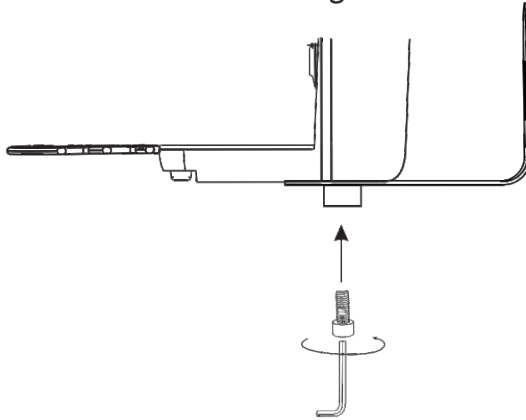

**Note:** Once installed, you can rotate the smart bird feeder based on the background, field of view, and light intensity to get the best angle; the mounting bracket and base should be securely fastened together so they don't wobble when birds fly away or the wind blows.

## 2.3.Tree Installation:

### Step 1:

Wrap the mounting bracket around the tree with a strap.

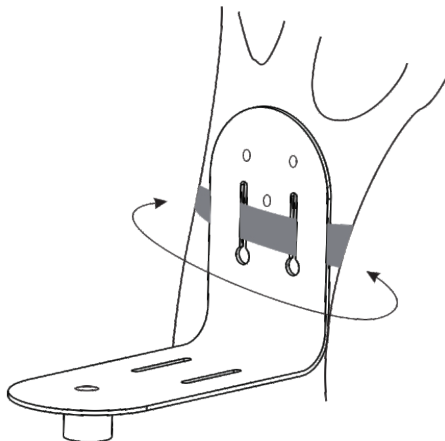

**Step 2:**

Attach the Birdkiss smart bird feeder bottom to the mounting bracket.

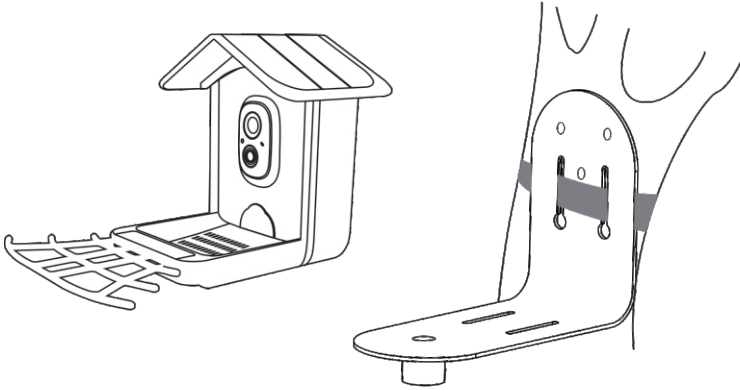

**Step 3:**

Screw in the bottom of the interface between the bird seed container and the mounting bracket.

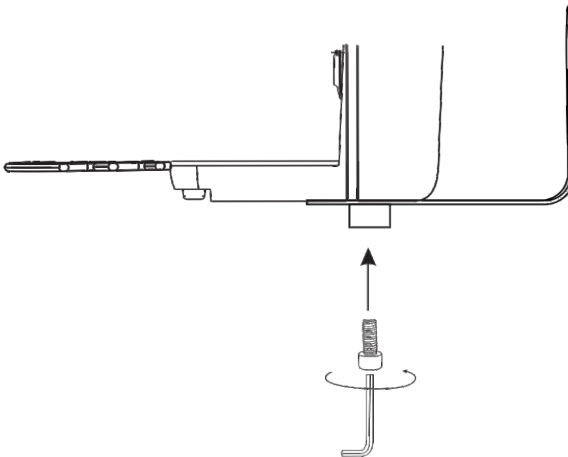

**Note:** Once installed, you can rotate the smart bird feeder based on the background, field of view, and light intensity to get the best angle; the mounting bracket and base should be securely fastened together so they don't wobble when birds fly away or the wind blows.

## 2.4. Stand Installation:

### Step 1:

The Birdkiss smart bird feeder can be placed steadily on a flat surface, but for stability, we recommend that the backplane is installed and fixed on a flat surface. Use the provided drilling template sticker to mark the position of holes on a flat surface. Use a 5/16"/8mm drill bit to drill two holes.

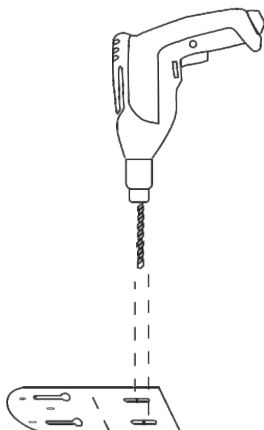

### Step 2:

Install two anchors to fix the bracket screws.

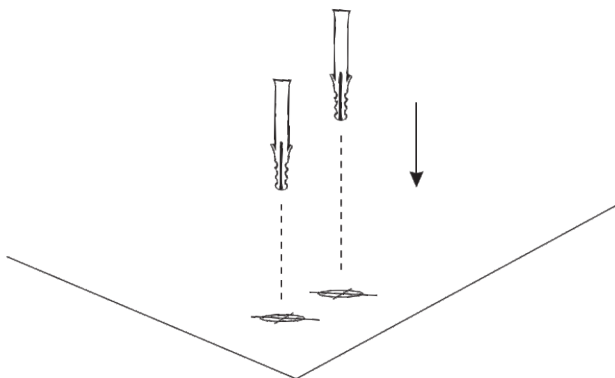

**Step 3:**

Install the Birdkiss feeder bracket on your wall with the two bracket screws provided.

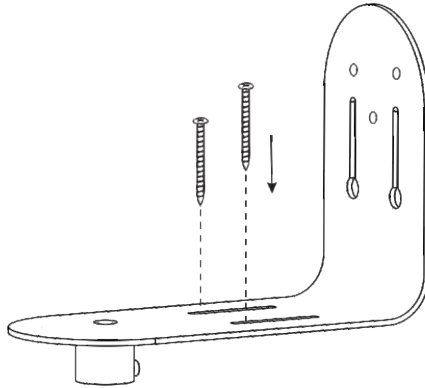

**Step 4:**

Attach the base to the mounting bracket (there are silicone gaskets attached to the mounting bracket to prevent wear of the mounting bracket and base.)

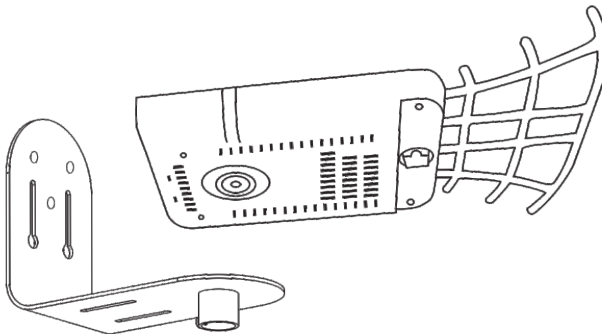

**Step 5:**

Screw in the bottom of the interface between the bird feeder container and the mounting bracket.

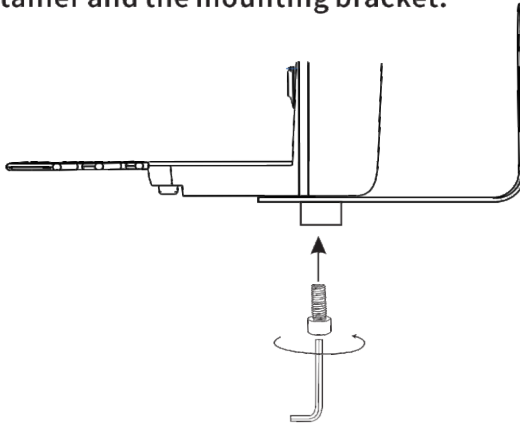

**Note:** Once installed, you can rotate the smart bird feeder based on the background, field of view, and light intensity to get the best angle; the mounting bracket and base should be securely fastened together so they don't wobble when birds fly away or the wind blows.

**2.5.Pole installation**

**Note:** You can also install the mounting bracket to the pole first (refer to the next step).

**Step 1:**

Attach the smart bird feeder bottom to the mounting bracket.

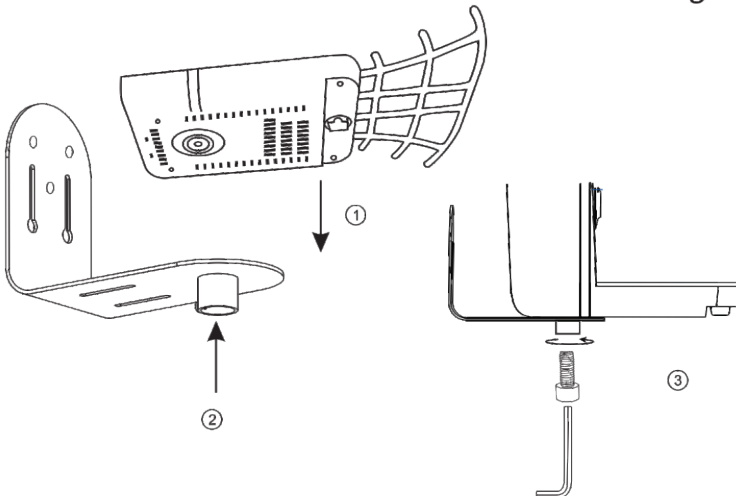

## Step 2:

First insert the pole into the ground, then place the bird feeder on the pole, and finally tighten the screws.

**Note:** It fits any standard-sized birdhouse pole, with a 1"/2.5cm diameter. Please note that the pole itself is not included in the package.

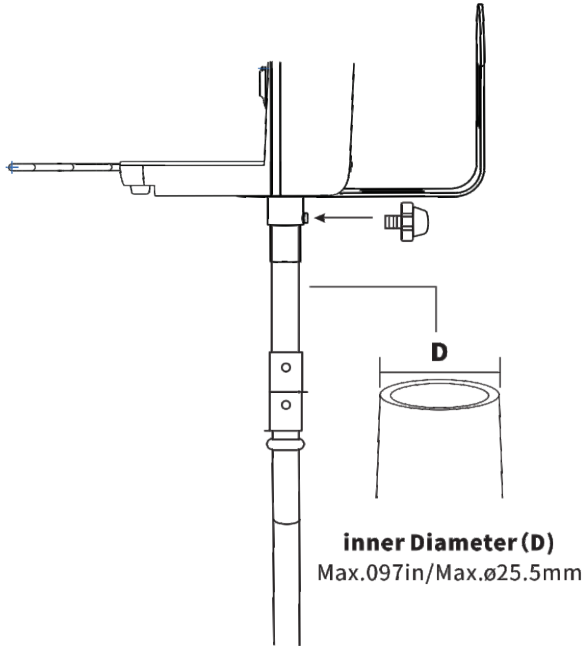

**Note:** Once installed, you can rotate the smart bird feeder based on the background, field of view, and light intensity to get the best angle; the mounting bracket and base should be securely fastened together so they don't wobble when birds fly away or the wind blows.

## 2.6. Use the fruit holder

The smart bird feeder comes with 3 fruit holders that are designed for birds. You can fasten oranges, apples, or other types of fruit on it to attract more birds.

**Step 1:** Screw the fruit holder onto the bird perch, it needs to be tightened so that it will not fall.

**Step 2:** Fasten fruit onto the fruit holder.

## 2.5. Install solar panel

### Step 1:

Please select a position with the most sunlight throughout the year for your solar panel. The solar panel only needs a few hours to direct sunlight to sufficiently power your camera daily. The amount of energy that the solar panel can produce is affected by the weather conditions, seasonal changes, geographic locations, etc.

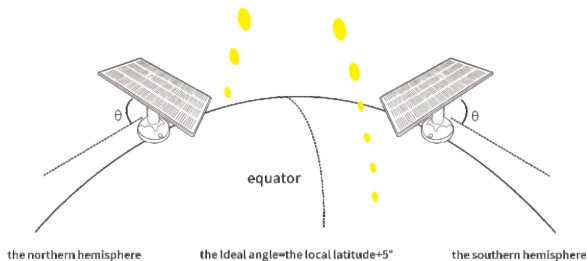

### Step 2:

**A:** Connect the solar panel bracket to the Bird cage bracket with screws.

**B:** Use the drilling tool to punch holes in the wall or tree according to the hole distance of the base. It is recommended to mark the holes on the wall or tree before drilling with the drilling template sticker. Screw the anchors into the holes, and then connect the solar panel bracket to the anchors with screws. (the anchors and screws used here are all in the Solar Panel Kit)

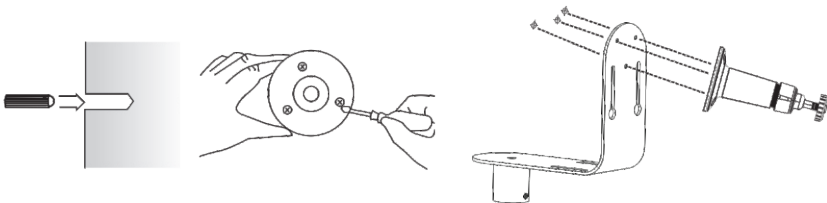

**Step 3:**

Slot the solar panel into the bracket and make sure it's secure.

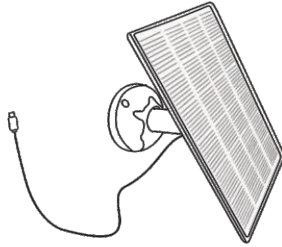

**Step 4:**

Loosen the adjusting control on the bracket and adjust the angle of the solar panel to make it receive direct sunlight, and then re-tighten the adjusting control to secure your setting.

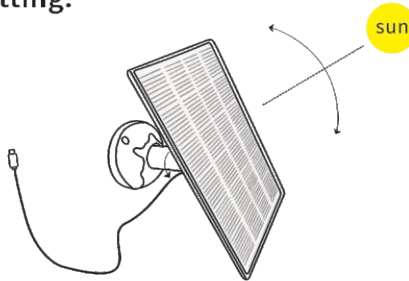

**Step 5:**

Connect the solar panels to the charging port of the bird feeder with the equipped 3-meter Type-C charging cable.

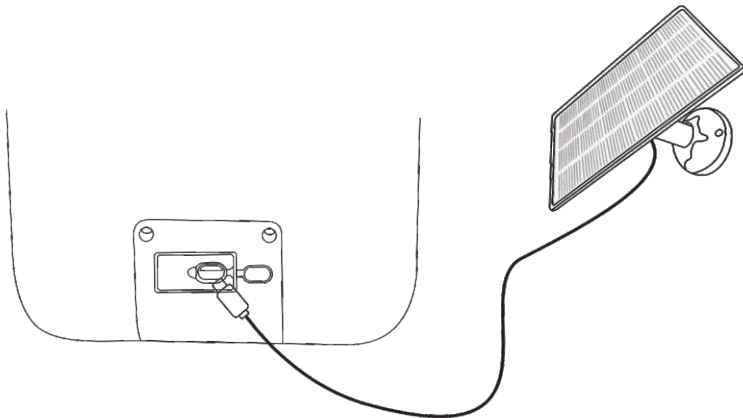



# How to Add Bird Seed

## Step1:

Open the catch on the left side of the bird seed container and gently lift the feeder cover upwards.

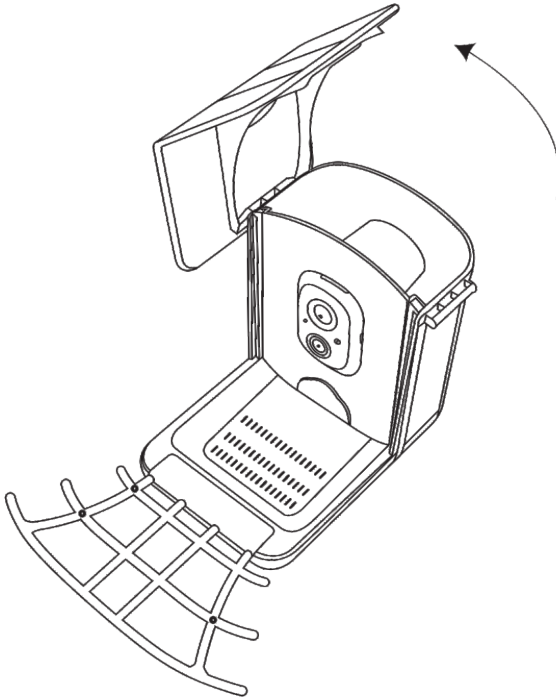

## Step3:

There is a bird seed outlet valve placed in the seed outlet of the bird seed container, please take it out after loading the seeds, and put it inside the feeder cover (like the position shown in the picture, you can also move the seed outlet valve after installing the smart bird feeder in the yard to prevent the seed from leaking out during installation).

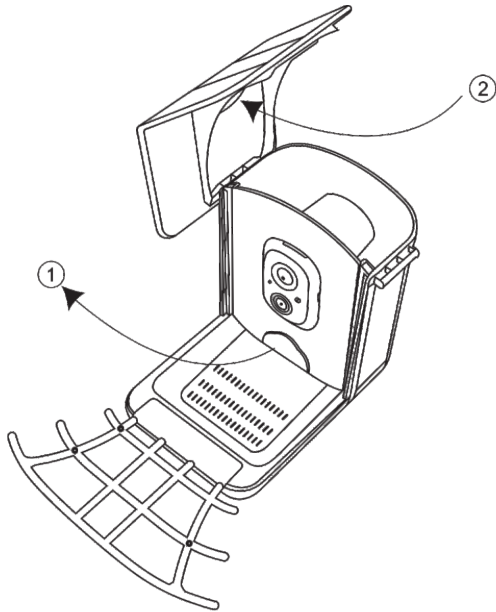

**Step4:**  
Finally, close the feeder cover.

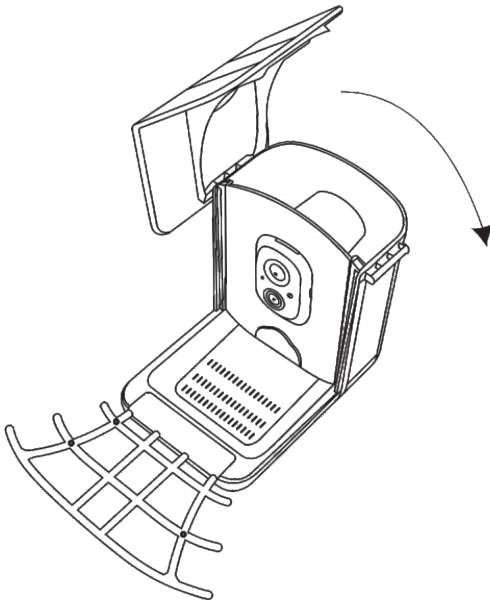

# Cleaning and Maintenance

smart bird feeder is designed with the safety and comfort of our feathered friends in mind and is incredibly easy to clean. Cleaning your feeder is the most effective and most important step towards preventing the spread of avian diseases. We recommend cleaning the feeder once a week with a brush and a mild disinfectant.

1. **Cleaning the smart bird feeder lens:** Add a drop or two of lens cleaning fluid or rubbing alcohol to a microfiber cloth or a cleaning wipe, then wipe the lens gently to remove fingerprints, oil, smudges, dirt, and dust.
2. **Cleaning the base:** After removing the bird seed container, wash it directly with water, you can use a soft brush to clean away the extra seeds and dirt.
3. **Cleaning the inside of the bird seed container:** Fill a silicone measuring cup with water and pour clean water from the bird seed inlet on the top. Let the water flow out naturally and let it dry.
4. **Other:** If the feeder cover, bird perch, mounting bracket, solar panel, and other parts of the bird seed container get dirty, rinse them gently with water and wipe them with a clean cloth.

# How to Do Bird AI Recognition

1. Click 'User' in the lower right corner of the app, and then click 'VicoHome Awareness Plus' to get 'VicoHome Awareness Plus 30-day free trial', You will receive one month of free premium membership and access to the 'Bird Fans Plan', then you will be able to identify 10,000+ birds with the bird fans plan.

**Note:** The most up-to-date information can be found through the app. Monthly subscription is required after the 30-day free trail.

**Cloud recording**

Extend up to 60 days with 10 GB cloud recording storage (3 types of Awareness Plans) to create the most secure video storage so that you will never miss any critical moment.

Lite | VicoHome Awareness

**Intelligent Notification**

VicoHome Awareness Plus 30-day free trial

Get it, buy now

**Activity Zone**

Once you set the Activity Zone, only triggered messages about the accurate location will be pushed, while any other information will be filtered out.

Lite | VicoHome Awareness

	Cloud recording	Intelligent Notification	Activity Zone
No plan	7 days (x0.5GB)	×	×
Basic	15 days (x1GB)	✓	✓
Plus	30 days (x5GB)	✓	✓
Pro	60 days (x10GB)	✓	✓

Plus | Pro | Bird Fans Plan

**Function description**

Get the ability to recognize birds! And remind you with Smart Push!

Support 10000+ species of birds

Need to subscribe Awareness Basic plan or higher plans

**Supported Devices**

Beta Trial | Received

VicoHome Awareness Plus

- Intelligent Service Assistant
- Device Management
- Add Friend's Device
- APP Language
- Location Management
- Feedback
- FAQ
- About VicoHome

2. When the camera detects a bird, it will notify you that a bird has been detected.

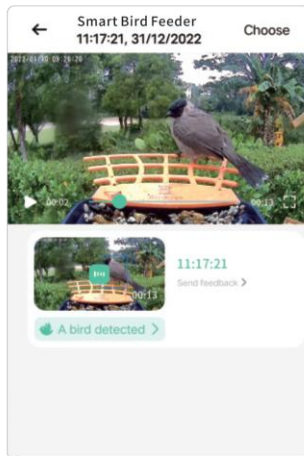

3. Click on 'A bird detected' to identify the bird breed.

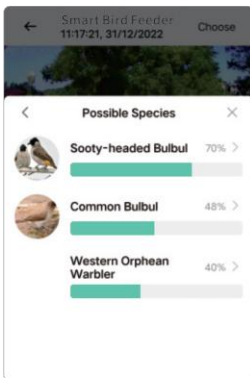

# FAQ

## **Q: How should I solve problem when using the app?**

A: When the app fails, it may be a internet connection problem. You can try restarting the app or internet connection. If the problem with app still exists, please contact us via the VicoHome app .

## **Q:How can I identify birds?**

A: The smart bird feeder will start shooting when the bird arrives, and then you can watch the video through the mobile app, and the information in the video will prompt you to identify what kind bird it is.

## **Q:Will the camera show red lights when night vision is activated?**

A: The built-in infrared lamp beads make the camera only show some dim red lights when night vision is activated, but the image quality is still clear in a low-light environment.

## **Q:Can I use the bird feeder without an SD card?**

A: The smart bird feeder can work normally without a SD card, and the captured videos will be stored in the cloud. Different cloud packages have different storage time and storage capacity.

## **Q:Will I have to pay a monthly subscription to use the app?**

A: We provide free 3-day cloud storage, if you need a more advanced storage package, you can check the package price in the "Vicohome Awareness Plus" in the app.

**Q:What is the maximum length of recording time?**

A: If you set the duration as "Auto", when something appears in the view of the camera, it will start recording a video for up to 3 minutes with monthly subscription.

**Q:How can I quickly view videos by category?**

A: Click the icon in the upper left corner of the 'Library' page to start filtering videos by category. Select the category you want to see and then click 'Save' to view the video playbacks.

**Q: How can I prevent seeds from getting wet when it rains?**

A: The smart bird feeder is equipped with a silicone cover for the bird seed outlet, which can keep the bird seed from excessive moisture when it rains.

**Q:Does the camera support 5.0 Ghz Wi-Fi?**

A: No, currently only 2.4 GHz Wi-Fi is supported.

### Q: Can the camera be used without Wi-Fi?

A: No, the camera must be connected to WiFi when the app is set up. If you want to use smart bird feeder in a place with out Wi-Fi, you can use the hotspot of your mobile phone first, let smart bird feeder connect to it, and then take it outdoors or in the wild. Bird AI recognition doesn't work without the Internet.

### Q: Can the app check the signal strength of the camera?

A: You can check the signal strength through the app. When the camera is added to the app, the signal strength of the camera will be displayed (click the settings on the right side of the camera on the Home Page to check the signal strength.) When the signal strength is Strong, this position is good for installing the bird feeder. When the signal strength is Medium, it is necessary to check whether the real-time video works smoothly. When the signal strength is Weak, do not install it in this position.

