

# Accuphase

Class-A  
PRECISION INTEGRATED STEREO AMPLIFIER

## E-700

- Integrated amplifier with fully balanced configuration from input to output
- Balanced AAVA type volume control ● High-accuracy, high-rigidity volume sensor construction ● Power amplification stage configured as an instrumentation amplifier
- Four-fold parallel push-pull configuration using power MOS-FETs driven in Class A
- Linear power output of 35 watts into 8 ohms, 70 watts into 4 ohms, or 140 watts into 2 ohms ● 160 W output into 1-ohm load (music signals) ● High damping factor of 1,000 ● Strong power supply with massive high-efficiency toroidal transformer and large filtering capacitors ● Protection circuitry using MOS-FET switches





# An integrated amplifier crafted from the technology used in our flagship model

The E-700 is an evolutionary integrated amplifier that incorporates numerous technologies from our 50th anniversary flagship model, the E-800. The preamplifier section uses a Balanced AAVA type volume control with ANCC to create a balanced configuration from input to output and achieve driving perfection. The power amp stage that drives the speakers has been fortified from three elements to four, further increasing reliability. Experience the full breadth of emotion in live performances with the E-700's superior expression.

## Innovation – At the leading edge of technology

### Balanced AAVA type volume control circuit

Conventional preamplifiers use variable resistors to adjust volume, which causes contacts to deteriorate and create grit as well as increase noise at normal volume levels. AAVA, however, produces multiple, widely varying signals from the input signal and controls volume by changing the combination of those signals. This achieves minimum noise levels at all volume levels without any grit. The E-700 relies on Balanced AAVA comprised of balanced AAVA circuits, reducing the overall noise level by 10% compared to conventional models at typical volume positions.

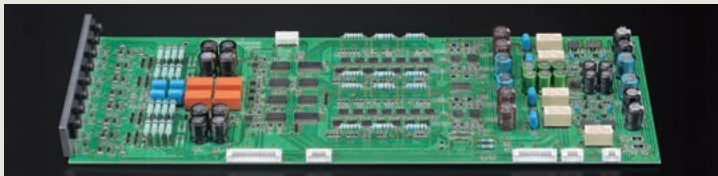

Balanced AAVA type volume control circuit

### High-accuracy, high-rigidity volume sensor construction

The volume sensor mechanism carved from a single aluminum block ensures silky-smooth operation, a weighty operational feel, and accurate position detection. Operations with the remote commander are so quiet that mechanical noise is hardly noticeable.

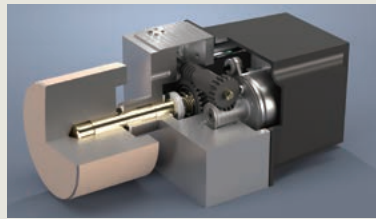

Volume sensor construction

### ANCC significantly reduces distortion and noise (Accuphase Noise and distortion Canceling Circuit)

The E-700's I-V conversion amplifier uses the ANCC principle. ANCC uses a secondary amplifier to cancel out noise and distortion from the main amplifier. The secondary amplifier utilizes a low-noise amplifier (noise density: 1.5 nV/√Hz) to increase the effect of the ANCC. Incorporating this ANCC in the AAVA I-V conversion amplifier drastically improves noise performance, particularly when transitioning from low volume settings to typical volume positions.

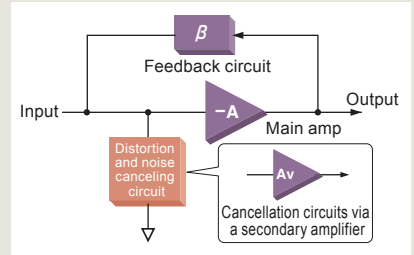

Block diagram of ANCC

### Power amplification stage configured as an instrumentation amplifier

The instrumentation amplifier circuitry's equal impedance on the + and - sides and exceptional external noise suppression provide optimal performance for an audio amplifier.

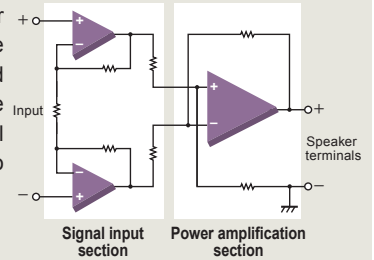

## Sound quality – Simply aiming for the best

### Power amplification stage that achieves linear output

The power amplification stage on both the left and right sides features a large heat sink and employs four-fold parallel push-pull power transistors driven in Class A to provide linear power output of 35 watts into 8 ohms, 70 watts into 4 ohms, and 140 watts into 2 ohms.

### Power supply circuitry delivers steady power

A strong power supply featuring a massive toroidal transformer and two high-voltage, large filtering capacitors (56,000 μF/50 V) offer a stable power supply at all times.

### High damping factor brings out the full potential of speakers

The damping factor represents the amplifier's ability to drive the speakers. A damping factor of 1,000 (guaranteed) extracts the maximum potential from the loudspeakers.

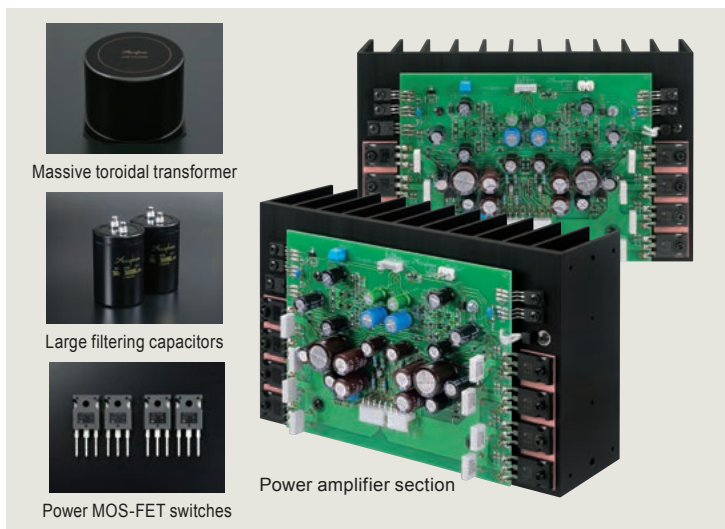

Massive toroidal transformer

Large filtering capacitors

Power MOS-FET switches

Power amplifier section

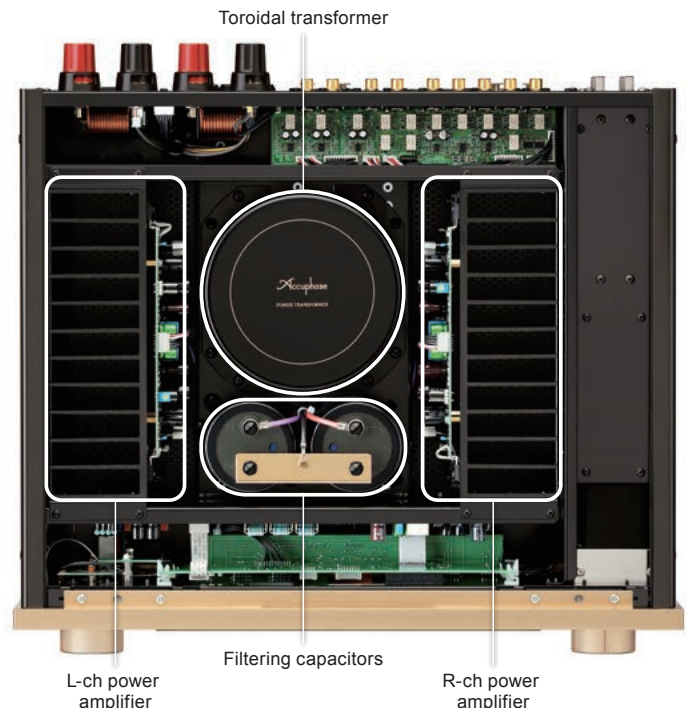

Toroidal transformer

Filtering capacitors

L-ch power amplifier

R-ch power amplifier

# Advanced Features

- Balanced AAVA volume control circuit
- High-accuracy, high-rigidity volume sensor construction
- Highly reliable logic-control signal switching relays
- Power amplification stage configured as an instrumentation amplifier
- Balanced remote sensing to improve the damping factor
- Current feedback amplification circuit topology assures excellent phase characteristics in the high range
- Pre-amplifier I/O terminals (LINE / BALANCED)
- Dedicated, high-quality headphone amplifier
- -20 dB volume attenuator to instantly reduce the sound level
- Speaker output selector ..... ①
- Tone controls using summing active filters ..... ②
- Individual phase setting for each input ..... ③
- Stereo signal can be switched to monophonic operation... ④
- Loudness compensator to adjust audible sonic balance... ⑤
- Display mode selector ..... ⑥
- DAC input selector (when DAC-60 / DAC-50 / DAC-40 is installed)..... ⑦
- MC/MM selector (when AD-60 / AD-50 / AD-30 / AD-20 is installed)..... ⑧
- Subsonic filter ON/OFF selector (when AD-60 is installed) ... ⑨
- MC input impedance selector..... ⑩, ⑩
- 30 ohms / 100 ohms / 200 ohms / 300 ohms (when AD-60 is installed)
- Left/right balance control using AAVA ..... ⑪
- Power amplification input selector (LINE / BALANCED) ... ⑫
- Recorder selector ..... ⑬
- Volume display ..... ⑭
- Sampling frequency display ..... ⑮
- (when DAC-60 / DAC-50 / DAC-40 is installed)
- Five sets of line inputs ..... ⑰
- Speaker output protection circuit guards against short-circuiting ..... ⑱
- Two sets of balanced inputs ..... ⑲
- Two sets of large speaker terminals ..... ⑳
- Highly sensitive LED power meters capable of displaying output levels to -50 dB..... ㉑
- Highly reliable MOS-FET switches ..... ㉒
- High-carbon cast iron insulators for superior vibration damping ..... ㉓



⑭ Volume display



⑮ Sampling frequency display



⑯ MC input impedance display

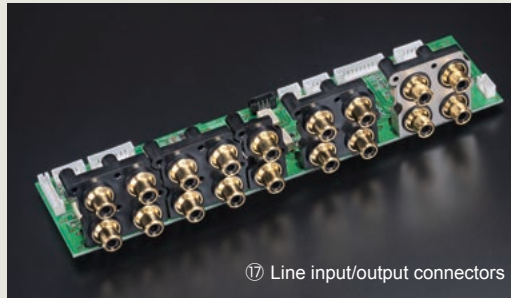

⑰ Line input/output connectors

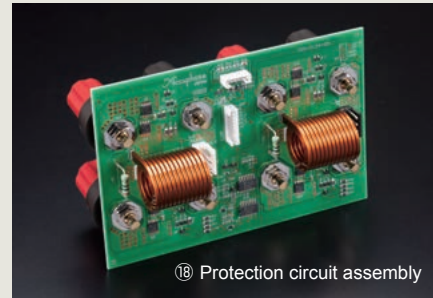

⑱ Protection circuit assembly

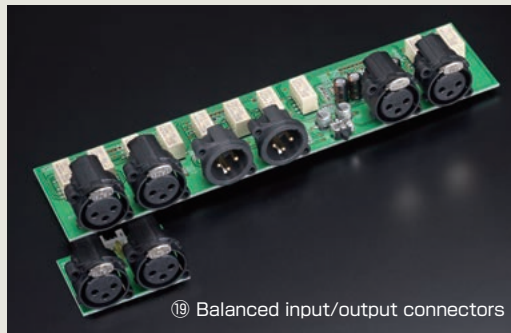

⑲ Balanced input/output connectors



⑳ Speaker terminals connected directly to protection circuitry



㉑ Power meter

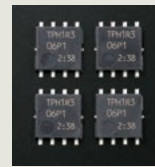

㉒ MOS-FET switches



㉓ High-carbon cast iron insulators

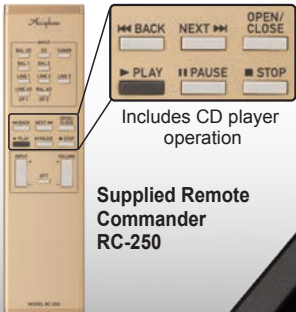

## Bi-amping for Further Enhanced Sound

In a bi-amped setup, the speaker units for the Low range and the High range are driven by separate amplifiers with equal gain, enabling playback with higher sound quality.

\*The speakers must have a built-in crossover network and separate inputs for the Low and High ranges.

\*The example shows a setup with an additional power amplifier for the Low range.

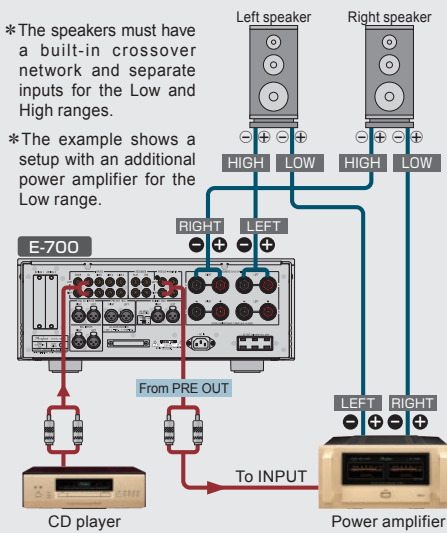

## Option Boards



The rear panel expansion slots allow use of three types of option boards: DAC-60, AD-60, and LINE-10. The E-700 can accommodate two boards according to the requirements.

■ The following option boards can also be used

Digital Input Board	DAC-50/DAC-40/ DAC-30/DAC-20/ DAC-10
Analog Record Input Board	AD-50/AD-30/ AD-20/AD-10/AD-9
Line Input Board	LINE-9

### Analog Record Input Board AD-60



Features a high-performance phono equalizer for playback of analog records.

- Supports MC and MM cartridges
- Load impedance selection (MC only)
- Subsonic filter

Cartridge	MC	MM
Gain	66 dB	40 dB
Input Impedance	30 ohms	47 kilohms
	100 ohms	
	200 ohms	
	300 ohms	

### Digital Input Board DAC-60



Connection example

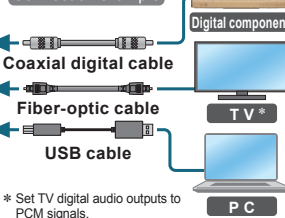

High-performance DAC with two ES9016K2M chips from ESS Technology driven in parallel.

Input	Signal	Sampling Frequencies	Number of Bits
USB	DSD	2.8 MHz	1-bit
		5.6 MHz	
		11.2 MHz: [ASIO only]	
OPTICAL	PCM	32 to 384 kHz	32-bit
		32 to 96 kHz	24-bit
COAXIAL	PCM	32 to 192 kHz	24-bit

\* Set TV digital audio outputs to PCM signals.

### Line Input Board LINE-10



Provides an additional set of unbalanced line level inputs.

## Front Panel

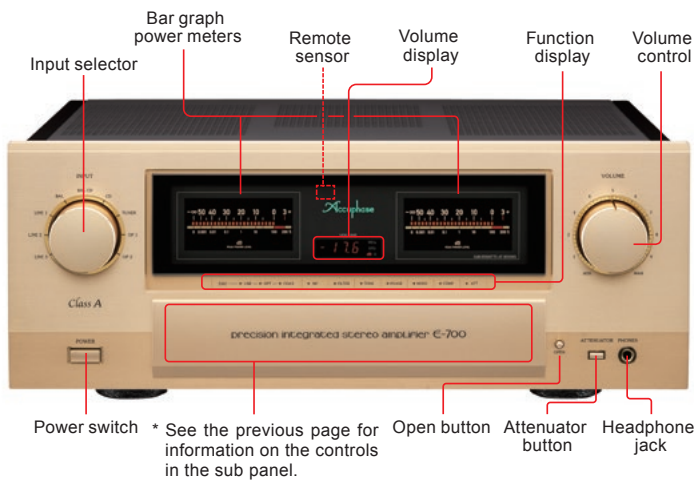

\* See the previous page for information on the controls in the sub panel.

## Rear Panel

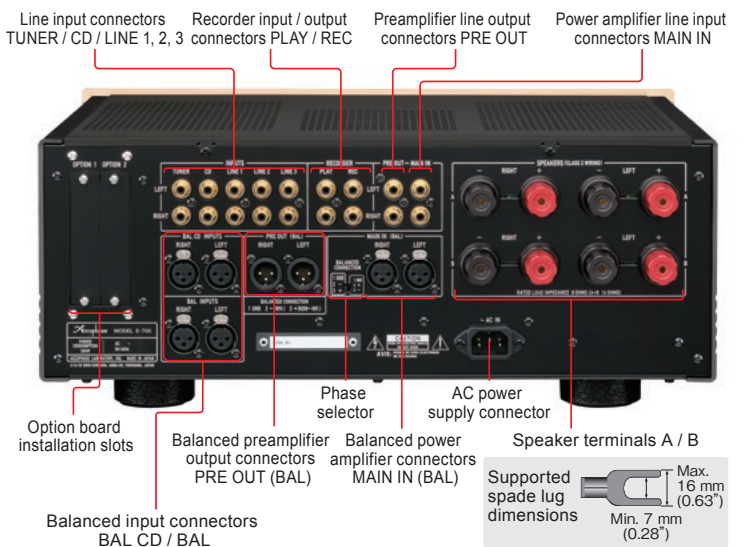

## E-700 Guaranteed Specifications

Rated Output (20 to 20,000 Hz)	1-ohm load *		160 W/ch
	2-ohm load *		140 W/ch
	4-ohm load *		70 W/ch
	8-ohm load		35 W/ch
Total Harmonic Distortion (20 to 20,000 kHz, rated output)	2 to 4-ohm load		0.05 %
	8 to 16-ohm load		0.03 %
Intermodulation Distortion	0.01 %		
Frequency Response	At rated output	INPUT (BALANCED / LINE)	20 to 20,000 Hz (0, -0.5 dB)
		MAIN IN (BALANCED / LINE)	20 to 20,000 Hz (0, -0.2 dB)
	At 1 W output	MAIN IN (BALANCED / LINE)	3 to 150,000 Hz (0, -3.0 dB)
Damping Factor	1,000		
Input Sensitivity	At rated output	INPUT (BALANCED / LINE)	83.9 mV
		MAIN IN (BALANCED / LINE)	666 mV
	EIA (at 1 W output)	INPUT (BALANCED / LINE)	14.2 mV
		MAIN IN (BALANCED / LINE)	113 mV
Input Impedance	INPUT (BALANCED)		40 kilohms
	INPUT (LINE)		20 kilohms
	MAIN IN (BALANCED)		40 kilohms
	MAIN IN (LINE)		20 kilohms
Max. Input Voltage	INPUT (BALANCED / LINE) 5.0 V		
Output Voltage	At rated output	PRE OUTPUT (BALANCED / LINE)	0.666 V
Output Impedance	PRE OUTPUT (BALANCED / LINE) 50 ohms		
Gain	INPUT (BALANCED / LINE) → PRE OUTPUT (BALANCED / LINE)		18 dB
	MAIN IN (BALANCED / LINE) → SPEAKER OUTPUT		28 dB

Tone Controls	Turnover frequency and adjustment range	Bass: 300 Hz Treble: 3 kHz	±10 dB ±10 dB
Loudness Compensator	+6 dB (100 Hz)		
Attenuator	-20 dB		
S/N Ratio	At rated output (Input shorted, A weighting)	INPUT (BALANCED)	103 dB
		INPUT (LINE)	103 dB
	EIA	MAIN IN (BALANCED / LINE)	117 dB
		MAIN IN (BALANCED / LINE)	97 dB
Power Meters	Bar graph meters, Output voltage (dB) using 26 points, with ON/OFF switch		
Headphones Jack	Compatible impedance		8 ohms or higher
Power Requirements	120 V, 220 V, 230 V AC (voltage as indicated on rear panel) 50 / 60 Hz		
Power Consumption	Idle		178 W
	In accordance with IEC 62368-1		220 W
Maximum Dimensions	Stand-by 0.3 W		
	Width 465 mm (18.3") × Height 191 mm (7.5") × Depth 428 mm (16.9")		
Mass	Net	24.9 kg (54.9 lbs)	
	In shipping carton	32 kg (71 lbs)	

\* Music signals only

● Measurement methods for Guaranteed Specifications adhere to JEITA CP-1301A and IEC 60268-3.

### Supplied accessories

- AC power cord
- Remote Commander RC-250

### Remarks

- ★ This product is available in versions for 120/220/230 V AC. Make sure that the voltage shown on the rear panel matches the AC line voltage in your area.
- ★ The 230 V version has an Eco Mode that switches power off after 120 minutes of inactivity.
- ★ The shape of the plug of the supplied AC power cord depends on the voltage rating and destination country.

