



FITTING MANUAL

Product Name : FRONT BUMPER

Part No : OP 0123

Car Model : FORD RANGER (2011-2014)



MADE IN THAILAND



OPTION 4WD



option4wdofficial



info@option4wd.co.th



PART LISTS

PRODUCT : FRONT BUMPER
SUITE TO VEHICLE : FORD RANGER (2011-2014)

1		CENTER PART, 1 SET
4		PROTECTION PLATE, 1 SET
7		SUPPORT(middle), 1 SET (L+R)
10		SPORT LIGHT BRACKET, 1 SET (L+R)
13		LED,LIGHT 1 SET

2		SIDE PART, 1 SET (L+R)
5		FRONT GUARD KIT, 1 SET
8		GUARD, 1 SET (L+R)
11		PLATE NUMBER BRACKET, 1 SET

3		UNDER SIDE PART, 1 SET (L+R)
6		SUPPORT, 1 SET (L+R)
9		COVER, 1 SET (L+R)
12		GRILLED BRACKET, 1 SET 2PCS



FITTING INSTRUCTION

PRODUCT : FRONT BUMPER
SUITE TO VEHICLE : FORD RANGER (2011-2014)

FRONT-VIEW

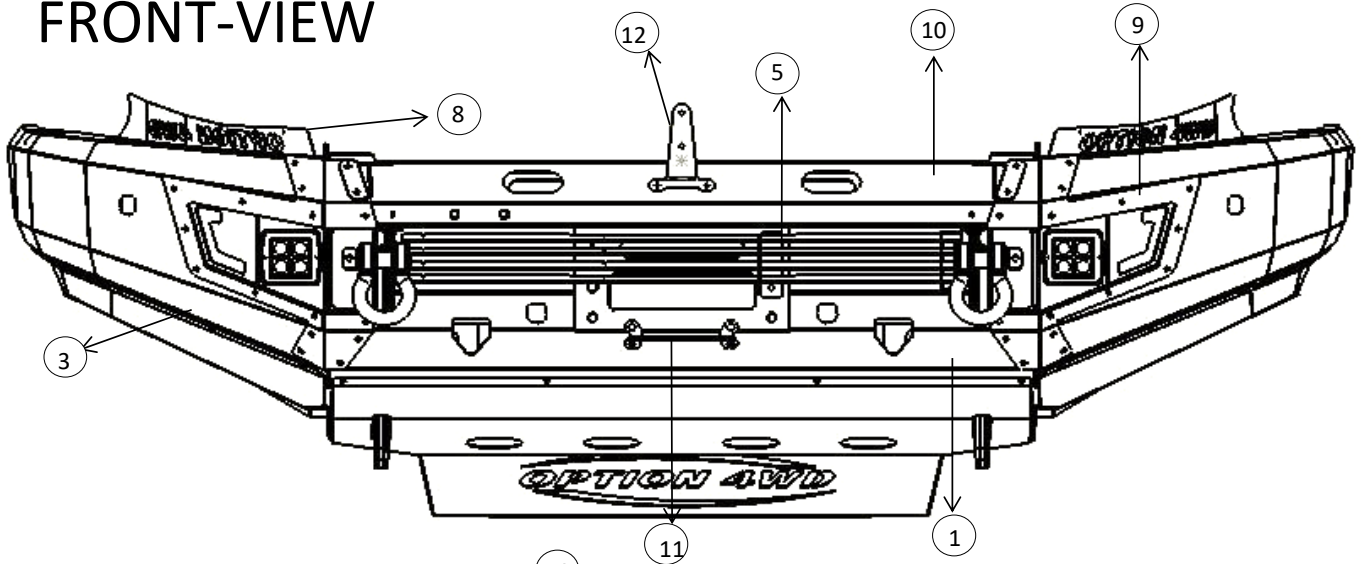

REAR-VIEW

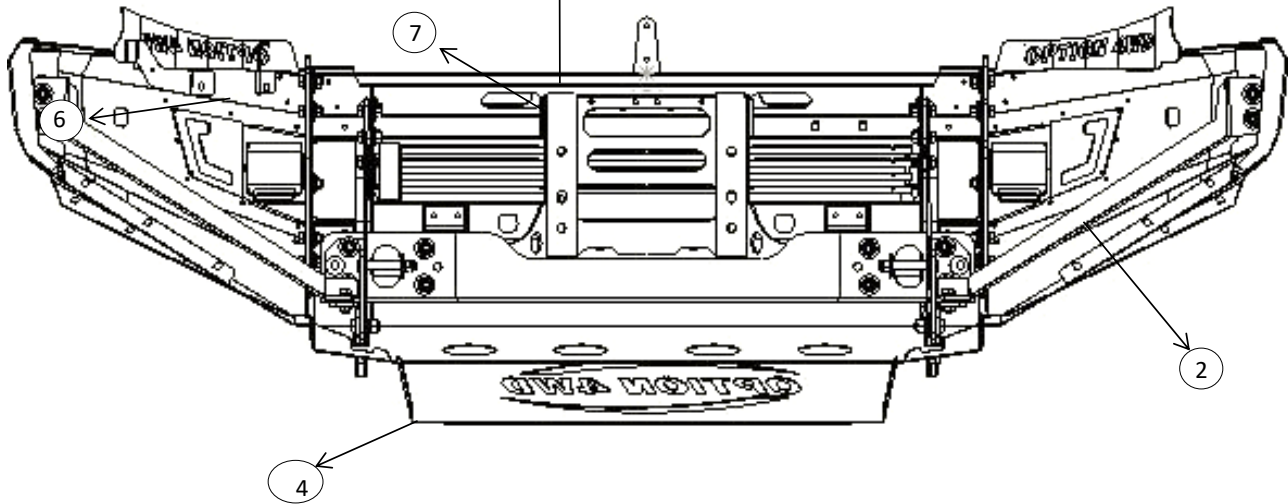









PART LIST

PRODUCT : FRONT BUMPER

SUITE TO VEHICLE : FORD RANGER (2011-2014)

NO	PICTURE	NAME	QTY	UNIT	NOTE
1		M6x1.0x20	48	Pcs.	
		WASHERS M6	48	Pcs.	
		FLANG NUT M6x1.0	44	Pcs.	
2		M12x1.25x75	2	Pcs.	
		WASHERS M12	4	Pcs.	
		HEX NUT M12x1.25	2	Pcs.	
3		M10x1.25x30	36	Pcs.	
		SPING WASHERS M10	36	Pcs.	
		WASHERS M10	72	Pcs.	
		FLANG NUT M10x1.25	36	Pcs.	
4		M6x1.0x20	20	Pcs.	
		WASHERS M6	20	Pcs.	
		CAGE NUT M6	20	Pcs.	



FITTING INSTRUCTION

PRODUCT : FRONT BUMPER

SUITE TO VEHICLE : FORD RANGER (2011 - 2014)

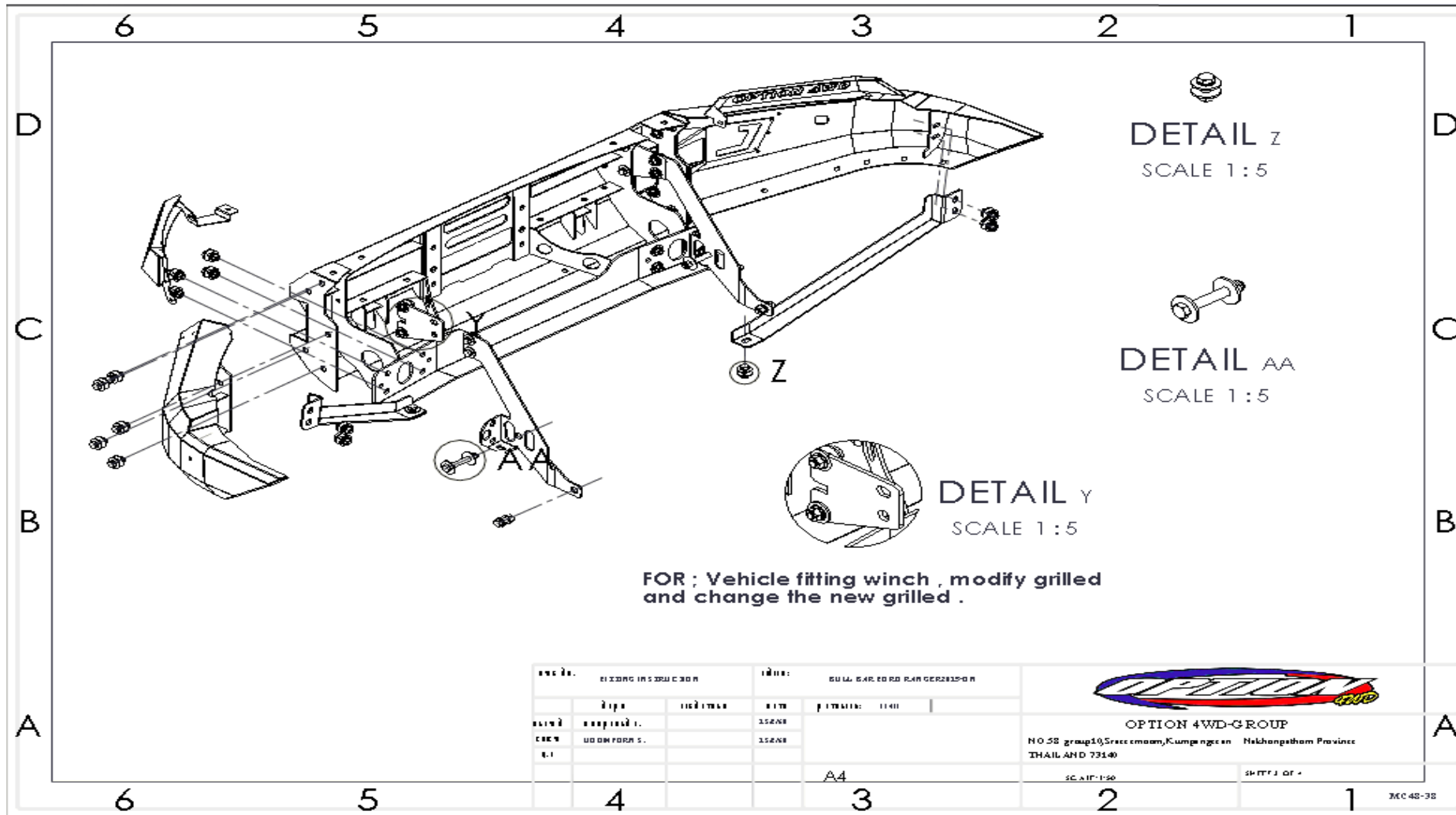



Torque Setting of Fastener

Mounting bolts must be tightened to torque's specified following ;

bolt Diameter (mm.)	Torque (Nm)	Torque (ft.lb)
M8	22	16
M12	77	57

Fitting Instructions Bull Bar FORD RANGER (2011-2014)

Installation Both left side and right side are alike.

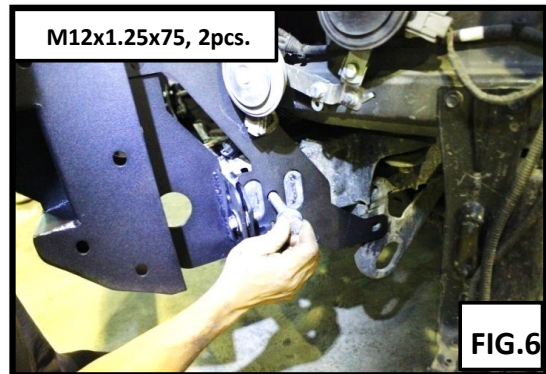
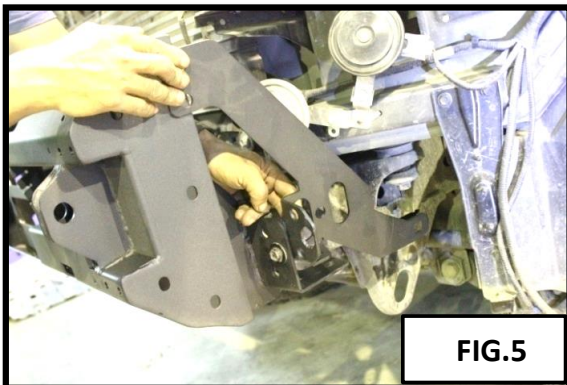
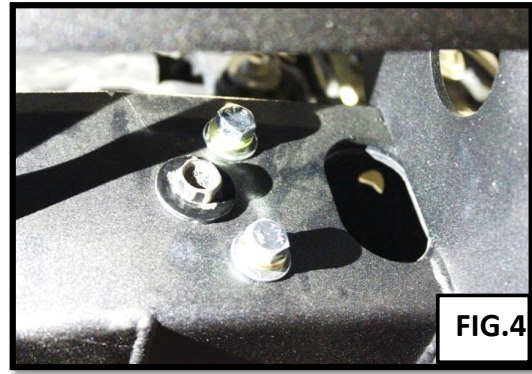
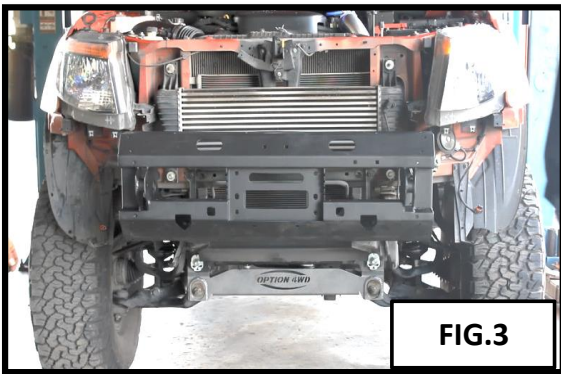

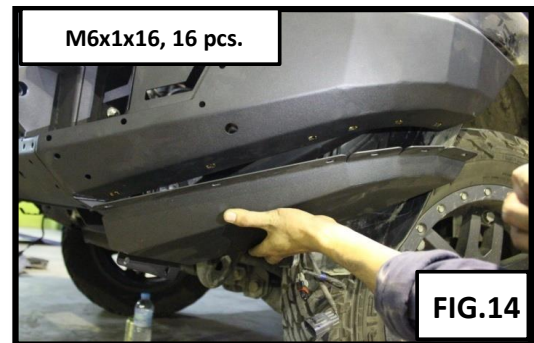
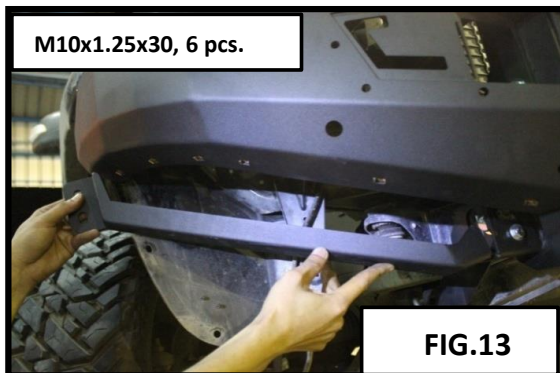
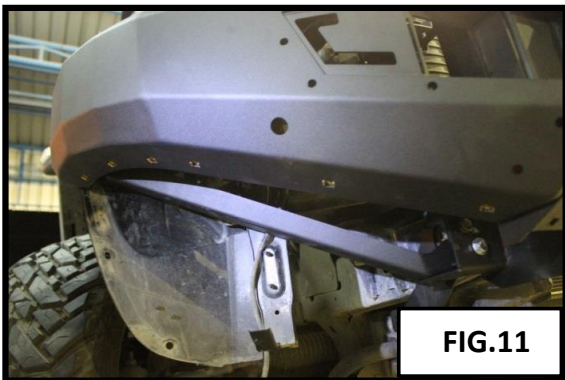
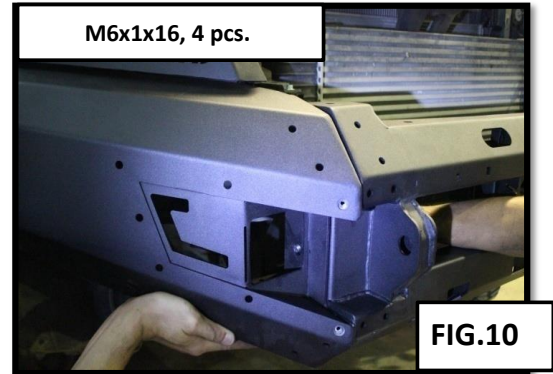
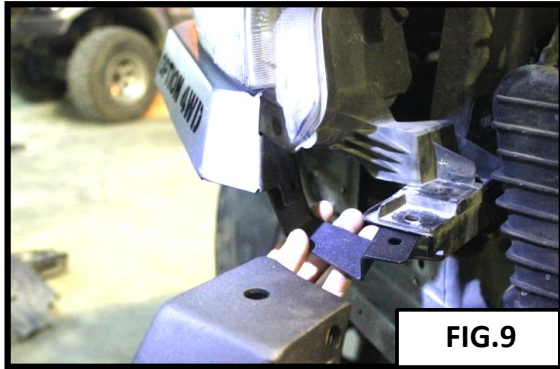
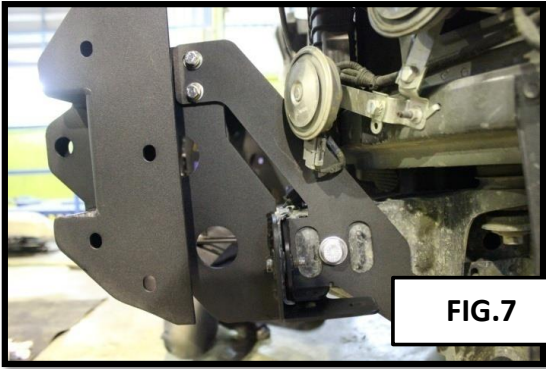

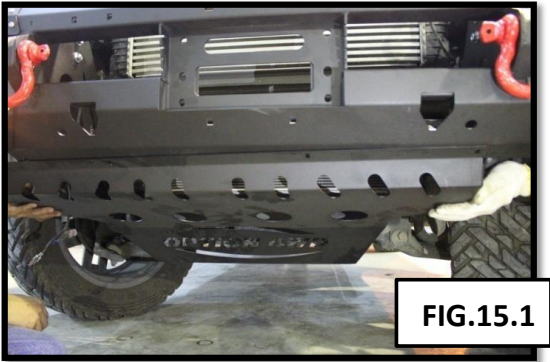

FIG.15.1

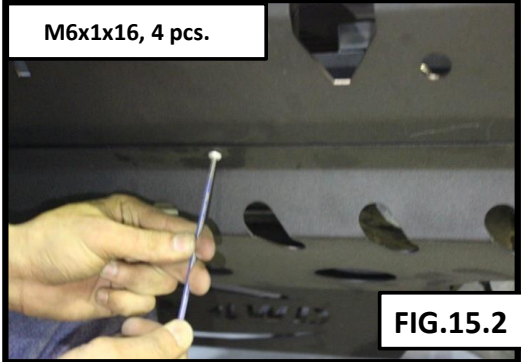

FIG.15.2

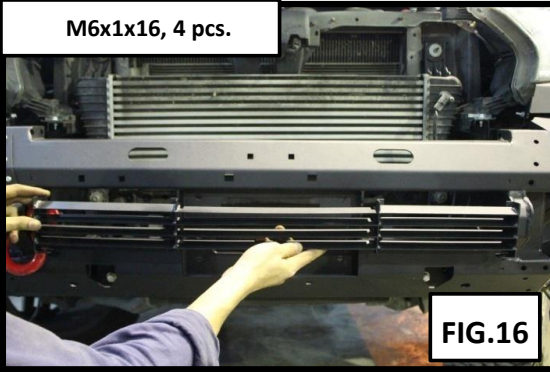

FIG.16

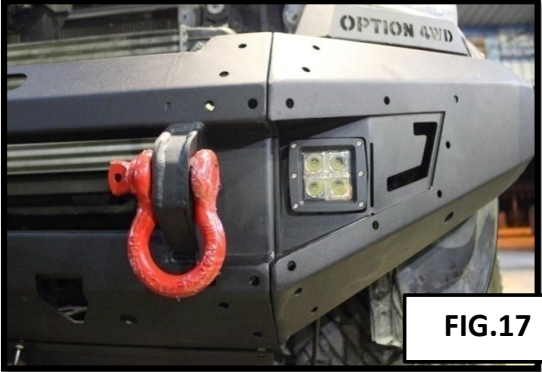

FIG.17

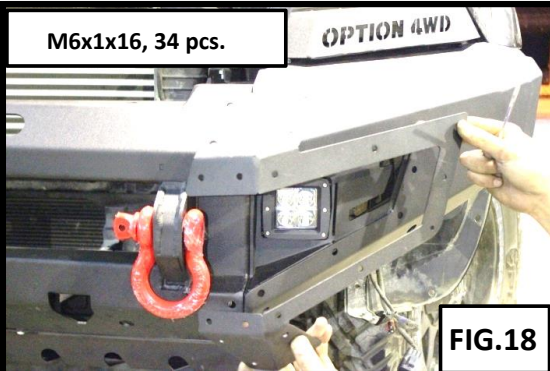

FIG.18

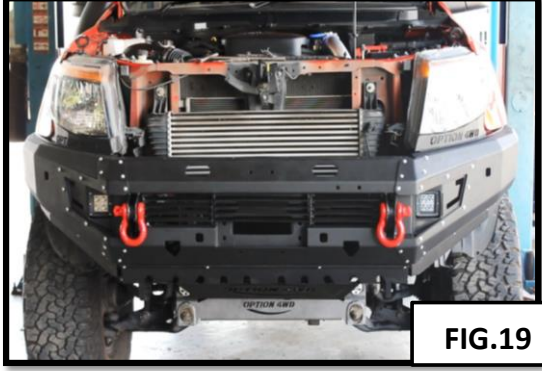

FIG.19



FIG.20