



RGB/CCT/Dimming 3 Channel LED RF Controller

Model No.: V3

3 Channels/Step-less dimming/Wireless remote control/Auto-transmitting/Synchronize



FC CE RoHS EMC LVDRED

Features

- Match with RF 2.4G single zone or multiple zone single color, dual color and RGB/RGBW remote control.
- One RF controller accept up to 10 remote control.
- 4096 levels 0-100% dimming smoothly without any flash.
- When using with RGB light, built in 10 dynamic mode, include jump or gradual change style.
- Auto-transmitting function: Controller automatically transmit signal to another controller with 30m control distance. Synchronize on multiple number of controllers.
- Light on/off fade time 3s selectable.

Technical Parameters

Input and Output		Dimming data	
Input voltage	12-24VDC	Input signal	RF 2.4GHz
Input current	12.5A	Control distance	30m(Barrier-free space)
Output voltage	3 x (12-24)VDC	Dimming gray scale	4096 (2 ¹²) levels
Output current	3CH,4A/CH	Dimming range	0-100%
Output power	144-288W(12-24V)	Dimming curve	Logarithmic
Output type	Constant voltage	PWM Frequency	1000Hz (default)
Environment		Safety and EMC	
Operation temperature	Ta: -30OC ~ +55OC	EMC standard (EMC)	ETSI EN 301 489-1 V2.2.3 ETSI EN 301 489-17 V3.2.4
Case temperature (Max.)	75OC	Safety standard(LVD)	EN 62368-1:2020+A11:2020
IP rating	IP20	Radio Equipment(REDE)	ETSI EN 300 328 V2.2.2 CE,EMC,LVD,RED
Certification		Certification	
Warranty and Protection		Weight	
Warranty	5 years	Net weight	0.038 kg
Protection	Reverse polarity Short circuit	Gross weight	0.049 kg

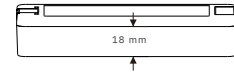
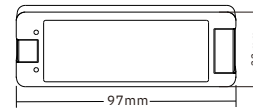
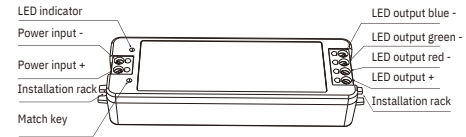

Wiring Diagram

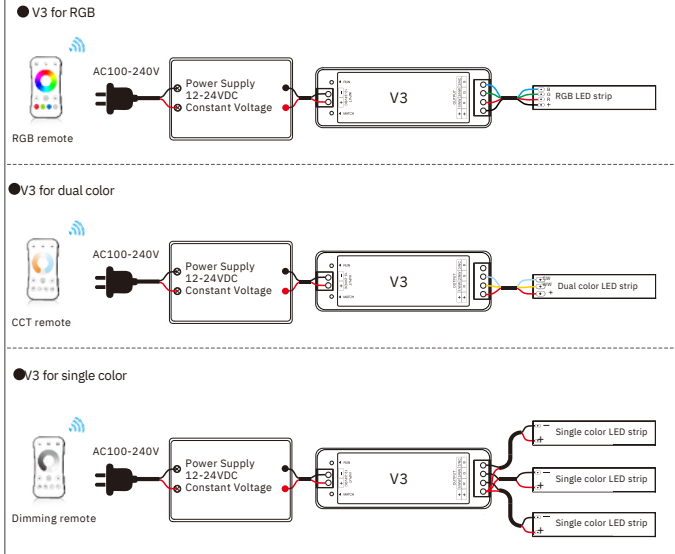

Match Remote Control (two match ways)

End user can choose the suitable match/delete ways. Two options are offered for selection:

Use the controller's Match key

Match:

Short press match key, immediately press on/off key (single zone remote) or zone key (multiple zone remote) on the remote.

The LED indicator fast flash a few times means match is successful.

Delete:

Press and hold match key for 5s to delete all match, The LED indicator fast flash a few times means all matched remotes were deleted.

Use Power Restart

Match:

Switch off the power of the receiver, then switch on power. Repeat again.

Immediately short press on/off key (single zone remote) or zone key (multiple zone remote) 3 times on the remote. The light blinks 3 times means match is successful.

.Delete:

Switch off the power of the receiver, then switch on power. Repeat again.

Immediately short press on/off key (single zone remote) or zone key (multiple zone remote) 5 times on the remote. The light blinks 5 times means all matched remotes were deleted.

Application notes

1. All the receivers in the same zone.

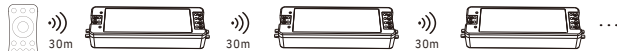

RF remote

Auto-transmitting: One receiver can transmit the signals from the remote to another receiver within 30m, as long as there is a receiver within 30m, the remote control distance can be extended.

Auto-synchronization: Multiple receivers within 30m distance can work synchronously when they are controlled by the same remote, under same dynamic mode and with same speed.

Receiver placement may offer up to 30m communication distance. Metals and other metal materials will reduce the range.

Strong signal sources such as WiFi routers and microwave ovens will affect the range.

We recommend for indoor applications that receiver placements should be no further apart than 15m.

2. Each receiver(one or more) in a different zone, like zone 1, 2, 3 or 4.



Light on/off fade time

Long press match key 5s, then short press match key 3 times, the light on/off time will be set to 3s, the indicator light blink 3 times.

Long press match key 10s, restore factory default parameter, the light on/off time also restore to 0.5s.

RGB Dynamic mode list

No.	Name	No.	Name
1	RGB jump	6	RGB fade in and out
2	RGB smooth	7	Red fade in and out
3	6 color jump	8	Green fade in and out
4	6 color smooth	9	Blue fade in and out
5	Yellow cyan purple smooth	10	White fade in and out

Dual color control

CH1=Warm white LED

CH2=Cool white LED

Each channel can supply up to 96W(@24V) and white balance can be controlled as such:

	Color temperature	Cool white	Neutral white	Warm white
		CH1=0W,CH2=96W	CH1=48W,CH2=48W	CH1=96W,CH2=0W

Linear dual color tuning

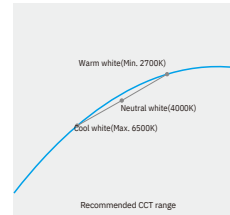

Dimming curve for CCT

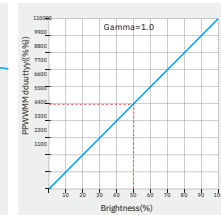

Dimming curve for RGB/DIM

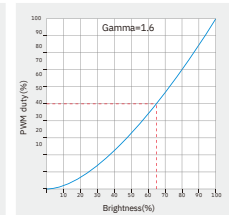

Malfunctions analysis & troubleshooting

Malfunctions	Causes	Troubleshooting
No light	1. No power. 2. Wrong connection or insecure.	1. Check the power. 2. Check the connection.
Wrong color	1. Wrong connection of R/G/B wires.	1. Reconnect R/G/B wires.
Uneven intensity between front and rear, with voltage drop	1. Output cable is too long. 2. Wire diameter is too small. 3. Overload beyond power supply capability. 4. Overload beyond controller capability.	1. Reduce cable or loop supply. 2. Change wider wire. 3. Replace higher power supply. 4. Add power repeater.
No response from the remote	1. The battery has no power. 2. Beyond controllable distance. 3. The controller did not match the remote.	1. Replace battery. 2. Reduce remote distance. 3. Re-match the remote.