

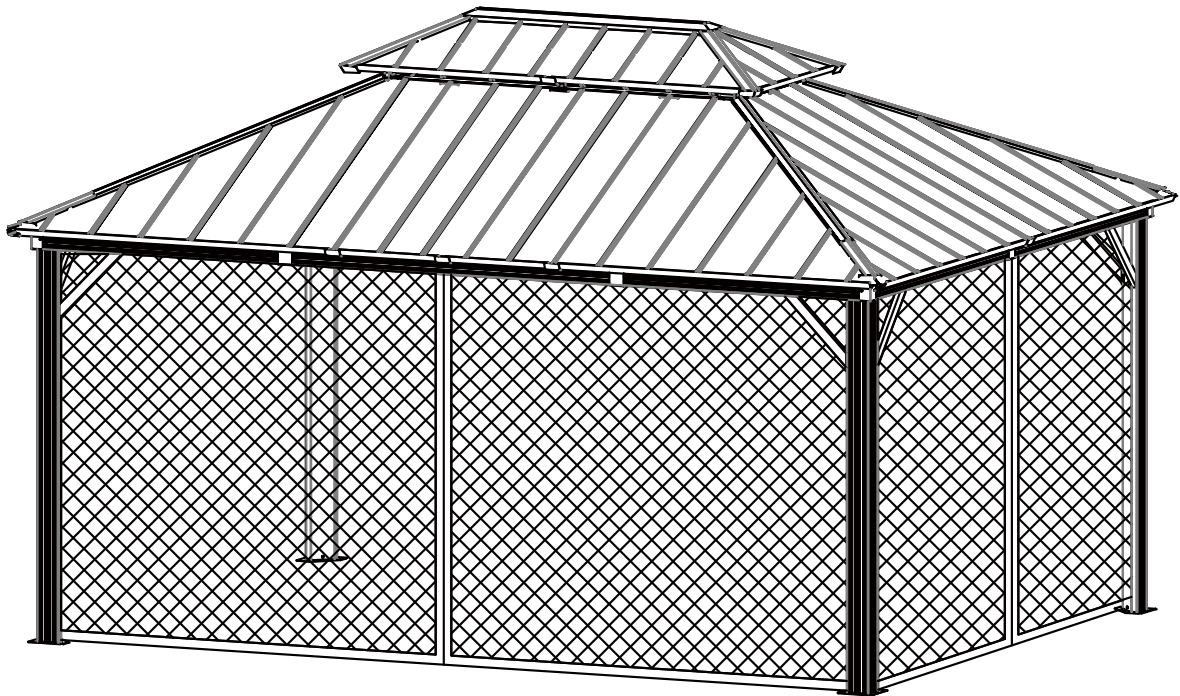

ITEM#
SGS-D00501-5

12'×16'

Andes Hardtop Gazebo with Double Roof



Assembly Manual



Thank you

Thank you for your purchase of Olilawn Gazebo and follow this assembly and operation guide.

To reduce personal injury and damage to your gazebo, please attach your gazebo curtain to the post when it is incoming over **20 mph** wind.

We recommend a **five-person team** for assembly and disassembly.

If you like our products,
please follow more.

The logo for Olilawn features a stylized 'O' composed of several dark green circles of varying sizes, followed by the word 'lilawn' in a bold, dark green, sans-serif font.

Olilawn

Warnings and Cautions

- Please retain this instruction for future usage and read carefully before assembly.
- Make sure you have all the parts & hardware as the item list shows.
- 5 adults or more are recommended to install your gazebo.
- Do not discard any of the packaging until you have checked that you have all the parts and pack of fittings.
- Check all bolts for tightness before use, and periodically check and tighten bolts to ensure your gazebo works properly.
- Some parts might have sharp edges/corners. Please follow basic safety precautions to reduce the risk of hurt.
- It is essential to place the gazebo on level ground and not less than 6 feet from any obstruction such as fences, garages, the house, overhanging branches, laundry lines, or electrical wires.
- Lastly, be careful the parts are not swallowed by pets and kids.

Pre-assembly

TOOLS THAT MAY BE REQUIRED (NOT included in the boxes)

*NOTE: Tools / equipment are not shown to actual size and scale

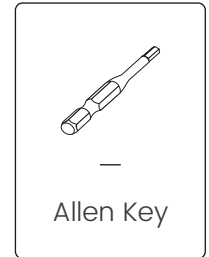
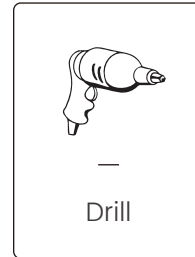
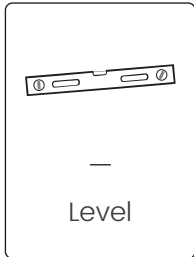

EQUIPMENT REQUIRED (NOT included in the boxes)

*NOTE: Equipment are not shown to actual size and scale

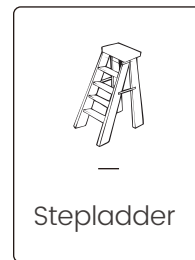

Matters needing attention



Five or more people are required for assembly.



Do not fully tighten screws prior to complete assembly.

Mounting Blueprint

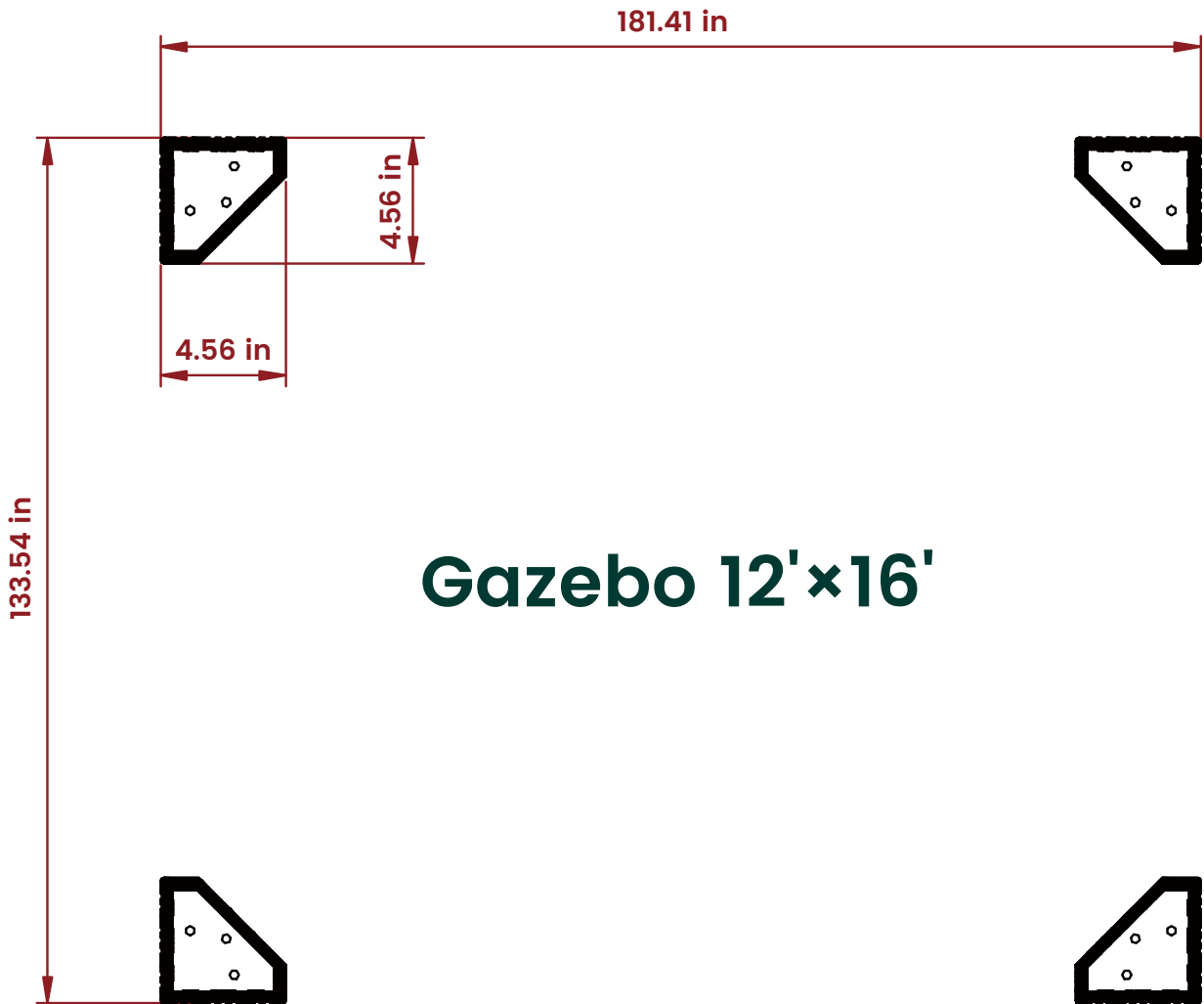

1

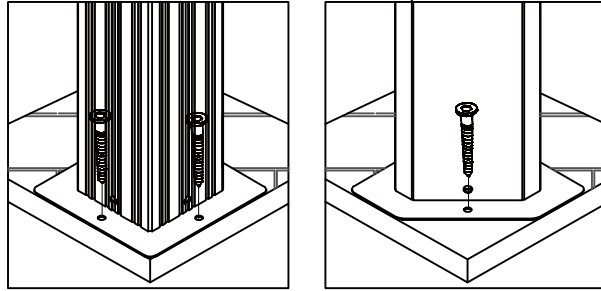





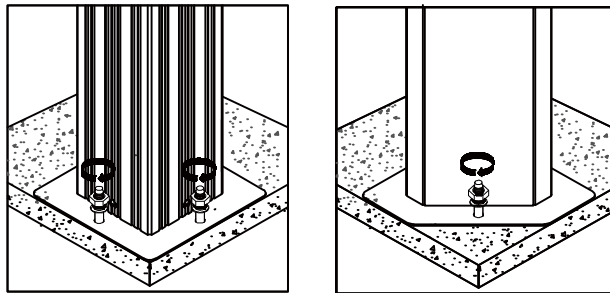





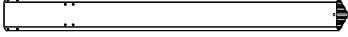

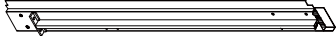
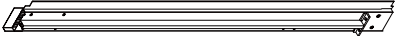

If the deck is hard wood, you can use M6×80 expansion bolts to mount the gazebo.
(Not included in the parts)

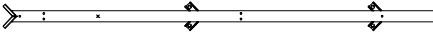
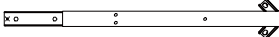



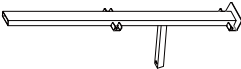
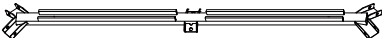







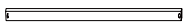

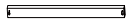



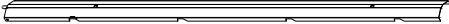

2

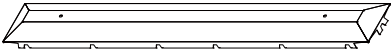
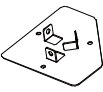
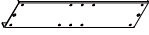

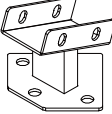
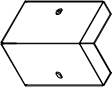
If the ground is concreted, you can use M6×80 hexagon bolt to mount the gazebo.

Checklist

	 A x4	 B x2		
	 C x2	 D x2		
	 E x2	 F1 x4	 F2 x4	
	 G1 x4	 G2 x4		
	 H x2	 I x2		
	 J x8	 K1 x4		
	 K2 x2	 L x1		
	 M x2	 N1 x2	 N2 x2	 O x2
	1			

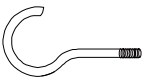
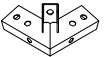
	 P x4	 Q x4	 R x8	 S x8
	 T x8	 U x2		
	 V1 x4		 V2 x4	
	 W1 x2	 W2 x2	 X1 x4	
	 X2 x4		 Y x1	
	 HD1 x4	 HD2 x6	 HD3 x8	 HD4 x4
	 HD5 x4	 HD6 x4	 HD7 x4	 HD8 x8
	 HD9 x4	 HD10 x2	 HD11 x1	 HD12 x4
2				

RF1 x4

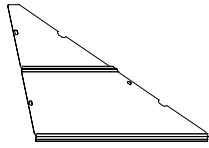

RF2 x4

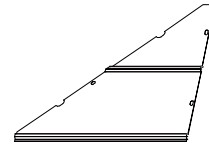

RF3 x4



RF4 x2



RF5 x4

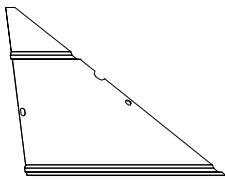

RF6 x4

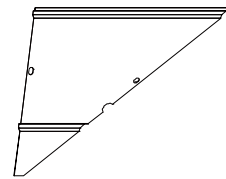

RF7 x4

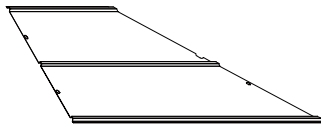

RF8 x4

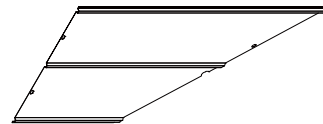

RF9 x4



RF10 x4



RF11 x6



RF12 x2

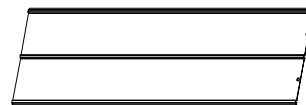







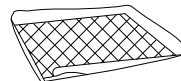

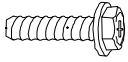
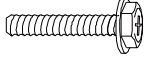

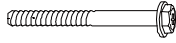
RF13 x2

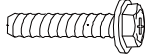

NET x1

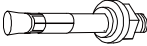

 M6 x 20 AA x310	 M6 x 40 BB x36	 M5 x 10 CC x8	 M6 x 55 DD x14
 M6 EE x12	 M6 FF x12	 M6 x 15 GG x86	 M6 x 25 HH x16
 II x64	 D8 * 180 PP x12	 M6 x 80 UU x12	 M6 Z1 x2

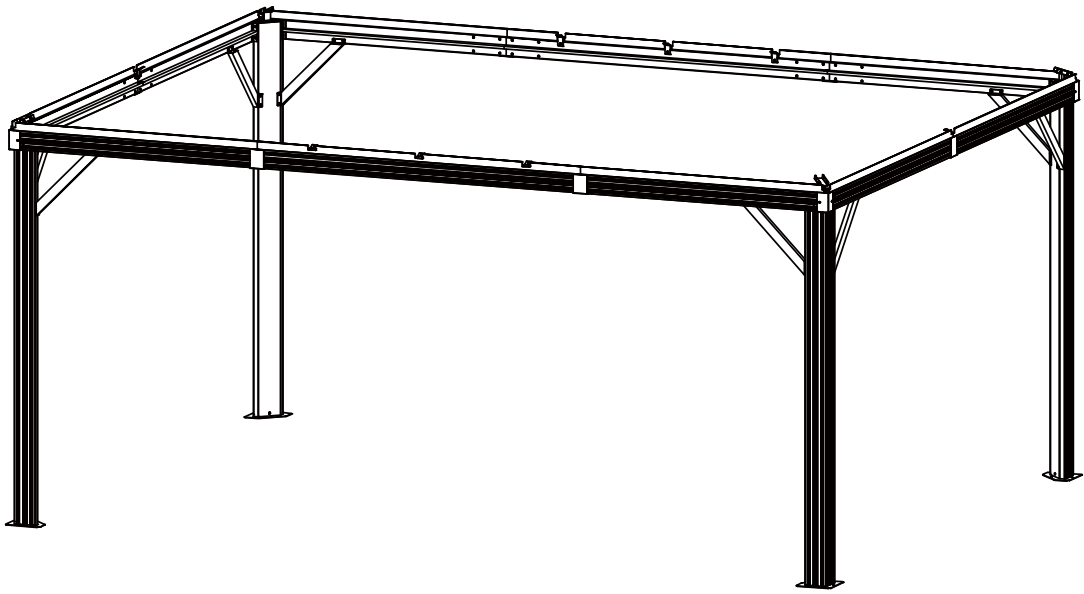

STEP 1

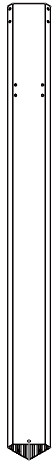

A x4

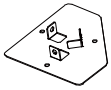

HD1 x4



HD4 x4

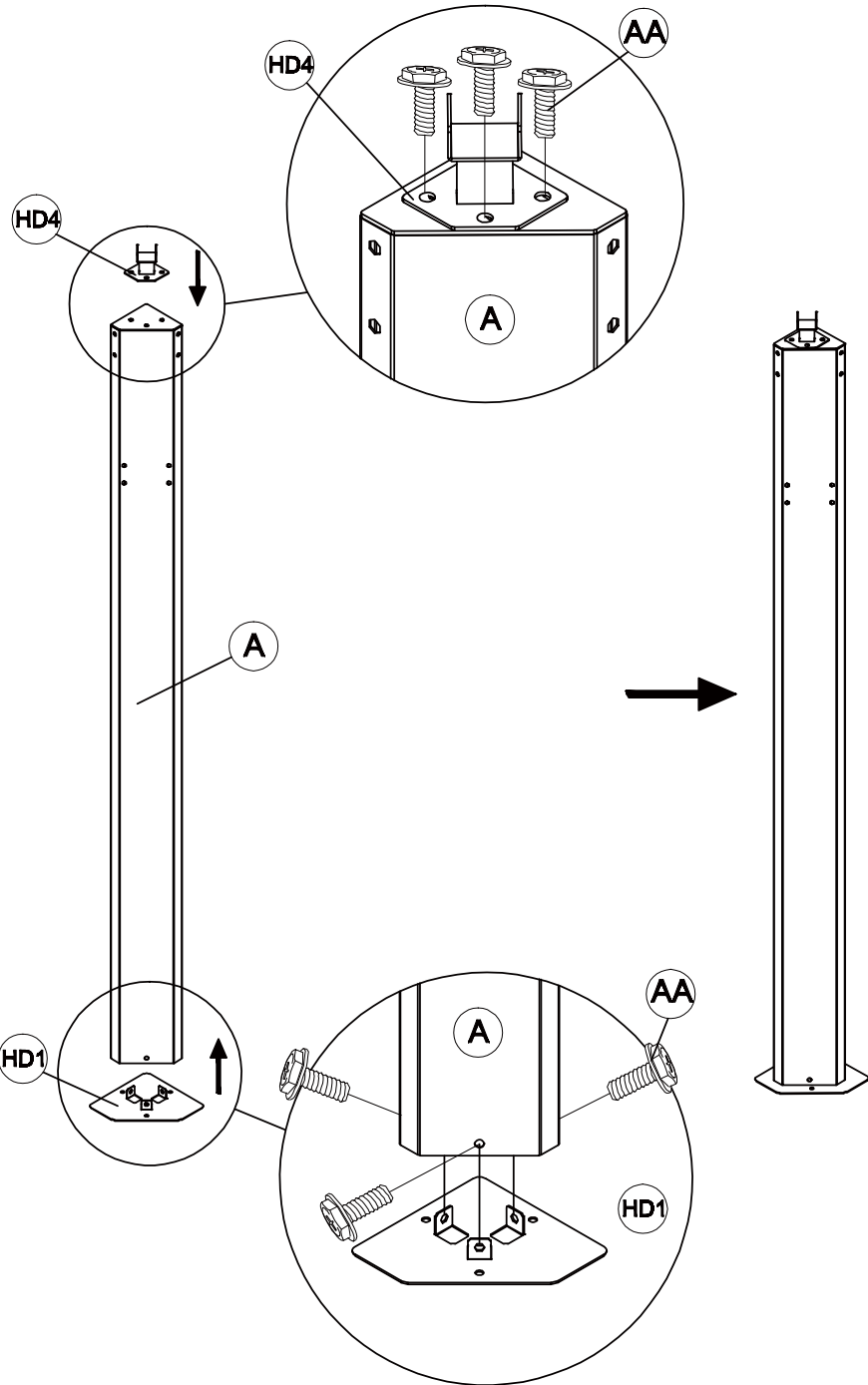

STEP1-1

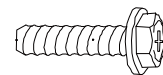

AA x24



U x2

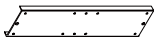

HD2 x4

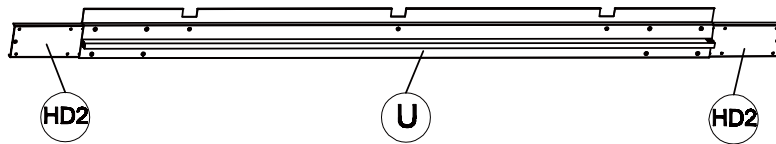
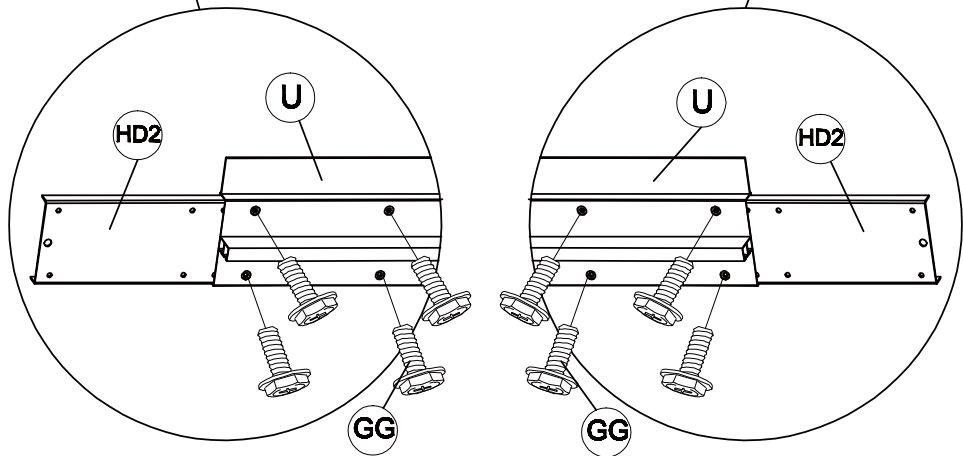
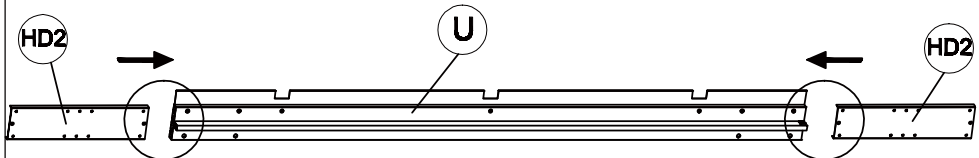

STEP1-2



GG x16

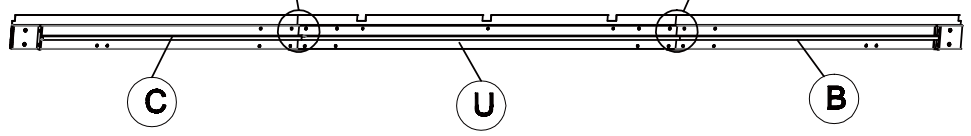
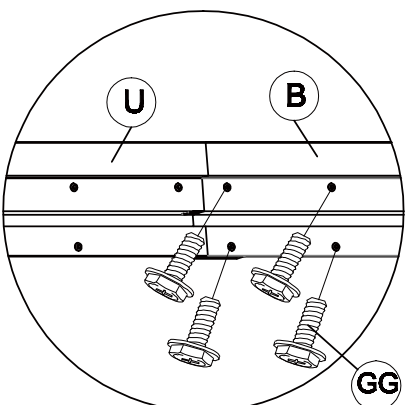
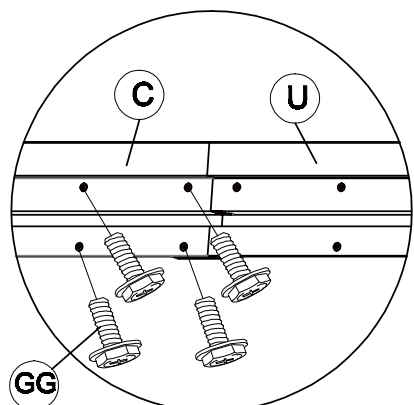
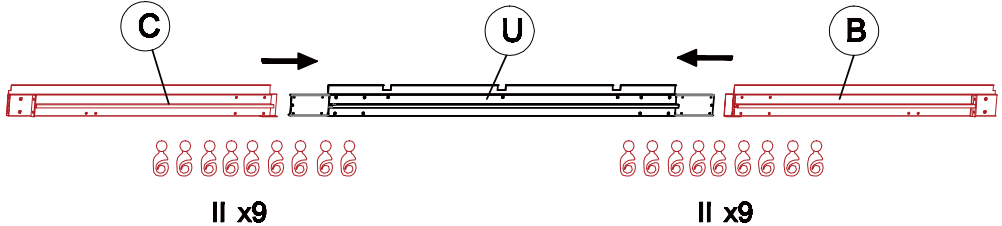
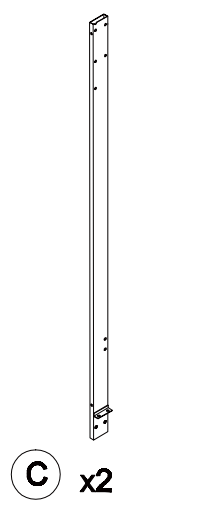
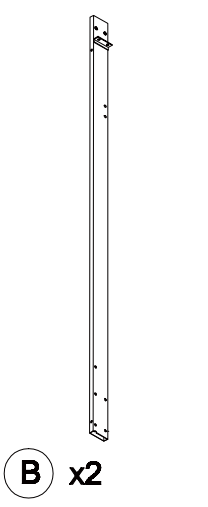

STEP1-3

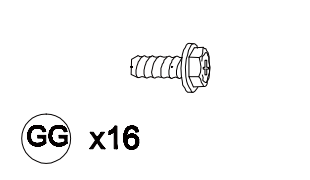
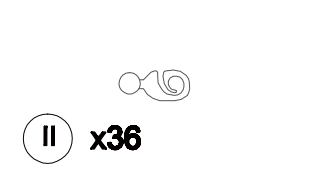

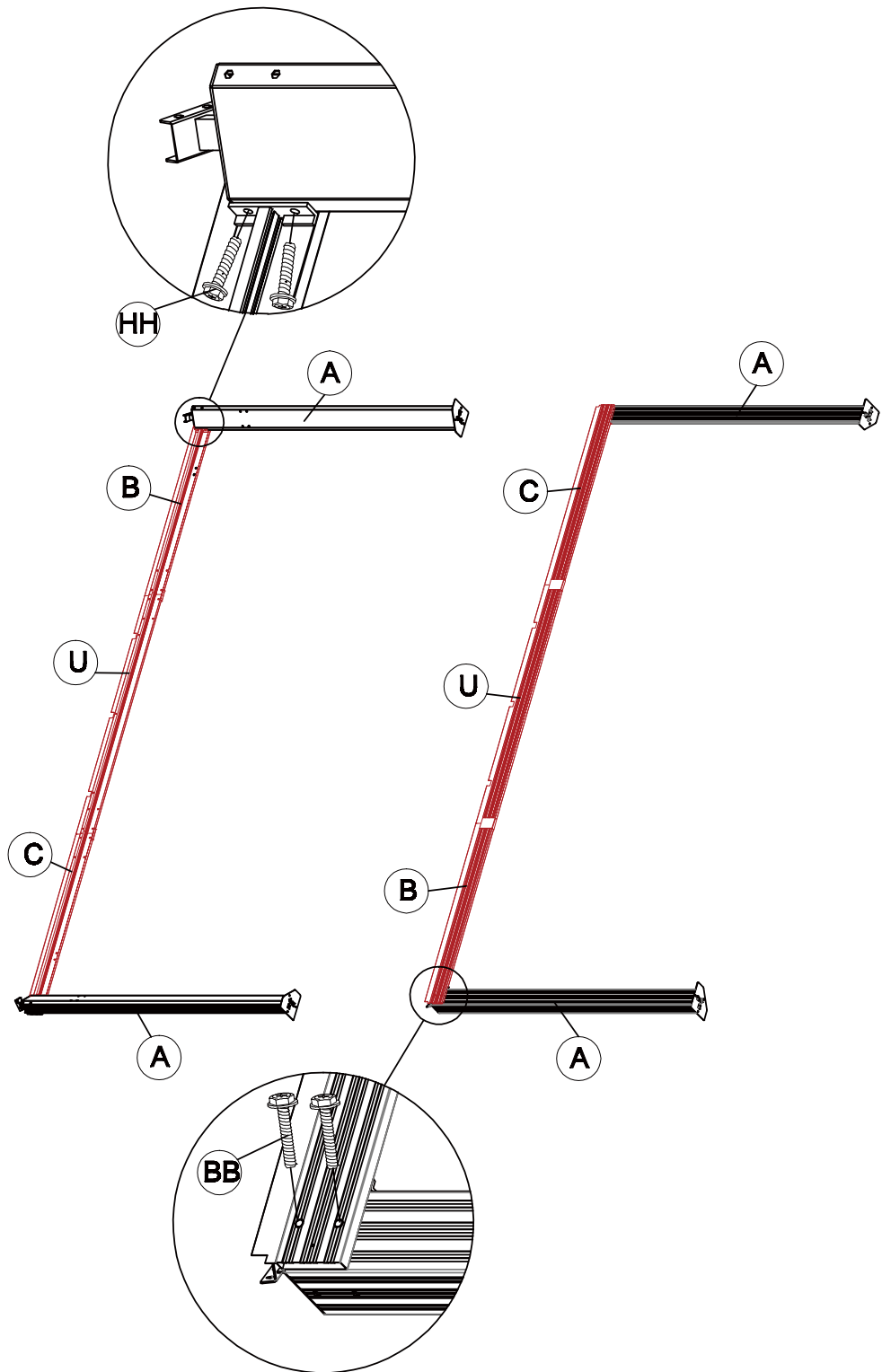

STEP1-4

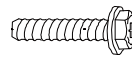

HH x8

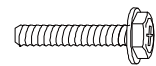

BB x8

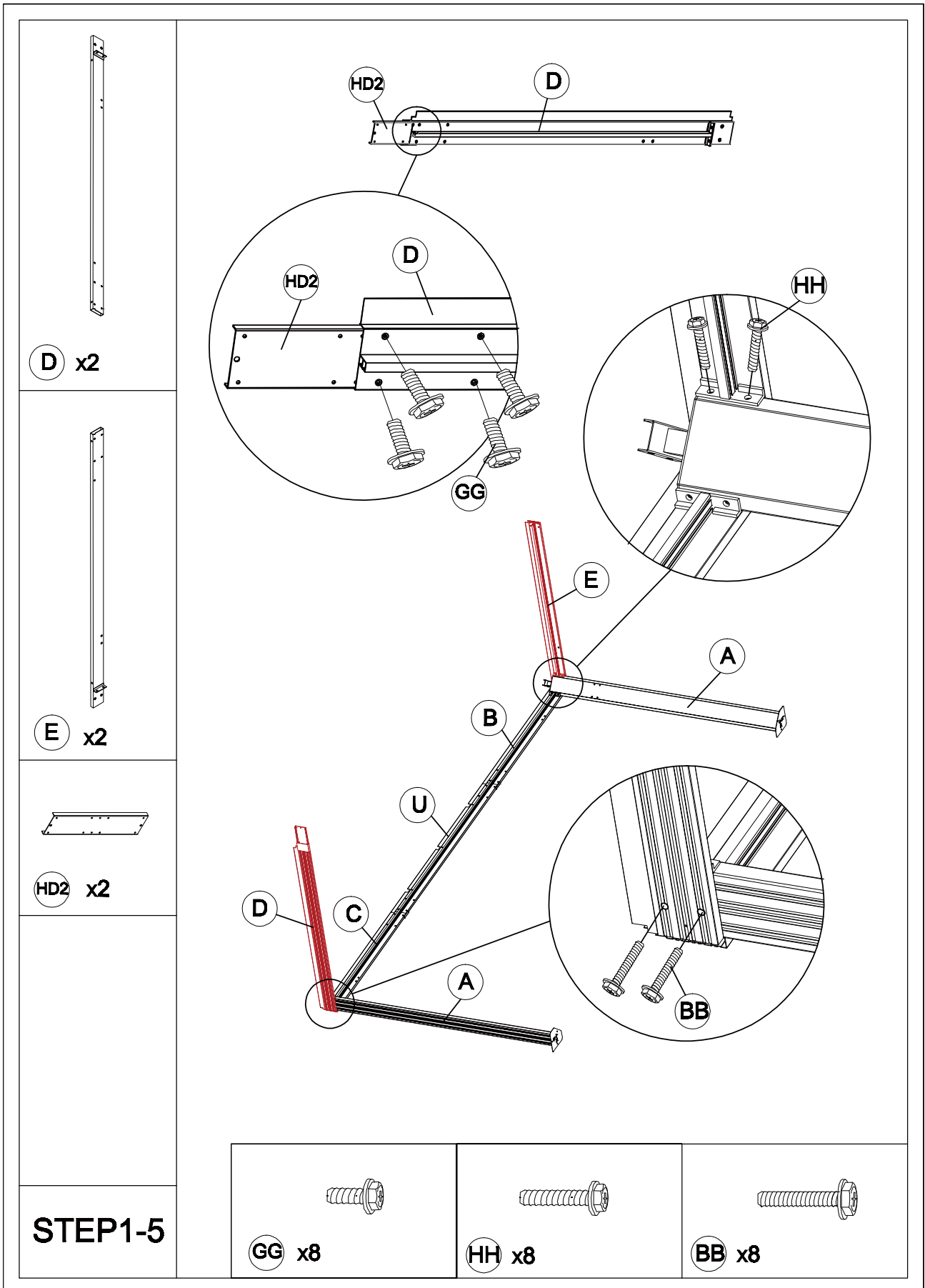

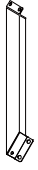

F1 x4



F2 x4

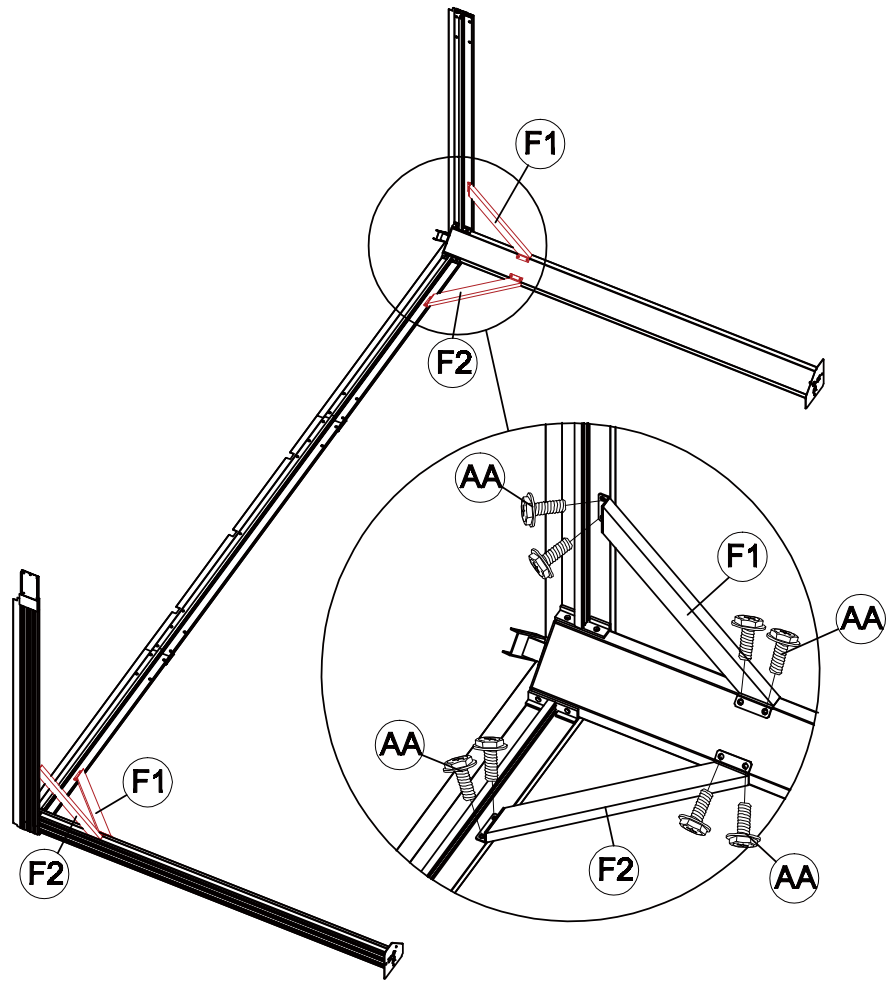

STEP1-6

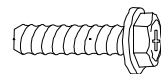

AA x32

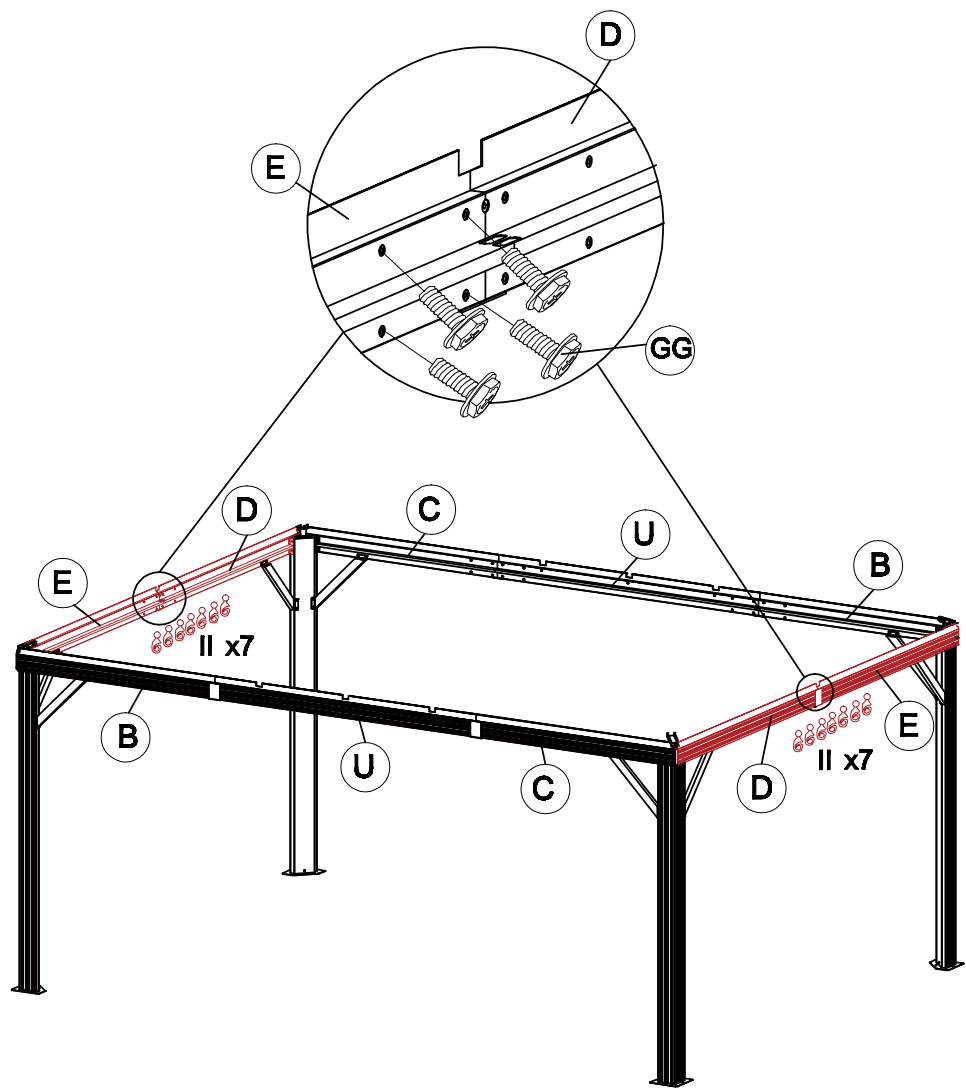

STEP1-7

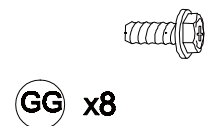
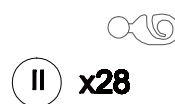

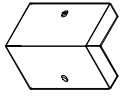

HD5 x4

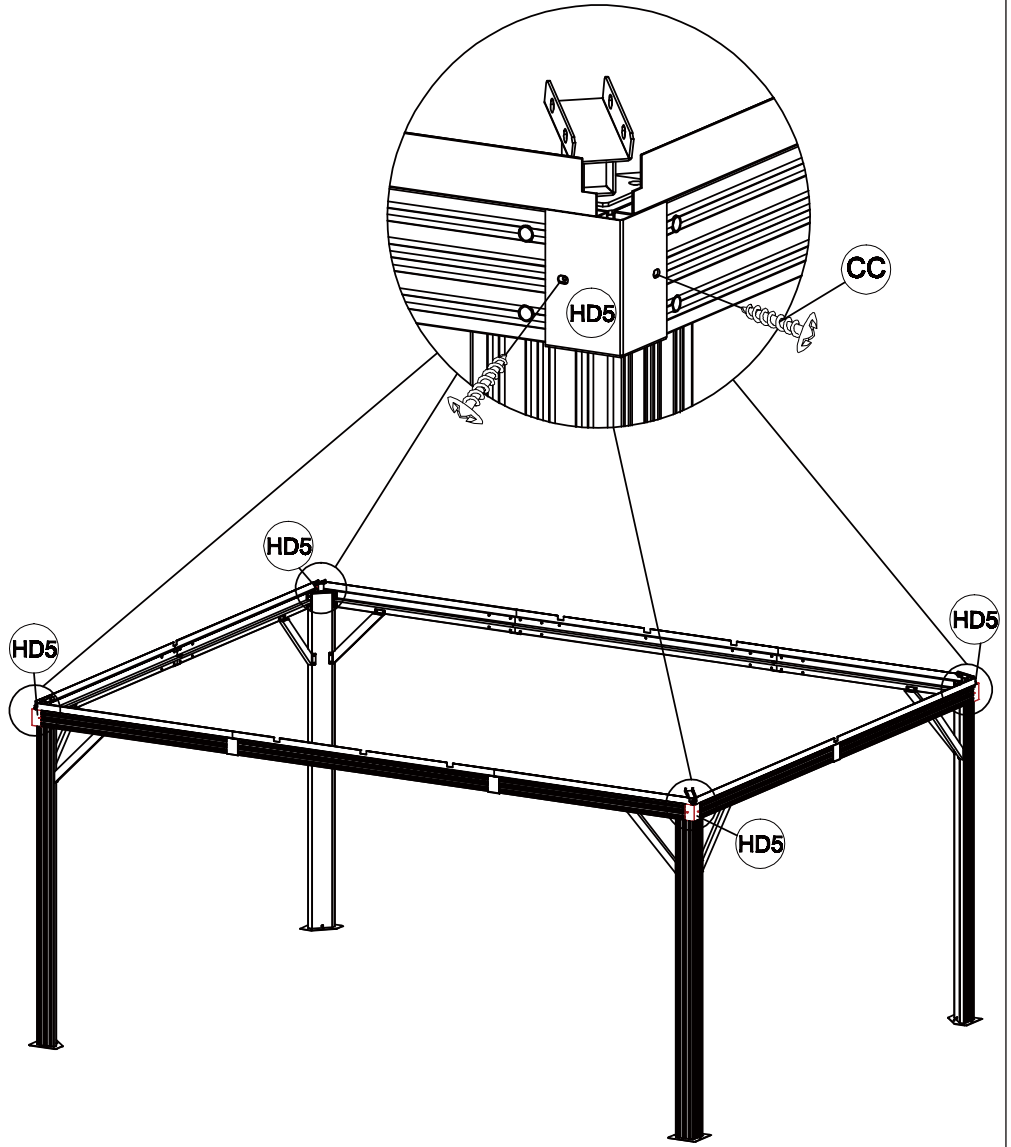

STEP1-8



CC x8



STEP 2



G1 x4

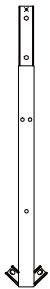

G2 x4

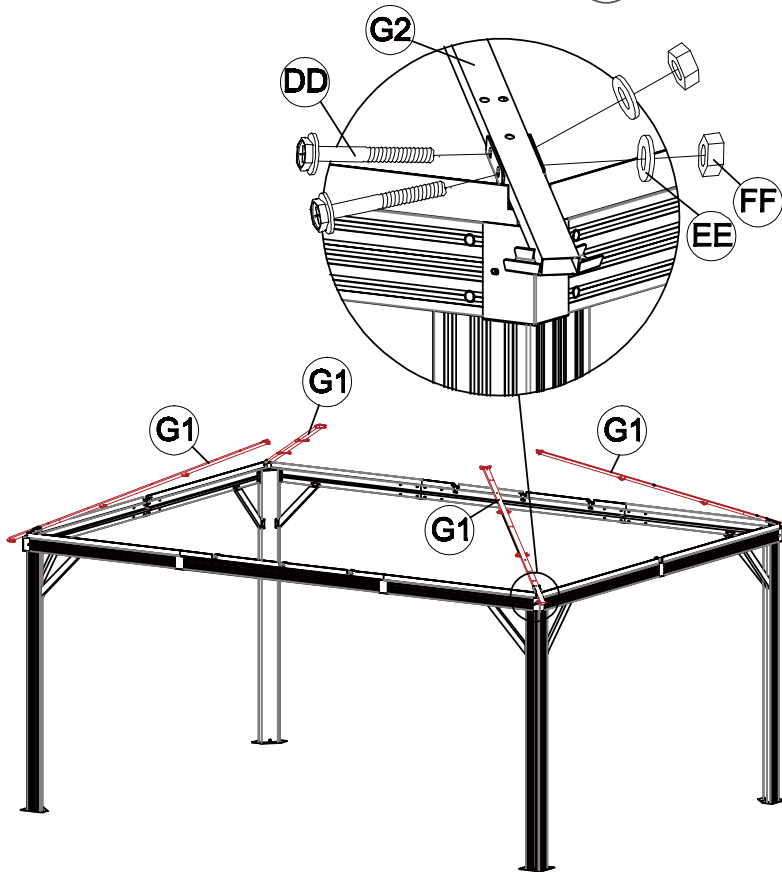
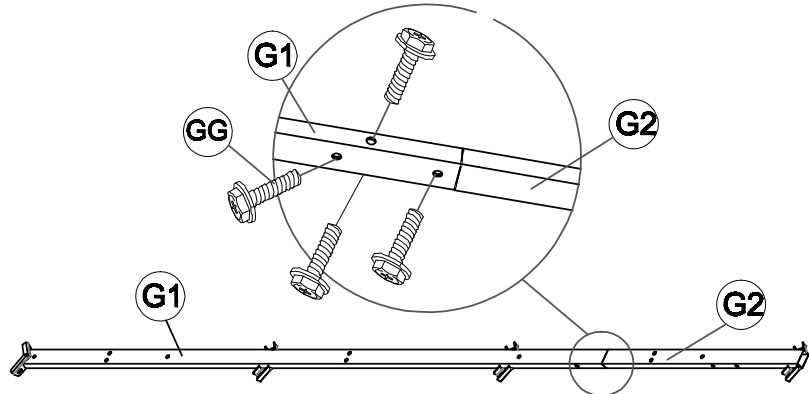
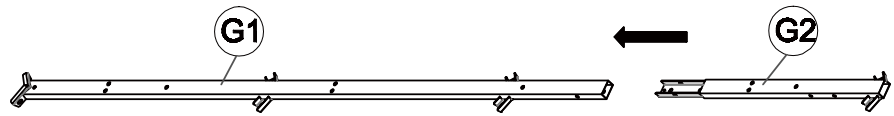

STEP2-1



FF x8



EE x8



GG x16

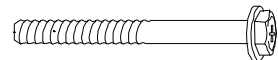

DD x8



H x2



I x2



HD12 x4

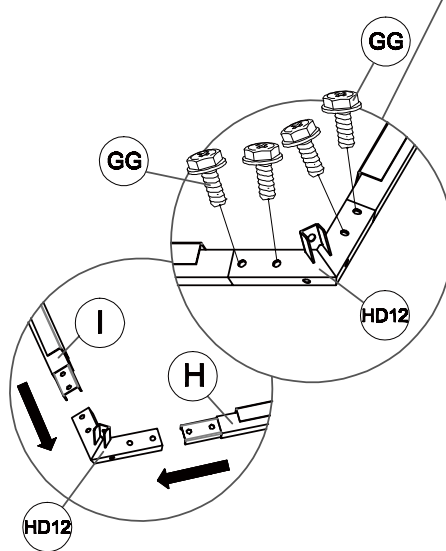
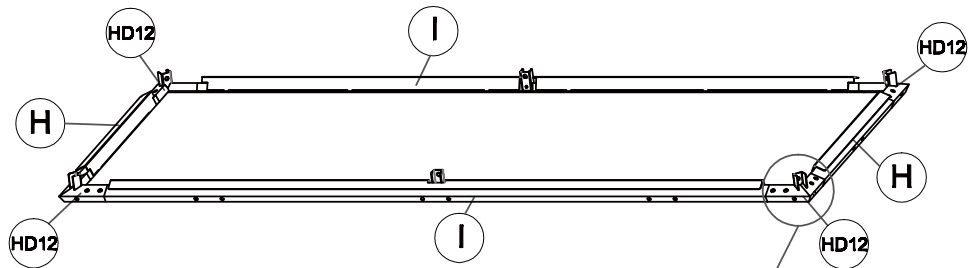

STEP2-2



GG x16

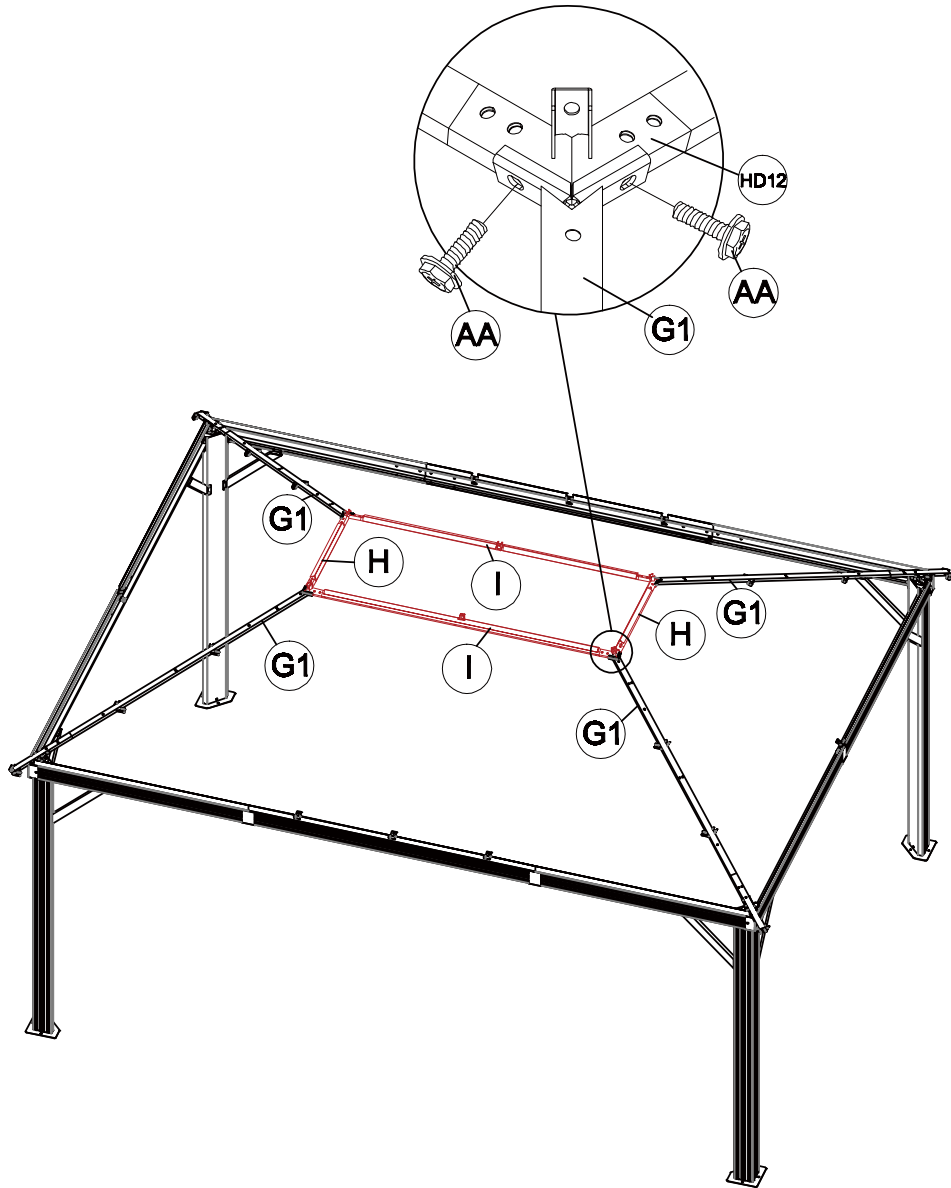

STEP2-3

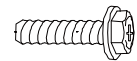

AA x8

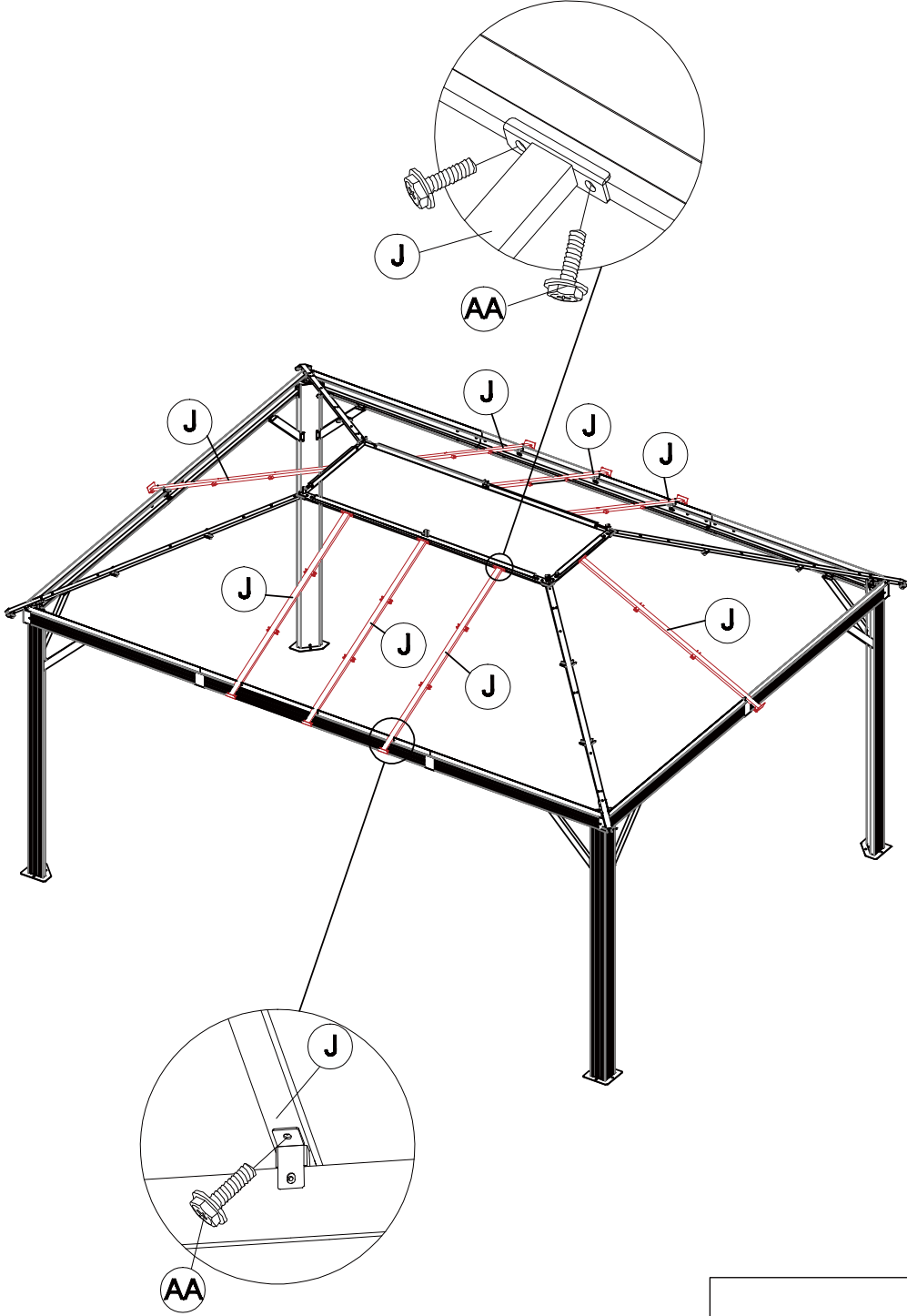
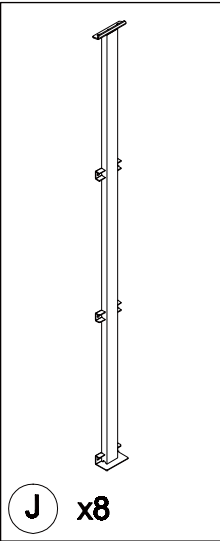

STEP2-4

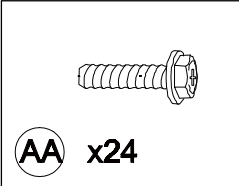



K1 x4

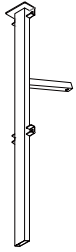

K2 x2

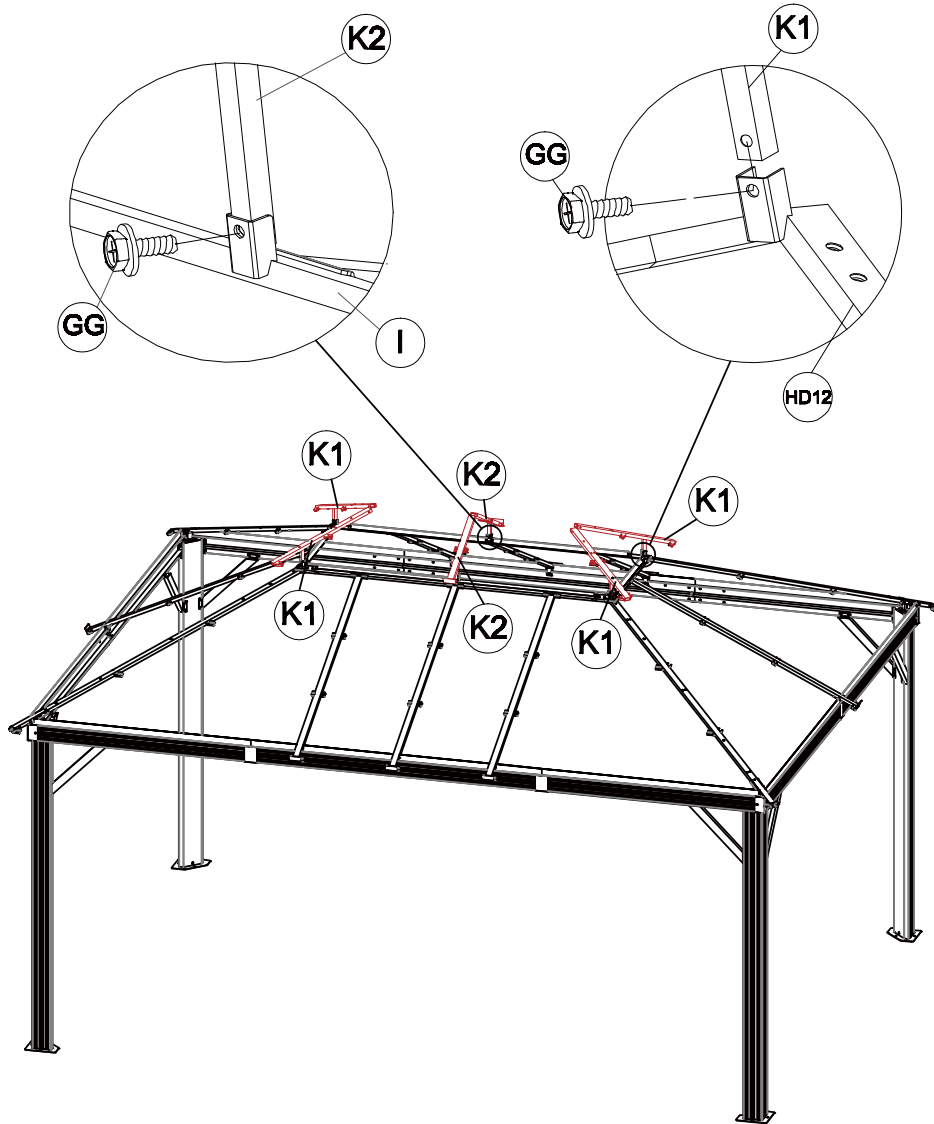

STEP2-5



GG x6

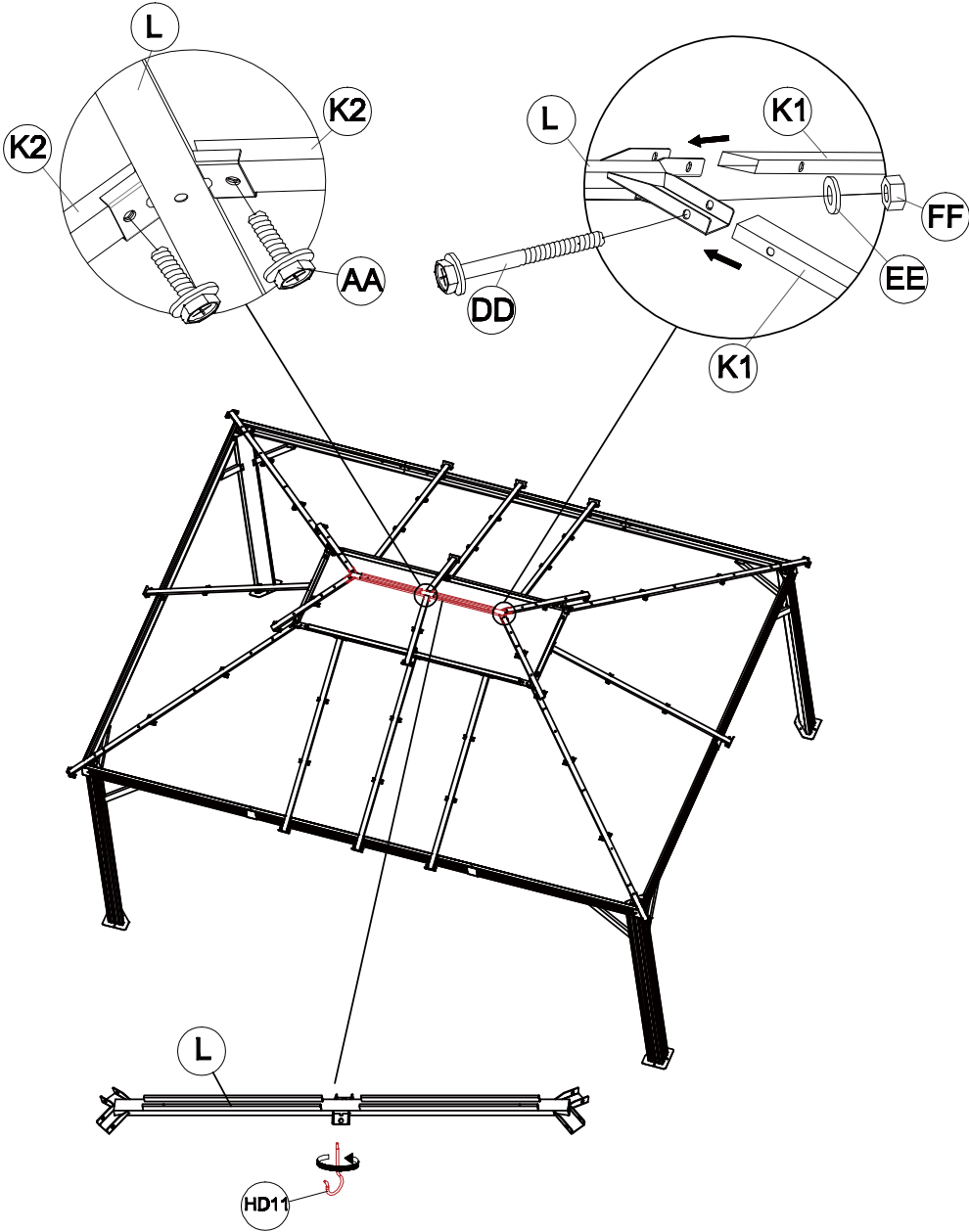
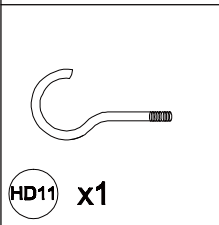
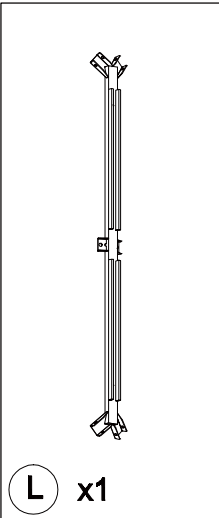

STEP2-6

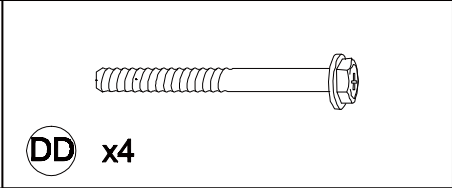
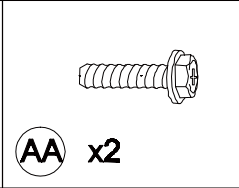
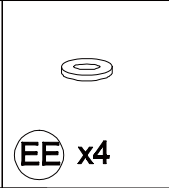
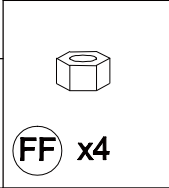

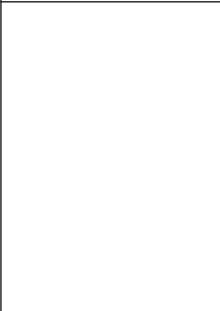
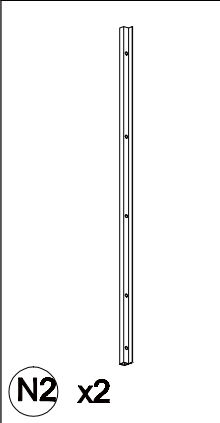
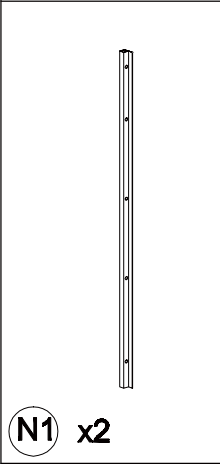
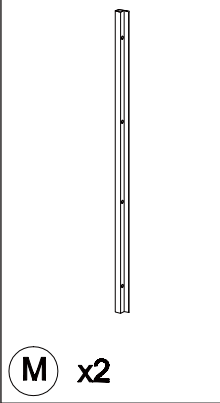

STEP2-7

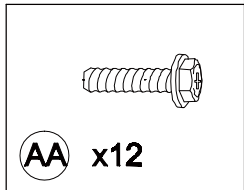
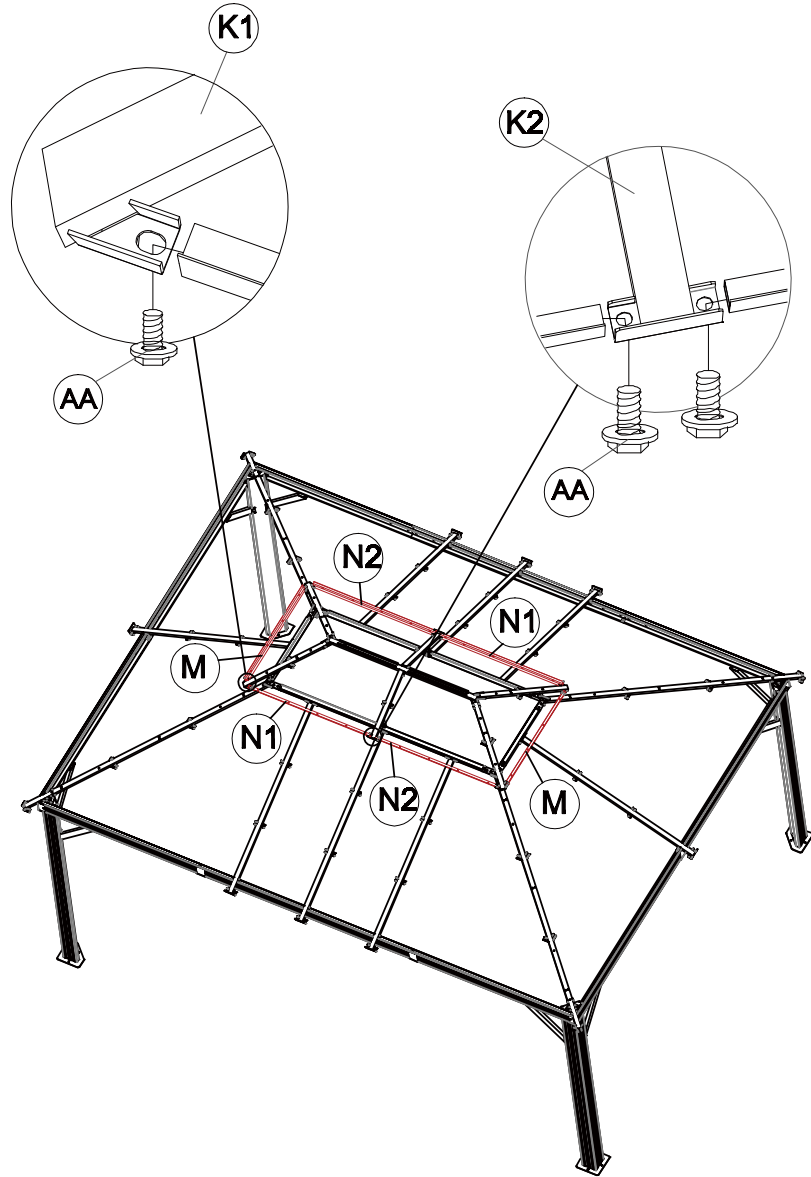



O x2



P x4

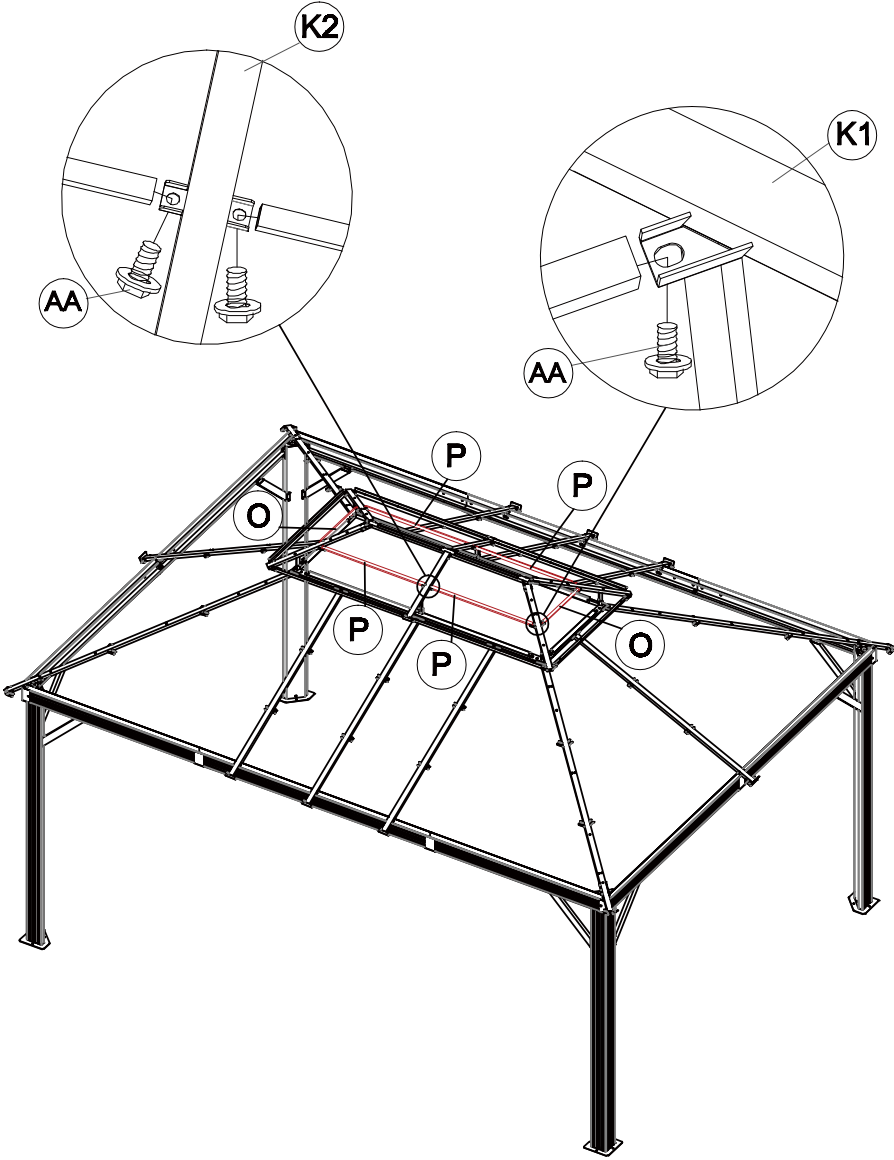

STEP2-8

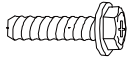

AA x12



STEP 3

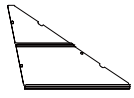

RF1 x2

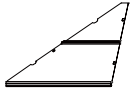

RF2 x2



RF3 x4



RF4 x2



HD6 x4

STEP3-1

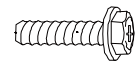
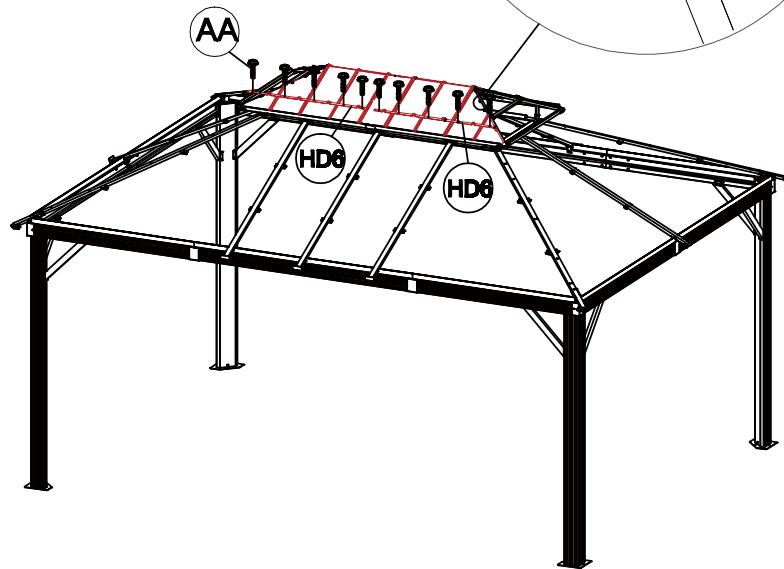
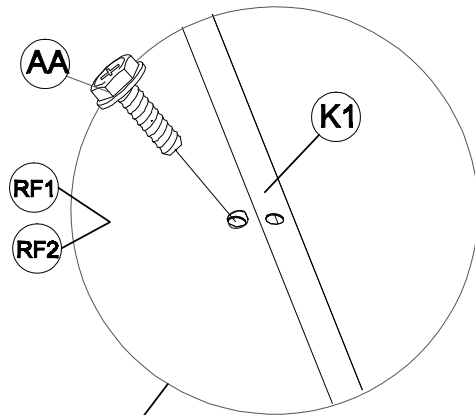
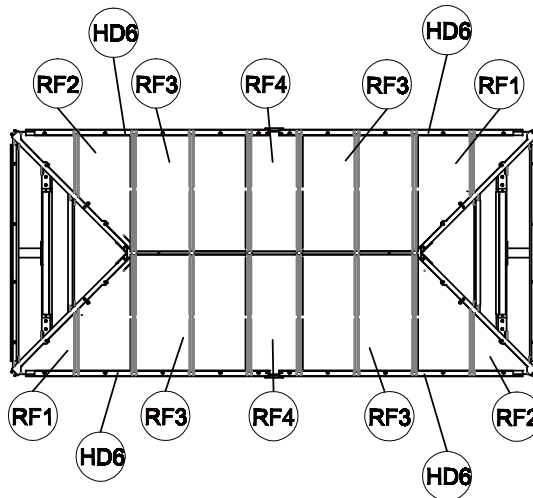

AA x24

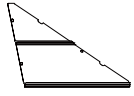

RF1 x2

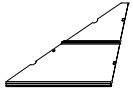

RF2 x2



HD7 x2

STEP3-2

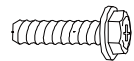
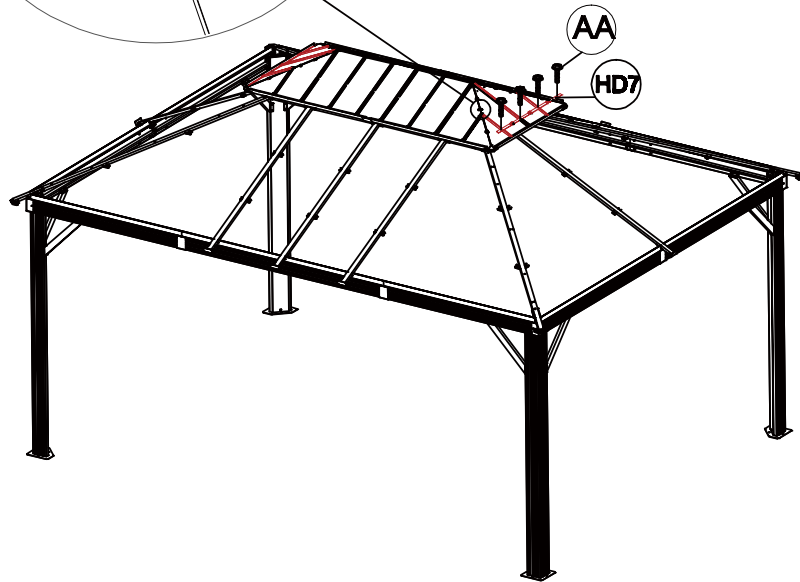
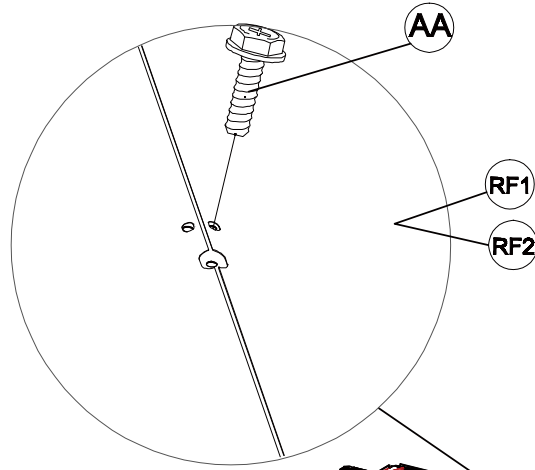
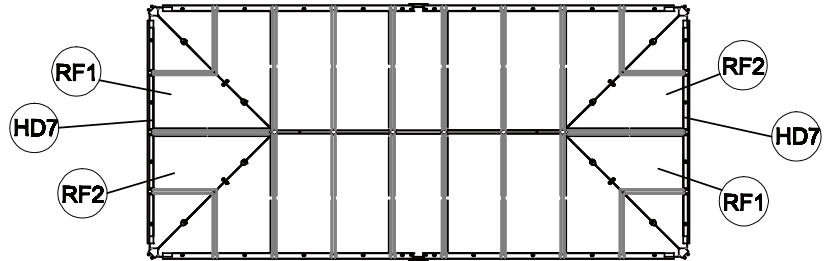

FF x12

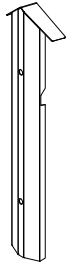

Q x4

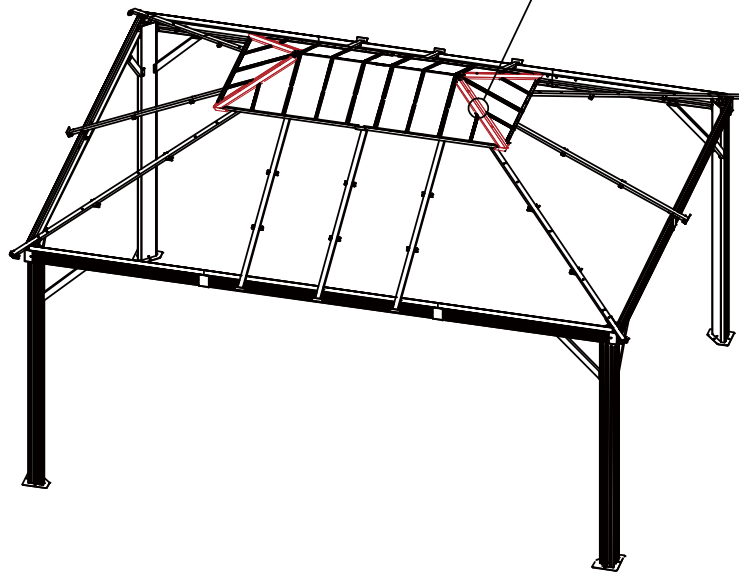
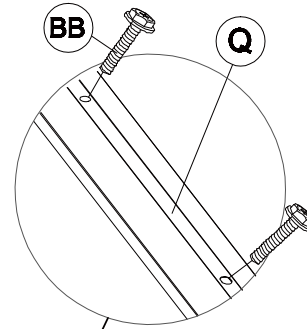

STEP3-3

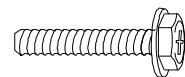

BB x8

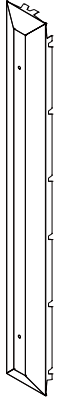

Y x1

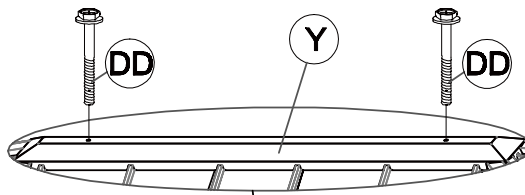

STEP3-4

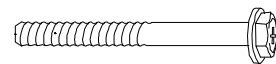

DD x2



R x8



S x8



T x8

STEP3-5

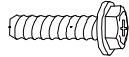
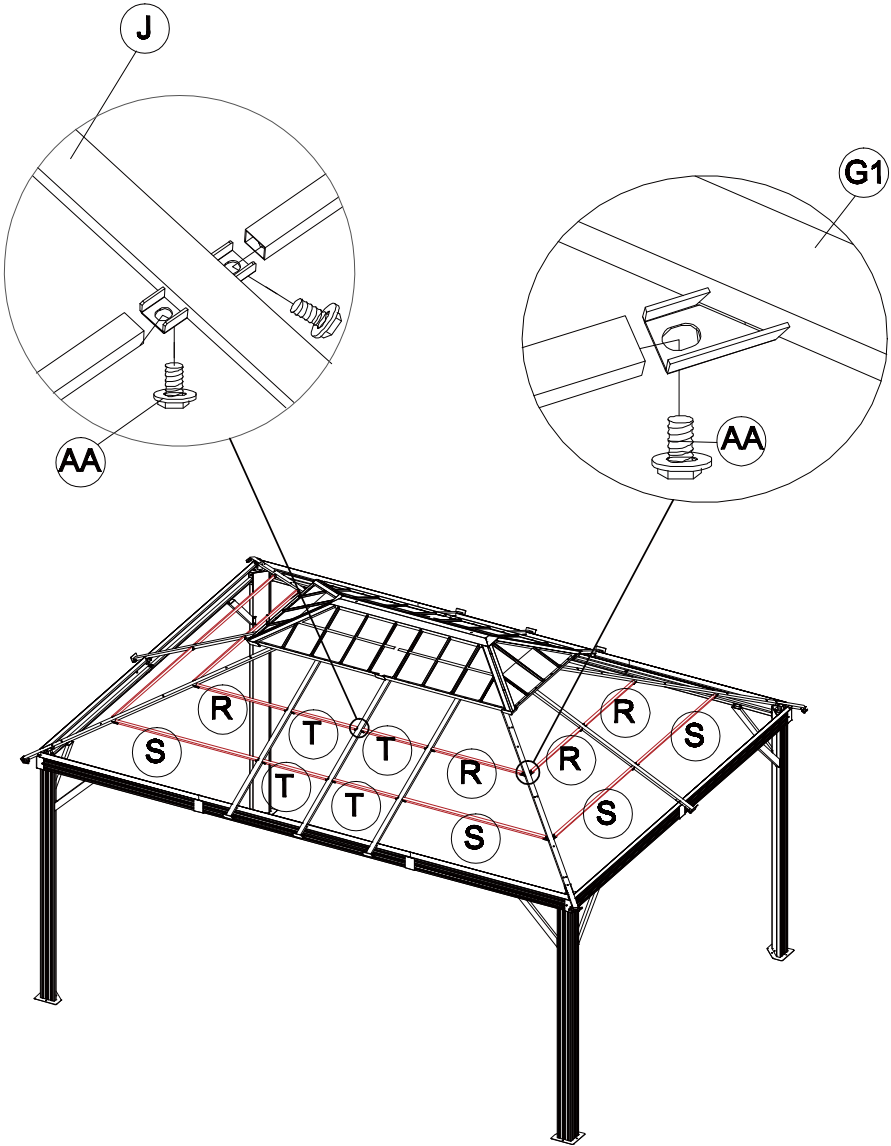

AA x48

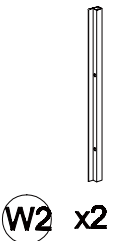
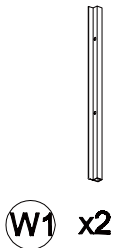
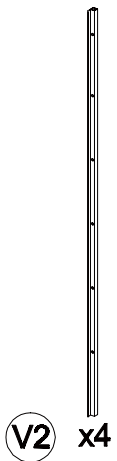
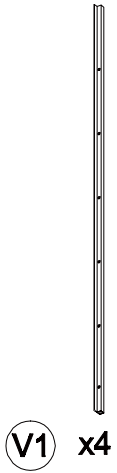

STEP3-6

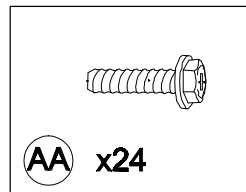
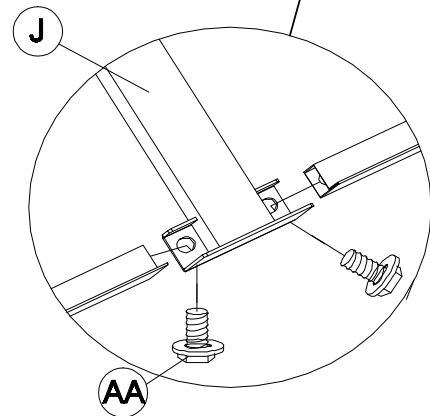
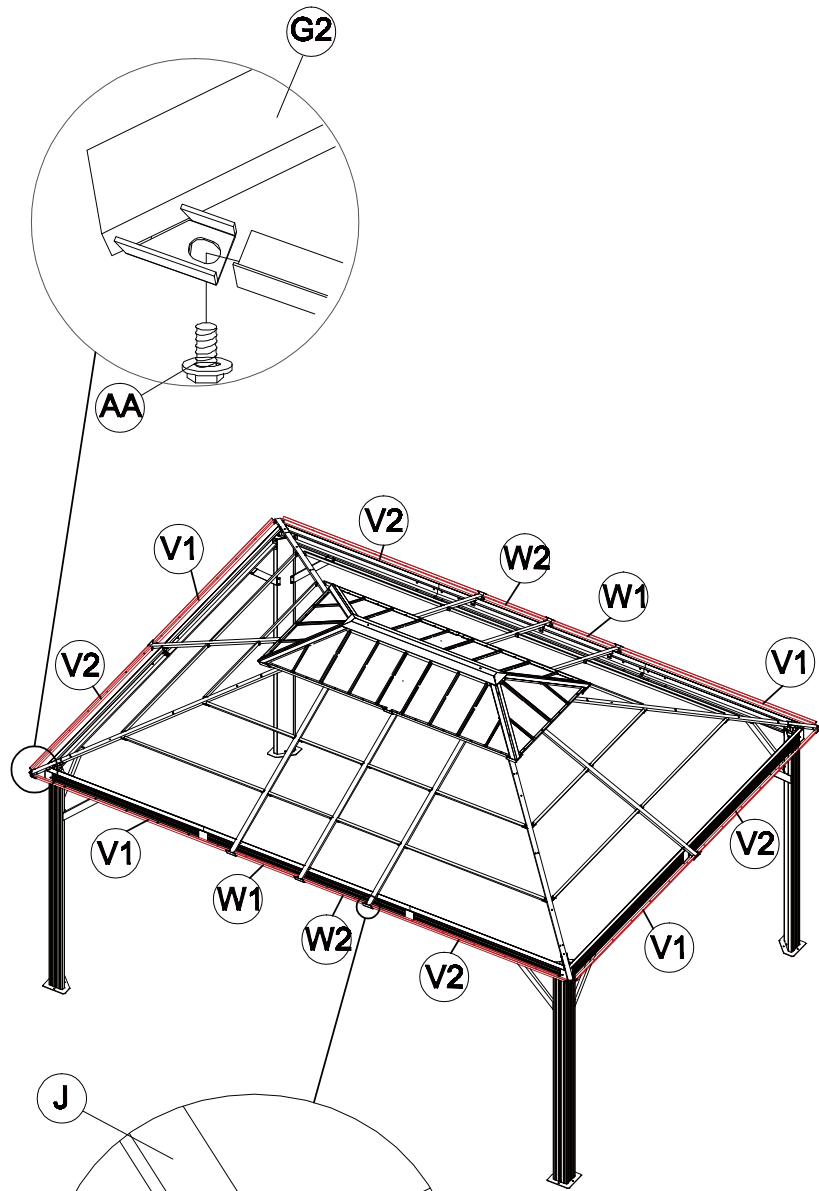

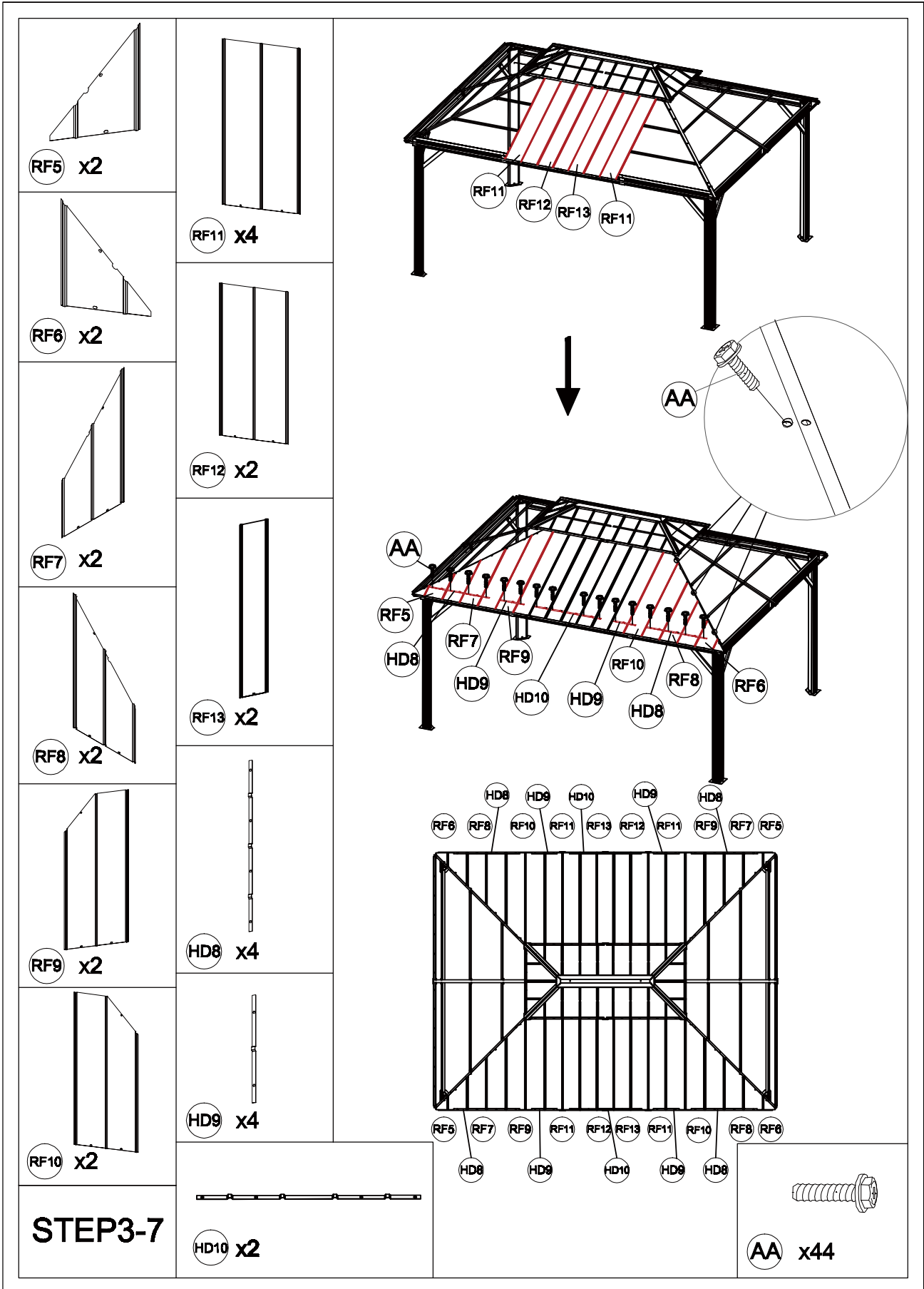

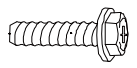
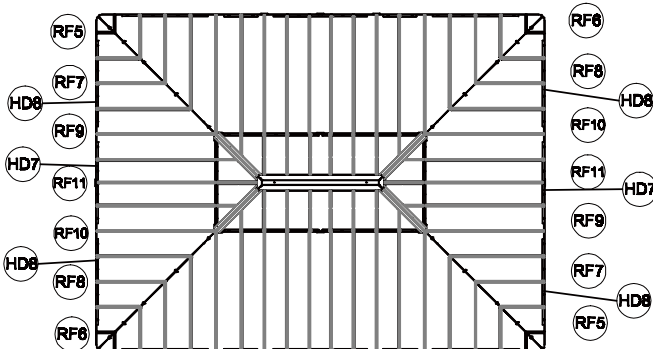
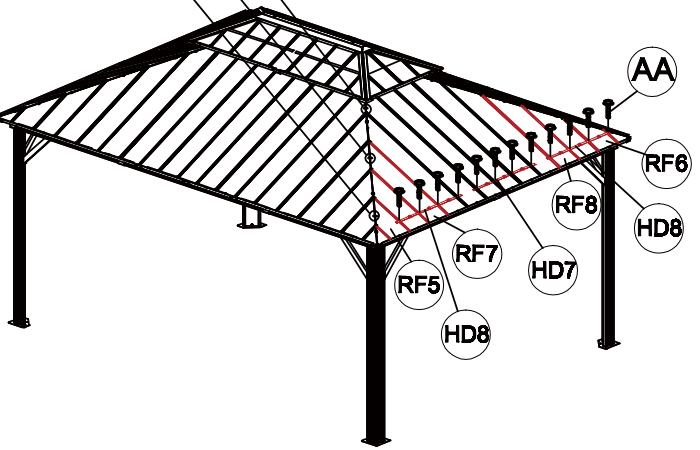
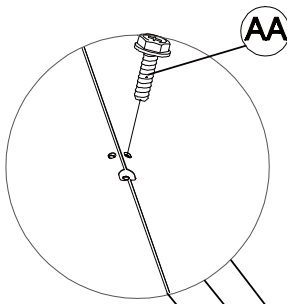
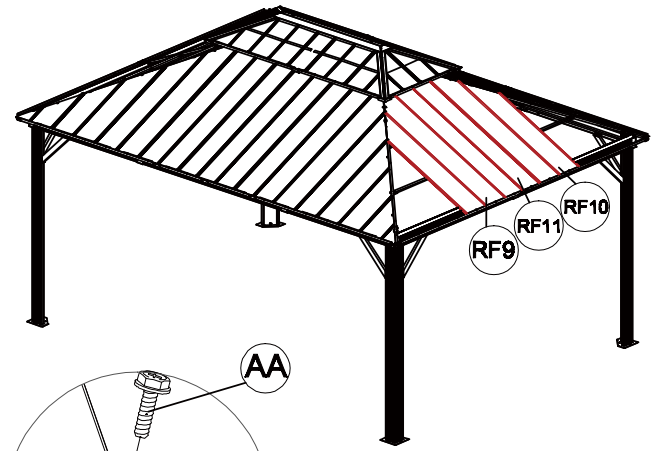
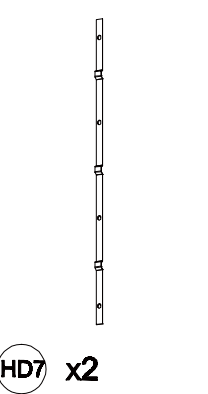
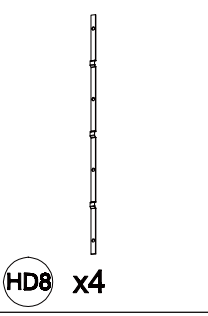
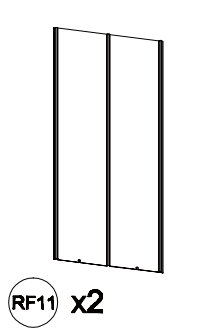
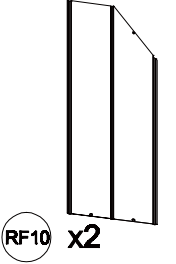
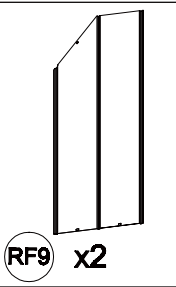
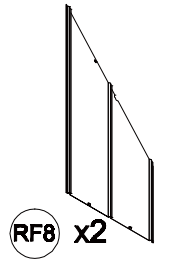
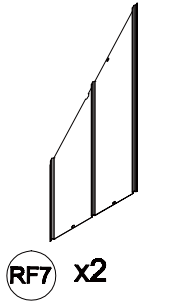
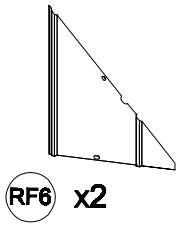
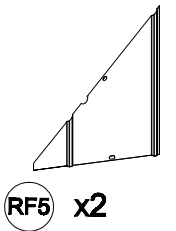

AA x36

STEP3-8



X1 x4

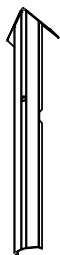

X2 x4

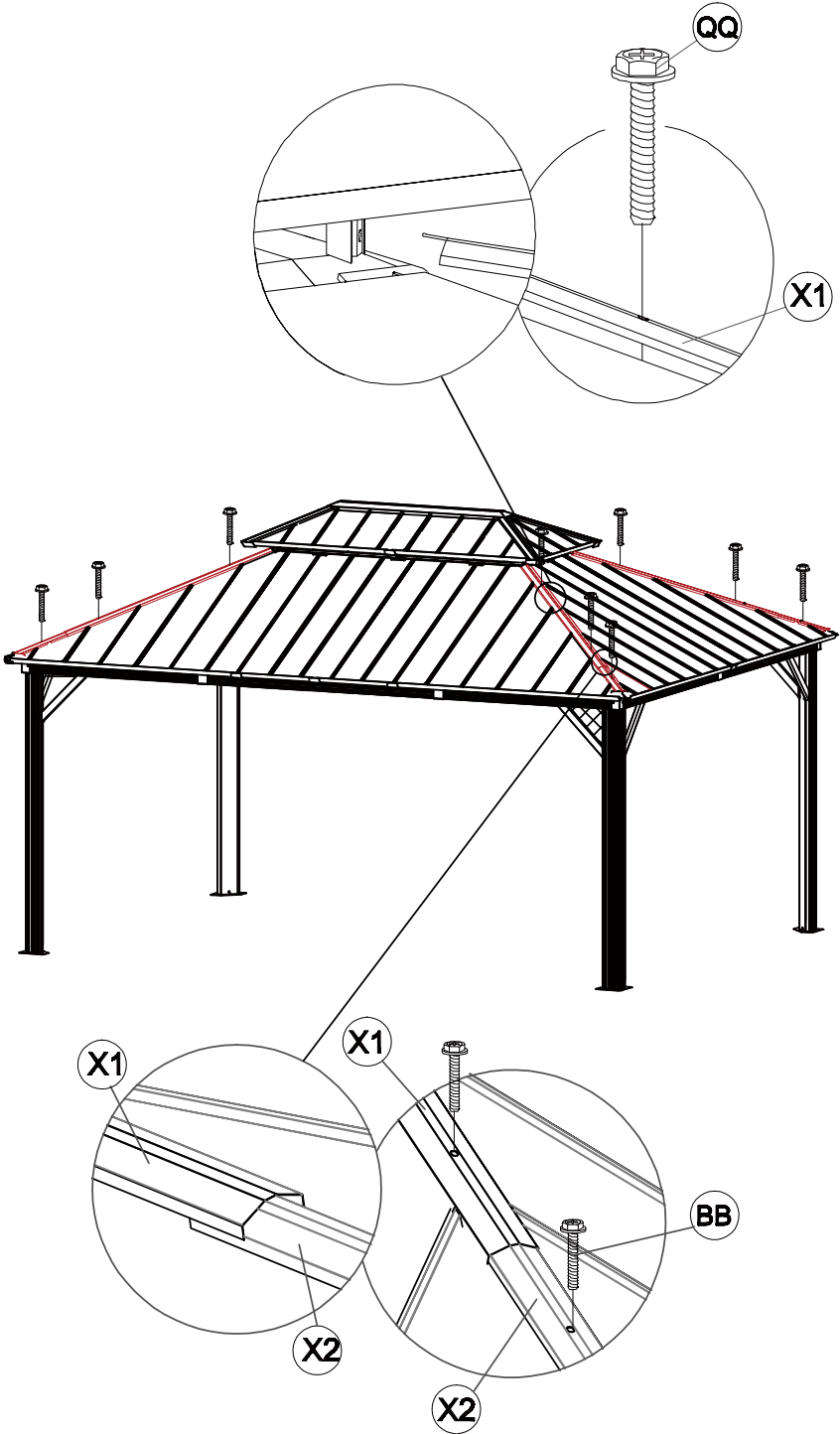

STEP3-9

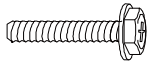

BB x12

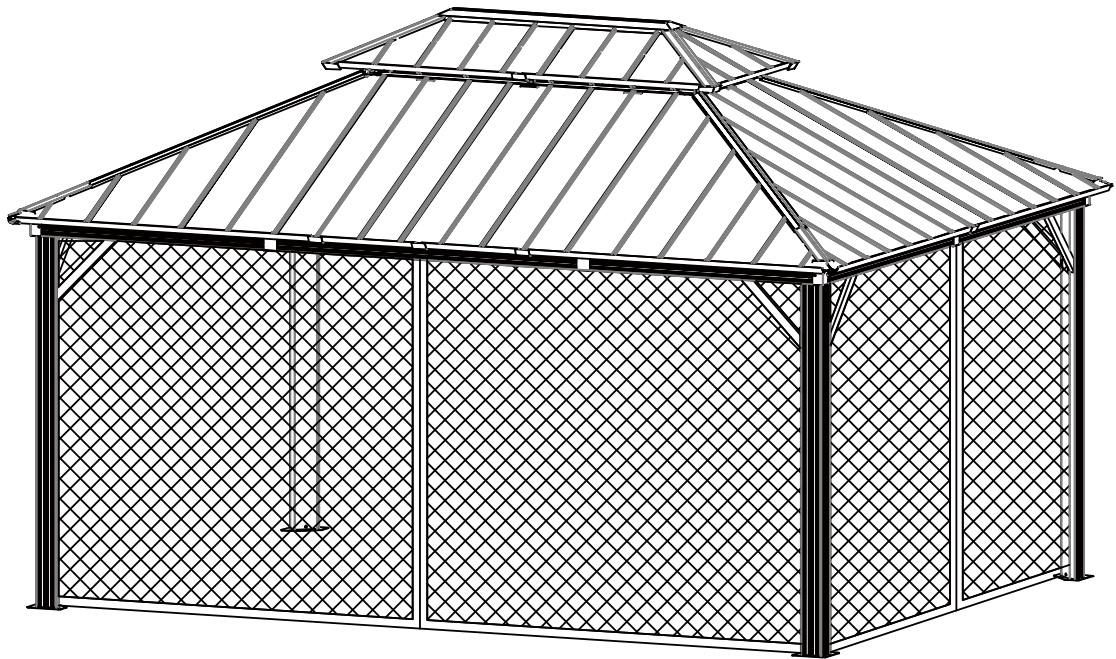

STEP 4

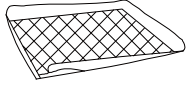

NET x1

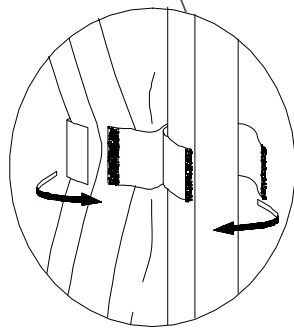
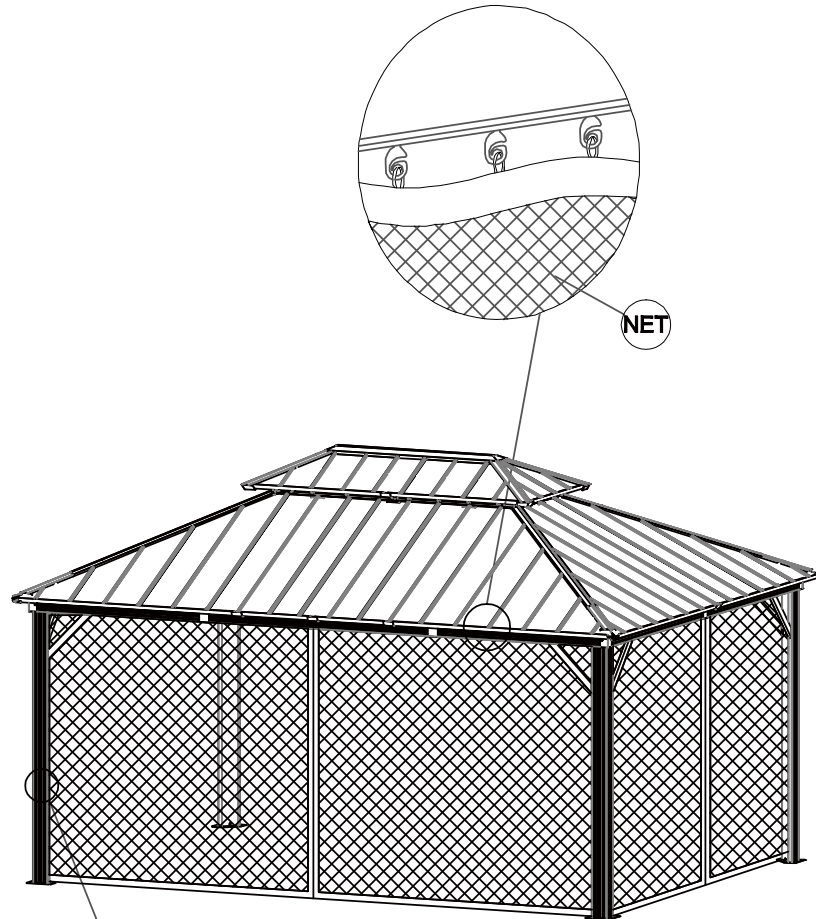

STEP4-1

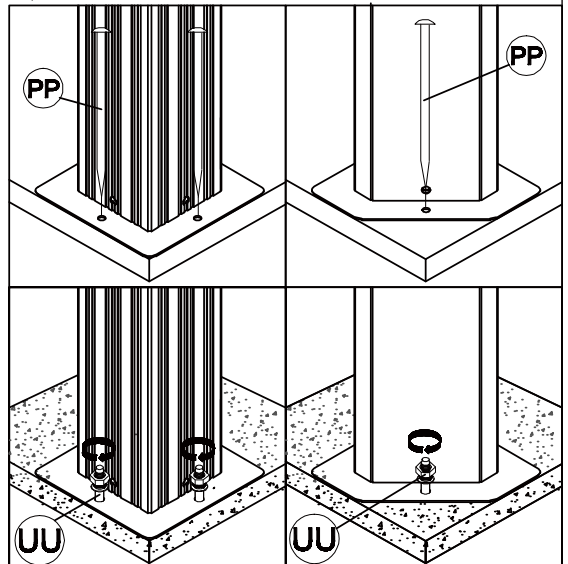
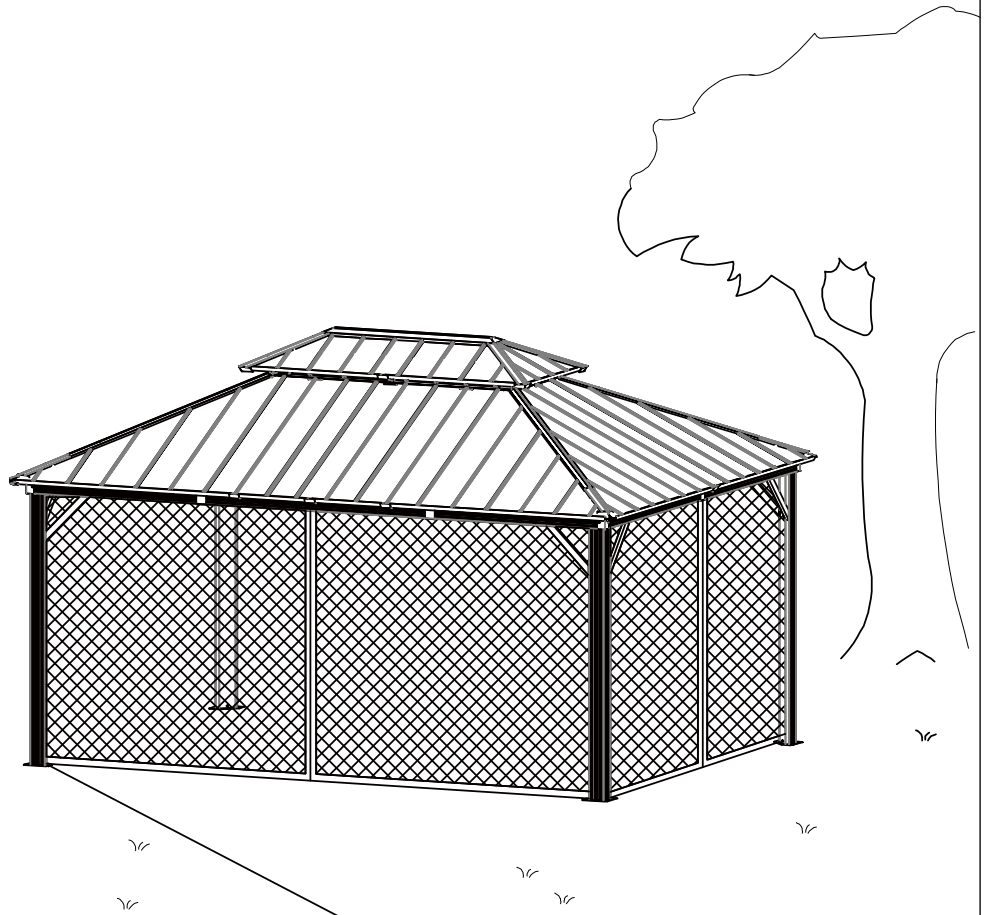

STEP4-2

UU x12

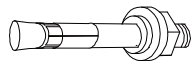

PP x12

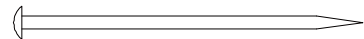

Care and Cleaning

- Wash frame parts and fabric with mild soap and water, rinse thoroughly.
- Dry the frame completely and allow the fabric to drip dry.
- Do not use bleach, acid, or other solvents on the fabric or frame parts.
- Please inspect and tighten all bolts or fasteners on a regular basis to ensure the proper performance and safety of your gazebo.

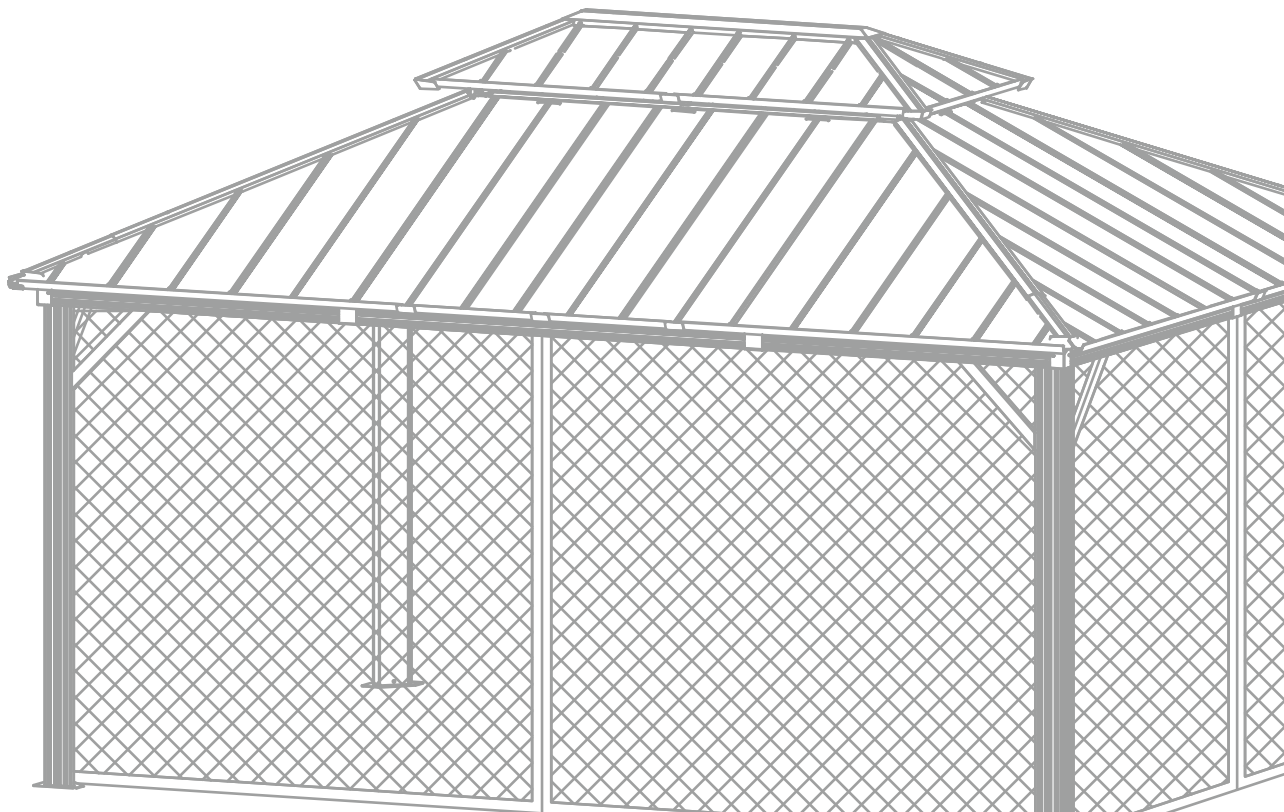

Warranty

One Year Warranty

Frames

Frames constructions are warranted to be free from defects in material and workmanship for 1 year from item purchased. Damage to frame from negligence won't be covered by this warranty.

Bolts & nuts

Bolts and nuts are warranted to be free from defects in material and workmanship for 1 year from item purchased. Damage from exposure to chemicals (including not only oils ,spills, fluids) won't be covered by this warranty.

Curtains & Netting

Curtains and netting are warranted to be free from defects in material and workmanship for 1 year from item purchased. Damage from exposure to chemicals (including but not only oils, spills, fluids) won't be covered by this warranty.

Warranty Limitation

This warranty is for the original purchase order only. (Order number required). This warranty is non-transferable. Olilawn is responsible for the free replacement part including shipping charges for the 1 year warranty.

Warranty Exclusion

This warranty does not cover products subject to negligence, abuse usage, inappropriate installation, extreme weather condition. Olilawn reserves the right to explain warranty exclusions. When the replacement item is applied, the 1 year warranty automatically expires. Please feel free to contact us for applying warranty.



 **Website**
www.oilawn.com

 **Contact**
support@oilawn.com

 **Address**
Room 1003, No.209, Baoyuan Road, Baoan District, Shenzhen

 **Copyright**
Copyright © Shenzhen Xinfeng Innovation Technology Co., Limited

