

Remote by Simon James



SIMON JAMES

SIMON JAMES

The Remote collection is an enclosed, standalone desking system that offers privacy and modularity. Remote's angular grid structure minimises parts and ensures floorspace is utilised fully, while timber components add warmth and character.

The Remote collection comes in three ranges - an extendable pod, a single desk and a duo desk, with up to three extensions. All Remote products include seamless integrated soft-wiring to cater for agile usage.

Made in New Zealand



Mist



Natural
Oak

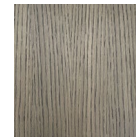

Smoked
Oak

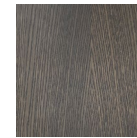

Dark
Almond

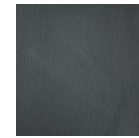

Black

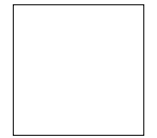

White HPL

Remote Desk and Leaner Top Dimensions

SIMON JAMES

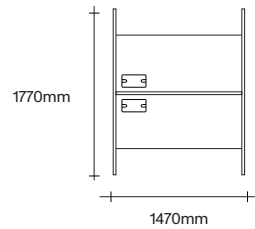

Duo

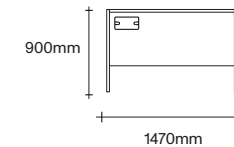

Single

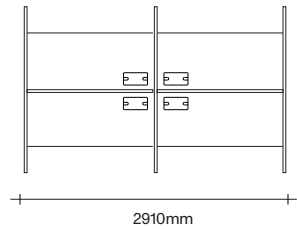

Duo with Extension

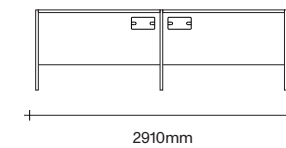

Single with Extension

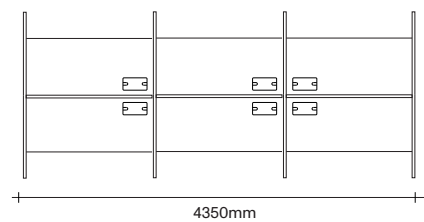

Duo with 2 Extensions

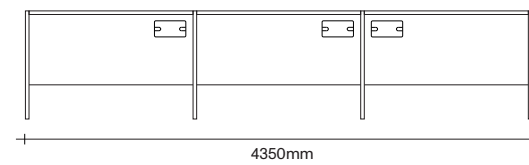

Single with 2 Extensions

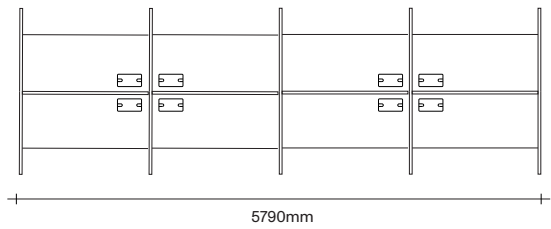

Duo with 3 Extensions

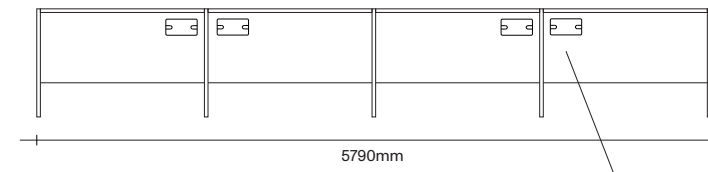

Single with 3 Extensions

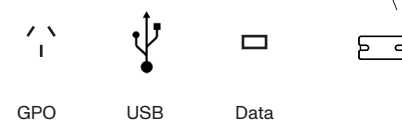

GPO

USB

Data

Softwiring Options

Remote Desk, Leaner and Pod Dimensions

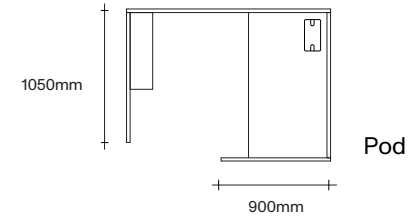
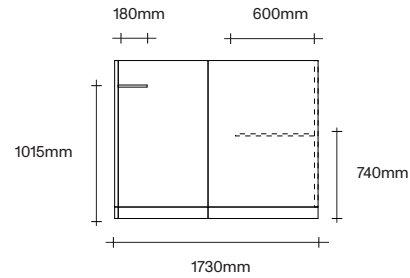
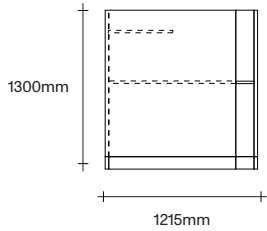
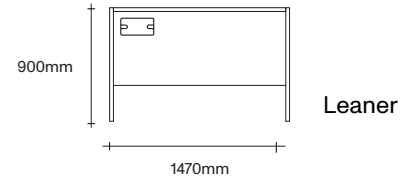
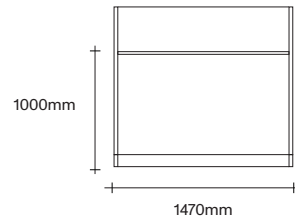
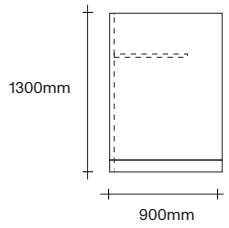
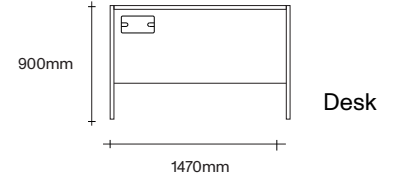
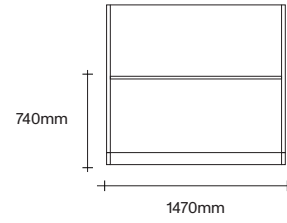
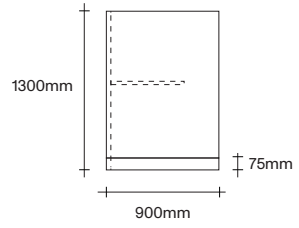

SIMON JAMES

SIMON JAMES

Remote Desking Possible Configurations

Desk Duo
with Extension

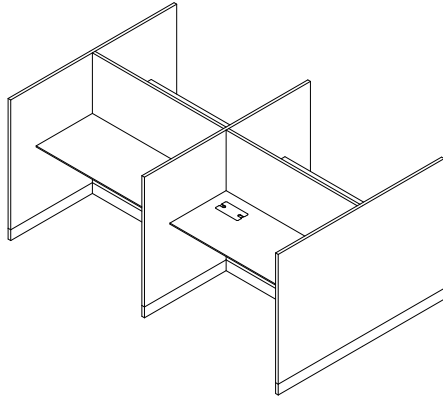

Single Desk

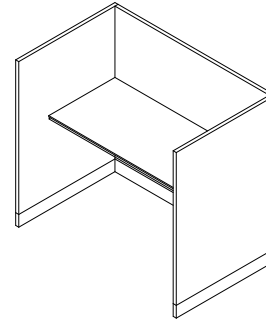

Desk Single
with 3 Extensions

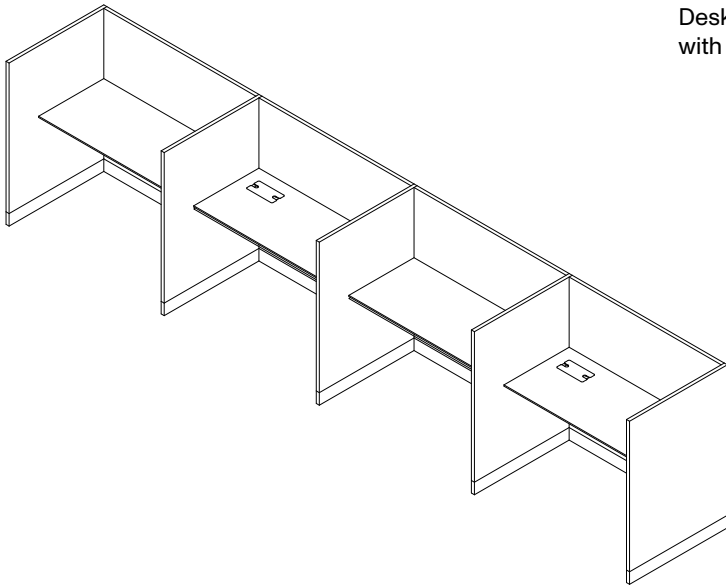

Desk Duo
with 2 Extensions

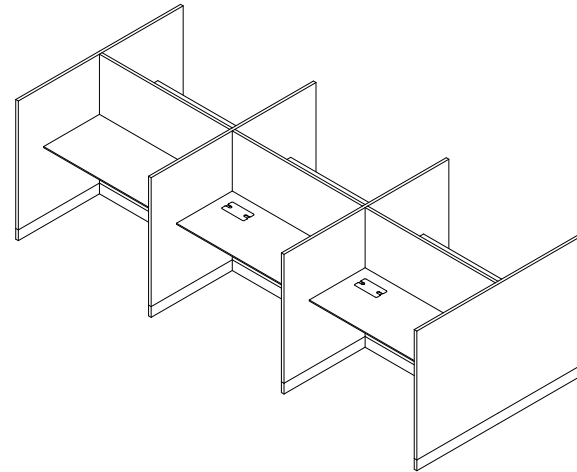

SIMON JAMES

Remote Pod Possible Configurations

Single Pod
Left

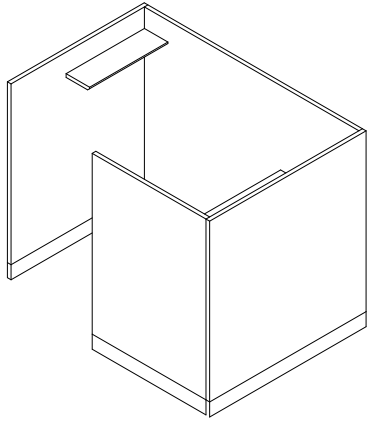

Single Pod
Right

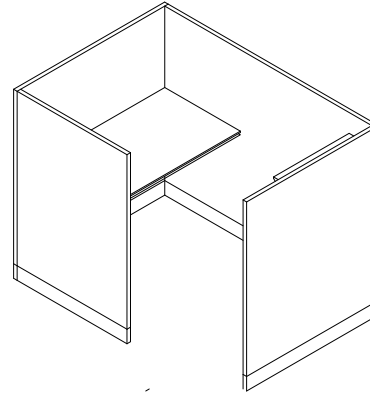

Pod Quad

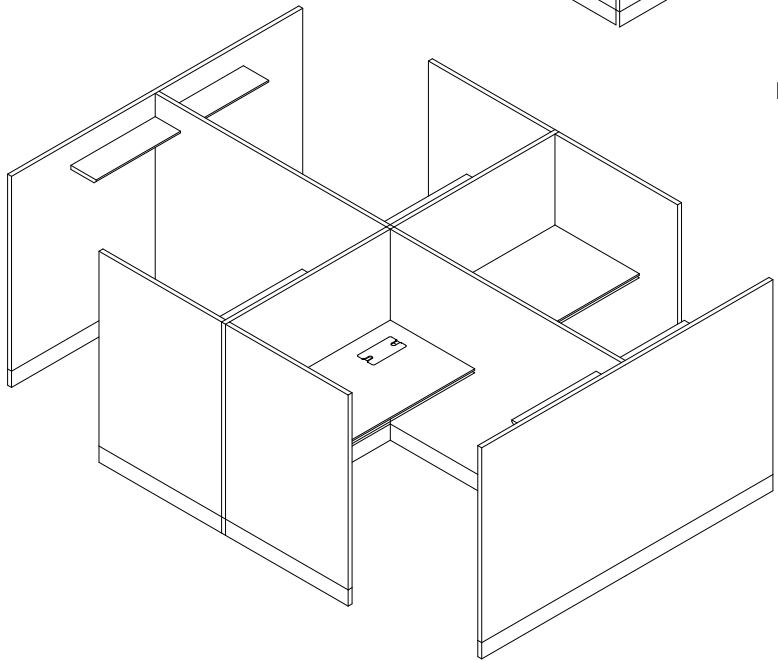

Duo Pod

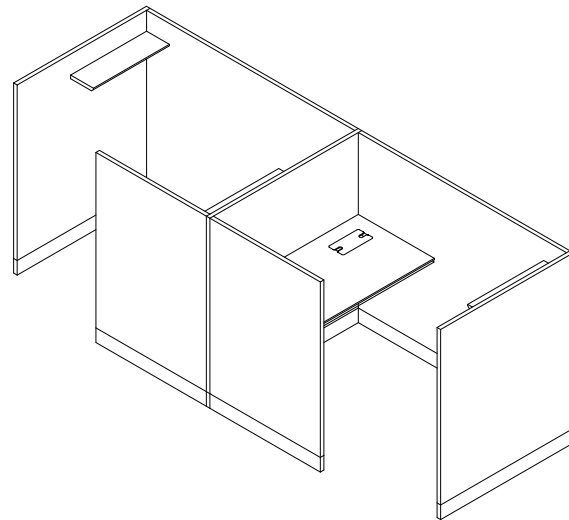



SIMON JAMES

Copyright © 2017 Simon James Design Limited (SJD)
Private and Confidential. No designs, concepts or ideas in this document
may be used without prior written agreement of SJD.