







## LAURENT 03

The Laurent Collection distills the milk globe to its essential relationship between circle and sphere. A series of thin forms compliment the Laurent globes—forms that carve through space, moving between line, surface, and volume. These forms combine in endless patterns, making it possible for an installation of Laurent lamps to inhabit any space with subtlety and quiet strength.

- type:** suspension
- construction:** polished brass, powder coated aluminium or nickel plated steel frame  
handblown opaline glass globe  
powder coated aluminium or brass hardware  
polyester cord
- specifications:** source: LED lamp provided (G9 base)  
power consumption: 2x 4,5W  
lumen output: 638lm  
colour temperature: 2700K included  
\* 3000K available upon request  
colour rendering index: 80 CRI standard  
\* ≥ 90 CRI upon request  
expected lifetime: 25 000h
- control:** refer to our recommended list of dimmer models
- cord length:** 84" / 213 cm (minimum 30" / 76 cm for angled wires)
- weight:** parrallel- brass/nickel plated: 12.1 lb / 5.5 kg  
aluminium: 9.1 lb / 4.1 kg  
angled- brass/nickel plated: 10.3 lb / 4.7 kg  
aluminium: 7.3 lb / 3.3 kg
- certifications:**    
- warranty:** 2 years

parallel wires

parallel wires with offset connection

angled wires

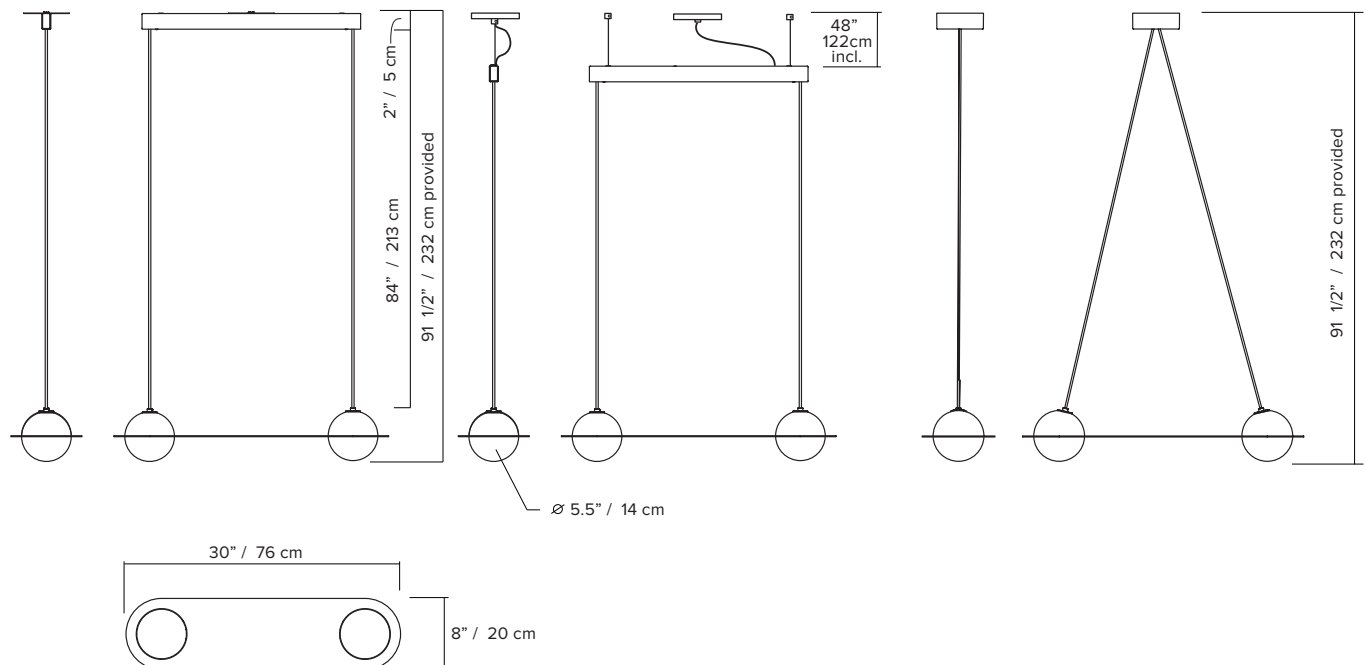

## ORDER GUIDE: SKU

| COLLECTION  | MODEL | MOUNTING POSITION  | FRAME  | CORD SYSTEM  | CANOPY   |
|-------------|-------|--|--|--|--|
| LRT Laurent | 03    | AW angled wires<br>PW parallel wires<br><small>*please specify if offset or standard (ceiling disc) and colour</small> | BK black<br>BR brass<br>BE blue<br>BU burgundy<br>CH nickel plated<br>TU turquoise | BK black<br>BR brass<br>BE blue<br>BU burgundy<br>BG beige | BK black<br>BE blue<br>BU burgundy<br>WH white<br>BG beige<br>TU turquoise |
| LRT         | 03    | AW   | BK   | BK   | BK = LRT03AWBKBBK<br><small>example</small>                                |

### FRAME

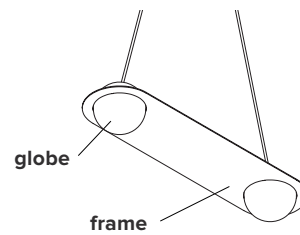
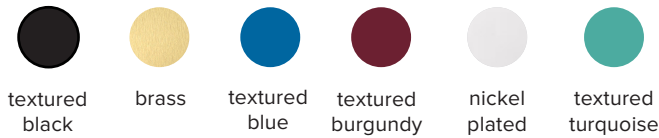

### CORD SYSTEM FINISH globe holders & cords

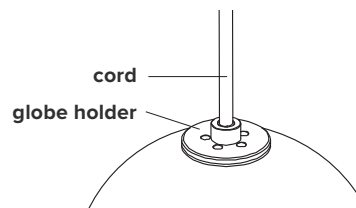
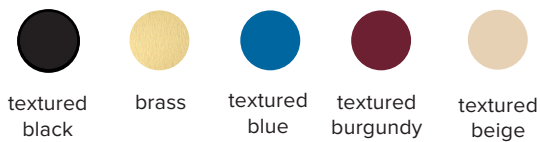

### CANOPY

\*black/white or same colour as cord system except for turquoise

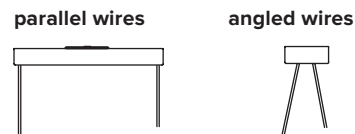
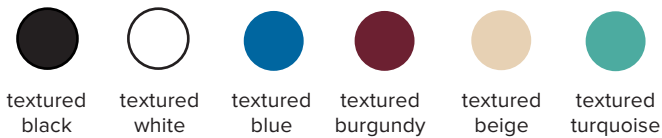

### MOUNTING TYPE SYSTEM

ceiling disc or offset canopy with anchors

\*black/white or same colour as canopy

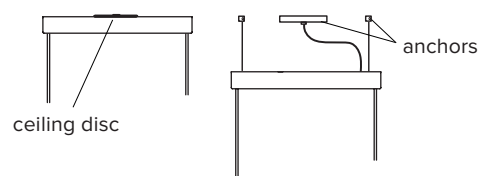
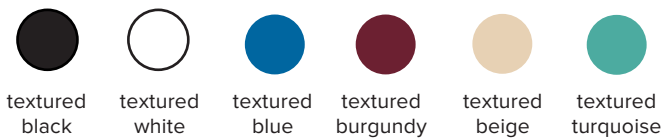

## DIMMER SPECIFICATIONS

### DIMMER LIST COMPATIBILITY FOR G9 LED BULBS – 120V

The dimming technology offering the best results is ELV (electronic low voltage) dimmers with reverse phase or trailing edge control.

| DIMMER BRAND     | MODEL NUMBER   | MIN LEVEL | MAX LEVEL | FLICKERING | OVERALL QUOTE |
|------------------|----------------|-----------|-----------|------------|---------------|
| LUTRON - MAESTRO | MAELV-600      | 0%        | 100%      | 0%-10%     | good          |
| LUTRON - SKYLARK | SELV-300P      | 0%        | 100%      | no         | very good     |
| LUTRON - SKYLARK | SELV-303P      | 0%        | 100%      | no         | very good     |
| LUTRON - SKYLARK | CTELV-303P     | 0%        | 100%      | no         | very good     |
| LUTRON - DIVA    | DVELV-300P     | 0%        | 100%      | no         | very good     |
| LEGRAND - ADORNE | TRUE UNIVERSAL | 30%       | 100%      | no         | good          |

### DIMMER LIST COMPATIBILITY FOR G9 LED BULBS – 230V

| DIMMER BRAND    | MODEL NUMBER | MIN LEVEL | MAX LEVEL | FLICKERING | OVERALL QUOTE |
|-----------------|--------------|-----------|-----------|------------|---------------|
| VARILIGHT       | V-PRO        | 2%        | 100%      | no         | very good     |
| LEGRAND - NILOÉ | 3 996 35     | 15%       | 87%       | no         | good          |
| NIKO            | 310-0280X    | 5%        | 94%       | no         | very good     |
| NIKO            | 310-0190X    | 1%        | 100%      | no         | very good     |

\*Other dimmers can yield good results and we recommend conducting your own test before final installation.

## EU ENERGY LABEL

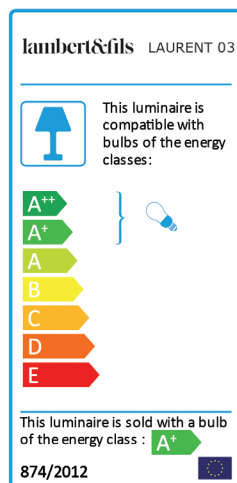

### NOTES:

- must be installed by an electrician
- not protected against liquids (refer to IP20)
- additional charges for modifications or for special orders
- please refer to maintenance sheet on website for cleaning instructions