







BEAUBIEN DOUBLE SHADE

The Beaubien Collection's strong black lines bend in and out of space, moving effortlessly between simplicity and ornamentation. Round and cubic brass connectors complete the lamps' structures and add a rich material contrast to the powder coated rods. The collection's industrial and graphic aesthetic is imbued with a palette of influences, from traditional Chinese screens to the Memphis movement. Each influence strengthens the collection, creating nuance within its timeless character.

- type:** wall
- construction:** powder coated steel and aluminum body
powder coated aluminum shade
brass hardware
milk glass globe
- specifications:** source: LED lamp provided (G9 base)
power consumption: 2x 3,5W
lumen output: 364lm
colour temperature: 2700K included
* 3000K available upon request
colour rendering index: 80 CRI standard
* ≥ 90 CRI upon request
expected lifetime: 25 000h
- control:** refer to our recommended list of dimmer models
- weight:** 3 lb / 1.4 kg
- certifications:**    
- warranty:** 2 years

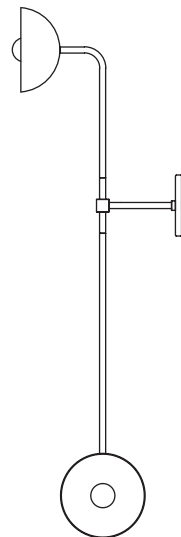
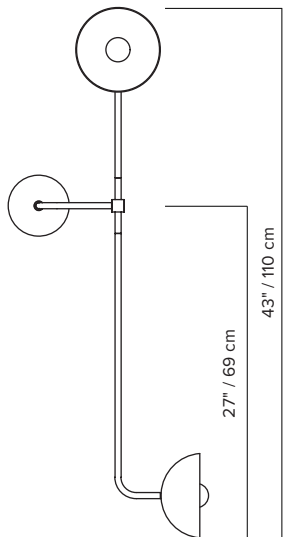
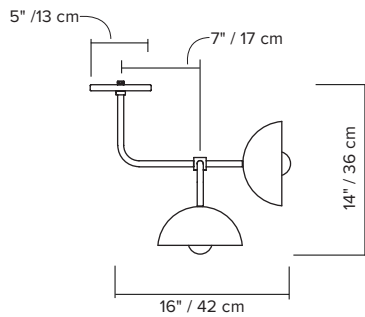

 G50 Ø ±2" / 50 mm

*dimensions are approximate and may vary slightly

ORDER GUIDE: SKU

COLLECTION		MODEL	FINISH		HARDWARE		INSTALLATION	
BEA	beaubien	04	BK	black	BR	brass	A	standard
					GR	graphite	B	reverse
BEA		04	BK		BR		A	= BEA04BKBRA
								example

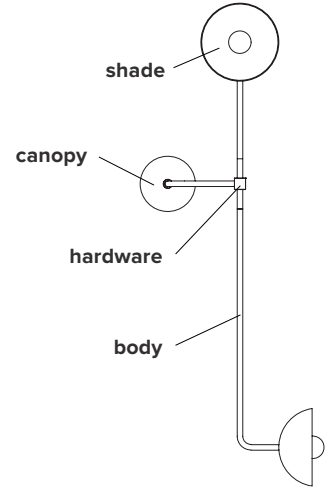

FINISH



textured
black

HARDWARE



graphite



brass

INSTALLATION

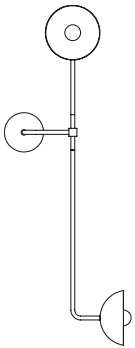

A - standard

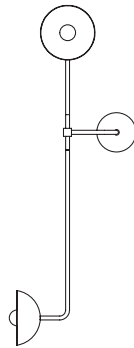

B - reverse

*Luminaire may also be installed horizontally

**Luminaire is not be installed to the ceiling

NOTES:

- must be installed by an electrician
- shades only available in black or white, not brass
- not protected against liquids (refer to IP20)
- additional charges for modifications or for special orders
- please refer to maintenance sheet on website for cleaning instructions

DIMMER SPECIFICATIONS

DIMMER LIST COMPATIBILITY FOR G9 LED BULBS – 120V

The dimming technology offering the best results is ELV (electronic low voltage) dimmers with reverse phase or trailing edge control.

DIMMER BRAND	MODEL NUMBER	MIN LEVEL	MAX LEVEL	FLICKERING	OVERALL QUOTE
LUTRON - MAESTRO	MAELV-600	0%	100%	0%-10%	good
LUTRON - SKYLARK	SELV-300P	0%	100%	no	very good
LUTRON - SKYLARK	SELV-303P	0%	100%	no	very good
LUTRON - SKYLARK	CTELV-303P	0%	100%	no	very good
LUTRON - DIVA	DVELV-300P	0%	100%	no	very good
LEGRAND - ADORNE	TRUE UNIVERSAL	30%	100%	no	good

DIMMER LIST COMPATIBILITY FOR G9 LED BULBS – 230V

DIMMER BRAND	MODEL NUMBER	MIN LEVEL	MAX LEVEL	FLICKERING	OVERALL QUOTE
VARILIGHT	V-PRO	2%	100%	no	very good
LEGRAND - NILOÉ	3 996 35	15%	87%	no	good
NIKO	310-0280X	5%	94%	no	very good
NIKO	310-0190X	1%	100%	no	very good

*Other dimmers can yield good results and we recommend conducting your own test before final installation.

EU ENERGY LABEL

lambert&fils BEAUBIEN 04



This luminaire is compatible with bulbs of the energy classes:

A++

A+

A

B

C

D

E

}



This luminaire is sold with a bulb of the energy class : A+

874/2012 