



## DA OLTRE 70 ANNI DISEGNAMO LA LUCE

La forza evocativa dell'illuminazione è essenziale quanto le sue potenzialità funzionali, capaci di tradurre in manufatti idee e intuizioni.

Con oltre 70 anni di esperienza nel campo dell'illuminazione Oluce si è costruita un solido bagaglio di competenze tecniche ed illuminotecniche, oltre ad uno stile inconfondibile. Dal 1945 Oluce immagina, sviluppa e produce lampade decorative. Oggetti di design, identificati da una bellezza intellettuale ed un'estetica incisiva e decorativa, che dialogano con l'ambiente e trasformano gli spazi di vita.

L'esperienza dell'azienda rivela un'eccellenza produttiva che ha dato vita nel tempo ad icone apprezzate in tutto il mondo e a progetti di altissima qualità, nati dalla collaborazione con i maestri storici del design, come Joe Colombo e Vico Magistretti, così come dalle recenti collaborazioni con designer di fama internazionale.

Inoltre, l'esperienza tecnica dell'azienda e il suo legame con il mondo del progetto hanno sviluppato il Bespoke Tailoring, un servizio di personalizzazione prodotto rivolto ad architetti e progettisti, che consente di realizzare prodotti su misura oppure varianti modulabili di prodotti già a collezione.

## LA NUOVA MINI COUPÉ

Coupé nacque nel 1967 da un'intuizione di Joe Colombo che la concepì inizialmente come variante della lampada Calotta, già nella collezione dell'azienda. Partendo da questi segni grafici ed essenziali - la base, il fusto e la calotta orientabile a fare da paralume - il designer diede vita ad una delle famiglie più conosciute di Oluce.

Dopo averla declinata nel tempo in modelli e finiture differenti, Oluce amplia la famiglia Coupé introducendo Mini Coupé, la variante in scala ridotta della lampada da tavolo e proposta in una nuova affascinante e contemporanea gamma colori.

Nei suoi 34 cm di altezza e nelle sue nuove cromie, Mini Coupé raccoglie con divertente armonia tutta la forza che ha accumulato i prodotti disegnati da Joe Colombo negli anni Sessanta, quando nel progetto si voleva rispondere a una funzione ma al contempo si cercava il gesto estetico, quando la sperimentazione per i nuovi materiali, l'uso del colore, il movimento e la volontà di andare al di là degli schemi consueti erano la luce guida delle sue creazioni.

## DESIGNING LIGHT FOR OVER 70 YEARS

The evocative power of lighting is as essential as its functional potential, able to translate ideas and intuition into a manufactured article.

With over 70 years of experience in the field of illumination, Oluce has built a solid background of technical and lighting engineering skills, in addition to an unmistakable style. Oluce has been creating, developing, and producing decorative lamps since 1945. These objects of design, marked by a distinctive intellectual beauty and a bold, decorative aesthetic, dialogue with their setting and transform the living space.

The company's experience demonstrates a manufacturing excellence which over the years has resulted in iconic pieces admired the world over and top-quality designs, arising not only from collaborations with legendary masters of design such as Joe Colombo and Vico Magistretti, but also more recent collaborations with internationally renowned designers. In addition, the company's technical expertise and its links with the design world have led to the development of Bespoke Tailoring, a product customisation service aimed at architects and designers, which allows the creation of custom products or modular variants of existing catalogue products.

## THE NEW MINI COUPÉ

Coupé originated in 1967 from the creative intuition of Joe Colombo, who initially designed it as a variation on a lamp already in the company's collection, the Calotta lamp. Starting from these bold, simple features - the base, the stem and the adjustable cover serving as a shade - the designer created one of Oluce's best-known families. Having offered the Coupé in a variety of different models and finishes over the years, Oluce is expanding the family with the introduction of Mini Coupé, a smaller scale version of the table lamp, available in a stunning new contemporary range of colours. At 34 cm in height and in brand new colours, the Mini Coupé wittily maintains all the vigour common to Joe Colombo's designs of the 60s, a time when design aimed to fulfil a function while also making an aesthetic statement, when experimentation with new materials, use of colour, movement, and the desire to break new ground were the guiding lights of his creations.



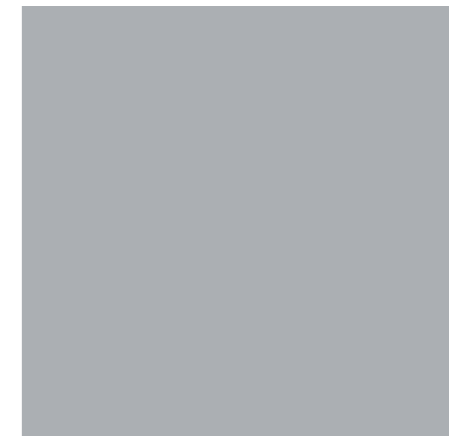
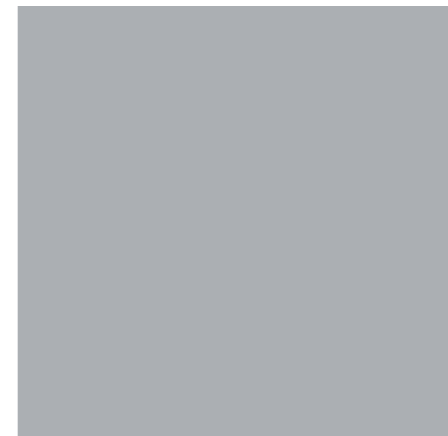
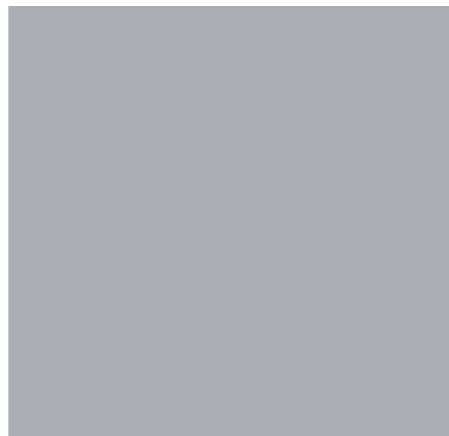
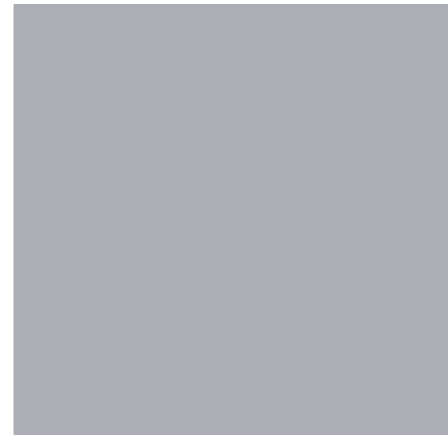
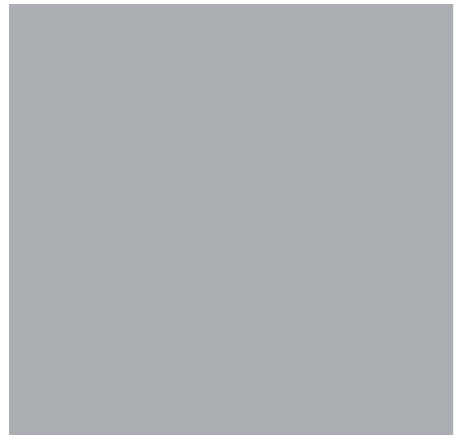
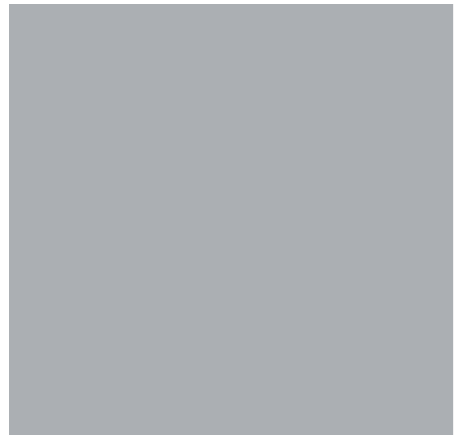





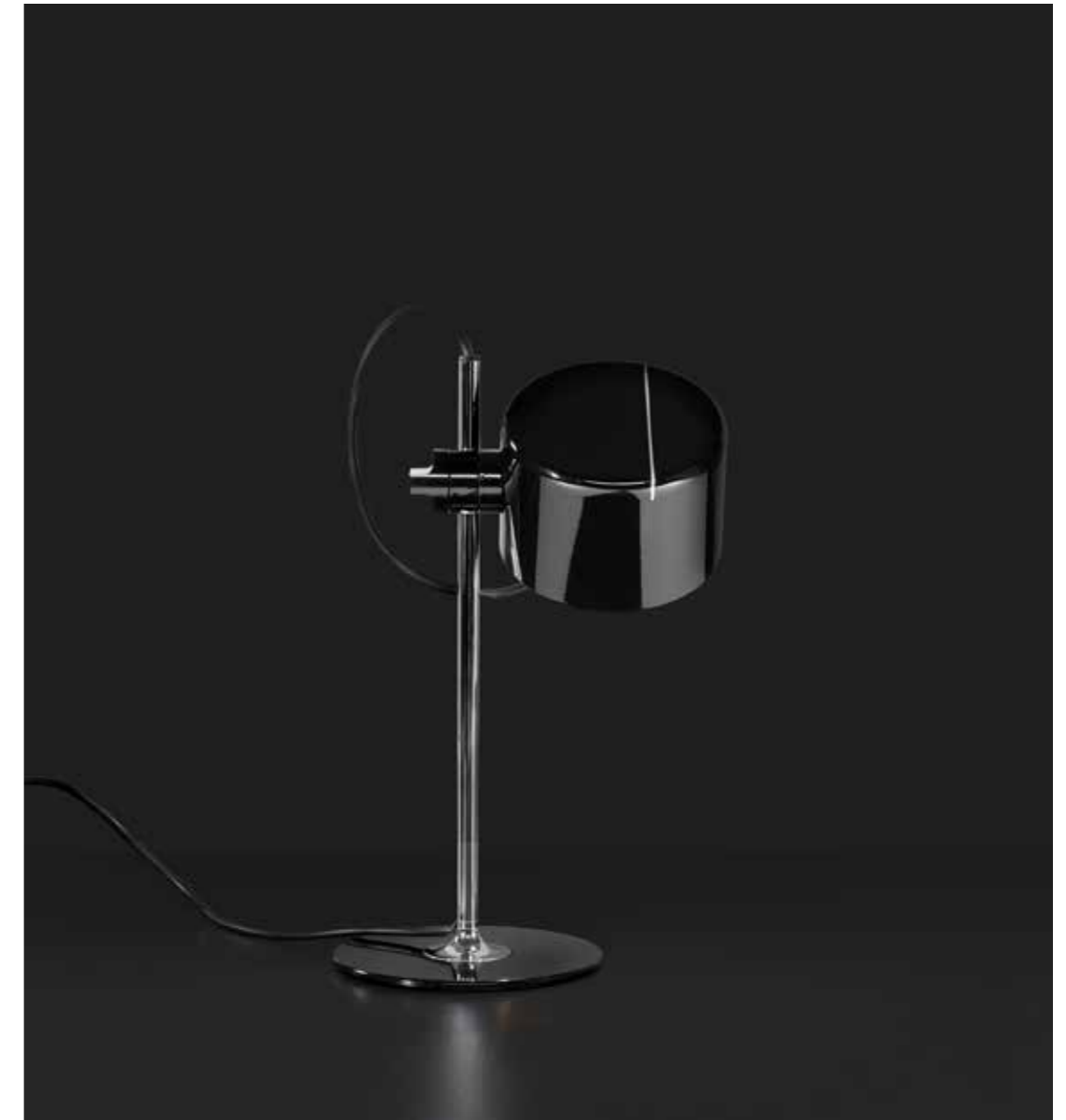

**MINI COUPÈ**

Joe Colombo  
1967

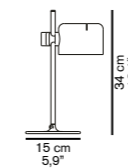

2201



CODICE/CODE	SORGENTI/BULBS	MATERIALI/MATERIALS	COLORE/COLORS	MARCHI/MARKS
2201	 1 x max 3 W G9 (LED) 3000° K - 300 lm - CRI>85 	metallo/alluminio metal/aluminium	nero lucido/lacquered black bronzo anodic/anodic bronze rosso scarlet/scarlet-red giallo mustard/ mustard yellow	





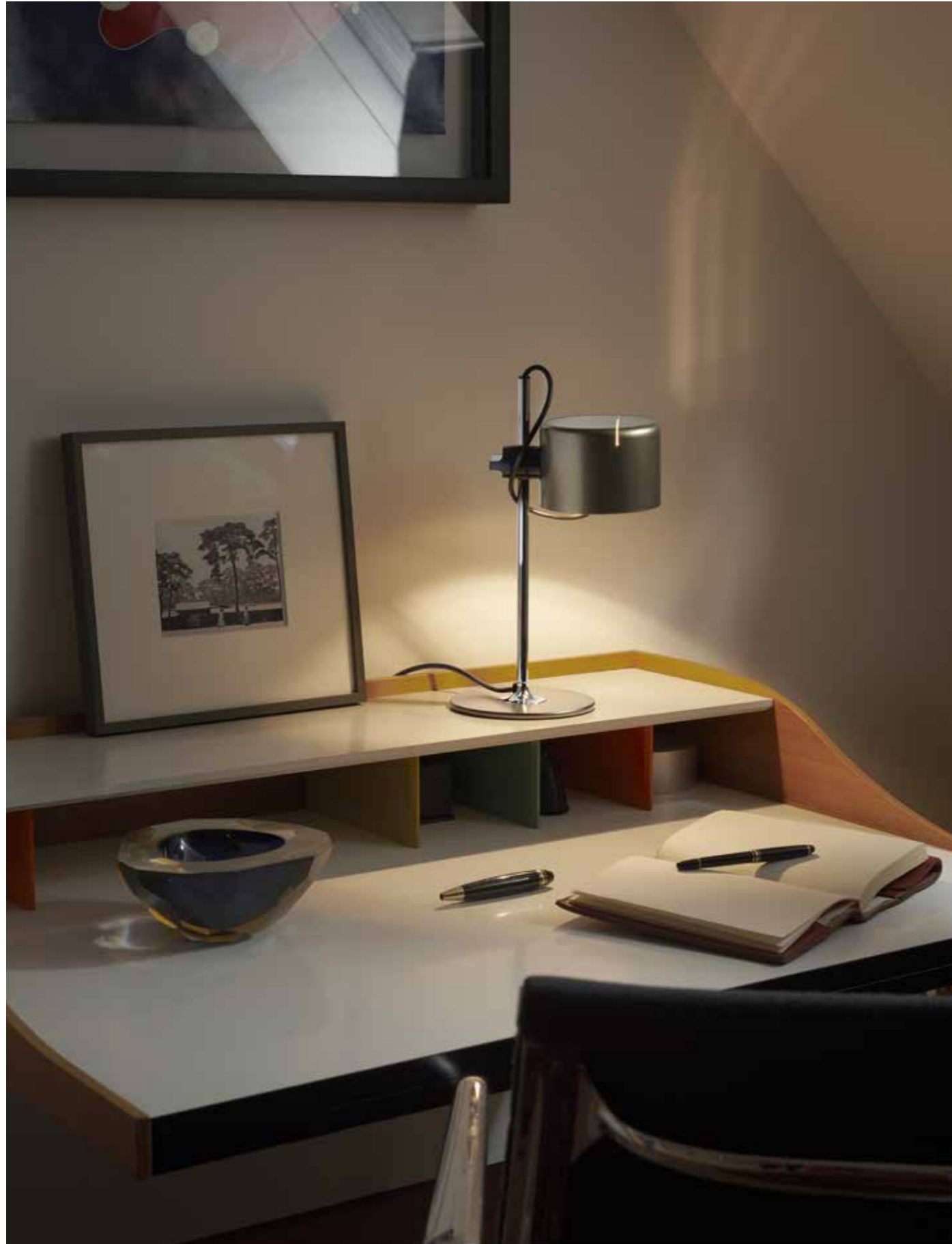

**MINI COUPÈ 2201**

Joe Colombo  
1967

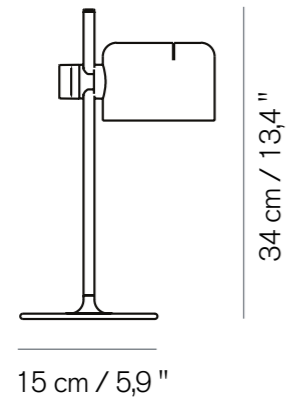

**COUPÈ 2202**

Joe Colombo  
1967

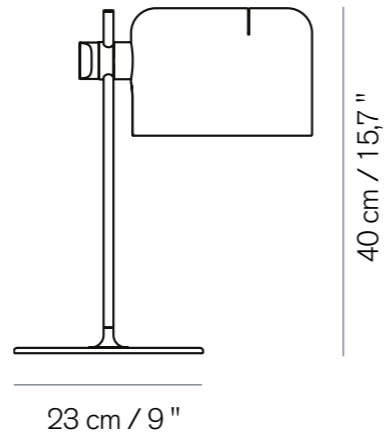

**COUPÈ 1158**

Joe Colombo  
1967

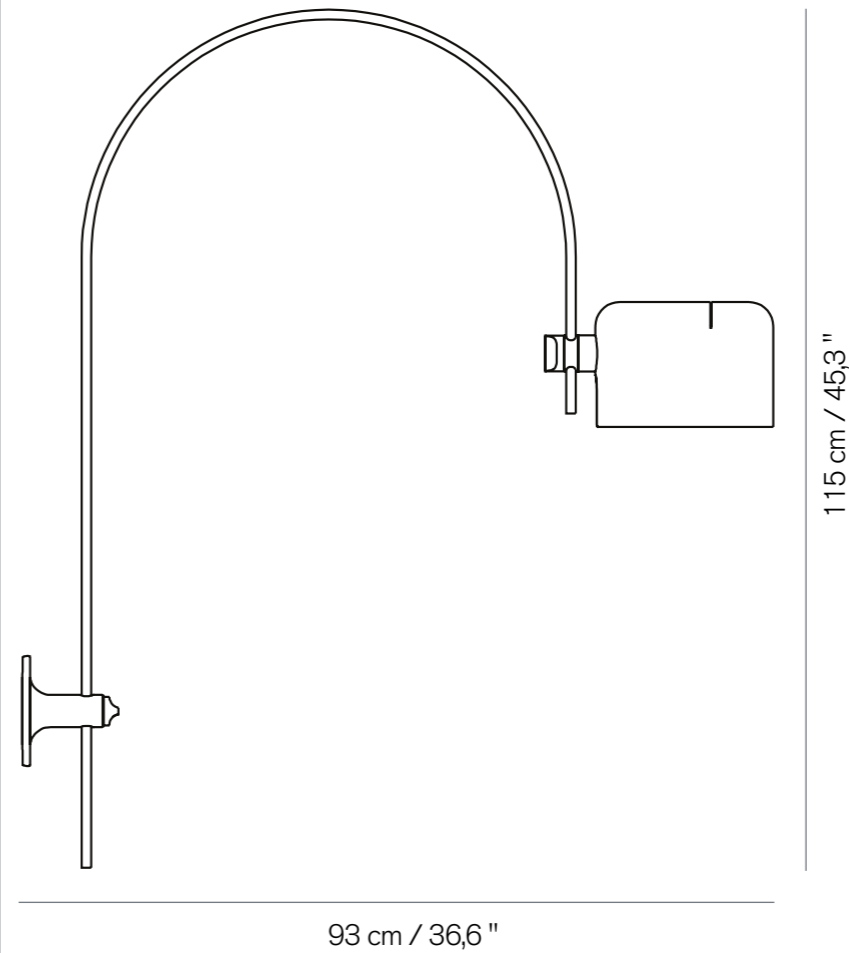

**COUPÈ 3321**

Joe Colombo  
1967

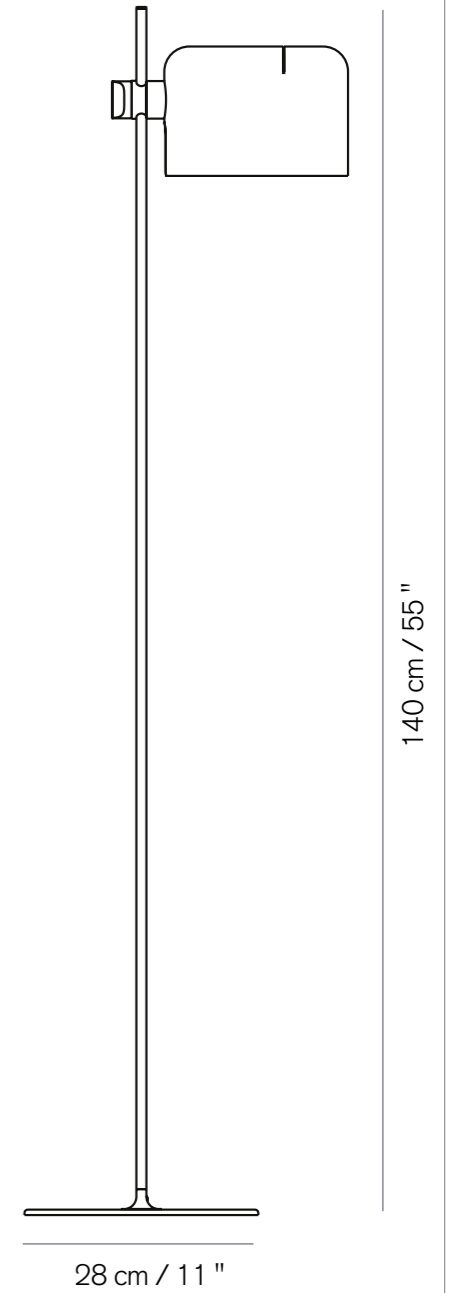



Graphic Design  
**GB studio**

Fotografie / Photos  
**Miro Zagnoli**

Coordinamento / Coordination  
**Franco Lettera**  
**R + W**

**O luce s.r.l.**

Uffici commerciali e stabilimenti:  
Via Brescia, 2 - 20097  
San Donato Milanese - Milano  
T. 02) 98 49 14 35 - F. 02) 98 49 07 79  
[www.oluca.com](http://www.oluca.com) [info@oluca.com](mailto:info@oluca.com)