

Operating and Maintaining the P10 Console



Operating and Maintaining the P10 Console

PRECOR®

Edition Information

OPERATING AND MAINTAINING THE P10 CONSOLE

P/N 302291-112 rev C

Copyright © October 2014 Precor Incorporated. All rights reserved. Specifications subject to change without notice.

Trademark Note

Precor, AMT, EFX, and Preva are registered trademarks of Precor Incorporated. Other names in this document may be the trademarks or registered trademarks of their respective owners.

Intellectual Property Notice

All rights, title, and interests in and to the software of the Preva Business Suite, the accompanying printed materials, any copies of such software, and all data collected via the Preva Business Suite, are exclusively owned by Precor or its suppliers, as the case may be.

Precor is widely recognized for its innovative, award-winning designs of exercise equipment. Precor aggressively seeks U.S. and foreign patents for both the mechanical construction and the visual aspects of its product design. Any party contemplating the use of Precor product designs is hereby forewarned that Precor considers the unauthorized appropriation of its proprietary rights to be a very serious matter. Precor will vigorously pursue all unauthorized appropriation of its proprietary rights.

Precor Incorporated
20031 142nd Ave NE, P.O. Box 7202
Woodinville, WA 98072-4002
1-800-347-4404

<http://www.precor.com>

Important Safety Instructions

Important: *Save these instructions for future reference.*

Read all instructions in the documentation provided with your exercise equipment, including all assembly guides, user guides, and owner's manuals, before installation of this device.

Note: This product is intended for commercial use.

The display apparatus (hereinafter referred to as the *console*) is intended to be shipped with new Precor exercise equipment (hereinafter referred to as the *base unit*). It is not packaged for individual sale.

WARNING To prevent injury, the console must be attached securely to the base unit following all assembly and installation instructions shipped with the base unit. The console is intended to be connected to AC mains power through the furnished power supply ONLY. It should be powered on only when installed as described in the assembly and installation instructions shipped with the base unit. The console is intended for use only with Precor fitness equipment, not as a standalone device.

Safety Precautions

Always follow basic safety precautions when using this equipment to reduce the chance of injury, fire, or damage. Other sections in this manual provide more details of safety features. Be sure to read these sections and observe all safety notices. These precautions include the following:

- Read all instructions in this guide before installing and using the equipment and follow any labels on the equipment.
- Make sure all users see a physician for a complete physical examination before they begin any fitness program, particularly if they have high blood pressure, high cholesterol or heart disease; have a family history of any of the preceding conditions; are over the age of 45; smoke; are obese; have not exercised regularly in the past year; or are taking any medication.

French equivalent of the above notice, for Canadian markets: *Il est conseillé aux utilisateurs de subir un examen médical complet avant d'entreprendre tout programme d'exercice, en particulier s'ils souffrent d'hypertension artérielle, ou de cardiopathie ou ont un taux de cholestérol élevé, s'ils ont des antécédents familiaux des précédentes maladies, s'ils ont plus de 45 ans, s'ils fument, s'ils sont obèses, s'ils n'ont pas fait d'exercices réguliers au cours de l'année précédente ou s'ils prennent des médicaments. Si vous avez des étourdissements ou des faiblesses, arrêtez les exercices immédiatement.*

- Do not allow children, or people unfamiliar with the operation of this equipment, on or near it. Do not leave children unsupervised around the equipment.
- Make sure all users wear proper exercise clothing and shoes for their workouts and avoid loose or dangling clothing. Users should not wear shoes with heels or leather soles, and they should check the soles of their shoes to remove any dirt and embedded stones. They should also tie long hair back.

- Never leave the equipment unattended when it is plugged in. Unplug the equipment from its power source when it is not in use, before cleaning it, and before providing authorized service.

Note: The optional power adapter is considered a power source for self-powered equipment.

- Use the power adapter provided with the equipment. Plug the power adapter into an appropriate, grounded power outlet as marked on the equipment.
- Care should be taken when mounting or dismounting the equipment.
- For Treadmills: Do not use typing or web surfing features while walking at speeds that exceed a **slow and relaxed leisurely pace**. Always stabilize yourself by holding a stationary handle bar while using typing or web surfing features.
- For AMT and EFX: Always stabilize yourself by holding a stationary handle bar while using typing or web surfing features.
- Read, understand, and test the emergency stop procedures before use.
- Keep the power cord or optional power adapter and plug away from heated surfaces.
- Route power cables so that they are not walked on, pinched, or damaged by items placed upon or against them, including the equipment itself.
- Ensure the equipment has adequate ventilation. Do not place anything on top of or over the equipment. Do not use on a cushioned surface that could block the ventilation opening.
- Assemble and operate the equipment on a solid, level surface.

- **SPACING**—The below minimum spacing recommendations are based on a combination of the ASTM (U.S.) voluntary standards and EN (European) regulations as of October 1, 2012, for access, passage around, and emergency dismount:
 - **Treadmills**—a minimum of 0.5 m (19.7 in.) on each side of the treadmill and 2 m (78 in.) behind the machine.
 - **Cardio equipment other than treadmills**—a minimum of 0.5 m (19.7 in.) on at least one side, and 0.5 m (19.7 in.) behind or in front the machine.

Careful consideration should be given to the requirements of the Americans with Disabilities Act (ADA), US Code 28 CFR (see Section 305). ASTM standards are voluntary and may not reflect current industry standards. The actual area for access, passage around, and emergency dismount is the responsibility of the facility. The facility should consider the total space requirements for training on each unit, voluntary and industry standards, and any local, state, and federal regulations. Standards and regulations are subject to change at any time.

Important: *These spacing recommendations should be used when positioning equipment away from sources of heat, such as radiators, heat registers, and stoves. Avoid temperature extremes.*

- Keep equipment away from water and moisture. Avoid dropping anything on or spilling anything inside the equipment to prevent electric shock or damage to the electronics.
- When using the treadmill, always attach the safety clip to your clothing before beginning your workout. Failure to use the safety clip may pose a greater risk of injury in the event of a fall.
- Keep in mind that heart rate monitors are not medical devices. Various factors, including the user's movement, may affect the accuracy of the heart rate readings. The heart rate monitors are intended only as exercise aids in determining heart rate trends in general.
- Do not operate electrically powered equipment in damp or wet locations.
- Never operate this equipment if it has a damaged cord or plug, if it is not working properly, or if it has been dropped, damaged, or exposed to water. Call for service immediately if any of these conditions exist.

- Maintain the equipment to keep it in good working condition, as described in the *Maintenance* section of the owner's manual. Inspect the equipment for incorrect, worn, or loose components, and then correct, replace or tighten prior to use.
- If you plan to move the equipment, obtain help and use proper lifting techniques.
- Equipment Weight Restrictions: Do not use the treadmill if you weigh more than 400 pounds (180 kg). If you weigh more than 350 pounds (160 kg), do not run on the treadmill. For all other fitness equipment, the weight limit is 350 pounds (160 kg).
- Use the equipment only for its intended purpose as described in this manual. Do not use accessory attachments that are not recommended by Precor. Such attachments may cause injuries.
- Do not operate the equipment where aerosol (spray) products are being used or where oxygen is being administered.
- Do not use outdoors.
- Do not attempt to service the equipment yourself, except to follow the maintenance instructions in the owner's manual.
- Never drop or insert objects into any opening. Keep hands away from moving parts.
- Do not set anything on the stationary handrails, handlebars, control console, or covers. Place liquids, magazines, and books in the appropriate receptacles.
- Do not lean on or pull on the console at any time.



CAUTION: DO NOT remove the cover, or you may risk injury due to electric shock. Read the assembly and maintenance guide before operating. There are no user-serviceable parts inside. Contact Customer Support if the equipment needs servicing. For use with single phase AC power only.

Hazardous Materials and Proper Disposal

The batteries within self-powered equipment contain materials that are considered hazardous to the environment. Federal law requires proper disposal of these batteries.

If you plan to dispose of your equipment, contact Precor Commercial Products Customer Support for information regarding battery removal. Refer to *Obtaining Service*.

Product Recycling and Disposal

This equipment must be recycled or discarded according to applicable local and national regulations.

Product labels, in accordance with European Directive 2002/96/EC concerning waste electrical and electronic equipment (WEEE), determine the framework for the return and recycling of used equipment as applicable throughout the European Union. The WEEE label indicates that the product is not to be thrown away, but rather reclaimed upon end of life per this Directive.

In accordance with the European WEEE Directive, electrical and electronic equipment (EEE) is to be collected separately and to be reused, recycled, or recovered at end of life. Users of EEE with the WEEE label per Annex IV of the WEEE Directive must not dispose of end of life EEE as unsorted municipal waste, but use the collection framework available to customers for the return, recycling, and recovery of WEEE. Customer participation is important to minimize any potential effects of EEE on the environment and human health due to the potential presence of hazardous substances in EEE. For proper collection and treatment, refer to *Obtaining Service*.

Regulatory Notices for Cardiovascular Exercise Equipment

The regulatory information in this section applies to the exercise equipment and its control console.

Safety Approvals for Cardiovascular Equipment

Precor equipment has been tested and found to comply with the following applicable safety standards.

Cardiovascular Type Equipment:

- CAN/CSA, IEC, EN 60335-1 (Household and similar electrical appliances - Safety)
- EN 957 (Stationary training equipment, class S/B compliant equipment)

Radio Frequency Interference (RFI)

This Precor exercise equipment conforms to the following national standards defining acceptable limits for radio frequency interference (RFI).

Federal Communications Commission, Part 15

This equipment has been tested and found to comply with the limits for a Class A digital device, pursuant to Part 15 of the FCC Rules. These limits are designed to provide reasonable protection against harmful interference in a commercial installation. The equipment generates, uses, and can radiate radio frequency energy and, if not installed and used in accordance with the owner's manual instructions, can cause harmful interference to radio communications.

Operation is subject to the following two conditions: (1) this device may not cause harmful interference, and (2) this device must accept any interference received, including interference that may cause undesired operation.

WARNING Per FCC rules, changes or modifications not expressly approved by the manufacturer could void the user's authority to operate the equipment.

Industry Canada

This device complies with RSS-210:2007 of the Spectrum Management & Telecommunications Radio Standards Specification. Operation is subject to the following two conditions: (1) this device may not cause harmful interference, and (2) this device must accept any interference received, including interference that may cause undesired operation.

This Class A digital apparatus complies with Canadian ICES-003.

Cet appareil numérique de la classe A est conforme à la norme NMB-003 du Canada.

ATTENTION: Haute Tension
Débranchez avant de réparer

European Applications

CE compliance is claimed to the following directives:

- 2004/108/EC EMC Directive
- 2006/95/EC LVD Directive
- 2002/95/EC RoHS Directive

Directive compliance has been verified to the following standards:

- EN 55022
- EN 55024
- EN 60335-1
- EN 60065 (P80 and PVS)

Electrical Recommendations: 120 V and 240 V Treadmills

Note: This is a recommendation only. NEC (National Electric Code) guidelines or local region electric codes must be followed.

You should have received a power cable that meets your local electrical code requirements along with the equipment. Precor treadmills must be connected to a 20 amp individual branch circuit that can be shared only with one PVS. If you need additional help with the power connections contact your Precor authorized dealer.

Important: An individual branch circuit provides a hot conductor and neutral conductor to a receptacle. The conductors must not be looped, "daisy-chained", or connected to any other conductors. The circuit must be grounded according to NEC guidelines or local region electric codes.

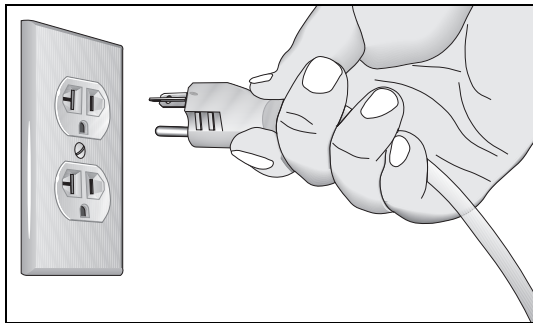

Figure 1: North American 120-volt, 20-amp power receptacle

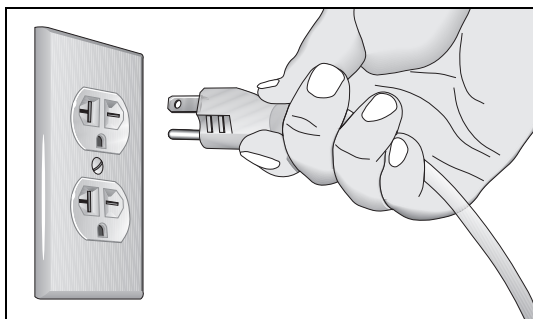

Figure 2: North American 240-volt, 20-amp power receptacle

Electrical Recommendations: All Equipment Excluding Treadmills

Note: This is a recommendation only. NEC (National Electric Code) guidelines or local region electric codes must be followed.

For equipment fitted with a P80 console or Personal Viewing System (PVS) screen a separate power connection is required. For a 20 amp branch circuit up to 10 screens can be connected. If the branch circuit has any other devices plugged into the circuit, then the number of screens must be reduced by the wattage of the other devices.

Note: The typical splitter power cords that have IEC-320 C13 and C14 plugs have a recommended maximum capacity of five screens.

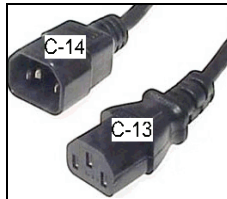

Figure 3: IEC-320 C13 and C14 plugs

Obtaining Service

Do not attempt to service the equipment except for maintenance tasks. If any items are missing, contact your dealer. For more information regarding customer support numbers or a list of Precor authorized service centers, visit the Precor web site at <http://www.precor.com>.

Table of Contents

Important Safety Instructions	3
Safety Precautions.....	4
Hazardous Materials and Proper Disposal.....	8
Product Recycling and Disposal	8
Regulatory Notices for Cardiovascular Exercise Equipment.....	9
Electrical Recommendations: 120 V and 240 V Treadmills	11
Electrical Recommendations: All Equipment Excluding Treadmills.....	12
Obtaining Service.....	12
Getting Started.....	15
Activating the Console for Self-Powered Equipment	15
Identifying Parts of the Console.....	17
Setting Up the Console	19
System Settings.....	19
Club Parameters.....	21
Viewing the Informational Displays	25
User ID Entry with CSAFE Equipment.....	30
Introducing Users to the P10 Console.....	31
Using the Touch Heart Rate Feature	31
Using a Chest Strap Transmitter.....	33
Using the Treadmill Safety Clip	34
Treadmill Auto Stop™ (Automatic Stop) Function.....	36

Starting a Workout	37
Starting a Preset Programmed Workout	38
Pausing and Resuming an Exercise Session.....	38
Ending a Session.....	39
Workouts.....	41
Maintenance.....	49
Cleaning the Console and Display.....	50
Checking and Resetting the Active Status Light (Treadmill Only).....	51
Changing the Belt (AMT Only)	54

Getting Started

The P10 console offers administrators the ability to set default values that meet their specific needs. These values include items like language, units of measure, and setting a maximum allowed workout time for each piece of equipment.

Activating the Console for Self-Powered Equipment

Precor equipment is either self-powered or externally powered using an optional power adapter. Self-powered equipment requires the user exercise to initialize the console. This section provides more detail about powering equipment.

Activating the Console for Self-Powered Equipment

On self-powered equipment, when a user starts exercising, the console initializes and displays the Welcome banner. A minimum rate of motion must be maintained for the Welcome banner to appear. The words PEDAL FASTER (or the equivalent message depending on the equipment type) appear in the display when the rate of motion drops below the minimum requirements.

The equipment saves its battery charge by moving into a shutdown mode. If the user does not maintain the minimum rate of motion, a 30-second shutdown process begins.

In this mode, the console displays a countdown indicator and ignores all keypresses. If no movement is detected or the rate of motion remains below the minimum, the indicator changes as the countdown continues.

Note: The user can resume exercising before the countdown period elapses and the workout will continue from the point at which it was paused.

Optional Use of the Power Adapter

An optional AC power adapter provides sustained power to the equipment. This adapter allows you to change settings without having to pedal the equipment. To purchase the power adapter, contact your dealer.

If you purchase the optional power adapter, you must also purchase the internal cable kit. The kit supplies the cable, bracket, and fasteners that connect the power adapter to the lower electronics board.

CAUTION: The internal cable kit must be installed by authorized service personnel. Do not attempt installation on your own as you could void the Precor Limited Warranty. For more information, refer to *Obtaining Service*.

Important: *If this equipment includes a P80 console, the optional power adapter and the internal cable kit must still be installed to provide continuous power to the base unit and support its internal battery.*

Once the internal cable kit is installed, you can plug the optional power adapter into the equipment. Plug the opposite end into the appropriate power source for your equipment (120 V or 240 V). Review the safety instructions found at the beginning of this manual before using the power adapter.

CAUTION: When the optional power adapter is in use, make sure that the power supply cord does not create a safety hazard. Keep it out of the way of traffic and moving parts. If the power supply cord or power conversion module is damaged, it must be replaced.

The control console functions differently when the power adapter is connected. Because the power adapter provides a constant source of power, a user can pause for brief periods without initiating shutdown procedures. When the pause time limit expires and the user has not resumed exercising, the console returns to the Welcome screen. The default pause time is 30 seconds for all fitness equipment. Refer to the manual for your control console for instructions on setting or changing the pause time limit.

Identifying Parts of the Console

The following figure provides information about the console keys. The number and actions of the console keys may differ slightly depending on the type of equipment.

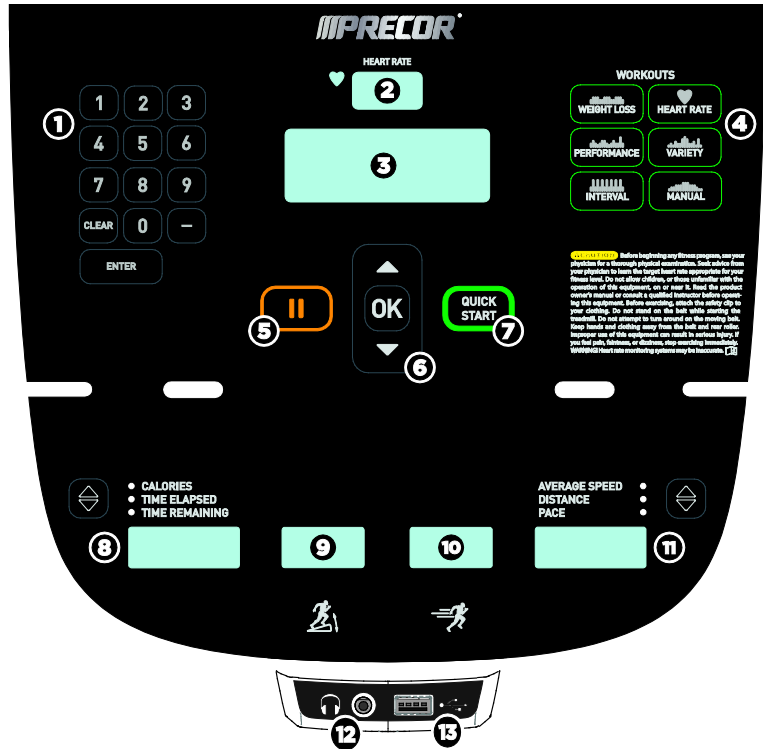

Figure 4: P10 console keys

Table 1. Parts of the console

Number	Name	Details
1	Number pad	Enter numerical information such as age, weight, and passwords. You can also enter and change channels using the number pad. <ul style="list-style-type: none"> Press Clear to delete the numbers you entered. Press Enter to confirm your selection.
2	Heart Rate	Displays your current heart rate.
3	Lower Display	Displays graphical information about your workout progress.

Number	Name	Details
4	Workouts	Examples of workouts: <ul style="list-style-type: none"> • Manual • Heart Rate • Interval • Weight Loss • Variety • Performance
5	Pause	Use to pause or end a workout session.
6	OK and Up/Down arrows	Use to navigate options and settings.
7	Quick Start	Press Quick Start to begin exercising.
8	<ul style="list-style-type: none"> • Calories • Time Elapsed • Time Remaining • Watts (bike) • Time (bike) 	Use the ▲ or ▼ arrows to change what information is displayed.
9	Incline or Crossramp	Available on treadmill and EFX (dual).
10	Speed or Resistance	Available on AMT, bike, treadmill, EFX (single), and EFX (dual).
11	<ul style="list-style-type: none"> • Average Speed (treadmill) • Speed (bike) • Pace (treadmill) • Distance (all equipment) • RPM (bike) • Cals/Min (AMT) • Strides/Min (AMT, EFX) • Total Strides (EFX) 	Use the ▲ or ▼ arrows to change what information is displayed.
12	Audio Jack (For consoles with media option)	Plug in headphones to hear audio.
13	Mobile Device Charger	USB port to charge devices while using equipment.

Setting Up the Console

Use the System mode to configure settings in ways that benefit your users and your facility. The System menu is visible only to administrators and registered service technicians. Changes made to these settings are saved to the fitness equipment.

The System Settings categories are:

- Club Parameters
- Informational Display

System Settings

System Setting features remain hidden from club patrons and can only be accessed using special keypresses. To view the System Settings, the equipment must be in the Welcome state. The equipment is in the Welcome state when it is on, but not actually in use. This means that there is no exercise session, data entry, or diagnostic operation in progress.

When the equipment is in the Welcome state:

- **SELECT A WORKOUT OR PRESS QUICKSTART TO BEGIN** scrolls in the text display.
- On the treadmill, the belt is not moving and the lift motor is off.

Note: On self-powered equipment, the console initializes when you begin working out. You must maintain a minimum rate of motion for the Welcome banner to appear.

The changes made in System Setting modes become the default settings when the display resets to the Welcome banner.

CAUTION: If you change the Unit of Measure display on the treadmill, check the speed setting to verify that it is correct.

To view the Club Settings:

1. At the Welcome banner, press **Pause**.



2. Press the following number keys in sequence to enter the password:

5 6 5 1 5 6 5

3. Press **OK**.

The Set Club Parameters banner appears.

Table 2. Navigational keys for the system setting modes

Key	Function
▲ or ▼	Navigates the settings menu
OK	Selects a menu setting and confirms the changes made to the value setting
CLEAR	Returns to the previous menu level without saving changes
PAUSE	Exits the System Settings mode and returns to the Welcome banner

Club Parameters

Use the following information to customize the equipment for your setting.

Note: When you make changes to the club parameters, the new settings replace the factory default settings.

Safety Code (Treadmill only)

Value: Enabled or Disabled

(Default: Disabled)

When the equipment is shipped from the factory, the safety code protection feature is disabled. If you enable the safety code, your users will need to enter a four digit number to begin their exercise session and start the running belt. The code is **1 2 3 4**.

Select Language (All Equipment)

Value: English, Deutsch, Espanol, Francais, Netherlands, Portugues, Rucckijj, and Italiano

(Default: English)

Select your preferred language for the console display.

Note: Programming prompts are not affected by language selection. The prompts in this section continue to appear in English.

Select Units (All Equipment)

Value: U.S. or Metric

(Default: U.S.)

The equipment can display measurements in either Metric or U.S. Standard.

Important: *If you change the Unit of Measure on a treadmill, be sure to check the speed setting to verify that it is correct.*

Set Max Workout Time (All Equipment)

Value Range: 1 to 240 minutes

(Default: 60 minutes)

You can set a maximum workout time per session. Choose a time limit between 1 and 240 minutes, or select **No Limit** if you do not want to set a time limit. For example, if you set the time limit to 20 minutes, users can only enter a workout time between 1 and 20 minutes.

Set Max Pause Time (All Equipment)

Value Range: 1 to 120 seconds

(Default: 120 seconds)

This setting limits how long equipment remains in a paused banner during a workout before it resets.

Note: The optional power adapter must be connected on self-powered equipment to establish a definitive pause time limit. If the optional power adapter is not attached and the rate of motion drops below the minimum requirements, the equipment begins its shutdown, effectively eliminating pause mode.

Set Cool Down Time (All Equipment)

Value Range: 0 to 5 minutes

(Default: 5 minutes)

Select the maximum amount of time the equipment remains in the cool down mode. The cool down time is the period of time following the completion of a program when the user exercises at a reduced work rate.

Set Speed Limit (Treadmill only)

Value Range: Full speed range of equipment

(Default: Maximum speed)

This setting limits how fast the running belt moves and, consequently, the number of speed settings that are available to the user. Use it to set the maximum speed that a user can enter when using the equipment.

The speed is displayed in miles per hour (mph) or kilometers per hour (kph) depending upon the units of measure (U.S. Standard or Metric) selected earlier. The values range from 0.5 to 12 mph (0.8 to 20 kph).

Set Incline Limit (Treadmill only)

Value Range: Full grade range of equipment

(Default: Maximum grade possible)

Select the maximum percent incline that a user can enter when using the equipment. Values range from 0.0 to 15.0.

Hidden Programs (Treadmill only)

Value: Show Programs or Hide Programs

(Default: Hide Programs)

When this option is set to **Show Programs**, the user can select between the Track workout and the Fitness Test. Otherwise, only the Track workout is available.

Remote Speed Control (Treadmill only)

Value: Enable or Disable

(Default: Disable)

When this feature is enabled, the CSAFE SetSpeed command and the CSAFE SetGrade command are available if:

- The treadmill is in the CSAFE "InUse" state.
- The speed or grade values sent are within range.

Autostop Configure (Treadmill only)

Value: On or Off

(Default: On)

Set to **On** to bring the treadmill to a gradual stop when no user is on the equipment. This can occur if a user steps off the equipment during a workout and does not turn it off.

Set Crossramp Auto-level (EFX only)

Value Range: 0 to 20

(Default: 10)

Use this setting to choose a specific ramp incline so that the EFX automatically returns to that incline at the end of a workout session.

Set Resistance Range (Bike only)

Value Range: High, Medium, or Low

(Default: High)

You can set a low, medium, or high base resistance on the recumbent or upright bikes. There are 25 levels of resistance within each base setting, but the base setting affects the overall resistance range. The following ranges are available:

- High: Provides full resistance range.
- Medium: Provides approximately two thirds of the resistance that is available within the high group setting.
- Low: Provides approximately one third of the resistance that is available within the high group setting.

Viewing the Informational Displays

Information Display settings are values that provide you with information about the equipment. Types of information contained in this setting group include, an event (error) log, software and equipment serial numbers, and usage information.

To view the System settings:

1. At the Welcome banner, press **Pause**.



2. Press the following number keys in sequence to enter the password:
6 5
3. Press **OK**.

Use the following table to set up customized Informational Display values.

Table 3. Informational Displays values

Product	Value	Information provided
All	ODOMETER	<p>Correlates to the type of equipment and the standard of units, U.S. or Metric, selected in the programs.</p> <ul style="list-style-type: none"> • Treadmill and AMT: Displays the number of cumulative miles or kilometers logged to date. In addition, the AMT displays the number of vertical strides. • EFX: Displays the number of total strides logged to date. • Bike: Displays the number of total revolutions logged to date.
AMT	BELT USAGE	<ul style="list-style-type: none"> • Belt Stride Count: Tracks the number of strides on equipment. • Stride Count Reset: Reset increases by one each time a reset is performed. • Odometer at Last Reset: Records the odometer reading at the time the belt was changed. The equipment odometer continues to count forward after the belt change.
All	HOUR METER	<p>Displays the number of hours that the equipment has been in use.</p> <p>Note: The equipment tracks the elapsed minutes, but the value that appears is truncated to the nearest full hour.</p>
Treadmill	BELT RATING	<p>Displays the condition of the treadmill's running belt as a number between 0 and 10. If the rating is 0 or 1, you should replace the belt.</p>
All	UPPER BOOT SW PART NUMBER	<p>Upper board application software part number and version.</p>

Product	Value	Information provided
All	UPPER BASE SW PART NUMBER	Displays the upper base application software version.
All	LOWER BASE SW PART NUMBER	Displays the lower application software version.
All	METRICS BOARD	Displays the software number on the Metrics Board.
All	SERIAL NUMBER	Displays the model and type of equipment.
All	USAGE LOG	<ul style="list-style-type: none"> • Displays the number of times each workout has been used and displays the associated cumulative minutes. • Displays the user preferences in workout selection.
All	ERROR LOG	Displays any event codes that may have been detected by the software. For more information, refer to <i>Event Log</i> .

Event (Error) Log

This log holds a maximum of 30 events. After the log reaches 30 events, older events are erased to make room for newer ones. To clear an event from the log, press and hold the **Quick Start** key while the event is displayed.

The event log (sometimes referred to as an error log) contains the following information:

- Event number
- Odometer value when the event occurred
- Hour meter value at the time the event occurred
- Current drawn by the motor and available voltage when the event occurred (treadmill only)

The following table contains a list of events detectable by the software.

Table 4. Event log numbers and descriptions

Event Number	Description of Event
00	Upper PCA memory location event
02	RAM location event
03	EEPROM checksum event
05	Depressed key at power up
09	Lower PCA memory test event
10	Line Frequency out of acceptable range
11	Watchdog (Upper PCA) low voltage power
12	Watchdog (Lower PCA) low voltage power
13	Fan at incorrect speed (version 1 treadmills)
14	Fan fail (Lower PCA)
15	AC input voltage too high
16	AC input voltage too low
17	Dynamic break resistor thermal trip (treadmill only)
18	Dynamic break resistor thermal switch open (treadmill only)
19	Power factor corrector malfunction (treadmill only)
20	Motor will not start, or no motor movement was detected (treadmills only); too many maximum power requests in one second (other equipment)
21	Too many maximum consecutive power requests
22	No motor pulses at start up
23	Motor pulses missing after start up
24	Reduce speed requested, speed is not reducing
25	Lower drive hardware error (treadmill only)
26	Motor pulse width incorrect
27	Too much drive motor current
28	Temperature too high
29	Excessive AC input current
30	Communications event lower board to upper board
31	Incorrect Communications event upper board to lower board

Event Number	Description of Event
32	Communication event upper board to lower board
33	Incorrect communications event lower board to upper board
35	Excessive AC input current (instantaneous; treadmill only)
36	Excessive AC input current (sustained / circuit breaker trip protection; treadmill only)
37	E-STOP error (treadmill only)
40	Lift motion not detected
42	Lift position value out of range
43	Zero switch not found
44	Un-commanded lift motion
45	Lift going in the wrong direction
50	Too much brake (magnet) current
53	Cannot read target, cannot find home switch
54	Target pulses lost during operation
55	Brake home switch activated unexpectedly
62	Vertical sensor failure (AMT only)
70	Belt replacement, lower control board not read (AMT only)
71	Belt replacement, new lower control board (AMT only)
72	Belt replacement, lower control board version unknown (AMT only)
73	Belt replacement, lower control board record bad (AMT only)
74	Belt replacement, lower control board refurbished console (AMT only)
75	Belt replacement, refurbished lower control board (AMT only)
76	Belt replacement, console stride count is less than lower control board (AMT only)
77	Belt replacement, console stride count is greater than lower control board (AMT only)
78	Belt replacement warning (AMT only)
79	Belt replacement required (AMT only)
80	Phase A or B missing (incline control; treadmill only)

Event Number	Description of Event
81	Phase C missing (incline control; treadmill only)
82	Phase A or B missing (speed control; treadmill only)
83	Phase C missing (speed control; treadmill only)
85	No dynamic break resistor detected, or dynamic break resistor is detected as an open circuit, at startup time (treadmill only)
86	Old console detected on new equipment (treadmill only)
87	New console installed on older equipment (treadmill only)
88	Motor temperature too high (treadmill only)

User ID Entry with CSAFE Equipment

This equipment is fully compatible with CSAFE protocols. When the equipment is connected to a CSAFE master device, the user is prompted to press ENTER and begin an identification process. The user ID is displayed as five zeros and indicates the starting point. The following table describes key functions while in CSAFE mode.

Table 5. CSAFE access keys

Keys	Function
Number Keypad	Use the number keys to enter a user ID. Once you have entered the user ID number, press OK to submit the user ID.
CLEAR	Erases individual numbers in the user ID from right to left.
OK	Submits the user ID. Note: User ID entry is bypassed when the user enters five zeros. No workout statistics are recorded.
PAUSE	Resets to the Welcome banner.

A message appears on the display and indicates when the user ID is accepted by the CSAFE master device. Once program selection is complete, the user can begin exercising.

Introducing Users to the P10 Console

CAUTION: Before beginning any fitness program, see your physician for a thorough physical examination. Seek advice from your physician to learn the target heart rate appropriate for your fitness level.

The P10 console offers an easy-to-follow display and multiple workouts to help people meet their exercise needs.

Important: Please review the following sections in this guide with your users before allowing them to use the fitness equipment:

- *Important Safety Instructions*
- *Getting Started*
- *Using the Safety Clip (for treadmill only)*

Using the Touch Heart Rate Feature

Note: Touch heart rate performance may vary based on your physiology, fitness level, age, and other factors. You may experience an erratic readout if your hands are dry, dirty, or oily, or if the skin on your palms is especially thick. Wearing hand lotion can also cause an erratic readout. In addition, make sure that the sensors are clean to ensure proper contact can be maintained.

To use the touch heart rate feature, place the palm of your hands directly on the metal heart rate sensors on the equipment's handlebars. To ensure an accurate heart rate readout, make sure you follow these tips:

- Both hands must grip the sensors for your heart rate to register.
- It takes a number of consecutive heartbeats (15-20 seconds) for your heart rate to register.

- When gripping the sensors, do not grip tightly. Keep a loose, cupping hold. Holding the grips tightly can affect the reading.
- As you work out, your perspiration will help transmit your heart rate signal. If you have difficulty using the handheld grips to determine your heart rate, try the sensors again later in the workout to see if you can obtain a heart rate signal.
- If the touch heart rate feature does not work for you, Precor recommends that you use a chest transmitter strap.

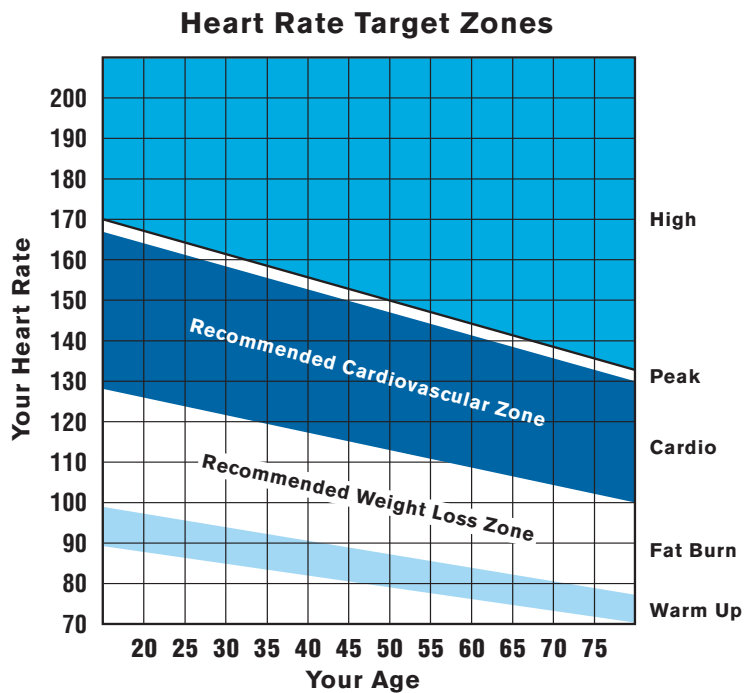

Figure 5: Heart rate target zones

CAUTION: Your heart rate should never exceed 85% of your maximum aerobic heart rate. You can calculate your maximum heart rate using the following formula:

$$\text{Maximum heart rate} = 207 - (\text{your age} \times 0.67)$$

Using a Chest Strap Transmitter

WARNING Signals used by the chest strap transmitter (or heart rate strap) may interfere with pacemakers or other implanted devices. Consult your physician and the manufacturers of your chest strap transmitter and implanted device before using a chest strap transmitter.

Wearing a chest strap transmitter during your workout provides steady heart rate information. For the equipment to detect your heart rate, you must grip the touch heart rate sensors or wear a chest strap transmitter while exercising. In the presence of both touch and wireless data, the touch data takes precedence and will display.

Note: To receive an accurate reading, the strap needs to be in direct contact with the skin on the lower sternum (just below the bust line for women).

To use a chest strap transmitter:

1. Carefully dampen the back of the strap with tap water.
Important: Do not use deionized water. It does not have the proper minerals and salts to conduct electrical impulses.
2. Adjust the strap and fasten it around your chest. The strap should feel snug, not restrictive.
3. Make sure that the chest strap is right-side-up, lies horizontally across, and is centered in the middle of your chest.
4. Test the chest strap placement by checking the heart rate function on the equipment. If a heart rate is registering, your chest strap placement is correct. If the equipment does not register a heart rate, readjust the strap and recheck the heart rate function.

Using the Treadmill Safety Clip

The treadmill is equipped with three different stop functions, which behave as follows:

<i>If the user ...</i>	<i>Then the treadmill belt ...</i>	<i>And the console ...</i>
<p>Pulls on the lanyard attached to the safety clip and trips the restart switch</p> <p>1</p>	<p>Slows to a stop</p>	<p>Shows the words PUSH THE RESET SWITCH. On some console models, an arrow points toward the Restart switch.</p>
<p>Presses down on the red STOP button</p> <p>2</p>	<p>Slows to a stop</p>	<p>Shows that the exercise workout is paused.</p>
<p>Steps off of the running belt for a preset amount of time</p>	<p>Slows to a stop</p>	<p>Shows that the exercise workout is paused.</p>

The restart switch and the red **STOP** button are located just below the console, as shown in the following figure. When the switch is tripped, the button pops up. The treadmill does not operate until the button is returned to its normal position.



Figure 6: Restart switch

Instruct users on how important it is to use the safety clip while exercising on the treadmill, and demonstrate how they should attach it to their clothing near the waistline.

If the restart switch trips during exercise, perform the following steps:

1. Reattach the safety clip if necessary.
2. Press the restart switch down until it clicks, returning it to its normal position.

Note: If the restart switch trips, all information about the current workout is deleted.

3. Start the workout from the beginning, reducing the time as needed to account for the amount of exercise that has been completed.

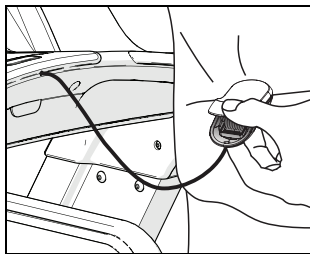

Figure 7: Attaching the safety clip

Tip: The small, flexible tab underneath the restart switch is designed for storage of the safety clip. When the treadmill is not in use, attach the safety clip to the tab as shown in the following figure.

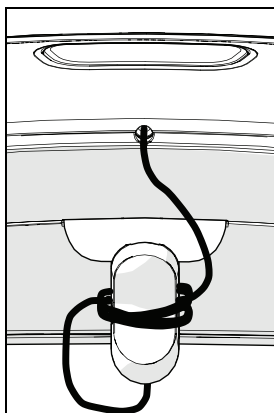

Figure 8: Safety clip storage

Treadmill Auto Stop™ (Automatic Stop) Function

Important: *The default setting for this feature is ON. An administrator can turn off this feature in the System Settings; however, Precor recommends it remain ON.*

The Auto Stop™ (Automatic Stop) feature is designed to bring the treadmill to a gradual stop when it is not in use. This might occur if a user steps off the treadmill before the end of a workout and leaves the treadmill running.

60 seconds after a treadmill workout starts, or 30 seconds after it resumes, the equipment begins Auto Stop monitoring. If a user is detected, then no message appears, and the selected workout continues.

If no user is detected after an additional 30 seconds, the console displays the message **NO USER DETECTED, STOPPING IN 10 SECONDS** as notification of the pending stop. During the display of this message, a ten second countdown begins. If a user does not override the countdown, the belt comes to a gradual stop after the countdown is complete.

Note: Users weighing more than 50 pounds (22.7 kg) are detected within the speed and position limits of the feature. Users weighing less than 50 pounds (22.7 kg) may not be detected depending on their speed and location. Always be aware of the console's instructions and follow them for proper operation.

Starting a Workout

CAUTION: If you are using a treadmill, be sure to attach the security clip to your clothing before starting your workout.

The equipment is in the Welcome state when the words **SELECT A WORKOUT OR PRESS QUICKSTART TO BEGIN** scroll across the scrolling text display.

If the equipment is connected to CSAFE, the words **SELECT A WORKOUT, PRESS QUICKSTART, OR ENTER TO BEGIN** scroll across the text display.

If anything else appears on the screen, press **Pause** to display the Welcome banner.

From this screen, there are two ways to begin a workout:

- Press **Quick Start™**.
This action launches the Manual program. Calculations, such as calories used, are based on a 150-lb (68 kg), 35-year old person.
- Press one of the preset workout buttons.

When a user reaches the club time limit during a workout, the words **number MINUTE CLUB TIME LIMIT REACHED, WORKOUT ENDING** (where *number* is the number of minutes set as the club time limit) appear in the text display.

Starting a Preset Programmed Workout

Preset workouts are a great way to tailor your workouts to your fitness goals, stay challenged, and add variety to your sessions. These workouts are arranged in the following categories:

- Manual
- Heart Rate
- Interval
- Weight Loss
- Variety
- Performance

Pausing and Resuming an Exercise Session

When you interrupt a workout, the equipment responds in one of two ways, depending on how it is powered.

Paused (Externally Powered Equipment)

When the session is paused, the belt speed is slowly reduced to zero, or the resistance is slowly reduced to the minimum. The lift motor is turned off leaving the incline or crossramp at its current position. Data entry is canceled.

When you press **Pause** on all non-treadmill equipment, it displays the summary screen with your workout metrics. After displaying the summary, it returns to the Welcome screen.

Pending Shutdown (Self-Powered Equipment)

On self-powered machines, the paused state is equivalent to the pending shutdown state. When you stop working out, the equipment begins a 30 second countdown.

The accumulated metrics (e.g., time, strides, distance, calories) hold their current values and do not change. Data entry may not be started.

To restart the program, begin working out again. The resistance is reset to what it was when the program was paused.

If the equipment remains inactive for more than 30 seconds, the power is lost and the equipment bypasses the workout summary screen.

Ending a Session

Cooling down is an important aspect of your workout because it helps reduce muscle stiffness and soreness by transporting excess lactic acid out of the working muscles. In addition, a three to five minute cool down allows your heart rate to return to its normal, resting state.

At the end of your workout, a Summary screen displays your average heart rate during your workout and your accumulated workout metrics.

If you performed a fitness test exercise program, an initial message presents a fitness score.

The next two messages display the user's average and maximum heart rate during the session. These messages are only displayed if heart rate data was acquired during the session, i.e., a valid heart rate number was displayed at least once during the session.

The summary state times out in two minutes, causing a return to the Welcome banner. If the machine is in a CSAFE Finished state then the summary state must last for at least the CSAFE timeout value, typically 10 seconds or less. If it has not lasted that long, then before returning to the Welcome banner, the word **RESETTING** appears until the CSAFE finished state ends.

Three different types of metrics are captured during a workout.

Controlled Metrics can be set and changed. They include:

- Resistance Level (AMT, EFX, bike)
- Speed (treadmill)
- Incline (treadmill)
- Crossramp (EFX)

Current Performance Metrics describe the intensity of a workout in real time. They include:

- Pace (treadmill)
- Heart Rate
- Speed (bike)
- Revolutions/Minute (bike)
- Strides/Minute (AMT, EFX)
- Watts (bike)

Accumulated Metrics describe the overall performance throughout the entire exercise session. They include:

- Time Elapsed
- Time Remaining
- Distance
- Calories
- Time (bike)
- Total Strides (EFX)
- Average Speed (treadmill)

Workouts

Your fitness equipment includes a wide selection of workouts that are carefully designed to make sure you get the best results out of every workout.

The human body is extremely efficient. If it makes the same motion regularly over many days or weeks, it learns to make that motion with less and less effort. This process, called *muscle adaptation*, has one drawback—the longer you stick to the same workout, the less good that workout does you.

To prevent muscle adaptation from setting in as you work out, try different kinds of workouts on different days. By keeping your muscles guessing, you'll keep your energy use up, promoting faster weight loss and better conditioning.

The workouts in the following table are available on units equipped with the P10 console.

Table 6. P10 Console Workouts

Console Key	Workout	AMT	EFX	Treadmill	Bike
Weight Loss	Weight Loss	✓	✓	✓	✓
Heart Rate	Basic Heart Rate Control (HRC)	✓	✓	✓	✓
Performance	Track			✓	
	Hill Climb	✓			✓
	Cross Training Workouts		✓		
	Fitness Test			✓	
Variety	Random	✓		✓	✓
	Gluteal Workouts		✓		
Interval	1-1 and 1-2 Interval	✓	✓		✓
	Custom Interval			✓	
Manual	Manual	✓	✓	✓	✓

The following listing describes these workouts.

Weight Loss Key

Pressing the **Weight Loss** key scrolls through the workouts that are designed to encourage weight loss and aerobic conditioning.

The American College of Sports Medicine[®] recommends that adults get at least 30–60 minutes of moderately intense exercise five days a week. The Weight Loss workout provides a structured and time-based aerobic challenge designed to help you reverse or prevent weight gain.

The total time for this workout is fixed at 28 minutes. It consists of alternating four-minute work and rest intervals. During the work intervals, you can change the resistance at any time.

Training tip: For best results, wear a heart rate monitor and maintain a target heart rate that is between 50% and 70% of your maximum heart rate.

Heart Rate Key

Pressing the Heart Rate key selects the Basic Heart Rate Controlled (HRC) workout, which monitors your heart rate to guide you through a moderate intensity program that is optimal for aerobic conditioning. To use this workout, you must either wear a chest strap sensor (recommended) or maintain continuous contact with the handheld sensor grips.

Note: You cannot switch to this workout during an exercise session.

During the workout, your target heart rate is based on the following calculation:

Target heart rate = 70% × (207 - (0.67 × your age))

The equipment adjusts intensity settings to maintain your target heart rate while you work out.

When a heart rate signal is not received, the metrics displays remain blank. If this happens, recheck your hand grip on the handheld sensors or the placement of your chest strap.

Training tip: This program offers a coaching benefit for new and returning users who are learning how to maintain a moderate, steady exertion level throughout their workouts.

Performance Key

Press the **Performance** key repeatedly to select a workout that conditions and tests the body's muscular and aerobic performance.

Note: On treadmills, a fitness test option is also available. A technician at the fitness facility must activate the fitness test before you can use it. After the test has been activated, you can scroll between the Track and Fitness Test workouts by pressing the **Performance** key repeatedly.

Track

This workout is largely identical to the Manual workout; there are no preset intensity levels, so you can adjust the levels as you work out. However, in place of the normal intensity graph, a diagram depicting an oval running track appears on the lower display. A blinking LED shows where you are in your current lap, and each lap is equal to 440 yards (400 meters).

Training tip: Challenge yourself by adjusting your training parameters regularly for the best results.

Hill Climb

This workout simulates a walk, run, or ride up a long grade and down a shorter one. It engages a wide range of muscle groups by adjusting the resistance, CrossRamp, or both to deliver a hill climbing experience. You can change these settings at any time, and your changes will affect the intensity of the rest of your workout.

Note: On the EFX, the console prompts you to pedal backward during part of the workout.

Training tip: Incorporating hill climb workouts into your regular cardio schedule will keep your workouts varied and help build lower body muscle strength.

Cross Training Workouts

This workout delivers true training variety and muscular engagement by adjusting the resistance and incline continuously to simulate the dynamic terrain of an outdoor run.

The CrossRamp setting is preprogrammed in each of these workouts, but you can change it or the resistance setting at any time. Your changes are applied to the levels for the remainder of your workout, and the columns in the workout profile show the changed CrossRamp levels.

Training tip: Advanced users can engage their core stabilizer muscles more thoroughly by taking their hands off the handlebars throughout the workout.

Fitness Test

Fitness tests evaluate your body's overall fitness in terms of its aerobic capacity. During the warmup stage of the test, you can adjust your starting resistance settings. After that, you complete a series of stages of increasing intensity. Based on your progress through these stages and the changes in your heart rate as you complete them, the equipment calculates your fitness score at the end of the test.

On treadmills, the Gerkin Fitness Test compares your fitness level with the official fitness standards of the International Association of Firefighters (IAFF). This test is written using the Gerkin Protocol, which is the basis for the official IAFF fitness test and part of their Wellness and Fitness Initiative.

The treadmill ends the test prematurely if any of the following things happen:

- The equipment cannot detect your heartbeat.
- Your heart rate exceeds 85% of your maximum safe rate for 15 seconds or more.
- Your heart rate changes too quickly.
- You press the STOP switch or pull on the safety clip lanyard.

Important: For best results, sit and rest for at least five minutes before you take the test.

Training tip: To see how your performance level increases with exercise over time, try taking the fitness test as soon as possible after you begin your exercise program. Then, as you keep working out, take the fitness test from time to time and watch your results improve.

The following tables show how to interpret your test score.

Table 7. Fitness score categories for women

Age in Years	Low Fitness	Medium Fitness	High Fitness
20-39	28 or below	28-34	34 or above
40-49	26 or below	26-32	32 or above
50-59	24 or below	24-29	29 or above
60 or over	22 or below	22-27	27 or above

Table 8. Fitness score categories for men

Age in Years	Low Fitness	Medium Fitness	High Fitness
20-39	35 or below	35-43	43 or above
40-49	32 or below	32-40	40 or above
50-59	29 or below	29-37	37 or above
60 or over	24 or below	24-32	32 or above

Variety Key

Pressing the **Variety** key selects a random or specialized workout designed for the fitness equipment you are using.

Random

Variety (for both the muscles and the mind) is the key to continued success for every exercise goal. The Random workout delivers a different training profile every time you select it. The one-minute segments that appear in the workout profile maintain a set incline that you can override.

Training tip: Your body will respond differently to each workout. The best way to evaluate and quantify the effectiveness of each exercise session is to wear a chest strap or use the touch-sensitive grips during your training sessions.

Gluteal Workouts

Strong glutes contribute to better posture, improved spine and hip stabilization, and reduction in lower body injuries at the hips, knees and ankles. These workouts target your thighs and glutes as they gradually increase in intensity, but you can modify the intensity levels at any time.

On EFX models, the workout prompts you to reverse direction after 25%, 50%, and 75% of the total time. At these points, you will see text messages on the console that remind you to change direction.

Training tip: To increase your core activation (the effort expended by your torso and gluteal muscles) during your workout, take your hands off the machine handles or handrails while maintaining an upright posture.

Interval Key

Interval workouts help exercisers improve strength, endurance, aerobic and anaerobic fitness. They alternate short bursts of high intensity activity with recovery periods. Pressing the **Interval** key selects the available interval workout.

Note: On the AMT, two different interval workouts are available. Press the **Interval** key repeatedly to scroll between the available workouts.

1-1 and 1-2 Interval

The 1-1 Interval workout is designed to raise and lower your heart rate in a repeating fashion for a user-defined period of time by alternating rest and work intervals of two minutes each. Likewise, the 1-2 Interval workout alternates two minutes of rest with four minutes of work.

Training tip: You can tailor your rest and work period intensity further by adjusting either of the intensity settings at any time. The equipment remembers these preferences for each upcoming interval.

Custom Interval

The Custom Interval workout is similar to the Interval workout. However, before you begin, you must specify the length of the rest and work intervals. Use either the arrow keys or the keypad to select a duration between 1 and 30 minutes, then press **OK** to enter your selection. After you have entered both durations, your workout begins.

Training tip: Depending on your fitness level and workout goals, you can set your recovery period as low as one minute between work intervals. For the work intervals themselves, you can set any duration between 1 and 30 minutes. Customizing the proportions of your work and rest intervals based on your unique training objectives will speed your progress toward your performance goals.

Manual Key

The workout available through the **Manual** key motivates you by allowing you to define and track your exertion levels throughout your exercise session.

Training tip: As you progress through your workout, each segment of the profile reflects the last change you made to the intensity settings. Challenge yourself by adjusting your training parameters regularly for the best results.

Maintenance

To keep the equipment functioning properly, perform the minor maintenance tasks in this section at the intervals suggested. Failure to maintain the equipment as described in this section could void the Precor Limited Warranty.

DANGER To reduce the risk of electrical shock, always disconnect the equipment from its power source before cleaning it or performing any maintenance tasks. If the equipment uses an optional power adapter, disconnect the adapter.

Cleaning the Console and Display

The console requires little maintenance once installed. Precor recommends that you clean the console before and after each exercise session.

To remove dust and dirt from the console:

- Wipe all exposed surfaces with a soft cloth that you have moistened with a solution of 30 parts of water to 1 part of Simple Green® (for more information, visit www.simplegreen.com).

Important: Do not use any acidic cleaners. Doing so will weaken the paint or powder coatings and void the Precor Limited Warranty. Never pour water or spray liquids directly on the console or console's screen.

- It is important to avoid using any corrosive chemicals on the console or screen.
- Always dampen the cloth and then clean the screen. Be sure to spray the cleaning liquid onto the cloth, not the console, so that drips do not seep into the console.
- Apply the cleaner with a soft, lint-free cloth. Avoid using gritty cloths.

Checking and Resetting the Active Status Light (Treadmill Only)

Experience Series treadmills manufactured after June 2014 include many improvements in design, function, and usability. One of those improvements is the status indicator light at the front of the treadmill hood, which gives a club owner or technician an easy way to check up on the condition of the treadmill.

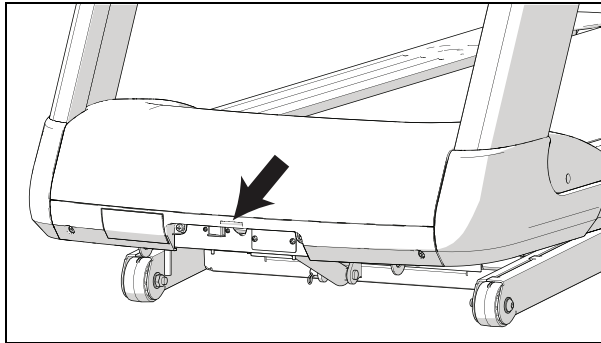

Figure 9: Status light location

Table 9. Active status light appearances and their meanings

Status light appearance	Meaning	Action required
Steady (solid) blue	The treadmill is operating normally and does not currently need maintenance.	None.
Pulsing blue	The treadmill is due for scheduled maintenance (P80 console only), or the treadmill belt needs to be replaced (except for 230 V models).	Perform the needed maintenance, then reset the status light.
Steady (solid) yellow	The treadmill has detected and recovered from an error. It can still be used, but some functions may not be available.	Refer to the console's event log for more information.
Pulsing yellow	The treadmill has detected an error, has been unable to recover from the error, and has taken itself out of service.	Power-cycle the treadmill (switch it off, wait 30 seconds, then switch it on again). If the error occurs again, check the console's event log for more information, then contact Precor Customer Support.

Important: Contact Precor Customer Support before running any of the diagnostic tests on the Hardware Validation menu.

To review and reset the status of the treadmill:

1. At the Welcome banner, press the **Pause** key, then enter the following digits on the keypad:
5 1 7 6 5 7 6 1
2. Use the up and down arrow keys to scroll through the menu names until **HARDWARE VALIDATION** appears.
3. In the Hardware Validation menu, use the up and down arrow keys to scroll through the menu options until **ACTIVE STATUS LIGHT** appears, then press **OK** again.
4. Press and hold the **Quick Start** key until the status light returns to a steady blue color.
5. Press the **Pause** key to return to the Welcome banner.

Note: If the status light is steady yellow, you can also clear it by reviewing and clearing the entries in the event log (refer to *Viewing the Informational Displays*).

To adjust the brightness of the status light:

1. At the Welcome banner, press the **Pause** key, then enter the following digits on the keypad:
5 1 7 6 5 7 6 1
2. Use the up and down arrow keys to scroll through the menu names until **HARDWARE VALIDATION** appears.
3. In the Hardware Validation menu, use the up and down arrow keys to scroll through the menu options until **AS LIGHT BRIGHTNESS** appears, then press **OK** again.
4. Scroll through the available settings (**LOW**, **MED**, and **HIGH**) to select the brightness level you want, then press **OK**.

Changing the Belt (AMT Only)

The AMT uses belts to provide motion. These belts eventually wear and must be replaced.

When the belt stride count reaches 90 million, the message **BELTS MUST BE CHANGED SOON** scrolls on the Welcome screen. While this message appears, the AMT operates normally.

Important: *If this message displays on your AMT, please contact Precor Customer Support for assistance.*

When the belt stride count reaches 100 million (and the belt has not been changed), the message **BELTS CHANGE REQUIRED** scrolls continuously on the Welcome screen. The input keys are not functional and the user cannot enter values or begin a workout until the belts are changed. Please contact Precor Customer Support to schedule a belt change.

Notes:

Notes:



Precor Incorporated
20031 142nd Avenue NE
P.O. Box 7202
Woodinville, WA USA 98072-4002



P10 OM 302291-112 rev C, en
January 2015