

Product Owner's Manual

Commercial Products

Treadmills:

- 946i
- 956i
- 966i

Ellipticals:

- EFX546i
- EFX556i
- EFX576i

Cycle:

- 846i

Climber:

- 776i



Important Safety Instructions

When using Precor equipment, always take basic precautions, including the following:

- Read all instructions before using the equipment. These instructions are written to educate patrons and other users in the proper use of the equipment.
- Other sections in this manual provide more details of safety features. Be sure to read these sections and observe all safety notices.
- Before beginning any fitness program, make sure all users see a physician for a complete physical examination.

Il est conseillé de subir un examen médical complet avant d'entreprendre tout programme d'exercice. Si vous avez des étourdissements ou des faiblesses, arrêtez les exercices immédiatement.

DANGER Before cleaning it, always unplug the equipment from its power source to reduce the risk of electric shock. Before cleaning self-powered equipment, disconnect the optional power adapter.

WARNING To reduce the risk of burns, fire, electric shock, or injury, take the following precautions:

- Do not allow children or people unfamiliar with its operation on or near the equipment. Do not leave children unsupervised around the equipment.
- Never leave the equipment unattended when it is plugged in. Unplug the equipment from the power source when it is not in use, before cleaning it, and before providing authorized service.
Note: The optional power adapter is considered an electrical power source for self-powered equipment.
- Keep all electrical components away from liquids to prevent shock.
- Assemble and operate the equipment on a solid, level surface. Locate the equipment a few feet from walls or furniture.
- Maintain the equipment in good working condition. Refer to *Maintenance*.
- If you plan to move the equipment, obtain help and use proper lifting techniques. For more information, refer to *Moving the Equipment*.
- Use the equipment only for its intended purpose as described in this manual. Do not use accessory attachments that are not recommended by the manufacturer, as such attachments may cause injuries.

- Never operate the equipment if it is damaged, not working properly, when it has been dropped, or has been immersed in water. Return the equipment to a service center for examination and repair.
- Keep the power cord or optional power adapter and plug away from heated surfaces.
- Do not operate the equipment where aerosol (spray) products are being used or where oxygen is being administered.
- Do not use outdoors.
- Do not attempt to service the equipment yourself except to follow the maintenance instructions found in this manual.
- Never drop or insert objects into any opening. Keep hands away from moving parts.
- Do not set anything on the stationary handrails or handlebars, display console, or covers. Place liquids, magazines, and books in the appropriate receptacles.

Safety Code

The club owner or manager has the option to enable the safety code. The code involves entering four number keys in sequence. If the correct keys are not pressed within two minutes, further user access is denied. For more information, refer to *Treadmill Safety Features* and *Club Features*.

Safety Approval

When identified with the ETL-c logo, the equipment has been tested and conforms to the requirements of CAN/CSA-E-335-1/3-04, EN 60335-1: 2002 Safety of Household and Similar Electrical Appliances. This equipment is a Class S/B or C certified machine according to applicable EN957 standards.

Educating Users

Take time to educate users on the safety instructions found in both the *User's Reference Manual* and *Product Owner's Manual*.

Explain to your club or facility patrons that they should:

- Hold onto a stationary handrail or handlebar while stepping onto the equipment or when getting comfortably seated on the cycle.
- Face the display at all times.
- Hold on to a stationary handrail or handlebar with one hand whenever reaching with the other hand to touch the display keys.
- On treadmills: straddle the running belt and attach the safety clip to clothing at waist level before touching the display.

Important: For safety, make sure users step onto the running belt while it is moving at or below 1 mile per hour (1 kilometer per hour).

Hazardous Materials and Proper Disposal

The self-powered equipment has an internal battery which contains materials that are considered hazardous to the environment. Proper disposal of the battery is required by federal law.

If you plan to dispose of your equipment, contact Precor Commercial Products Customer Support for information regarding battery removal. Refer to *Obtaining Service*.

Product Recycling and Disposal

This equipment must be recycled or discarded according to applicable local and national regulations.

Product labels, in accordance with European Directive 2002/96/EC concerning waste electrical and electronic equipment (WEEE), determine the framework for the return and recycling of used equipment as applicable throughout the European Union. The WEEE label indicates that the product is not to be thrown away, but rather reclaimed upon end of life per this Directive.

In accordance with the European WEEE Directive, electrical and electronic equipment (EEE) is to be collected separately and to be reused, recycled, or recovered at end of life. Users of EEE with the WEEE label per Annex IV of the WEEE Directive must not dispose of end of life EEE as unsorted municipal waste, but use the collection framework available to customers for the return, recycling, and recovery of WEEE. Customer participation is important to minimize any potential effects of EEE on the environment and human health due to the potential presence of hazardous substances in EEE. For proper collection and treatment, refer to *Obtaining Service*.

Radio Frequency Interference (RFI)

Federal Communications Commission, Part 15

This equipment has been tested and found to comply with the limits for a Class A digital device, pursuant to Part 15 of the FCC Rules. These limits are designed to provide reasonable protection against harmful interference in a commercial installation. The equipment generates, uses, and can radiate radio frequency energy and, if not installed and used in accordance with the owner's manual instructions, may cause harmful interference to radio communications.

WARNING *Per FCC rules, changes or modifications not expressly approved by Precor could void the user's authority to operate the equipment.*

Industry Canada

This Class A digital apparatus complies with Canadian ICES-003.

Cet appareil numérique de la classe A est conforme à la norme NMB-003 du Canada.

ATTENTION: Haute Tension
Débranchez avant de réparer

European Applications

This product is compliant to:

- 2004/108/EC Electromagnetic Compatibility Directive.
- 2006/95/EC Low Voltage Directive.
- 2002/95/EC Restriction of Hazardous Substances Directive.

This product conforms to the requirements of the European Council Directive 89/336/EEC, 2004/108/EC Electromagnetic Compatibility and has been tested to the following standards:

- EN55022, Limits & Methods of Measurement of Radio Interference, Information Technology Equipment.
- EN55024, Immunity of Information Technology Equipment.

This product also conforms to the requirements of the European Council Directive 73/23/EEC, 2006/95/EC Low Voltage Directive and has been tested to the following standard:

- IEC 335-1, EN60335-1 Safety of Household and similar Electrical Appliances.

Treadmill Grounding Instructions

The treadmill must be grounded. If the equipment malfunctions or breaks down, grounding provides a path of least resistance for electric current, which reduces the risk of electrical shock. The treadmill has a power cord having an equipment-grounding conductor and a grounding plug. The plug must be inserted into an outlet that is properly installed and grounded in accordance with all local codes and ordinances. Failure to properly ground the treadmill could void the Precor Limited Warranty.

DANGER Improper connection of the equipment-grounding conductor can result in a risk of electric shock. Check with a qualified electrician or service person if you are in doubt as to whether the equipment is properly grounded. Do not modify the plug provided with the treadmill. If it does not fit the outlet, get a proper outlet installed by a qualified electrician.

120 V and 240 V Equipment Designated for U.S. Markets

The treadmill must be connected to a dedicated, grounded circuit. A 20-amp dedicated circuit is recommended. The equipment's grounding plug looks like the plug shown in one of the following figures. The power outlet must have the same configuration as the plug. No adapter should be used with this product.

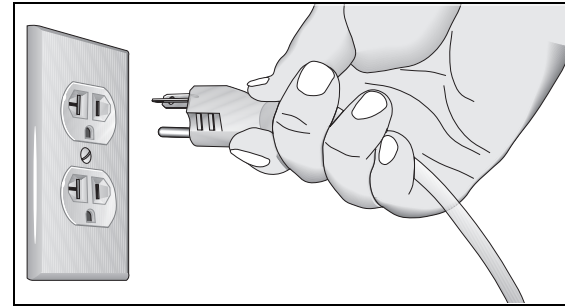

Figure 1: 120-volt power plug

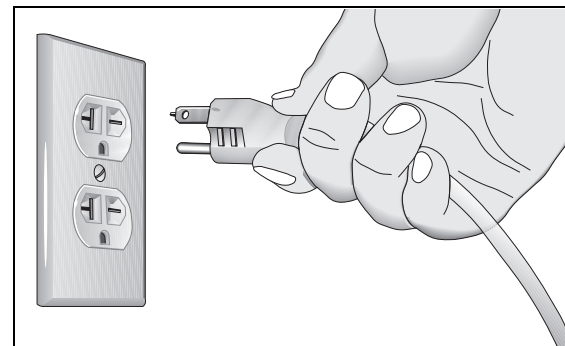

Figure 2: 240-volt power plug

Obtaining Service

You should not attempt to service the equipment except for maintenance tasks described in this manual. For information about product operation or service, see the Precor web site at www.precor.com. Should you need more information regarding customer support numbers or a list of Precor authorized service centers, visit the Precor web site at www.precor.com/corp/contact.

For future reference, write the model, serial number, and date of purchase for all your equipment in the space provided. The serial number is printed on a label located near the power cord connection (treadmills) or receptacle (self-powered equipment).

Model #: _____	Base Serial #: _____
	Display Serial #: _____
	Date purchased: _____
Model #: _____	Base Serial #: _____
	Display Serial #: _____
	Date purchased: _____
Model #: _____	Base Serial #: _____
	Display Serial #: _____
	Date purchased: _____
Model #: _____	Base Serial #: _____
	Display Serial #: _____
	Date purchased: _____

Table of Contents

Important Safety Instructions.....	1	Choosing a Language.....	20
Safety Code.....	2	Selecting a U.S. Standard or Metric Display.....	20
Safety Approval	2	Setting an Exercise Session Time Limit.....	21
Educating Users	3	Setting a Pause Time Limit.....	22
Hazardous Materials and Proper Disposal.....	3	Setting a Cool-Down Time Limit	22
Product Recycling and Disposal	3	Treadmill: Determining the Club Speed Limit	23
Radio Frequency Interference (RFI).....	4	Treadmill: Setting an Incline Limit	23
European Applications.....	4	Treadmill: Accessing Performance Programs.....	24
Treadmill Grounding Instructions	5	Treadmill: Changing Remote Control Access.....	25
Obtaining Service	6	EFX: Changing the Auto-Level Setting.....	26
Treadmill Safety Features	8	Cycle: Setting a Resistance Range.....	27
Entering the Safety Code.....	8	Creating a Custom Program	28
Using the Safety Clip.....	8	Informational Displays	29
Turning the Treadmill On and Off.....	9	User ID Entry with CSAFE Equipment.....	32
Weight Limit	9	Maintenance.....	33
Location.....	9	Daily Inspection	33
Self-Powered Features.....	10	Daily Cleaning.....	33
Informational Displays Prior to Shutdown.....	10	EFX: Cleaning the Ramp.....	34
Symptoms of a Low Battery.....	11	Storing the Chest Strap	34
Using the Optional Power Adapter.....	11	Treadmill: Checking the Alignment of the Running Belt	35
The Optional Power Adapter Kit.....	12	Treadmill: Adjusting the Running Belt.....	36
Replacing the Battery.....	12	Upright Cycle: Adjusting the Seat Tilt.....	37
Club Features.....	13	Recumbent Cycle: Realigning the Seat.....	38
Club Programming Tips.....	14	Moving the Equipment.....	39
Accessing Club Programming Mode and		Long-Term Storage	39
Changing the Settings	16	Precor Commercial Equipment	
Treadmill: Selecting Safety Code Protection.....	19	Limited Warranty.....	41

Treadmill Safety Features

Before allowing users on Precor equipment, review the *Important Safety Instructions* found at the beginning of this manual. You should also teach your patrons how to safely use the equipment following the guidelines in *Educating Users*.

Entering the Safety Code

When the equipment is shipped from the factory, the safety code protection feature is disabled. If you wish to enable the safety code, refer to *Club Features*. Inform users that the equipment requests a safety code to help prevent unauthorized use. When users select a program or press QUICKSTART at the PRECOR banner, the following prompt appears:

ENTER SAFETY CODE TO UNLOCK MACHINE

Users have two minutes to press the following number key sequence and continue their workout: 1, 2, 3, 4.

Important: Tell users to hold onto the handrail with one hand before entering the safety code with the other hand.

If the correct keys are pressed, the program selection process begins. If the code is incorrect, the display prompts the user to reenter the code after a 2-minute time out.

Note: On the treadmill, a 3-second countdown appears on the display, and then the running belt starts moving. Refer to *Workout Options* in the *User's Reference Manual*.

Using the Safety Clip

Instruct users how important it is to use the safety clip while exercising on the treadmill. Instruct them on how to attach it to their clothing near their waistline. If any complications occur, a strong tug on the safety lanyard will stop the running belt.

If the safety switch trips while users are exercising, have them reattach the safety clip, press the SPEED up key or QUICKSTART and reenter the safety code, if necessary.

Note: The treadmill retains users' workout statistics if they resume their workout within the limit set for pause mode.

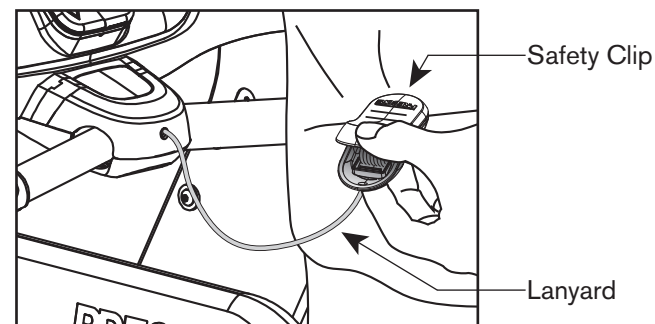

Figure 3: Attaching the safety clip

Turning the Treadmill On and Off

To turn the treadmill On and Off, use the power switch located beneath the hood, near the power cord receptacle.

***Important:** When it is not being used, turn the treadmill Off.*

Weight Limit

You should not allow runners over 350 lb. (160 kg) or walkers heavier than 500 lb. (225 kg) on the treadmill.

Location

It is important to keep the area around the treadmill open and free from encumbrances such as other equipment. The minimum space requirement needed for user safety and proper maintenance is three feet wide by six feet deep (one meter wide by two meters deep), directly behind the running belt.

Self-Powered Features

On self-powered equipment, the battery initializes and displays the Precor banner when a user starts exercising. A minimum rate of motion must be maintained for the banner to appear, as shown in the following table. When a person meets the requirements, the power that is generated allows the equipment to function properly.

Table 1. Minimum requirements for operation

Equipment	Rate of Motion
AMT	56 strides per minute (SPM)
EFX	40 strides per minute (SPM)
Climber	30 steps per minute
Cycle	20 revolutions per minute (RPM)

Informational displays appear when the battery is low or when the rate of motion drops below the minimum requirements. The display explains what to do to retain power. If the messages are ignored, the equipment begins shutdown procedures to maintain the charge of the battery. Refer to *Informational Displays Prior to Shutdown*.

An optional power adapter can be purchased and provides sustained power to the equipment. If you plan to change the club settings, the power adapter is highly recommended. To purchase the optional power adapter, check with your dealer. Refer to *Obtaining Service*.

Informational Displays Prior to Shutdown

The equipment saves its battery charge by moving into a shutdown mode. If the user does not maintain the minimum rate of motion, a 30-second shutdown process begins.

Dots appear in the display and all key presses are ignored. If no movement is detected or the rate of motion remains below the minimum, the dots steadily disappear as the countdown continues.

Note: The user can resume exercising if he or she begins before the countdown period elapses.

Important: *If the equipment is connected to a CSAFE master device, a slightly different scenario occurs. When ten seconds remain before the equipment shuts off, the exercise session ends. **RESETTING** appears in the display while the equipment disconnects from the CSAFE master device. All key presses are ignored.*

Symptoms of a Low Battery

If no one has used the equipment for an extended period of time, the battery may need recharging.

Symptoms of a low battery include:

- A flickering or erratic display
- User and program information is lost once the user stops exercising. No workout summary or notification of pending shutdown occurs.

Important: *To maintain a constant power source, use the optional power adapter.*

Using the Optional Power Adapter

After connecting the power adapter to the equipment, plug the opposite end into the appropriate power source 120 V or 240 V.

CAUTION: When the optional power adapter is in use, make sure that the power supply cord does not create a safety hazard. Keep it out of the way of traffic and moving parts. If the power supply cord or power conversion module is damaged, it must be replaced.

The display functions differently when the power adapter is connected. Because the power adapter provides a constant source of power, a user can pause for brief periods without initiating shutdown procedures. When the pause time limit expires and the user has not resumed exercising, the display returns to the Precor banner. Refer to *Setting a Pause Time Limit*. To learn how to install the power adapter, refer to *The Optional Power Adapter Kit*.

The Optional Power Adapter Kit

If you purchase the optional power adapter, you must also purchase the internal cable kit. The kit supplies the cable, bracket, and fasteners that connect the power adapter to the lower electronics board.

CAUTION: The internal cable kit must be installed by authorized service personnel. Do not attempt installation on your own as you could void the Precor Limited Warranty. For more information, refer to *Obtaining Service*.

Once the internal cable kit is installed, you can plug the optional power adapter into the equipment. Plug the opposite end into the appropriate power source for your equipment 120 V or 240 V. Review the safety instructions found at the beginning of this manual before using the power adapter.

Replacing the Battery

The equipment's battery is built to last for a long time. However, if you feel that the battery may need replacing, check with an authorized service technician. Refer to *Obtaining Service*.

CAUTION: The battery stored inside the equipment contains hazardous materials and must be disposed of according to Hazardous Waste Regulations. Refer to *Hazardous Materials and Proper Disposal*.

Club Features

These next few pages explain how to customize the equipment for your club or facility and view useful product information. All these features remain hidden to the patrons and can only be accessed using special key presses. Read this section if you want to:

- Enable or disable the safety code (treadmill)
- Change the display to a different language
- Change the display to show U.S. standard or metric measurements
- Set the maximum exercise and pause times
- Set a cool-down time limit
- Set the maximum speed and incline (treadmill)
- Enable or disable hidden programs or remote access (treadmill)

- Change the auto-level setting (EFX)
- Set the resistance range (cycle)
- Customize a program
- View the odometer
- Display the number of hours the equipment has been in use
- View the software versions and part numbers
- Display the serial number
- Check the program usage and error logs

Note: To review the club programming prompts and factory default settings that can be changed through club programming mode, refer to the following table.

Club Programming Tips

- Always start at the Precor banner.
- Electrical power must be supplied. For self-powered equipment, a constant power source is available if you use the optional power adapter, otherwise you will have to maintain the minimum rate of motion. Refer to *Self-Powered Features*. If you plan to program self-powered equipment, purchasing the optional power adapter is highly recommended.

Note: If you do not use the optional power adapter during club programming mode, and the rate of motion falls below the minimum requirements, no warning is given when the equipment moves into its 30-second shutdown procedure.

- The club programming mode is accessed by pressing the RESET key at the Precor banner. The remaining key presses must occur quickly and without pause.
Note: Treadmill keys that can be used interchangeably in club programming mode are: PAUSE/RESET and the red STOP button. On the EFX, the CLEAR and ENTER keys perform specific functions, but the number keypad is disabled once you enter club programming mode.
- The changes made in club programming mode become the default settings whenever the display resets to the Precor banner.

Table 2. Club custom features and settings

Equipment	Club Programming Prompt	Factory Default Setting	Changes you can make
Treadmill	SAFETY CODE	Disabled	An <i>enabled</i> safety code requires a 4-digit entry code before users can access any exercise programs.
All *	SELECT LANGUAGE	English	Several languages affect the display prompts. Choose one.
All *	SELECT UNITS	U.S.	Two standard units of measure affect the display prompts. Choose between U.S. or Metric.
All *	SET MAX WORKOUT TIME	60 minutes	Exercise session time limits range from 1 to 240 minutes. NO LIMIT is accessible beyond 240 minutes.
All *	SET MAX PAUSE TIME	120 seconds	Pause time limits range from 1 to 120 seconds (2 minutes). Restrictions exist for self-powered units.
All *	SET COOL DOWN TIME	5 minutes	Cool-down time limits range from 0 to 5 minutes.
Treadmill	SET SPEED LIMIT	Maximum speed available.	Refer to <i>Treadmill: Determining the Club Speed Limit</i> .
Treadmill	SET INCLINE LIMIT	Maximum grade possible.	Refer to <i>Treadmill: Setting an Incline Limit</i> .
Treadmill †	HIDDEN PROGRAMS	Hide programs	Two options are available: Show Programs or Hide Programs. Choose one.
Treadmill	REMOTE SPEED CONTROL	Disabled	A computer must be connected through the CSAFE port to enable this feature and change the speed or incline for a specific user.
EFX576i, EFX546i	SET CROSSRAMP AUTO - LEVEL	Mid-level of ramp incline range	This prompt only appears on EFX units which have adjustable ramps. Settings range from 1 to 20. Refer to <i>EFX: Changing the Auto-Level Setting</i> .
Cycle	SET RESISTANCE RANGE	High	Settings range from High, Medium, and Low. Refer to <i>Cycle: Setting a Resistance Range</i> .
All †	SET CUSTOM PROGRAM 1	Random profile	Modify the program profile. Refer to <i>Creating a Custom Program</i> .
Treadmill †	SET CUSTOM PROGRAM 2	Random profile	Modify the program profile. Refer to <i>Creating a Custom Program</i> .

* This feature is available in all Precor equipment.

† This program is not available on the 946i treadmill, EFX546i, and EFX556i.

Note: If a user changes the language or unit of measure during an exercise session, the display resets to the club preferences when a user's workout ends.

Accessing Club Programming Mode and Changing the Settings

Read the *Club Programming Tips* to identify useful information about customizing your Precor equipment.

To access the available menus and change the program settings, perform the following steps:

1. At the Precor banner, press the following keys in sequence without pausing between selections:

RESET, 5, 6, 5, 1, 5, 6, 5

Note: A PAUSE/RESET key appears on some products and functions the same as the RESET key.

The club programming prompts appear sequentially and in a menu format. The following table describes which keys to use in club programming mode.

Table 3. Club Programming Mode keys

Key	Description	Function
▲ or ▼	Navigational arrow keys	Moves you through the programs and selections.
OK	OK key	Lets you choose or accept the displayed selection.
BACK	BACK key	Returns to the previous menu level without saving any changes.
RESET	RESET key or PAUSE/RESET key	Exits Club Programming Mode and returns to the Precor banner.

Note: The number keypad is disabled once you enter club programming mode.

Use the following flowchart to navigate through the menu settings on treadmills.

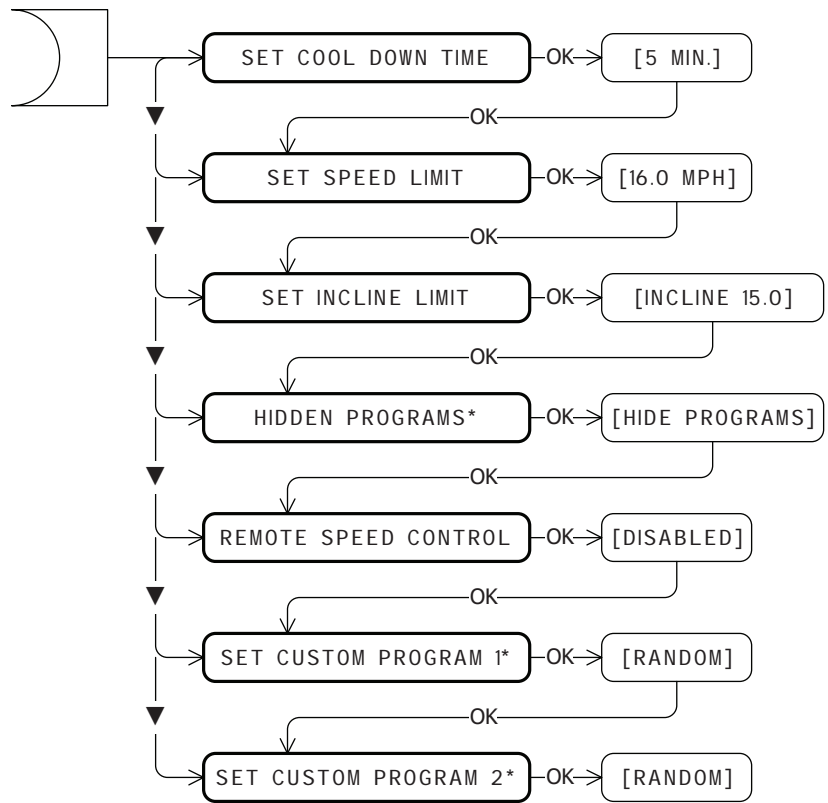
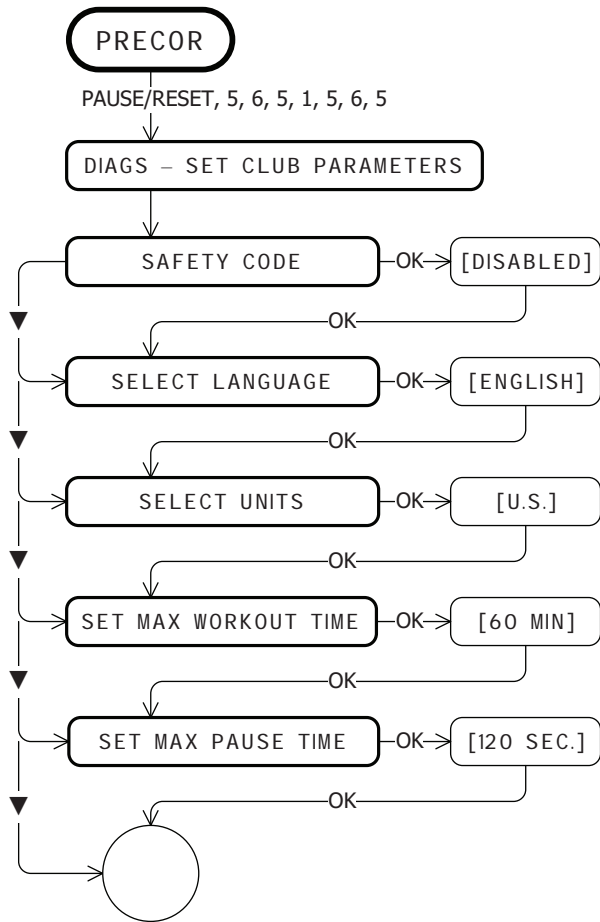

* This program is not available on the 946i treadmill.

Use the following flowchart to navigate through the menu settings on ellipticals.

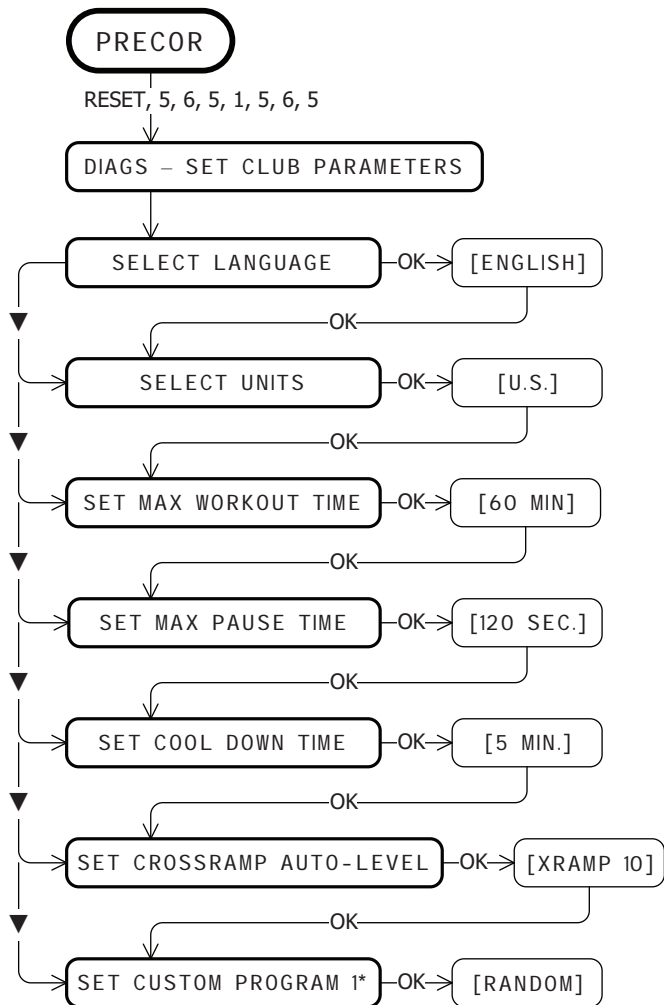

* This program is not available on the EFX546i and EFX556i.

Use the following flowchart to navigate through the menu settings on cycles.

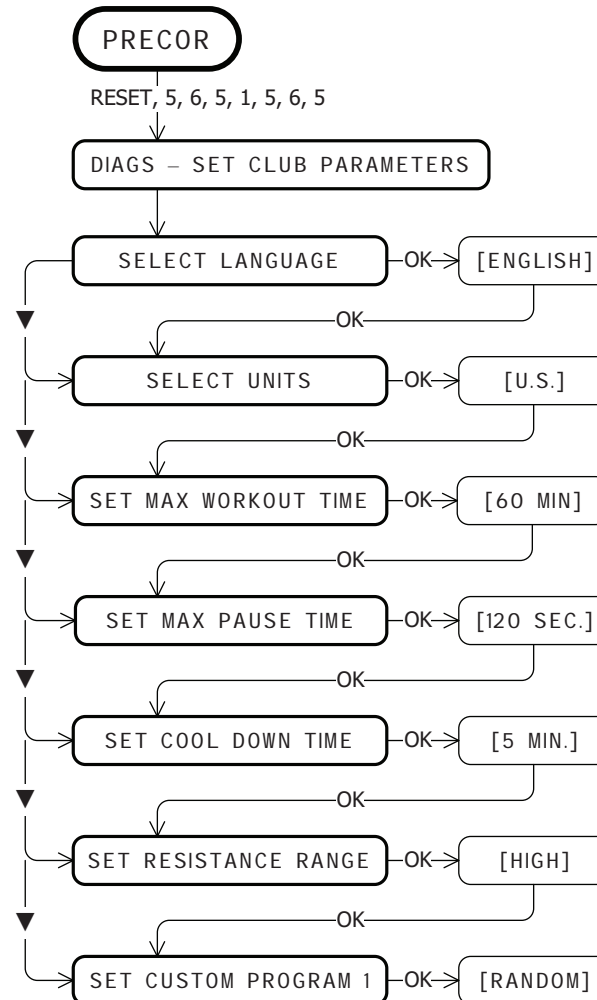

Use the following flowchart to navigate through the menu settings on climbers.

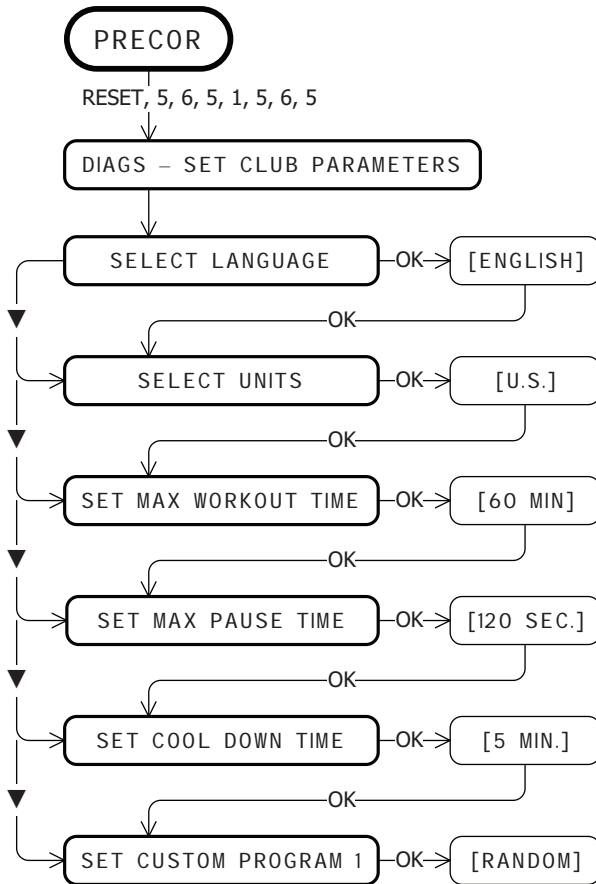

Treadmill: Selecting Safety Code Protection

When the equipment is shipped from the factory, the safety code protection feature is disabled. If you enable the safety code, your patrons will need to enter four number keys in sequence to begin their exercise session and, on the treadmill, start the running belt. If the correct keys are not pressed within two minutes, further access is denied. For more information, refer to *Entering the Safety Code*.

1. At the SAFETY CODE prompt, press OK. Use the navigational arrow keys to alternate between the two selections.

Setting	Description
ENABLED	Causes the safety code prompt to appear prior to a workout and when returning from pause mode.
DISABLED	Does not require a safety code to operate.

CAUTION: Do not assume the equipment is safe because of safety code protection. Never leave children unsupervised around the equipment.

2. When you are ready, press OK to accept the displayed setting and move to the next feature. For further options, refer to the table in *Accessing Club Programming Mode and Changing the Settings*.

Choosing a Language

The equipment can display user prompts, text, and user entries in several different languages. When the equipment is shipped from the factory, it is set to display English.

Note: Programming prompts are not affected by language selection. The prompts in this section continue to appear in English.

1. At the SELECT LANGUAGE prompt, press OK. Use the navigational arrow keys to choose a language.
2. When you are ready, press OK to accept the displayed setting and move to the next feature. For other options, refer to the table in *Accessing Club Programming Mode and Changing the Settings*.

Selecting a U.S. Standard or Metric Display

The equipment can display measurements in either Metric or U.S. Standard. The default factory setting is to display U.S. Standard. To change this setting, perform the following steps:

1. At the SELECT UNITS prompt, press OK. Use the navigational arrow keys to select a unit of measure (US or METRIC).

CAUTION: If you change the Unit of Measure display on a treadmill, be sure to check the speed setting to verify that it is correct. Refer to *Treadmill: Determining the Club Speed Limit*.

2. When you are ready, press OK to accept the displayed setting and move to the next feature. For other options, refer to the table in *Accessing Club Programming Mode and Changing the Settings*.

Setting an Exercise Session Time Limit

You can limit how long a user can exercise on the equipment. For example, if you set the time limit to 20 minutes, users can only enter a session time between 1 and 20 minutes.

Note: The automatic cool-down period is appended to the end of any time-based program, so adjust the time limit accordingly.

You can also let a user exercise indefinitely by selecting NO LIMIT. However, you will need to instruct users that once they select a program, they must press the TIME +/- key. A workout time blinks in the display. They need to use the Number Keypad to type in 240, press the up arrow key to display NO LIMIT, and then press OK.

The exercise session times available are between 1 and 240 minutes.

Note: The Military Performance Programs will not complete if the maximum exercise time limit is less than 40 minutes. Set the maximum session time above 40 minutes if you have allowed users to access these programs. Refer to *Treadmill: Accessing Performance Programs*.

1. At the SET MAX WORKOUT TIME prompt, press OK. Use the navigational arrow keys to change the displayed time limit.

Note: When you press and hold a navigational arrow key, the number increments by five, for example, 1, 5, 10, 15, 20. When you tap an arrow key, the number increments by one.

2. When you are ready, press OK to accept the displayed setting and move to the next feature. For other options, refer to the table in *Accessing Club Programming Mode and Changing the Settings*.

Setting a Pause Time Limit

You can limit how long a user can pause while exercising on the equipment by entering a time between 1 and 120 seconds (two minutes). For example, if you set a pause time limit of 60 seconds, the display automatically resets to the Precor banner if no movement is detected and no key press occurs for one minute.

Important: *The optional power adapter must be connected on self-powered equipment to establish a definitive pause time limit. If the optional power adapter is not attached and the rate of motion drops below the minimum requirements, the equipment begins its 30-second shutdown, effectively eliminating pause mode. Refer to the table in Self-Powered Features.*

1. At the SET MAX PAUSE TIME prompt, press OK. Use the navigational arrow keys to change the time limit. Choose between 1 and 120 seconds (two minutes).
2. When you are ready, press OK to accept the displayed setting and move to the next feature. For other options, refer to the table in *Accessing Club Programming Mode and Changing the Settings*.

Setting a Cool-Down Time Limit

You can limit how long a user cools down after exercising on the equipment by entering a time between 0 and 5 minutes.

Important: *It is highly recommended that you set the cool-down period at or above three minutes. It takes time for a user's heart rate to return to a resting state after vigorous exercise. An effective cool-down period also reduces the amount of lactic acid in muscle tissue.*

1. At the SET COOL DOWN TIME prompt, press OK. Use the navigational arrow keys to display the available time limits. Choose between 0 and 5 minutes. The default setting is 5 minutes.
2. When you are ready, press OK to accept the displayed setting and move to the next feature. For other options, refer to the table in *Accessing Club Programming Mode and Changing the Settings*.

Treadmill: Determining the Club Speed Limit

You can set a maximum speed for the treadmill. This limits how fast the running belt moves and, consequently, the number of speed settings that are available to the user. The speed is displayed in miles per hour (mph) or kilometers per hour (kph) depending upon the units of measure (U.S. standard or Metric) selected earlier. The speed ranges from 0.5 to 16 mph (0.8 to 25.5 kph).

Important: *If you select a number that limits the miles per hour, your change will not affect the kilometers per hour (and vice versa). The treadmill does not convert the speed entered in mph (U.S. standard) to kph (Metric). It stores separate numbers for the different units of measure. To enter both values, you must first reset the display to the appropriate unit of measure, and then change the speed limit in this program. Refer to Selecting a U.S. Standard or Metric Display.*

1. At the SET SPEED LIMIT prompt, press OK. Use the navigational arrow keys to select the desired running belt speed limit.
2. When you are ready, press OK to accept the displayed setting and move to the next feature. For other options, refer to the table in *Accessing Club Programming Mode and Changing the Settings*.

Treadmill: Setting an Incline Limit

You can set the maximum grade (percent of incline) for the treadmill. This limits the degree of incline and, consequently, the number of incline settings that are available to the user. The available range is:

Treadmill	Percent of Incline
C956i	0 to 15% grade
C966i	-3 to 15% grade

1. At the SET INCLINE LIMIT prompt, press OK. Use the navigational arrow keys to select the desired grade.
2. When you are ready, press OK to accept the displayed setting and move to the next program. For other options, refer to the table in *Accessing Club Programming Mode and Changing the Settings*.

Treadmill: Accessing Performance Programs

Note: This feature is not available on the 946i treadmill.

Several performance-based programs on the treadmill can be hidden from the user's view and, consequently, be unavailable during an exercise session. These programs are shown in the following list:

Gerkin Fitness Test, USAF PRT, NAVY PRT, ARMY PFT, USMC PFT, Federal Law Enf. PEB.

If you keep the default factory setting, the Track and 5K programs are available to the user through the PERFORMANCE key.

If you wish to change this setting, perform the following steps:

1. Press OK to review the current HIDDEN PROGRAMS selection. Use the navigational arrow keys to alternate between the two selections.

Setting	Description
SHOW PROGRAMS	Causes all the Performance Programs listed above to appear. The user can access each program through the PERFORMANCE key on the display.
HIDE PROGRAMS	Hides the Performance Programs listed above and makes them inaccessible to the user. However, the Track and 5K programs remain available and are accessed when a user presses the PERFORMANCE key.

2. When you are ready, press OK to accept the displayed setting and move to the next program. For other options, refer to the table in *Accessing Club Programming Mode and Changing the Settings*.

Treadmill: Changing Remote Control Access

Important: To affect this setting, the treadmill must be connected to a computer and you will need to be familiar with CSAFE commands.

When you enable this program, you can set a user's speed and incline through a computer software program which interfaces with the CSAFE port on the treadmill.

The default factory setting is set to DISABLED. To change this setting, perform the following steps:

1. At the REMOTE SPEED CONTROL prompt, press OK. Use the navigational arrow keys to alternate between the two selections.

Setting	Description
ENABLED	Lets you set the speed and incline for individual users and their selected program using CSAFE commands through a computer connection.
DISABLED	Disconnects remote access so you cannot use the remote capabilities of a CSAFE connection. You would also use this setting when the treadmill is not connected to a computer.

2. When you are ready, press OK to accept the displayed setting and move to the next program. For other options, refer to the table in *Accessing Club Programming Mode and Changing the Settings*.

EFX: Changing the Auto-Level Setting

You can set a specific ramp incline so that the EFX automatically returns to it at the end of a workout session. Whatever incline you set, the EFX ramp returns to the setting if a user continues pedaling, once the program session has ended, and presses RESET to return to the Precor banner.

Note: This setting is available on equipment with adjustable ramps.

Important: *If you use this feature, connecting the optional power adapter is recommended. Instruct users about the auto-leveling feature and ask that they hold onto a stationary handrail with one hand while the equipment automatically moves to the set incline.*

1. At the SET CROSSRAMP AUTO-LEVEL prompt, press OK.
2. XRAMP n appears, where n is the ramp incline setting. Some displays only show a number without prefacing it with XRAMP. Use the navigational arrow keys to select the desired ramp incline setting from 1 to 20.
3. When you are ready, press OK to accept the displayed setting and move to the next feature. For other options, refer to the table in *Accessing Club Programming Mode and Changing the Settings*.

Cycle: Setting a Resistance Range

You can set a low, medium or high range of resistance on the recumbent or upright cycles. Within each setting, 25 levels of resistance are available, but the chosen setting affects the overall resistance range.

Physical therapy conditioning is an example where you might use this programming feature. If a user has an injury that needs low levels of resistance, you might set the resistance range to low to make sure that the user does not induce further injury by exceeding your recommended levels of resistance.

The following table provides short descriptions of each group.

Table 4. Resistance range settings on cycles

Setting	Description
HI or HIGH	Provides the full range of resistance available. If an upright cycle user chooses the high-end resistance levels, the cycle provides enough resistance to simulate sprinting or hill climbing for users wishing to stand on the upright cycle. It also provides enough resistance for elite riders that are capable of spinning at high speed with high resistance.
MED or MEDIUM	Provides approximately two thirds of the resistance that is available within the high group setting. Club owners may want to select the medium range for recumbent cycles. Since users cannot stand on recumbent cycles, less resistance is needed by the average (non-elite) user. A medium range may provide more comfort. It also allows users to make easier resistance changes in the preset programs.
LO or LOW	Provides approximately one third of the resistance that is available within the high group setting. The low range may be appropriate in special situations where poorly conditioned users are anticipated. The low range is not recommended for the club environment.

1. At the SET RESISTANCE RANGE prompt, press OK. Use the navigational arrow keys, to choose LOW, MEDIUM or HIGH (LO, MED, or HI on some equipment).
2. When you are ready, press OK to accept the displayed setting and move to the next feature. For other options, refer to the table in *Accessing Club Programming Mode and Changing the Settings*.

Creating a Custom Program

Note: This feature is not available on the 946i treadmill, EFX546i and EFX556i.

When you design a custom program, you are preprogramming the program profile.

1. At the SET CUSTOM PROGRAM prompt, press OK. The program profile appears in the display and a blinking column indicates your starting point.

Note: Two custom programs are available on the treadmill. All other Precor products contain one custom program. The prompt indicates which one you have accessed. For example, SET CUSTOM PROGRAM 1 scrolls across the display to indicate you are selecting the first custom program. If you have a treadmill and wish to select the second custom program, press the down arrow key on the navigational keypad, before pressing OK in step 6.

2. When the Custom Program profile appears, press the down arrow key on the navigational keypad, to select the column you wish to change.
3. To change the height of the column, refer to the following table.

Table 5. Custom Program keys

Equipment	Key	Description
Treadmill	INCLINE keys	Changes the column height and affects the Custom Program incline.
EFX	CROSSRAMP keys	Changes the column height and affects the Custom Program ramp incline.
Cycle	RESISTANCE keys	Changes the column height and affects the Custom Program pedal resistance.
Climber	RESISTANCE keys	Changes the height of the column and affects the Custom Program step resistance.

4. When the column height is set, press the down arrow key on the navigational keypad, to move to the next column. You can press the up arrow key to move back and change earlier columns as needed.
5. Continue adjusting the profile for each column.
6. When you are ready, press OK to save the program profile and return to the Precor banner.

Note: If you prefer to exit the program without saving changes to the custom profile, press BACK.

Informational Displays

The equipment provides information about its use (odometer and hour meter), as well as software versions and part numbers, serial number, usage log, and error log. In general, you would only access this information if directed to do so by Precor Customer Support.

To navigate through the informational displays, use the following flowchart. Descriptions for these displays are shown in the following table.

Note: If your product has a PAUSE/RESET key, use it in place of the RESET key called out in the flowchart.

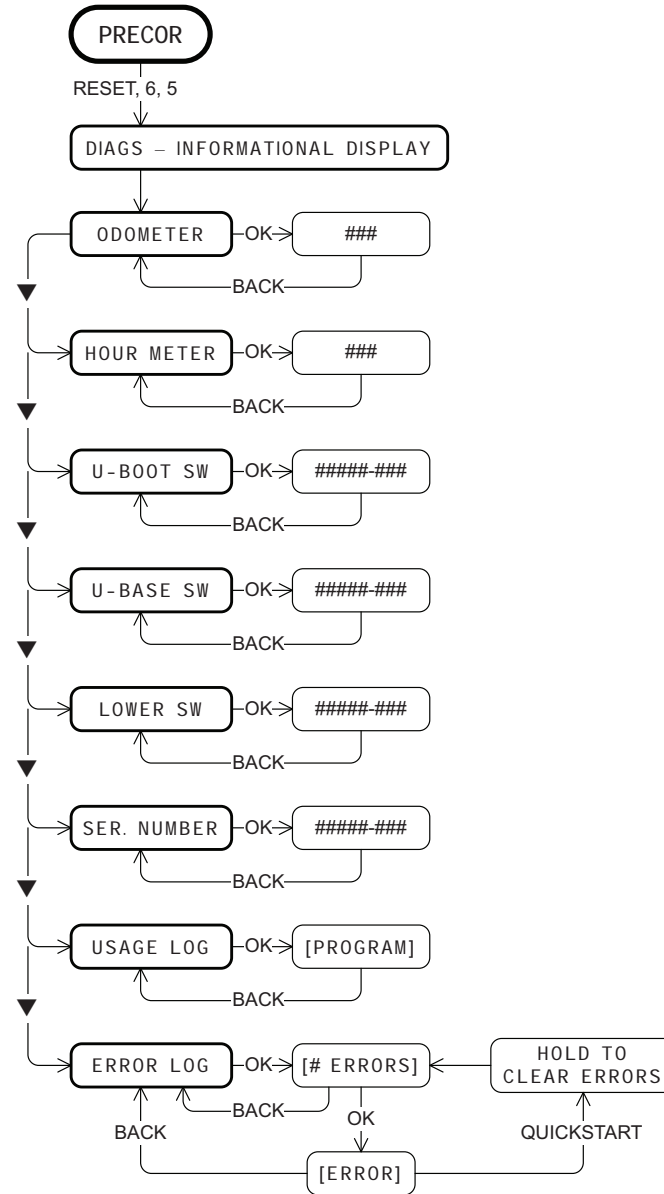

Table 6. Informational Displays

Product	Display	Description
All	ODOMETER	The odometer value correlates to the type of Precor product and the standard of units, U.S. or Metric, selected in the club programs. Treadmill shows the number of cumulative miles or kilometers logged to date. EFX or AMT shows the number of total strides logged to date. Cycle shows the number of total revolutions logged to date. Climber indicates the number of floors climbed.
All	HOUR METER	The number of hours that the equipment has been in use. The equipment tracks the elapsed minutes, but the value that appears is truncated to the nearest full hour.
All	U - BOOT SW	Upper board application software part number and version. Note: Some displays show UPPER BOOT SW PART NUMBER.
All	U - BASE SW	Upper base application software version. Note: Some displays show UPPER BASE SW PART NUMBER.
All	LOWER SW	Lower application software version. Note: Some displays show LOWER BASE SW PART NUMBER.
534i, 532i, AMT	METRICS BOARD SW PART NUMBER	Metrics board software part number and version.
AMT	STRIDE DIAL SW PART NUMBER	Stride dial software part number.
All	SER. NUMBER	The serial number is helpful when you contact Customer Support. You can also find the serial number located on a label on the front hood (treadmills) or optional power receptacle (self-powered equipment) if one does not appear in the display. Note: Some displays show SERIAL NUMBER.
All	USAGE LOG	The software logs the number of times each program has been used and displays the associated cumulative minutes. The usage log is helpful in determining user preferences in program selection.
All	ERROR LOG	The error log displays any error codes that may have been detected by the software. Copy the error code information to paper so you can provide it to Customer Support, if needed. Be sure to copy it exactly as shown. Refer to <i>Error Log</i> .

Error Log

Quick access to the informational display is available if error messages have appeared on the display and have been recorded in the error log. This feature is usually reserved for service personnel. At the Precor banner, press and hold RESET for 4 seconds. If `DIAGS - INFORMATION DISPLAY` or `ERROR LOG` appears, press OK.

If no errors are logged, `STOP KEY` or `STUCK KEY` appears. When you release the key, the Precor banner returns.

Note: On treadmills, the red STOP button can be used instead of the PAUSE/RESET key.

Erasing the Error Log

When you no longer need the error log information, you may erase all entries in the error log by pressing the QUICKSTART key while any error description is scrolling across the display. Continue to maintain light pressure on the key until the message, `HOLD TO CLEAR ERRORS`, scrolls off the display. When the key is released, `NO ERRORS` appears on the display, which indicates the error log has been deleted.

Important: *You cannot retrieve the error log once you have deleted it. You may want to resolve any issues you are experiencing with the equipment before erasing the error log.*

When you are ready, press RESET to return to the Precor banner.

User ID Entry with CSAFE Equipment

The equipment is fully compatible with CSAFE protocols. When the equipment is connected to a CSAFE master device, the user is prompted to press ENTER and begin an identification process.

The user ID is displayed as five zeros and indicates the starting point. The following table describes key functions while in CSAFE mode.

Table 7. CSAFE access keys

Keypad	Description
Number keypad	Use the number keys to enter a user ID. The number that is pressed appears on the right. As the user continues, the numbers fill in the display from right to left. When all five numbers are in place, the user must press ENTER or OK to submit the user ID.
CLEAR or BACK	Erases individual numbers in the user ID from right to left.
ENTER or OK	Submits the user ID. Note: User ID entry is bypassed when the user enters five zeros. No workout statistics are recorded.
RESET or PAUSE/RESET	Resets the display to the banner.

A message appears on the display and indicates when the user ID is accepted by the CSAFE master device. Once program selection is complete, the user can begin exercising.

To review information about CSAFE specifications, visit the web site at: www.fitlinxx.com/csaf

If you have questions or need technical support, refer to *Obtaining Service*.

Maintenance

It is important to perform the minor maintenance tasks described below. Failure to maintain the equipment as described in this section could void the Precor Limited Warranty.

DANGER To reduce the risk of electrical shock, always unplug the equipment from its power source (an optional power adapter in the case of self-powered equipment) before cleaning it or performing any maintenance tasks.

Daily Inspection

Look and listen for slipping belts, loose fasteners, unusual noises, worn or frayed power cords, and any other indications that the equipment may be in need of service. If you notice any of these, obtain service.

On treadmills, check for worn, frayed or missing safety lanyards. Replace missing or worn safety lanyards immediately. Make sure users attach the safety clip to their clothing before exercising on the treadmill.

Important: If you determine that the equipment needs service, disconnect any power connections and move the equipment away from the exercising area. Place an **OUT OF SERVICE** sign on it and make sure all patrons and users know that they must not use the equipment.

To order parts or to contact a Precor authorized service provider in your area, refer to *Obtaining Service*.

Daily Cleaning

Precor recommends the equipment be cleaned before and after each exercise session. Use mild soap and water to dampen a clean, soft cloth and wipe all exposed surfaces. This helps remove dust and dirt.

CAUTION: Do not use any acidic cleaners. Doing so will weaken the paint or powder coatings and void the Precor Limited Warranty. Never pour water or spray liquids on any part of the equipment. Allow the equipment to dry completely before using.

Frequently vacuum the floor underneath the equipment to prevent the accumulation of dust and dirt, which can affect the smooth operation of the equipment. Use a soft nylon scrub brush to clean the running belt on treadmills or the grooves on equipment with foot pedals.

CAUTION: On treadmills, as you clean the hood or side rails, be aware of the handrail extensions so you do not inadvertently hit your head or injure yourself.

EFX: Cleaning the Ramp

Whenever the ramp becomes soiled, clean the exposed surfaces of the ramp and roller wheels by taking the following steps.

Note: If your equipment has a ramp cover, remove it before performing the following steps. Refer to the *EFX Assembly Guide*.

1. Moisten a clean, soft cloth in a mild solution of soap and water.
2. Position one foot pedal at the top of the ramp (the other will automatically be positioned at the bottom).
3. Clean the exposed portions of the ramp.
4. Gently lift the roller wheels. Rotate each wheel while wiping it with the clean, soft cloth.
5. Switch the foot pedal position and finish cleaning the ramp.

Storing the Chest Strap

If you purchased the optional heart rate chest strap, store it in a place where it remains free of dust and dirt (for example, in a closet or drawer). Be sure to protect the chest strap from extremes in temperature. Do not store it in a place that may be exposed to temperatures below 32° F (0° C).

To clean the chest strap, use a sponge or soft cloth dampened in mild soap and water. Dry the surface thoroughly with a clean towel.

Treadmill: Checking the Alignment of the Running Belt

Proper belt alignment allows the belt to remain centered and ensures smooth operation. Realigning the belt takes a few simple adjustments. If you are unsure about this procedure, call Precor Customer Support. Refer to *Obtaining Service*.

CAUTION: Special care must be taken when aligning the running belt. Turn Off the treadmill while adjusting or working near the rear roller. Remove any loose clothing and tie back your hair. Be very careful to keep your fingers and any other object clear of the belt and rollers, especially in front of the roller and behind the deck. The treadmill will not stop immediately if an object becomes caught in the belt or rollers.

1. Make sure that the running surface is level. To operate correctly, the treadmill needs to be as level as possible. If needed, the rear feet can be adjusted to level the treadmill (refer to the *Assembly Guide*).
2. Turn the equipment On.
3. Stand beside the treadmill and press QUICKSTART.
4. If needed, enter the safety code by pressing the number keys in sequence: 1, 2, 3, 4.

The running belt starts automatically after a 3-second countdown appears on the display.

5. Press the SPEED up key until the display shows a speed of 3 mph (5 kph).

CAUTION: If you hear any chafing or the running belt appears to be getting damaged, stop the running belt immediately by pressing the red STOP button. Contact Precor Customer Support.

6. Walk around to the rear of the equipment and observe the belt for a few minutes. The belt should run centered along the running bed. If the belt drifts off center, you must make adjustments. Refer to *Treadmill: Adjusting the Running Belt*.

Important: Failure to align the belt may cause the belt to tear or fray, which is not covered by the Precor Limited Warranty.

7. To stop the running belt, press the red STOP button.
8. Turn the treadmill Off.

Treadmill: Adjusting the Running Belt

If you are unsure about adjusting the running belt, call Precor Customer Support (refer to *Obtaining Service*).

CAUTION: For your safety, use the power switch to turn Off the treadmill before making any adjustments. Do not adjust the running belt when someone is standing on the equipment.

1. Locate the right belt adjustment bolt in the rear end cap of the treadmill as shown in the following figure.

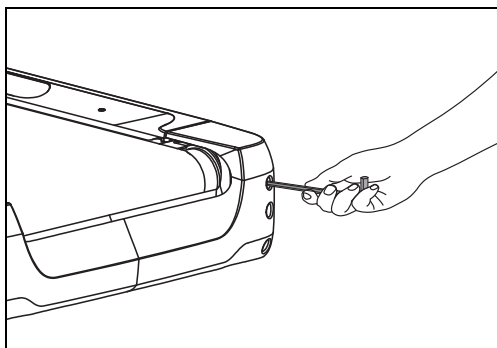

Figure 4: Location of the adjustment bolt

To determine left and right, stand at the rear of the treadmill and face the display. Make all belt adjustments on the right rear corner bolt using the hex key provided.

- If the belt is off center to the LEFT, turn the adjusting bolt $\frac{1}{4}$ turn *counterclockwise*, which moves the running belt to the right.
- If the belt tracks off center to the RIGHT, turn the bolt $\frac{1}{4}$ turn *clockwise*; this moves the belt to the left.

Important: Do not turn the adjusting bolt more than $\frac{1}{4}$ turn at a time. Overtightening the bolt can damage the treadmill.

2. Recheck the alignment of the running belt by repeating the steps found in *Treadmill: Checking the Alignment of the Running Belt*.

Upright Cycle: Adjusting the Seat Tilt

To adjust the seat tilt on an upright cycle, take the following steps.

1. Use a $1\frac{1}{16}$ -inch (17 mm) box-end wrench or crescent wrench to loosen the nut beneath the seat as shown in the following figure.

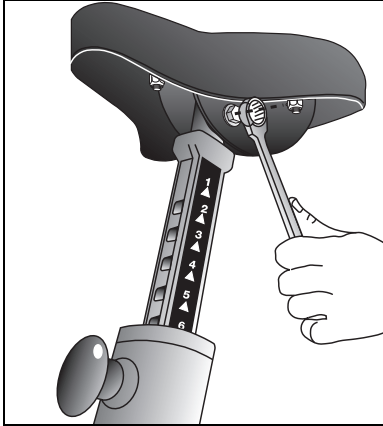

Figure 5: Loosen nut to adjust seat tilt

2. Adjust the seat tilt (forward or backward) as shown in the following figure.

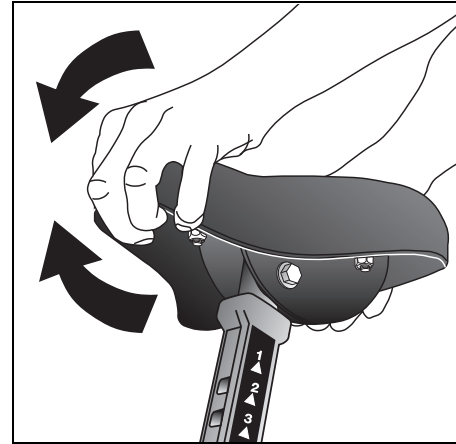

Figure 6: Tilt the seat forward or backward

3. Wrench tighten the nut
4. Apply pressure to the seat and make sure that it does not move. Readjust and retighten the nut, if needed.

Recumbent Cycle: Realigning the Seat

If the seat rocks side-to-side, you need to realign the center wheel underneath the seat. Adjustment screws are located on the left side of the seat rail.

To remove seat wobble (side-to-side movement), take the following steps.

1. Obtain a $\frac{3}{16}$ -inch and $\frac{5}{16}$ -inch hex key.
2. Use the $\frac{3}{16}$ -inch hex key to loosen the two adjustment screws as shown in the following figure.

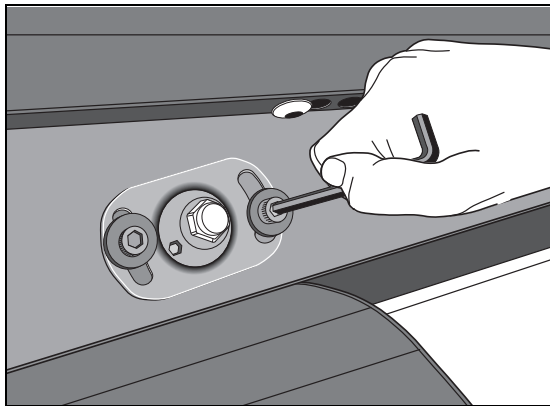

Figure 7: Loosen the two adjustment screws

3. Use the $\frac{5}{16}$ -inch hex key to turn the wheel lock adjustment key clockwise $\frac{1}{4}$ turn as shown in the following figure. This process realigns the center wheel inside the top rail. Leave the $\frac{5}{16}$ -inch hex key in place while you tighten the adjustment screws with the $\frac{3}{16}$ -inch hex key.

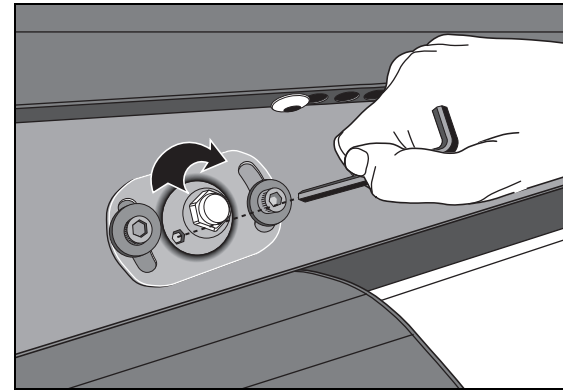

Figure 8: Wheel lock adjustment

4. Remove the hex keys and check that the seat no longer rocks side-to-side. If the rocking movement continues, you need to repeat steps 2 and 3.

Moving the Equipment

It is important, if you plan to move the equipment, that you obtain adult help and use proper lifting techniques. The equipment is very heavy. Take advantage of the roller wheels on the equipment when moving it to a new location.

Important: *The plastic end cap, on the treadmill, is specifically designed for lifting. To avoid injury to yourself or damage to the equipment, ask for help in placing the treadmill where you plan to use it. Place a hand under each end of the end cap and, using proper lifting techniques, lift the rear of the treadmill so that it rolls on its front wheels.*

Long-Term Storage

When the equipment is not in use for any length of time, make sure it is turned Off (treadmill only) and the power cord or optional power adapter (self-powered equipment) is unplugged from its power source and is positioned so that it will not become damaged or interfere with people or other equipment.

Notes:

Precor Commercial Equipment Limited Warranty

PLEASE READ THESE WARRANTY TERMS AND CONDITIONS CAREFULLY BEFORE USING YOUR PRECOR INCORPORATED PRODUCT. BY USING THE EQUIPMENT, YOU ARE CONSENTING TO BE BOUND BY THE FOLLOWING WARRANTY TERMS AND CONDITIONS.

Limited Warranty.

Precor Incorporated warrants all new Precor products to be free from defects in materials and manufacture for the warranty periods set forth below. The warranty periods commence on the invoice date of the original purchase. This warranty applies only against defects discovered within the warranty period and extends only to the original purchaser of the product. Parts repaired or replaced under the terms of this warranty will be warranted for the remainder of the original warranty period only. To claim under this warranty, the buyer must notify Precor or your authorized Precor dealer within 30 days after the date of discovery of any nonconformity and make the affected product available for inspection by Precor or its service representative. Precor's obligations under this warranty are limited as set forth below.

Warranty Periods and Coverage.

Commercial Cardiovascular Products, also known as C-Series Products, (excluding StretchTrainer, Strength Products).

- Seven years frame, five years display face assembly, three years motor controller, one year durable wear parts, two years parts, one year labor.
- For treadmills, five years drive motor.
- For self-powered ellipticals and bikes, one year battery.
- For InSite, one year parts and labor.
- Labor coverage for options as defined below.

StretchTrainer

Five years frame, two years parts, 90 days upholstery, no labor.

Strength Products (S3.45 and S3.25 only)

Ten years frame; three years bearings, guide rods, cams, pulleys; one year belts, cables, hand grips, miscellaneous parts; 90 days upholstery; no labor.

Options / Accessories / Battery-powered or Self-Operated Devices

Many options or accessories have components that are connected internally or mounted inside the electronic console. The following guidelines determine the warranty for these components. If the internal components are installed by the factory or by an authorized dealer as part of the original sale and delivery, they have a warranty that is identical to the warranty of the equipment in which they are connected or mounted. If the internal components are not installed by the factory or by an authorized dealer as part of the original sale and delivery, they have a 90 days parts and labor limited warranty. All components that are not internally connected have a 90 days parts only limited warranty. Satisfactory proof of purchase is required in all cases.

Conditions and Restrictions.

This warranty is valid only in accordance with the conditions set forth below:

1. The warranty applies to the Precor product only while
 - a. it remains in the possession of the original purchaser and proof of purchase is demonstrated,
 - b. it has not been subjected to accident, misuse, abuse, improper service, or non-Precor modification.
 - c. claims are made within the warranty period.
2. Certain products are warranted for standard commercial use only (defined as use in non-fee paying clubs or facilities and less than 6 hours daily use. Unapproved use voids the warranty. Current standard commercial products include C936i, C932i, EFX524i, EFX534i.).
3. This warranty does not cover damage or equipment failure caused by electrical wiring not in compliance with electrical codes or Precor owner's manual specifications, or failure to provide reasonable and necessary maintenance as outlined in the owner's manual.
4. Except in Canada, Precor does not pay labor outside the United States.
5. Warranties outside the United States and Canada may vary. Please contact your local Dealer for details.

This Limited Warranty shall not apply to:

1. Software (PROM) version upgrades.
2. Normal wear and tear, consumables and cosmetic items, including, but not limited to the following: grips, seats, and labels.
3. Repairs performed on Precor equipment missing a serial number or with a serial tag that has been altered or defaced.
4. Service calls to correct installation of the equipment or instruct owners on how to use the equipment.
5. Pickup and delivery involved with repairs.
6. Any labor costs incurred beyond the applicable labor warranty period.

Disclaimer and Release.

The warranties provided herein are the exclusive warranties given by Precor and supersede any prior, contrary or additional representations, whether oral or written. ANY IMPLIED WARRANTIES, INCLUDING THE WARRANTY OF MERCHANTABILITY OR FITNESS FOR A PARTICULAR PURPOSE THAT APPLY TO ANY PARTS DESCRIBED ABOVE ARE LIMITED IN DURATION TO THE PERIODS OF EXPRESS WARRANTIES GIVEN ABOVE FOR THOSE SAME PARTS. PRECOR HEREBY DISCLAIMS AND EXCLUDES THOSE WARRANTIES THEREAFTER. Some States do not allow limitations on how long an implied warranty lasts, so the above limitation may not apply to you. PRECOR ALSO HEREBY DISCLAIMS AND EXCLUDES ALL OTHER OBLIGATIONS OR LIABILITIES, EXPRESS OR IMPLIED, ARISING BY LAW OR OTHERWISE, WITH RESPECT TO ANY NONCONFORMANCE OR DEFECT IN ANY PRODUCT, INCLUDING BUT NOT LIMITED TO: (A) ANY OBLIGATION, LIABILITY, RIGHT, CLAIM OR REMEDY IN TORT, WHETHER OR NOT ARISING FROM THE NEGLIGENCE OF PRECOR OR ITS SUPPLIERS (WHETHER ACTIVE, PASSIVE OR IMPUTED); AND (B) ANY OBLIGATION, LIABILITY, RIGHT, CLAIM OR REMEDY FOR LOSS OF OR DAMAGE TO ANY EQUIPMENT. This disclaimer and release shall apply even if the express warranty set forth above fails of its essential purpose.

Exclusive Remedies.

For any product described above that fails to conform to its warranty, Precor will provide, at their option, one of the following: (1) repair; (2) replacement; or (3) refund of the purchase price. Precor Limited Warranty service may be obtained by contacting the authorized dealer from whom you purchased the item. Precor compensates Servicicers for warranty trips within their normal service area to repair commercial equipment at the customer's location. You may be charged a trip charge outside the service area. THESE SHALL BE THE SOLE AND EXCLUSIVE REMEDIES OF THE BUYER FOR ANY BREACH OF WARRANTY.

EXCLUSION OF CONSEQUENTIAL AND INCIDENTAL DAMAGES.

PRECOR AND/OR ITS SUPPLIERS SHALL HAVE NO OBLIGATION OR LIABILITY, WHETHER ARISING IN CONTRACT (INCLUDING WARRANTY), TORT (INCLUDING ACTIVE, PASSIVE, OR IMPUTED NEGLIGENCE AND STRICT LIABILITY), OR OTHERWISE, FOR DAMAGE TO THE EQUIPMENT, PROPERTY DAMAGE, LOSS OF USE, REVENUE OR PROFIT, COST OF CAPITAL, COST OF SUBSTITUTE EQUIPMENT, ADDITIONAL COSTS INCURRED BY BUYER (BY WAY OF CORRECTION OR OTHERWISE) OR ANY OTHER INCIDENTAL, SPECIAL, INDIRECT, OR CONSEQUENTIAL DAMAGES, WHETHER RESULTING FROM NONDELIVERY OR FROM THE USE, MISUSE OR INABILITY TO USE THE PRODUCT. This exclusion applies even if the above warranty fails of its essential purposes and regardless of whether such damages are sought for breach of warranty, breach of contract, negligence, or strict liability in tort or under any other legal theory. Some states do not allow the exclusion or limitation of incidental or consequential damages, so the above limitation may not apply to you.

This warranty gives you specific legal rights, and you may also have other rights, which vary from state to state.

Complete this portion and keep for your records.

Purchased From: _____
(Dealer or store name)

Phone Number: _____
(Dealer or store telephone number)

Product/Model: : _____
(For example: EFX534i or C966i)

Serial Number: : _____
(The serial number is found on the shipping container.)

Effective 27 March, 2006
P/N 36286-112

Thank You and Welcome to Precor



We are confident that you will be pleased with your purchase and that your new Precor equipment will help satisfy your customers' fitness needs, while helping you meet your business goals.

To allow us to serve you better, please take a few moments to complete and return your warranty registration.

YOU MAY ALSO REGISTER ONLINE AT

www.precor.com/warranty

If you have questions or need additional information, contact your local dealer or call Precor Commercial Products Customer Support at 888-665-4404.

Fold along dotted line and tape closed before mailing.

COMM.

Woodinville, WA 98072-4002

PO Box 7202

20031 142nd Avenue NE

Precor Incorporated



PLACE
STAMP
HERE

TELL US ABOUT YOUR NEW PRECOR PRODUCTS

Date of Purchase:

Month Day Year

Purchased from (Dealer name):

Product Serial Number(s):

Please indicate the type and number of products purchased:

#: _____ Elliptical Fitness CrossTrainer (EFX®)
 #: _____ Treadmill #: _____ Stair Climber
 #: _____ Cycle #: _____ Strength Station
 #: _____ StretchTrainer™

The serial number is located on the shipping box and on the product.

Add additional sheets of paper or register online at www.precor.com/warranty

TELL US ABOUT YOUR FACILITY

Name of Facility _____

Mr. M/s. Ms.
 Contact Person — First Name _____ Last Name _____

Facility Address _____ Apt./Suite _____

City _____ State _____ Zip Code _____

Area Code _____ Facility Telephone Number _____

Your Business Email Address _____

How many members do you have?

Less than 100 100 – 500 500 – 1000 1000 – 2000 2001 +

What percentage of floor space do you allocate for cardio equipment?

0% to 20% 20% to 40% 40% to 60% 60% to 80% 80% to 100%

What type of equipment makes up your cardio offering (check all that apply)?

Treadmills Ellipticals Cycles Stair Climbers Rowing Machines Other _____

What other brands of cardio equipment do you currently offer (check all that apply):

Life Fitness True Cybex StarTrac Other _____

What other Precor equipment do you currently offer (check all that apply):

EFX Cycle StretchTrainer™ Treadmill Stair Climber Strength Machine Other _____

TELL US ABOUT YOUR PURCHASE

Which best describes this purchase (check all that apply):

First Precor product Replaces a Precor product of the same type
 Replaces same type of product – different brand Enhancement to equipment already owned

How did you FIRST become aware of this product (choose only one):

Authorized Precor dealer Precor sales representative Trade show/conference
 Internet News report or product review Club/fitness magazine advertisement
 Trade/consumer magazine article Other _____

What factors MOST influenced your decision to purchase this product (choose up to three):

Precor reputation Prior product experience Design/appearance Value for the price
 Special product features Warranty Service Rebate or sale price

Please detach and mail in the warranty registration within ten days of purchase.



Precor Incorporated
20031 142nd Ave NE
P.O. Box 7202
Woodinville, WA USA 98072-4002
1-800-347-4404

Precor, C, CrossRamp, EFX, M, Move Beyond, and SmartRate are registered trademarks of Precor Incorporated.
Crosstrainer, QuickStart, and StretchTrainer are trademarks of Precor Incorporated.
Copyright 2008 Precor Incorporated.
Specifications subject to change without notice.
www.precor.com

NOTICE:

Precor is widely recognized for its innovative, award winning designs of exercise equipment. Precor aggressively seeks U.S. and foreign patents for both the mechanical construction and the visual aspects of its product design. Any party contemplating the use of Precor's product designs is hereby forewarned that Precor considers the unauthorized appropriation of its proprietary rights to be a very serious matter. Precor will vigorously pursue all unauthorized appropriation of its proprietary rights.



POM C-L 48995-107, en
Warranty # 36286-112, en
Registration Card# 45622-101, en
03 March 2008

User's Reference Manual

946i

956i

966i

Commercial Treadmills



PRECOR[®] USA
move beyond[®]

Important Safety Instructions

When using Precor equipment, always take basic precautions, including the following:

- Read all instructions before using the equipment. These instructions are written for your safety and to protect the equipment.
- Other sections in this manual provide more details of safety features. Be sure to read these sections and observe all safety notices.
- Take time to discuss proper safety and exercise equipment etiquette with the fitness facility manager.
- Before beginning any fitness program, see your physician for a complete physical examination.

Il est conseillé de subir un examen médical complet avant d'entreprendre tout programme d'exercice. Si vous avez des étourdissements ou des faiblesses, arrêtez les exercices immédiatement.

- Do not overexert yourself or work to exhaustion. If you feel any pain or abnormal symptoms, stop your workout immediately and consult your physician.
- Do not allow children or people unfamiliar with its operation on or near the equipment. Do not leave children unsupervised around the equipment.
- Wear proper exercise clothing and shoes for your workout and avoid loose clothing. Do not wear shoes with heels or leather soles. Check the soles of your shoes and remove any dirt and embedded stones. Tie long hair back.

- For safety, hold onto a stationary handrail or handlebar while using the equipment.
- Keep your body and head facing forward. Never attempt to turn around on the equipment.
- Do not rock the equipment. Do not stand on the handrail(s), display console, or hood.
- Use care when getting on or off the treadmill. Always grasp the handrail when stepping on the running belt and keep the initial speed at or below 1 mile per hour (mph) or 1 kilometer per hour (kph). Never step off the treadmill while the running belt is moving.
- Before the running belt begins moving (before your workout), and after it stops (at the end of your workout), straddle the running belt by placing your feet firmly on the right and left trim strips.
- The safety clip must be attached at waist level before your workout. A lanyard connects the safety clip to the red STOP button on the display console. If you encounter difficulties, a strong tug on the lanyard stops the running belt.

Safety Code

The fitness facility you are using has the option to enable a safety code. The code involves entering four number keys in sequence. If the correct keys are not pressed within two minutes, further access is denied and the running belt will not move. For more information, refer to *Entering the Safety Code*.

Obtaining Service

The fitness facility manager can help you with most questions regarding the equipment. For additional information about product operation or exercise routines, refer to the Precor web site at www.precor.com.

Table of Contents

Important Safety Instructions	1
Safety Code.....	2
Obtaining Service	2
Treadmill Safety Features	5
Using the Safety Clip.....	5
Entering the Safety Code.....	6
Using the Stationary Handrails.....	6
Turning the Treadmill On and Off.....	6
Heart Rate Features	7
Important Use and Safety Information.....	7
Wearing a Chest Strap.....	9
Using the Touch-Sensitive Grips.....	10
Using SmartRate	10
Exercise to Your Target Heart Rate	12
Heart Rate Analysis	12
Troubleshooting Heart Rate.....	13
Display Console	14
More Information about the Upper Display	16
More Information about the Center Display	18
More Information about the Lower Display	18
Keypads.....	20

Workout Options	25
Choosing QUICKSTART	26
Selecting a Program.....	27
Storing Workout Statistics	28
Setting Display Preferences Before Exercising	29
Cooling Down After a Workout	30
Pausing During a Workout or the Cool-Down Period.....	30
Ending a Workout.....	31
Programs	32
Choosing a Program	32
Program Tips.....	32
Manual Program	33
Interval Program	34
Random Program.....	35
Cross Country Program	35
966i/956i Gluteal Programs	36
966i/956i Custom Programs	36
Heart Rate Programs	36
Weight Loss Programs.....	39
Track Program	40
5K Program	40
Fitness Tests.....	41

Exercise Session	43
Changing Programs in Mid-session.....	43
Changing the Workout Time	44
Addressing Your Weight and Age	44
Adjusting Program Goals	45
Adjusting Your Target Heart Rate	46
Changing Your Workout Display Options.....	46
Changing the Units of Measure	48
Selecting a Language	48

Treadmill Safety Features

The treadmill is equipped with certain items that, when used properly, help sustain an enjoyable workout. These items include:

- Safety clip
- Safety code
- Handrails
- Power switch

Important: Before exercising, review the Important Safety Instructions found at the beginning of this manual.

Using the Safety Clip

Attach the safety clip to your clothing before each workout. A tug on the lanyard trips the safety switch inside the display console and stops the running belt.

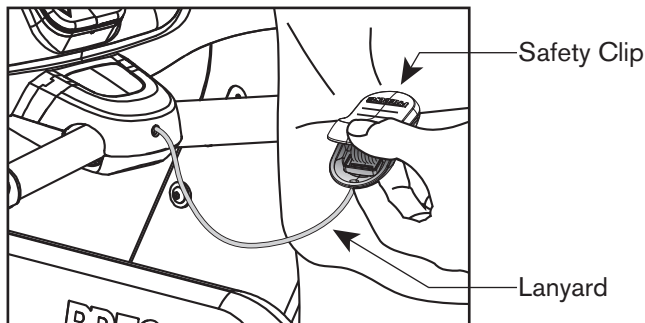

Figure 1: Attaching the safety clip

If the safety switch trips while you are exercising, the running belt stops and the treadmill assumes you are pausing your workout. To resume exercising, take the following steps:

1. Reattach the safety clip to your clothing.
2. Straddle the running belt.
3. Press QUICKSTART.

Important: Hold onto the handrail when you step onto the running belt and while you adjust the speed.

4. Enter the safety code (if necessary).

Note: The facility can set a limit on the amount of time you can pause during a workout. Check with the manager to find out about the pause time limit. If you exceed the time limit, the display returns to the Precor banner.

Entering the Safety Code

The fitness facility has the option to require a safety code. If the safety code prompt appears, press the following number keys sequence:

1,2,3,4.

An asterisk appears on the display with each key press. Hold onto the handrail and straddle the running belt. The running belt starts moving after a 3-second countdown.

Note: If the correct keys are not pressed within two minutes or you press more than four numbers, the Precor banner appears on the display and the running belt does not move.

Using the Stationary Handrails

To maintain your balance, always grasp a stationary handrail when you step on or off the equipment and when you use the keypads.

To learn more about the touch-sensitive grips, refer to *Heart Rate Features*.

Turning the Treadmill On and Off

To turn the treadmill On and Off, use the power switch located beneath the hood, near the power cord receptacle. Refer to the following figure.

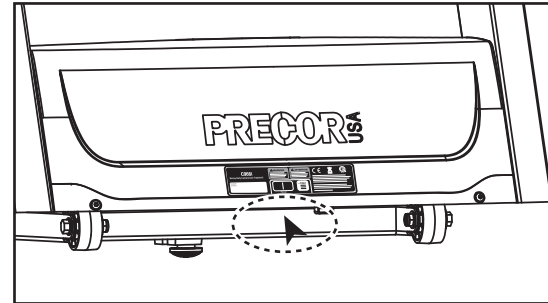
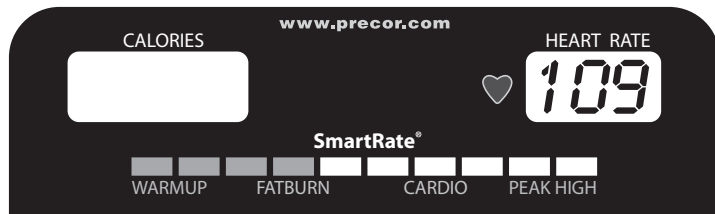

Figure 2: Power switch location

Heart Rate Features



Heart rate and SmartRate® features are available when you wear the chest strap or grasp both touch-sensitive grips. When a heartbeat is detected, the HEART RATE display shows your heart rate and, if your age has been entered, the SmartRate LED blinks and indicates your target zone.

Important Use and Safety Information

Read the following before using the heart rate or SmartRate features.

- Consult your physician before engaging in any vigorous exercise. Do not use the heart rate programs until authorized by your physician.
- Know your heart rate and your physician-recommended heart rate target zone. Individual heart rates vary according to several physiological factors and may not correspond directly with the following figure.
- Always face forward on the equipment and use the stationary handrail or handlebars for balance.

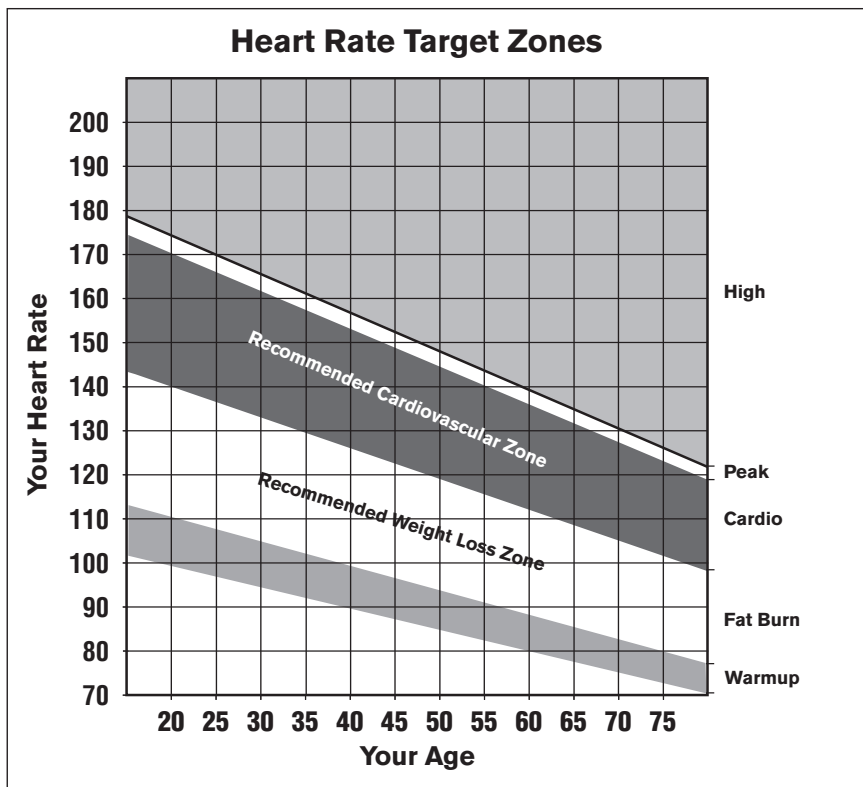

Figure 3: Heart rate target zones

- The calculation used for the heart rate target zone is:
 $(220 \text{ minus your age})$ multiplied by a percent.
 For example:
 Warmup range: $(220 \text{ minus your age})$ multiplied by 55%
 Peak range: $(220 \text{ minus your age})$ multiplied by 85%

- After you put on the chest strap, face the display console for a minimum of 15 seconds. This allows the receiver in the console to recognize the signal from the chest strap.
- If **Hr** blinks in the HEART RATE display, it is detecting a signal, but has not yet determined your heart rate. Make sure the chest strap is positioned properly around your chest and against your skin.
- If you prefer to use the touch-sensitive grips, grasp both and wait five to ten seconds. Make sure both hands are moist (not dry).
- When a signal is detected, a number flashes in the HEART RATE display and indicates your heart rate.

Wearing a Chest Strap

During a workout, the heart rate features appear on the display when you wear a chest strap. To receive an accurate reading, the chest strap needs to be in direct contact with your skin.

1. Carefully dampen the back of the strap with tap water. Refer to the following figure.

Note: Do not use deionized water. It does not have the proper minerals and salts to conduct electrical impulses.

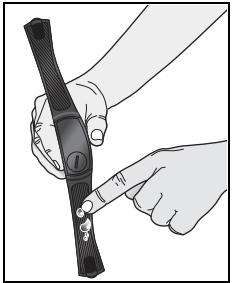

Figure 4: Moisten chest strap

2. Adjust the strap and fasten it around your chest. The strap should feel snug, not restrictive. Refer to the following figure.

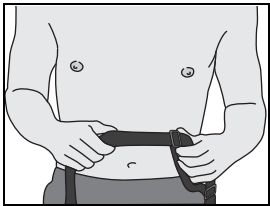

Figure 5: Adjust chest strap

3. Make sure that the chest strap is right side up, lies horizontally across your chest, and is centered in the middle of your chest. Refer to the following figure.

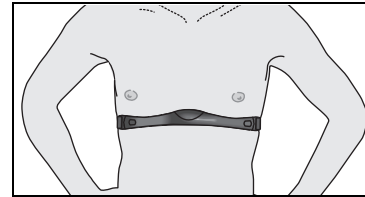

Figure 6: Fasten chest strap

After you put on the chest strap, face the display console for a few seconds. This allows the receiver in the console to recognize the signal from the chest strap.

Using the Touch-Sensitive Grips

While exercising, you must grasp both touch-sensitive grips for a minimum of five to ten seconds to transmit your heart rate to the display. Refer to the following figure.

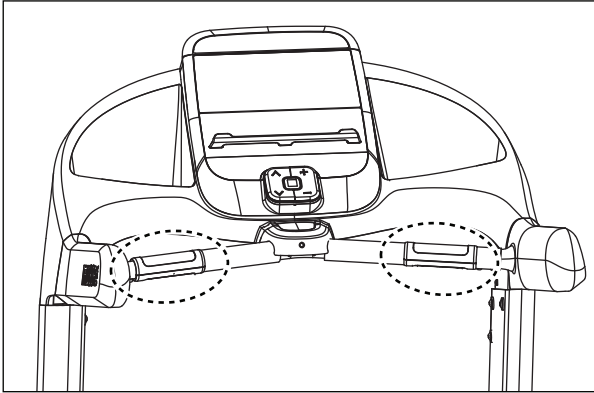

Figure 7: Touch-sensitive grips

Usually, the concentration of salts in a person's perspiration provides enough conductivity to transmit a signal to the receiver inside the display console. However, some people, because of body chemistry or erratic heart beats, cannot use the touch-sensitive grips. A chest strap may provide better results.

Important: While exercising, do not wear a chest strap and grasp the touch-sensitive grips at the same time. Using both features may cause erratic heart rate readings.

Using SmartRate

The SmartRate feature helps you monitor and maintain your heart rate in the target zone best suited to your specific needs. When a heart rate signal is detected, a single LED blinks and indicates the zone that your heart rate is in.

Important: To use the SmartRate feature, you must enter your age. If you were not prompted for your age during program selection, press the **OPTIONS** key and enter your weight and age. Refer to Addressing Your Weight and Age.

The 10 LEDs in the SmartRate display are color-coded. Pulsating orange LEDs indicate you are exercising outside the recommended heart rate target zone. Green LEDs indicate when you are exercising within the recommended fat burn or cardio fitness zones.

The following table shows the percents used in calculating the heart rate target zones. While your heart rate remains within these zones, the corresponding light blinks and provides a visual cue.

CAUTION: Your heart rate should never exceed 85% of your maximum aerobic heart rate or go above PEAK. If it does, immediately reduce the intensity of your workout to return your heart rate to your physician-recommended target zone.

Table 1. Heart rate target zones and SmartRate LEDs

Heart Rate Zone Percent	LED Lit	LED Blinking	Zone Label
Below 50	First	Orange	WARMUP
50 to 54	Second	Orange	WARMUP
55 to 59	Third	Green	FAT BURN
60 to 64	Fourth	Green	FAT BURN
65 to 69	Fifth	Green	FAT BURN
70 to 74	Sixth	Green	CARDIO
75 to 79	Seventh	Green	CARDIO
80 to 84	Eighth	Green	CARDIO
85 to 87	Ninth	Orange	PEAK
Above 87	Tenth	Orange	HIGH

The SmartRate indicator lights do not blink when:

- You do not wear or improperly position the chest strap. Or, you fail to grasp both touch-sensitive grips for five to ten seconds.
- You do not enter your age during an exercise session.

For example, pressing QUICKSTART at the Precor banner causes the Manual Program to begin. Your age has not been entered and is considered a null value. Your heart rate will appear in the HEART RATE display when you hold onto the touch-sensitive grips or wear a chest strap, but none of the SmartRate LEDs blink because the appropriate calculations have not been made.

Note: You can remedy this situation by pressing the OPTIONS key and entering your weight and age. Refer to *Addressing Your Weight and Age*.

Exercise to Your Target Heart Rate

A dedicated window displays your heart rate while you exercise. To view your heart rate (beats per minute) on the display, either wear a chest strap or grasp both touch-sensitive grips.

The Precor web site (www.precor.com) has several suggestions for workouts with varying levels of intensity. It provides many workout details that include the appropriate target heart rate.

The equipment includes one or more heart rate programs that let you exercise based on a specified target heart rate. As you exercise, the programs monitor your heart rate and automatically maintain it within a few beats per minute of your selected target. To use these programs, press the PROGRAMS – HEART RATE key. For more information, refer to *Programs*.

Heart Rate Analysis

Every time you complete a program using the chest strap or touch-sensitive grips, the display provides a heart rate analysis after the workout summary. Refer to *Ending a Workout*.

Your average heart rate appears followed by the maximum heart rate achieved during your workout. A third display appears, if you entered your age, and indicates the amount of time your heart rate remained between the target zones shown.

The heart rate analysis is based on how often your heart rate signal is received while exercising. If you use the chest strap, the average heart rate will be more accurate than if you occasionally grasp the touch-sensitive grips.

Troubleshooting Heart Rate

The following table may help you understand and troubleshoot erratic heart rate readings.

Important: A heart rate can only be detected when the Precor heart rate receiver is properly installed in the display. A user must wear the chest strap or grasp both touch-sensitive grips.

Table 2. Erratic heart rate readings

What appears on the display	Cause	What to do
Nothing	The heart rate receiver is not installed or it has been disconnected.	Call Customer Support. Refer to <i>Obtaining Service</i> .
HR or Hr	A signal is being detected through the chest strap or the touch-sensitive grips, but a valid heart rate is not yet established.	Be sure that the chest strap is moist, centered, and in direct contact with your skin. If you are using the touch-sensitive grips, continue to grasp both of them. Wait a few moments for your heart rate to appear.

Note: To conduct electrical impulses from a user's heart, both touch-sensitive grips must be grasped firmly for five to ten seconds. Usually, the concentration of salts in a person's perspiration provides enough conductivity to transmit a signal to the receiver in the display console. However, because of body chemistry or erratic heartbeats, some people cannot use the touch-sensitive grips. A chest strap may provide better results.

Display Console

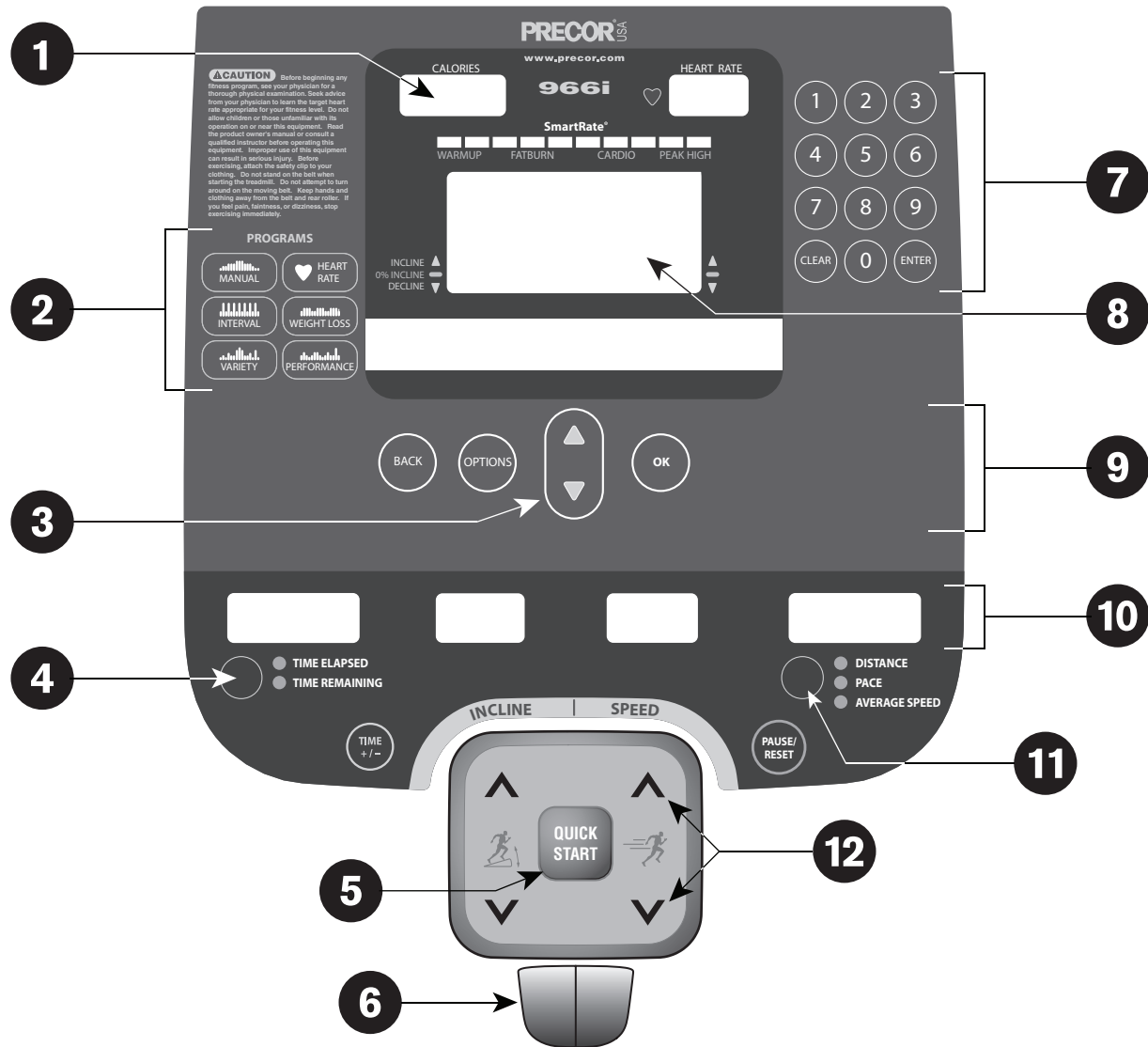

- 1 CALORIES display:** The estimated cumulative number of calories being burned appears.
- 2 Center display and the PROGRAMS keypad:** When you press a PROGRAMS key, the program profile appears in the upper display and the program name appears in the center display. During your session, additional information appears in the center display depending on program and user selections.
- 3 Navigational arrow keys:** These keys let you display exercise information prior to selecting it with the OK key.
- 4 Left selection key:** Press the key to select which item you wish to display during your session. Indicator lights appear next to the item that is displayed. You can perform the same function with the Right selection key.
- 5 QUICKSTART:** Press QUICKSTART to begin your workout immediately.
- 6 Red STOP button:** Press to pause or end a workout.
- 7 Number keys:** During an exercise session, use the number keys to answer prompts or update information. If the entertainment option is attached, the number keys act as TV channel controls.
- 8 Upper display:** Initially shows the Precor banner. It changes to the program profile when you select a program or press QUICKSTART. A blinking column in the profile indicates your position.
- 9 Navigational keys:** These keys let you display or change exercise information and end your session. For more information, refer to *Navigational Keypad*.
- 10 Lower display:** While you exercise, four sets of numbers show information about your session.
- 11 Right selection key**
- 12 INCLINE & SPEED keys:** Use these keys to adjust the incline or speed.

More Information about the Upper Display

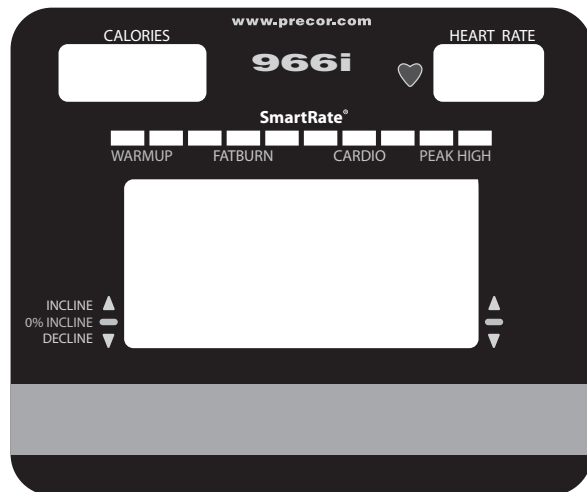

The upper display includes the CALORIES, HEART RATE, SmartRate, and a program profile display. The following descriptions explain what appears in the displays.

CALORIES—indicates the estimated cumulative number of calories being burned.

HEART RATE—displays your heart rate when you wear a chest strap or grasp both touch-sensitive grips. Refer to *Heart Rate Features*.

SmartRate—displays your heart rate as a blinking segment which indicates the zone your heart rate is in when you enter your age and wear a chest strap or grasp both touch-sensitive grips. Use this display as a visual aid to keep your heart rate in your preferred zone. Refer to *Using SmartRate*.

Program profile—appears during your exercise session. A blinking segment in the profile indicates your position. In most programs, the INCLINE setting affects the column height as shown in the following figures. The profile raises or lowers according to which INCLINE key is pressed.

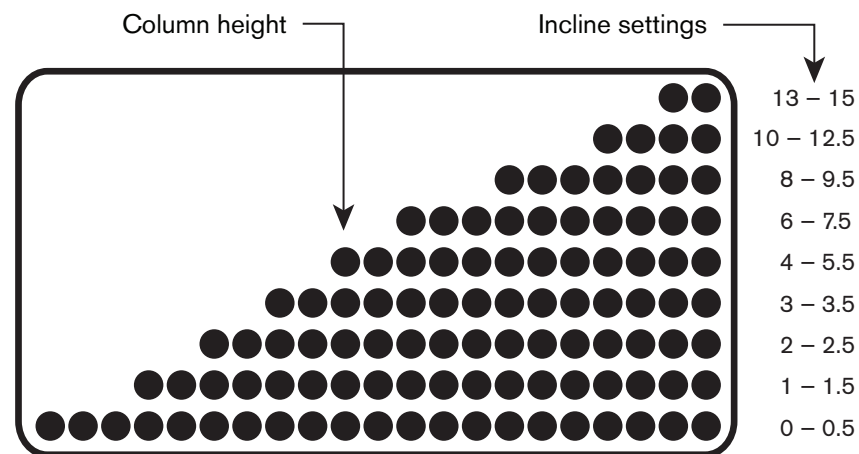

Figure 8: Column height in the 956i program profile

The range of incline differs on the 966i treadmill. The height remains at 15%, but you can choose a descending grade up to a minus 3%. Refer to the following figure.

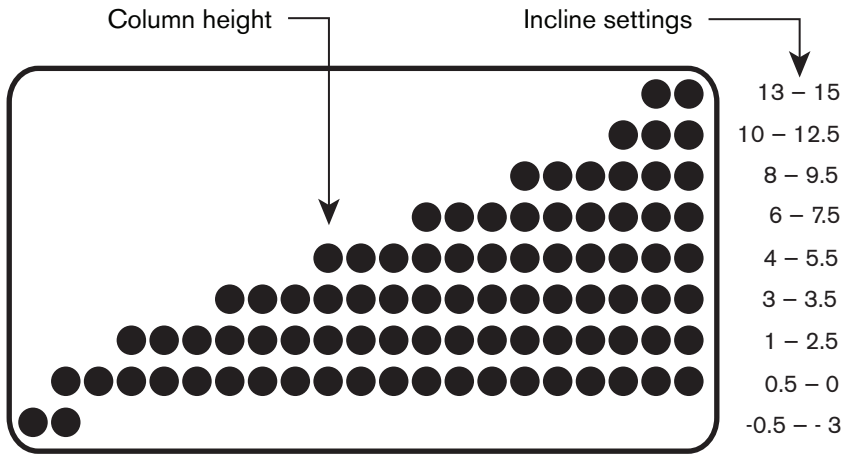

Figure 9: Column height in the 966i program profile

Ten dots display the range of incline on the 946i treadmill. Refer to the following figure.

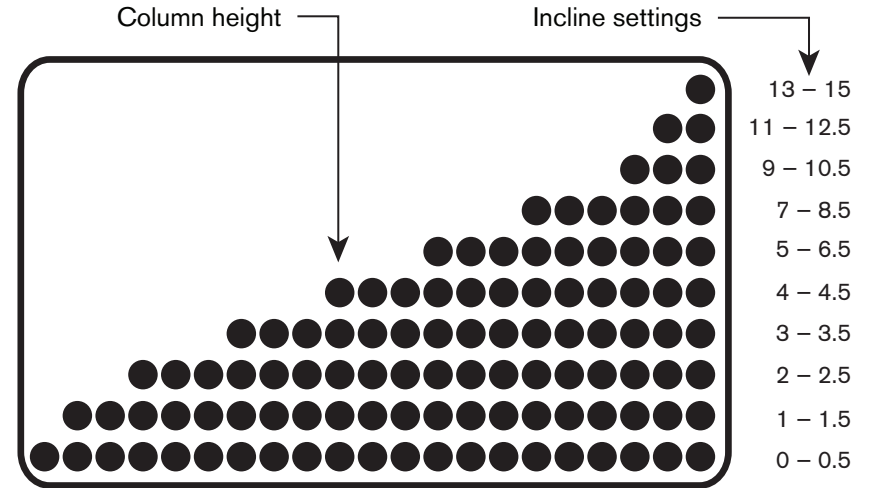
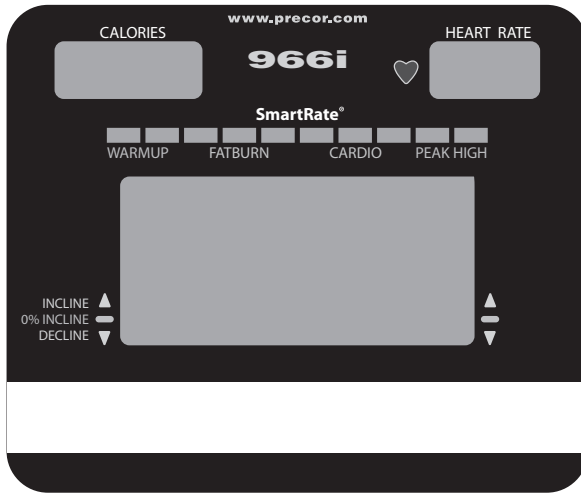

Figure 10: Column height in the 946i program profile

More Information about the Center Display



The center display presents the program name when you select a program. During an exercise session, the center display becomes a message bar showing additional information depending on user selections and program interludes. For more information about the selections that can appear in this display, refer to *Exercise Session*.

More Information about the Lower Display

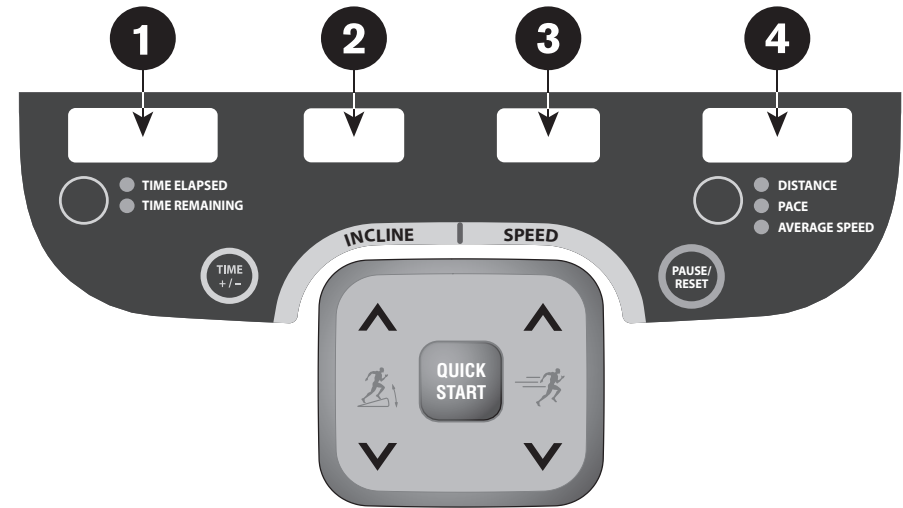

The lower display provides information about your workout session. Pressing the keys beneath each window affects what appears in the displays. Each display provides information about your workout statistics and is described in the list below.

Note: If you choose to rest a book or magazine on the display, you can still view these workout statistics.

1 TIME ELAPSED and TIME REMAINING

TIME ELAPSED—displays time in minutes and seconds and indicates the amount of time you have been exercising. When you exceed 60 minutes during a single session, the display converts to hours and minutes.

Note: The fitness facility can place limits on workout time.

TIME REMAINING—shows the amount of time remaining in a workout. If the selected time is less than 60 minutes, the display shows time in minutes and seconds. If you select a time greater than 60 minutes, the display reflects hours and minutes until the countdown reaches 60 minutes, at which time the display reverts to minutes and seconds.

Note: If you select a NO LIMIT time goal, the TIME REMAINING display appears blank. Press the left selection key if you wish to display elapsed time.

2 INCLINE

INCLINE—displays the percentage of incline or decline during your workout. The INCLINE keys affect the lift and let you set an incline between 0% and 15% (956i/946i) and a minus 3% to 15% (966i). The values displayed can change in 0.5% increments.

3 SPEED

SPEED—displays the running belt speed in miles per hour (mph) or kilometers per hour (kph). The running belt speed ranges between 0.5 and 16 mph (0.8 to 25.5 kph) on the 956i and 966i treadmills. The 946i has a range of 0.5 to 12 mph (0.8 to 20 kph). The speed can be changed in 0.1 increments using the SPEED keys.

Note: You can press the SPEED down key to stop the running belt. When 0 appears in the SPEED display, the running belt stops.

4 DISTANCE, PACE, and AVERAGE SPEED

DISTANCE—shows linear distance in either miles or kilometers. The distance is calculated based on your speed.

PACE—displays your target speed in minutes and seconds per mile (or kilometer). For example, the number 4:23 indicates that your pace (speed at which you are moving) is 4 minutes and 23 seconds per mile.

AVERAGE SPEED—indicates the average speed associated with your workout.

Keypads

Use the keypads to enter your exercise session selections and display preferences.

Distinct keypads exist on the display and are discussed in this section:

- Lower Display keypad and the selection keys
- Navigational keypad in the center of the display
- PROGRAMS keypad
- Number keypad with the ENTER and CLEAR keys

Lower Display Keypad and the Selection Keys

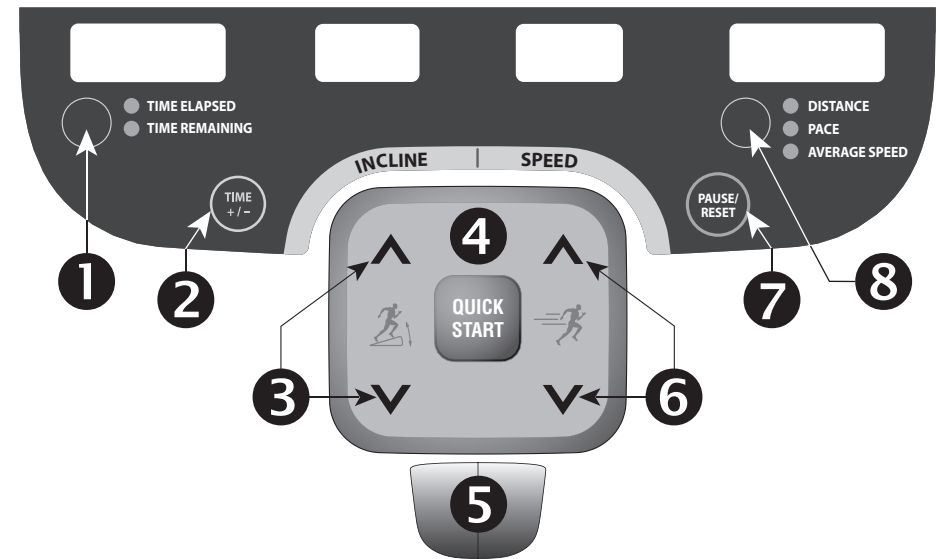

Figure 11: Lower Display keypad and the Selection keys

- 1 Left selection key:** Every time you press this key, the display reflects either the amount of time elapsed since you began your exercise session or it shows the time remaining. An LED lights and indicates which information is being displayed.
- 2 TIME +/-:** You can change the workout time while you are exercising, by pressing the TIME +/- key. A blinking number appears in the display. You can change the number using the navigational arrow keys or enter a different time using the number keys. Refer to *Changing Your Workout Display Options*.

3 INCLINE: Press and hold an INCLINE key to increase or decrease the incline from 0% to 15% (956i or 946i) or from minus 3% to positive 15% (966i) in 0.5% increments.

Changes to the incline are not immediate. It takes time for the lift to reach the target incline shown on the display.

4 QUICKSTART: Press QUICKSTART to start your exercise session immediately using the Manual Program. Refer to *Choosing QUICKSTART*.

5 STOP: A firm tap on the red STOP button slows the running belt to a stop and the treadmill enters pause mode. To resume, press QUICKSTART and enter the safety code, if necessary. Refer to *Pausing During a Workout or the Cool-Down Period*.

6 SPEED: Press and hold a SPEED key to increase or decrease the running belt speed in 0.1 increments.

When you press a SPEED key, a target speed appears in the display. The running belt speed changes to meet the target, but the change occurs gradually so the transition is smooth.

7 PAUSE/RESET: This key has several functions during an exercise session. Press it once to enter pause mode. Press it again to display a workout summary. Press it a third time to end your session and return to the Precor banner. Refer to *Pausing During a Workout or the Cool-Down Period*.

8 Right selection key: Every time you press this key, the display reflects the distance traveled since you began your exercise session, your current pace, or your average speed. An LED lights and indicates which information is being displayed.

Navigational Keypad

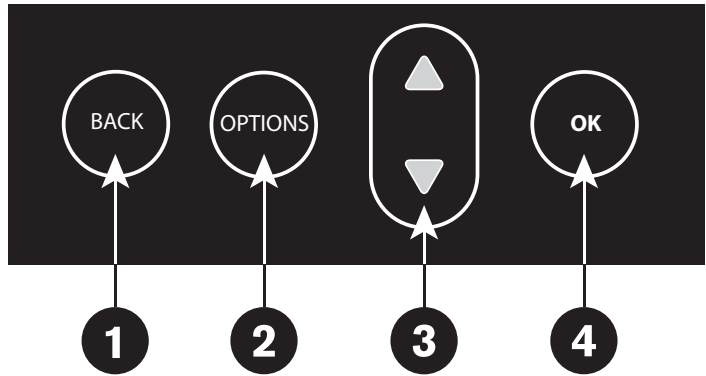

- 1 BACK:** When the BACK key is pressed it causes the display to return to the previous menu level.
- 2 OPTIONS:** The OPTIONS key is a multi-functional key. It lets you customize the display and set exercise session goals: time, calories, or distance. You can set your preferences prior to selecting a program or after you are already engaged in exercising. Refer to *Setting Display Preferences Before Exercising* or *Changing Your Workout Display Options*.
- 3 Up and Down Arrows:** These keys present the available selections and affect what appears on the display. Throughout this manual they are referred to as the navigational arrow keys.
- 4 OK:** Use the OK key to confirm responses to specific prompts.

PROGRAMS Keypad

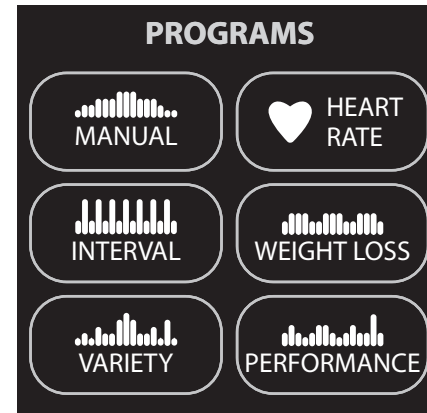

The PROGRAMS keypad provides access to all the exercise programs. Press the center of the key to view the top level program in its menu. Pressing the key again displays the next program in the menu, if one is available, as shown in the following table. For a description of each program, refer to *Programs*.

Note: Use the OK key to confirm your selection. For more information, refer to *Workout Options*.

Table 3. Available programs

PROGRAMS key	Program Menu	946i	956i	966i
MANUAL	MANUAL	✓	✓	✓
INTERVAL	1 - 1 INTERVAL	✓	✓	✓
	1 - 2 INTERVAL		✓	✓
	1 - 3 INTERVAL		✓	✓
	CUSTOM INTERVAL			✓
VARIETY	RANDOM	✓	✓	✓
	1 CROSS COUNTRY		✓	✓
	2 CROSS COUNTRY		✓	✓
	CROSS COUNTRY	✓		
	1 GLUTEAL		✓	✓
	2 GLUTEAL		✓	✓
	1 CUSTOM		✓	✓
	2 CUSTOM			✓
HEART RATE	BASIC HRC [†]	✓	✓	✓
	CUSTOM WEIGHT LOSS HRC [†]	✓	✓	✓
	WEIGHT LOSS HRC [†]	✓	✓	✓
	HEART HEALTH HRC [†]			✓
	ENDURANCE HRC [†]			✓
	SPEED HRC [†]			✓
WEIGHT LOSS	CUSTOM WEIGHT LOSS HRC [†]	✓	✓	✓
	WEIGHT LOSS HRC [†]	✓	✓	✓
	1 AEROBIC		✓	✓
	2 AEROBIC		✓	✓

PROGRAMS key	Program Menu	946i	956i	966i
	AEROBIC	✓		
PERFORMANCE	TRACK		✓	✓
	5 K	✓	✓	✓
	GERKIN FITNESS TEST*	✓	✓	✓
	USAF PRT*		✓	✓
	NAVY PRT*		✓	✓
	ARMY PFT*		✓	✓
	USMC PFT*		✓	✓
	FEDERAL LAW ENF. PEB*		✓	✓

* The fitness facility can limit access to the fitness tests.

† Use of chest strap or the touch-sensitive grips is required.

Number Keypad



The number keypad has several functions depending on what is connected to the equipment.

Connection	Description
Computer (CSAFE compatible)	If a computer is attached to the CSAFE connection on the equipment, the number keypad lets you enter your user ID and answer other setup prompts.
Entertainment Option	If an entertainment option is connected to the display, the number keypad acts as a remote control which you use to select the available channels. You can also enter number values in answer to exercise session prompts.
Nothing	Whether or not peripheral devices are attached to the equipment, the keypad lets you enter number values in answer to exercise session prompts. You need to press ENTER or OK to confirm the selection.

The CLEAR and ENTER keys provide the following functions:

CLEAR: Use the CLEAR key to remove the last number being displayed.

ENTER: Use the ENTER key to accept the number being displayed.

Note: The OK and ENTER keys are usually interchangeable and provide the same function when no peripheral devices are attached to the equipment. However, when answering prompts that originate from a CSAFE device or computer connection, use the ENTER key.

Workout Options

CAUTION: Before beginning any fitness program, see your physician for a complete physical examination. Know your physician-recommended heart rate target zone.

1. Turn the treadmill On. The Precor banner scrolls across the display.
2. Hold on to a handrail while stepping on to the treadmill.
3. Face the display and then straddle the running belt by placing your feet on the trim strips provided.
4. Attach the safety clip to your clothing.
5. Grip a handrail with one hand to steady yourself.

6. Select one of the following options:

Option...	Steps...
To start exercising immediately	<ul style="list-style-type: none">• Use the QUICKSTART key.• Refer to <i>Choosing QUICKSTART</i>.
To select a program	<ul style="list-style-type: none">• Press a PROGRAMS key.• Refer to <i>Selecting a Program</i>.
To enter a user ID	<ul style="list-style-type: none">• Use the ENTER key.• Refer to <i>Storing Workout Statistics</i>.
To set display preferences or program goals	<ul style="list-style-type: none">• Use the OPTIONS key.• Refer to <i>Setting Display Preferences Before Exercising</i>.

Important: If the safety code is enabled, you will need to enter a code to begin your workout. At the safety code prompt, press the following number key sequence: 1, 2, 3, 4. If you make a mistake, press any key a few times to reset to the safety code prompt, or wait two minutes for the banner to return.

Choosing QUICKSTART



1. While the Precor banner scrolls, press QUICKSTART to begin the Manual Program.

QUICKSTART applies the following defaults:

Prompts	Default Value
Program	Manual
Time	Fitness Facility setting
Weight	150 lb (68 kg)
Age	0

2. If needed, enter the safety code by pressing: 1, 2, 3, 4.
An asterisk appears on the display with each entry.

3. Hold onto a handrail and straddle the running belt.

A 3-second countdown appears on the display, and then the running belt starts moving.

4. Step on to the running belt with the speed at or below 1 mph or 1 kph and begin your workout. Use the SPEED up key to increase the speed of the running belt.

Note: To use the SmartRate feature, you need to specify your age and wear a chest strap or grasp both touch-sensitive grips. When a program begins, press OPTIONS and follow the prompts to enter your weight and age. You can use navigational arrow keys or the number keypad to change the blinking prompts. Press OK to confirm your selections.

Selecting a Program

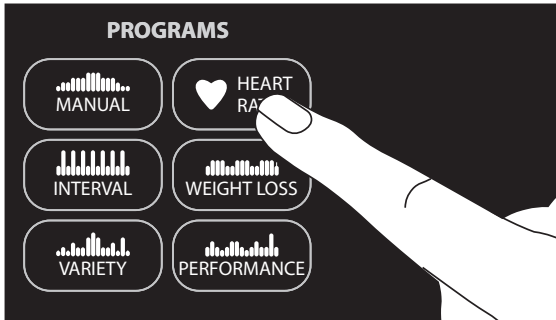

1. While the Precor banner scrolls, press one of the PROGRAMS keys, and then press OK. For a description of each program, refer to *Programs*.
2. If needed, enter the safety code by pressing: 1, 2, 3, 4.
An asterisk appears on the display with each entry.
3. Hold onto a handrail and straddle the running belt.
A 3-second countdown appears on the display, and then the running belt starts moving.

4. Step on to the running belt with the speed at or below 1 mph or 1 kph and begin your workout. Use the SPEED up key to increase the speed of the running belt.

You may be able to exercise indefinitely in any program (except 5K, distance and calorie goal programs, and performance fitness tests). Once you begin a program, press the TIME +/- key. A workout time blinks in the display. Use the number keypad to type in 240, and then press the up arrow key to display NO LIMIT. Press OK. The fitness facility can set limits for workout, pause, and cool-down times. So, selecting an unlimited workout time may not be allowed. Check with your fitness facility manager.

If you choose this option, the automatic cool-down period is eliminated. You will need to incorporate a cool-down period by accessing the Manual Program.

Note: To use the SmartRate feature, you need to specify your age and wear a chest strap or grasp both touch-sensitive grips. When a program begins, press OPTIONS and follow the prompts to address your weight and age. You can use navigational arrow keys or the number keypad to change the blinking number prompts. Press OK to confirm your selection.

Storing Workout Statistics

Many fitness facilities connect Precor equipment to a computer so you can easily retrieve your workout statistics and determine how well you are meeting your fitness goals. If you are interested in maintaining workout statistic information, ask the manager to create a user account and a user ID for you. A user ID entry is required to store your statistics.

Note: If the display is blank, make sure that the equipment is turned On. If the Precor banner appears, the equipment is not connected to a computer. Refer to *Selecting a Program* or *Choosing QUICKSTART*.

If the equipment is connected to a computer, the following appears:

CHOOSE QUICKSTART, ENTER, OR A PROGRAM TO BEGIN

To save the statistics generated during your exercise session, take the following steps:

1. Press ENTER.
2. Use the number keypad to specify your 5-digit user ID. If you make a mistake, press the CLEAR key and reenter the correct number.
3. When your user ID is shown, press ENTER.

A message appears and indicates when the user ID is accepted by the computer.

4. To begin your exercise session, select a program. Refer to *Selecting a Program*.

Note: To bypass the user ID entry, press ENTER while all five zeros appear in the user ID field. The statistics generated during your exercise session will not be added to your file.

Setting Display Preferences Before Exercising

While the Precor banner scrolls, you have the opportunity to set display preferences and program goals.

Once you set your preferences, you have a 5-second window to select a program. If you do not select a program from the PROGRAMS menu or press QUICKSTART within the 5-second window, the preferences return to the fitness facility settings.

1. As the Precor banner scrolls, press OPTIONS. Continue to press the key to view the menu options.
2. Use the navigational arrow keys to display each menu option or preference. Press OK to select it.

3. Follow the prompts on the display and return to the Precor banner.

Menu Option	Preferences	Effect
GOAL	TIME, CALORIES, or DISTANCE	Sets the program goal.
LANGUAGE	ENGLISH, DEUTSCH, ESPANOL, FRANCAIS, NEDERLANDS, PORTUGUES, RUCCKIJJ, and ITALIANO.	Causes the display messages and prompts to appear in the chosen language.
UNITS	U.S. or METRIC	Determines which units of measure appear on the display.

Note: The selections that you make prior to a workout reset to the fitness facility settings once your program or the pause time limit ends.

Cooling Down After a Workout

Incorporate a cool-down period into your workout to help lower your heart rate and minimize muscle stiffness or soreness.

When you complete a program with a time limit or specified goal, you automatically enter a cool-down period. The settings change to help reduce the intensity of your workout.

Note: You cannot switch to a different program, goal, or workout time during the cool-down period. Any pressure on the PROGRAMS keys is ignored.

A workout summary appears at the end of the cool-down period. Refer to *Ending a Workout*.

A cool-down period will not be appended to your exercise session if the following occurs:

- The fitness facility allows an unlimited time goal. A user must enter a time goal of NO LIMIT to access this option. Refer to *Selecting a Program*.
- The fitness facility sets a cool-down time of zero, which eliminates the cool-down phase.
- You exit a program before completing it.

If you specify an unlimited time or the fitness facility removed the cool-down phase, remember to incorporate a cool-down period at the end of your exercise session.

Pausing During a Workout or the Cool-Down Period

Press the red STOP button or the PAUSE/RESET key to pause anytime during a workout or during a cool-down period. The pause mode is limited to two minutes or less. If you do not resume exercising during that time, the display returns to the banner.

1. To pause, press the red STOP button or the PAUSE/RESET key.
2. To resume exercising from pause mode, press QUICKSTART or the SPEED up key.
3. If needed, enter the password by pressing: 1, 2, 3, 4.

An asterisk appears on the display with each entry.

Note: When you pause, you can change your program selection or display options. Refer to *Changing Programs in Mid-session* and *Changing Your Workout Display Options*.

Ending a Workout

CAUTION: Hold on to a handrail when you near the end of your exercise session. The incline automatically recalibrates to a default grade. If the lift is moving, wait until it stops before stepping off the treadmill.

The running belt stops when you complete the automatic cool-down period. After the running belt stops, time stops accruing.

The workout summary appears and shows your cumulative workout statistics including warm-up and cool-down periods. You can review your statistics for two minutes before the display automatically resets to the Precor banner.

If you hold onto the touch-sensitive grips or wear a chest strap while exercising, a heart rate analysis appears during the workout summary. Refer to *Heart Rate Analysis*.

If you choose to exercise with no set time limit, you must manually end a program by pressing the red STOP button or the PAUSE/RESET key. You can also press the SPEED down key until the speed is reduced to zero and the running belt stops.

To stop the running belt or end a workout session, do the following:

1. Grasp a handrail with one hand.
2. Press the red STOP button or the PAUSE/RESET key with your other hand. The treadmill enters pause mode.
3. Press PAUSE/RESET to view the workout summary.
While WORKOUT SUMMARY scrolls across the display, press the selection keys to highlight more statistics.
4. Press PAUSE/RESET again to return to the Precor banner.

Note: The red STOP button and the PAUSE/RESET key can be used interchangeably.

Programs

This section describes the programs available on the equipment. Use this section as a reference tool to better understand each program's purpose.

Choosing a Program

Choosing a program depends on your goals. If you are a beginner or returning to regular exercise, you can start a cardio-conditioning program to slowly return your body to a comfortable level of exercise. If you have been exercising and feel that you have an intermediate or advanced fitness level, you probably have established goals. The Precor web site (www.precor.com) can give you many ideas about fitness routines and advice from the experts.

Several of the exercise choices on the equipment are preprogrammed with recommended settings. However, you have the option to override the suggested settings, with some exceptions. If changes are not allowed, a message scrolls across the display explaining your options.

If your level of exertion becomes too great, reduce your level of intensity by overriding each upcoming segment in the program profile. When you complete a program that contains a time limit or goal period, an automatic cool-down period begins.

Program Tips

- Begin at the Precor banner and choose a program by pressing PROGRAMS or QUICKSTART. Hold onto a handrail as the running belt begins moving after a 3-second countdown. Refer to *Workout Options*.
- A blinking column indicates your position as you progress through a program.
- Prior to choosing a program, you may press the OPTIONS key to access goal, language, or units of measure settings. After pressing OK to confirm new settings, you must select a program within five seconds for the changes to become effective. Refer to *Setting Display Preferences Before Exercising*.
- To use the SmartRate feature, you need to specify your age and wear a chest strap or hold on to the touch-sensitive grips. For more information, refer to *Changing Your Workout Display Options*.
- In some programs, an unlimited time setting may be an available option. Refer to *Selecting a Program*.

- The fitness facility can set limits on workout, pause, and cool-down times and customize other aspects of your exercise session. Check with your manager to learn if any limits are in place that might affect your program selections.
- To pause during a program, press PAUSE/RESET. Refer to *Pausing During a Workout or the Cool-Down Period*.

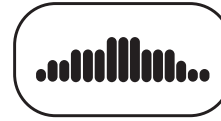

Manual Program

The Manual Program profile, available by pressing the MANUAL key, begins as a flat line. You control incline and speed using the INCLINE or SPEED keys. The program profile reflects any changes. The blinking column indicates your position in the program.

A cool-down period occurs automatically when you end your workout. An exception to the cool-down period exists if the fitness facility allows it. Refer to *Cooling Down After a Workout* for more information.

Note: To use the SmartRate feature, you need to specify your age by pressing the OPTIONS key and following the display prompts. To change the workout time, press the TIME +/- key. Refer to *Changing the Workout Time*.



Interval Program

The Interval Programs, available by pressing the INTERVAL key, are among the best for conditioning your cardiovascular system. Each program raises and lowers your level of exertion repeatedly for the specified period of time.

Three programs let you choose the rest and work intervals according to your training regimen.

Note: Only the first program is available on the 946i treadmill.

Interval Program	Rest Duration	Work Duration
1-1 Interval	2 minutes	2 minutes
1-2 Interval	2 minutes	4 minutes
1-3 Interval	2 minutes	6 minutes
Custom Interval (966i)	user specified	user specified

Initially, the rest interval is set to 0% grade and 1 mph or 1 kph. The work interval is set at a 3% grade and the speed remains at 1 mph or 1 kph.

While exercising, you can vary the speed and change the preset incline using the INCLINE or SPEED keys. The settings are repeated throughout the remainder of the program.

Note: Incline changes are limited to +/- 5% grade variance from the previous incline level.

The display lets you know when the speed or incline levels are about to change, and indicates the levels of the next interval.

A Custom Interval Program is available on the 966i. It lets you specify the time durations for the rest and work intervals.

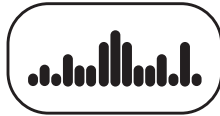

Random Program

The Random Program can be accessed by pressing the VARIETY key. Every time the Random program is selected, a different program profile appears. The columns that appear in the program profile show the preprogrammed incline. You can override the preprogrammed incline at any time using the INCLINE keys.

The running belt speed is completely under your control. You can adjust the pace by pressing the SPEED keys.

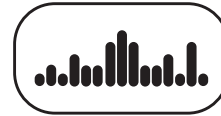

Cross Country Program

The two Cross Country Programs, available by pressing the VARIETY key, are designed to provide a more realistic terrain as if you were running or walking in the outdoors. Review the profiles to determine the ascent and descent levels of each program.

Note: Only the first program is available on the 946i treadmill.

The goal in a Cross Country Program is time, but if you prefer a distance goal, you can press the OPTIONS key. Refer to *Changing Your Workout Display Options*. Once you select a distance goal, the TIME REMAINING recalculates based on the speed of the running belt.

Anytime during a workout, you can override the incline settings by pressing the INCLINE keys. The remaining profile columns change accordingly. The changes are saved and applied throughout the remainder of the program. You can adjust the pace by pressing the SPEED keys.

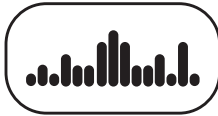

966i/956i Gluteal Programs

The two Gluteal Programs, available by pressing the VARIETY key, are designed to exercise the gluteal muscles. The incline is preprogrammed. Review the profiles to determine the ascent and descent levels of each program.

Anytime during a workout, you can override the incline settings by pressing the INCLINE keys. The remaining profile columns change accordingly. The changes are saved and applied throughout the remainder of the program. To change the pace, use the SPEED keys.



966i/956i Custom Programs

The two Custom Programs, available by pressing the VARIETY key, provide variable preprogrammed inclines. Fitness personnel in the fitness facility have the option to create a profile customized for its patrons.

Similar to other treadmill programs that have preprogrammed inclines, you can override the incline settings using the INCLINE keys. The changes are applied to the remaining profile. To change the pace, use the SPEED keys.



Heart Rate Programs

The Heart Rate Programs let you set a target for your heart rate. These programs adjust the incline and speed to maintain your heart rate within two beats per minute of the target heart rate while you exercise. To use these programs, you must enter your age and wear a chest strap so your heart rate can be monitored throughout the session.

Important: Consult your physician to determine the appropriate target heart rate for your age and fitness level. If your physician recommends a different target heart rate than the one that appears on the display, use the navigational arrow keys to change the target heart rate once you finish the warm-up period. Do not exercise over the recommended range.

Heart Rate Program Tips

The Heart Rate Programs enhance your overall cardiovascular fitness levels to help you achieve your weight loss and fitness goals. Read through the following tips before selecting a program. These tips provide general information regarding how the programs function. The following table briefly explains the available programs. For more information and exercise suggestions, refer to the Precor web site at www.precor.com.

- Each program provides a 3-minute warm-up period. During this time, you may change the incline or speed, but you cannot change the goal setting.
Note: When your target heart rate is achieved or the 3-minute period elapses, the warm-up period ends and the program begins, at which point, you may change to a distance or calorie goal.
- Each program automatically adjusts the incline to keep your heart rate at the selected target. After the warm-up period, pressing the INCLINE keys no longer affects the incline motor. Check the SmartRate display to see if you are maintaining your preferred zone. Check the HEART RATE display to determine your actual heart rate. For information about understanding your target heart rate, refer to *Heart Rate Features*.

- You can press the SPEED keys to adjust the speed and press the navigational arrow keys to change the target heart rate during your exercise session. The display lets you know when changes to either are about to occur.
Note: Changing the target heart rate or speed affects the treadmill's ability to maintain your target heart rate in the preferred zone. It takes time for the treadmill to readjust the incline so that your heart rate remains on target.
- In several of the programs, the workout time is automatically set. To adjust the time, press the TIME +/- key and use the navigational arrow keys followed by OK to change the workout time.
Note: A fixed time exists for the Custom Weight Loss HRC Program, so you cannot change it. The 966i Heart Health, Endurance, and Speed HRC Programs have a minimum workout time of 15 minutes.
- If you wish to quit a heart rate program, you can make a mid-session transfer to another program. If you try to return or transfer mid-session to a heart rate program, messages scroll across the display stating your options.
- A cool-down period is automatically added to the end of each program.

If you are having difficulty with the heart rate features, talk to your fitness facility manager.

Table 4. Heart Rate Programs

Equipment	Program	Description
966i, 956i, 946i	Basic HRC	This program enhances your overall cardiovascular fitness level by keeping your heart rate within the recommended cardio zone based on your age. You must enter your age and hold onto the touch-sensitive grips or wear a chest strap while exercising.
966i, 956i, 946i	Custom Weight Loss HRC	This 28-minute program lets you set the rest and work target heart rates for seven 4-minute intervals. The recommended target heart rates appear on the display and are based on the Fat Burn scale. You must enter your age and hold onto the touch-sensitive grips or wear the chest strap while exercising. Use the SPEED keys to change the speed for the rest or work intervals. Use the INCLINE keys to change your target heart rate. When you make changes, the program repeats the settings for the remaining intervals. Note that you cannot make a mid-session change to this program.
966i, 956i, 946i	Weight Loss HRC	This program automatically adjusts the speed and incline to help you achieve weight loss and improve endurance. After the 3-minute warm-up period, heart rate readings are taken every minute and the speed or incline is adjusted to keep you in the appropriate target zone. You must enter your age and wear a chest strap while exercising. A time goal can be set between 15 and 90 minutes, but the fitness facility can override the higher range and require a shorter duration.
966i	Heart Health HRC	This program provides intervals between 3–10 minutes which maintain your heart rate in the higher cardiovascular range. If you have been exercising regularly, you might use this program to increase your metabolic rate, strengthen your heart muscle and improve endurance. With subsequent workouts, you will increase fat burning and your aerobic capacity. Similar to the Weight Loss HRC, heart rate readings are taken at specific intervals and the speed or incline is adjusted to keep you in the appropriate target zone. You must enter your age and wear a chest strap while exercising. A time goal can be set between 15 and 90 minutes, but the fitness facility can override the higher range and require a shorter duration.
966i	Endurance HRC	As the name implies, this program is a high-intensity session. It provides rest interval durations that are increased two-fold and applied to the work interval. The rest interval maintains your heart rate in the fat burn zones while the work interval increases the incline (or speed) to raise and maintain your heart rate in the cardio zones. You must enter your age and wear a chest strap while exercising. A time goal can be set between 15 and 90 minutes, but the fitness facility can override the higher range and require a shorter duration. The work interval time is limited to 20 minutes or less.
966i	Speed HRC	This program can be used to increase your anaerobic threshold power. If you do not know the difference between aerobic and anaerobic capacity, do not use this program. Check with a personal trainer or facilities personnel. The first interval in this program starts in the Peak zone. The second interval adjusts the incline (or speed) to maintain your heart rate between 80% and 65% of your target zone. The program repeats the settings for the remaining intervals. You must enter your age and wear a chest strap while exercising. A time goal can be set between 15 and 90 minutes, but the fitness facility can override the higher range and require a shorter duration. The work interval time is limited to 9 minutes or less.



Weight Loss Programs

The Weight Loss Programs begin with a warm-up period similar to the heart rate programs, except that the target heart rate is set in the lower fat burn range during the rest intervals. During the work intervals, the target heart rate is initially set to 220 minus age multiplied by 70%. The display lets you know when the incline levels are about to change.

For the ideal weight loss range, your heart rate should remain between 55% and 70% of your maximum aerobic heart rate. If you wear a chest strap or grasp both touch-sensitive grips, you can use SmartRate as a visual cue.

The Custom Weight Loss HRC and Weight Loss HRC Programs are described in the table in *Heart Rate Program Tips*. Two additional programs are available and include: 1 AEROBIC and 2 AEROBIC.

Note: The word AEROBIC without numbers appears on the 946i display.

Each program provides varying incline levels to induce fat burn and weight loss conditioning. Review the profiles to determine which program is appropriate for your level of fitness.

If you are using an Aerobic Program, you can override the incline settings for each column by pressing the INCLINE keys. The changes raise or lower the columns on the remaining portion of the program profile. You can adjust the pace by press the SPEED keys.

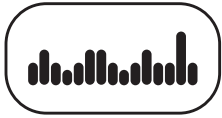

Track Program

The Track Program can be accessed by pressing the PERFORMANCE key. An oval track appears on the display. One lap around the track represents 440 yards (400 meters). A blinking LED moves counterclockwise and indicates your position on the track. You control incline and speed. The SEGMENT TIME REMAINING display, found in the OPTIONS menu, shows the remaining time required to complete the current lap based on your current speed.



5K Program

The 5K Program, available by pressing the PERFORMANCE key, is a good distance to run or walk depending on your level of fitness. The distance is fixed at five kilometers (3.1 miles) and cannot be changed. The incline is preprogrammed. You can change the speed and override the preprogrammed incline using the SPEED or INCLINE keys.

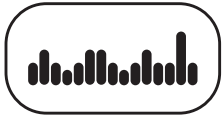

Fitness Tests

A variety of fitness tests are available on the equipment, but the fitness facility has the option to remove the program selections from the PERFORMANCE key menu. If you do not see the fitness tests as part of your program selections, ask the facility manager.

Fitness Test Tips

Read through the following tips before selecting a fitness test.

- Sit and rest for at least five minutes prior to taking the test.
- You must wear the chest strap throughout the Fitness Test. If the heart rate reception is erratic, incorrect readings can occur and terminate the test.
- You must enter your age, and in some cases, your gender and the altitude to begin a fitness test.
- The test provides a 3-minute warm-up period. During this time, you may change the incline or speed. When your target heart rate is achieved or the 3-minute period elapses, the warm-up period ends and the test begins.

Important: *If you need to stop the running belt to regain control or reduce your heart rate, please do so. You can retake the fitness test later. Complete the cool-down period and retake the fitness test later.*

- The red STOP button and the PAUSE/RESET key are enabled during the fitness tests. The SPEED keys are also enabled during the fitness tests, with the exception of the Gerkin Fitness Test.
- You cannot change the distance or time goals or change to another program while in the midst of taking a fitness test.
- If you press the red STOP button or the PAUSE/RESET key during the test, the test ends and the display indicates the test was not completed.
- Cool-down periods are appended to the end of each test.

Fitness Test Scores

When you finish a fitness test, a fitness score appears on the display as part of the workout summary. Check with the facility manager to compare your score with the appropriate fitness indexes. The test results can help you gauge the effectiveness of your current exercise routine and tailor it to meet your fitness goals.

Table 5. Fitness Tests

Equipment	Fitness Test	Description
966i, 956i	Gerkin Fitness Test	<p>This test provides a means of comparing your fitness level with the official fitness test of the International Association of Firefighters (IAFF). It is written using the Gerkin Protocol, which is the basis for the official IAFF fitness test and part of their Wellness and Fitness Initiative.</p> <p>During the test, the treadmill gradually increases the incline and speed in specific stages. The keypads are disabled. The test ends if no heart rate is detected for 15 seconds, you surpass your target heart rate (85% of your maximum aerobic heart rate), or you complete the 13-minute time limit. Whatever stage you are at when the test ends determines your aerobic capacity and establishes your VO2 max. Once you complete the test, a fitness score appears as part of the workout summary.</p> <p>Use it to compare to IAFF standards.</p>
966i, 956i	USAF Physical Fitness Test (PRT)	<p>This program has a set distance and a set incline at 1% grade. Throughout the test you can adjust the speed using the SPEED keys. All other keypads are disabled. Once you complete the test, a fitness score appears as part of the workout summary. Use it to compare to Air Force standards.</p>
966i, 956i	NAVY PRT	<p>This program has a set distance and a set incline at 1% grade. Throughout the test you can adjust the speed using the SPEED keys. All other keypads are disabled. Once you complete the test, a fitness score appears as part of the workout summary. Use it to compare to Navy standards.</p>
966i, 956i	ARMY PFT	<p>This program has a set distance and a level incline. Throughout the test you can adjust the speed using the SPEED keys. All other keypads are disabled. Once you complete the test, a fitness score appears as part of the workout summary. Use it to compare to Army standards.</p>
966i, 956i	USMC PFT	<p>This program has a set distance and a level incline. Throughout the test you can adjust the speed using the SPEED keys. All other keypads are disabled. Once you complete the test, a fitness score appears as part of the workout summary. Use it to compare to U.S. Marine Corps standards.</p>
966i, 956i	Federal Law Enforcement Physical Efficiency Battery (PEB)	<p>This program has a set distance and a level incline. Throughout the test you can adjust the speed using the SPEED keys. All other keypads are disabled. Once you complete the test, a fitness score appears as part of the workout summary. Use it to compare to Federal Law Enforcement standards.</p>

Exercise Session

This section describes how to access the following attributes through the use of the navigational keypad. Any display selections set during the course of your exercise session are reset to the fitness facility settings when you end your session and return to the Precor banner.

While exercising, you can:

- change the program you are using
- change the workout time
- enter your weight and age
- choose between time-, distance-, or calorie-type goals
- reset your target heart rate
- display more workout statistics
- choose between U.S. standard and Metric units of measure
- display messages and prompts in a different language

Note: Prior to selecting a program, you can select preferences for program goals, language and units of measure. Refer to *Setting Display Preferences Before Exercising*.

Changing Programs in Mid-session

You can change programs in the middle of a session by selecting a new program from the PROGRAMS key menu. All accumulated workout statistics are transferred to the new program as you continue exercising.

Certain programs are not available for mid-session transfers due to set goals and program preferences. If this occurs, a message scrolls across the display.

Changing the Workout Time

To change the duration of your program, take the following steps:

1. Press TIME +/-.
2. A workout time blinks in the display. Use the navigational arrow keys or the number keys to adjust the time.
3. Press OK.

A message scrolls across the display indicating that the new workout time has been accepted.

The fitness facility can limit the duration of exercise sessions and certain programs have fixed time goals which do not allow adjustments. If your attempt to change the workout time is not accepted, display messages scroll and indicate the reasons.

Addressing Your Weight and Age

Your age must be entered to activate the SmartRate display and to properly use the heart rate and weight loss programs. To enter or change your weight or age during an exercise session, take the following steps:

1. Press OPTIONS.
2. The prompt, WEIGHT / AGE appears. Press OK.

Note: If the weight and age are already entered, the WEIGHT / AGE prompt will not appear as part of the OPTIONS menu.

3. Use the number keys or navigational arrow keys to adjust the blinking weight prompt and then, press OK.
4. Use the number keys or navigational arrow keys to adjust the blinking age prompt and then, press OK.

A message scrolls across the display indicating that your weight and age have been accepted.

Adjusting Program Goals

To designate a distance, calories, or time goal while exercising take the following steps:

1. Press **OPTIONS**, and then press the down key on the navigational keypad until **GOAL** appears.

Note: If a program has a preset goal such as distance in the 5K Program or 28 minutes in the Weight Loss HRC Program, **GOAL** may not appear as part of the **OPTIONS** menu.

2. Press **OK**.
3. Press **OPTIONS** again or the down key on the navigational keypad to select between **TIME**, **CALORIES**, or **DISTANCE**.
4. When you are ready, press **OK** to select the displayed goal.

Selection	Description
TIME	A time-based goal is the setting for all programs. If you want to exercise for a set time, select this goal.
DISTANCE	A distance-based goal lets you select a set distance between 1 and 50 miles or kilometers (km).
CALORIES	A calories-based goal lets you exercise until you reach a set calorie amount between 1 and 1000.

5. A blinking number appears indicating that the system is ready for adjustments to the goal. Use the number keys or navigational arrow keys to change the setting.
6. When you are ready, press **OK**. If the program you are using allows changes to goal settings, a prompt scrolls across the display indicating that your selection has been accepted. The **TIME REMAINING** display changes according to the goal being set.

Note: Several programs on the treadmill are preset with distance or time goals and cannot be changed. If you try to change one, a brief message appears indicating that your attempt failed.

Adjusting Your Target Heart Rate

Your target heart rate can be adjusted anytime during your exercise session by taking the following steps:

1. Press **OPTIONS**, and then press the down key on the navigational keypad until **TARGET HR** appears.
2. Press **OK**.
3. A blinking number appears indicating the suggested target heart rate based on your age. Use the number keys or navigational arrow keys to change the setting.
4. When you are ready, press **OK**.

Important: Consult your physician to determine the appropriate target heart rate for your age and fitness level. If your physician recommends a different target heart rate than the one that appears on the display, change the target heart rate to match your physician's recommendation. Do not exercise over the recommended range.

Changing Your Workout Display Options

During an exercise session, the display becomes a message bar. It can show additional workout statistics depending on user selections accessed through the **OPTIONS** menu.

To display more workout statistics or choose one among them, take the following steps:

1. Press **OPTIONS**, and then press the down key on the navigational keypad until **MORE METRICS** appears.
2. Press **OK**.
3. Scroll through all the available workout statistic displays by continually pressing the down key on the navigational keypad. Refer to the following table.
4. When you are ready, press **OK** to select a displayed metric or display the entire menu consecutively, by selecting **SHOW ALL**.

Note: To remove a scrolling statistic from the message bar, you need to re-enter the **OPTIONS** menu and select a different workout statistic display or select **OFF**.

Table 6. Workout statistics using OPTIONS or METRICS key

Equipment	Menu	Description
All	% COMPLETE	Shows how much of the program goal you have completed.
All	TIME IN ZONE	Displays the total time that your heart rate is within the range of 55% to 84% of your target heart rate.
All	SEGMENT TIME REMAINING	Indicates the amount of time, in minutes and seconds, that remain in the highlighted column of the profile before the next column begins blinking.
AMT, climber	AVERAGE SPEED	Displays the average strides per minute.
Treadmills	AVERAGE SPEED	Displays the average miles or kilometers per hour. The number that appears is determined by dividing the total distance traveled by the elapsed time.
All	CALS / MIN	Displays the approximate number of calories burned per minute.
All	CALS / HR	Displays the approximate number of calories burned per hour.
All	WATTS	Shows your current energy expenditure level.
All	METS	Shows the metabolic units associated with your current energy expenditure level, derived from the calories per minute value and adjusted for your weight.
All	TARGET HR	Shows the current target heart rate setting.
All	AVG HEART RATE	Displays your average heart rate. The number is based on systematic sampling taken while you are exercising. A chest strap will give you a more accurate heart rate average than if you occasionally use the touch-sensitive grips. If no heart rate reading occurred during your exercise session, an analysis will not appear in the workout summary.
AMT	STRIDE LENGTH	Shows the current length of your stride in inches or centimeters.
Climber, treadmills	ELEVATION GAIN	Presents the cumulative steps (climber) or incline (treadmills) converted into elevation gained over the course of the program.
Treadmills	PACE	Displays your target speed in minutes and seconds per mile (or kilometer). For example, the number 4:23 indicates that your pace (speed at which you are moving) is 4 minutes and 23 seconds per mile.
All	SHOW ALL	Presents all the workout statistics in this menu in consecutive order.
All	OFF	Stops scrolling the workout statistics, found in this table, across the message bar.

Changing the Units of Measure

Display measurements can appear in either Metric or U.S. Standard. To change this setting, perform the following steps:

1. Press **OPTIONS**, and then press the down key on the navigational keypad until **UNITS** appears.
2. Press **OK**. **UNITS** scrolls across the display and is replaced by one of two options: **U.S.** or **METRIC**.
3. Toggle between the two options by pressing the down arrow key on the navigational keypad.
4. When you are ready, press **OK** to select the displayed unit of measure. A message scrolls across the display indicating that the unit of measure has changed.

Selecting a Language

You can choose to display text messages in several different languages. To select a different language before or during an exercise session, take the following steps:

1. Press **OPTIONS**, and then press the down key on the navigational keypad until **LANGUAGE** appears.
2. Press **OK**.
LANGUAGE scrolls across the display and is replaced by one of several language options.
3. Scroll through the available language options by continually pressing the down key on the navigational keypad.
4. When you are ready, press **OK** to select the displayed language. A message scrolls across the display indicating that the language has been changed.

946i/956i/966i Commercial Treadmills

Product Specifications

	946i	956i	966i
Length	79 in (204 cm)	88 in (224 cm)	88 in (224 cm)
Width	34 in (86 cm)	35 in (89 cm)	35 in (89 cm)
Height	59 in (150 cm)	64 in (163 cm)	64 in (163 cm)
Weight	331 lb (150 kg)	508 lb (231 kg)	508 lb (231 kg)
Shipping weight	346 lb (157 kg)	549 lb (249 kg)	549 lb (249 kg)
Running surface	56 in x 22 in (142 cm x 56 cm)	60 in x 20 in (153 cm x 51 cm)	60 in x 20 in (153 cm x 51 cm)
Motor	4.0 hp Peak duty	4.0 hp Peak duty	4.0 hp Peak duty
Power	120/240 VAC 50/60Hz	120/240 VAC 50/60Hz	120/240 VAC 50/60Hz
Speed	0.5–12 mph (1–20 kph)	0.5–16 mph (1–25.5 kph)	0.5–16 mph (1–25.5 kph)
Incline	0–15% grade	0–15% grade	-3%–15% grade
Frame	Powder-coated steel	Powder-coated steel	Powder-coated steel
Regulatory Approvals	FCC, ETL, CE, EN957	FCC, ETL, CE, EN957	FCC, ETL, CE, EN957

Product Features

CSAFE Compatible
Entertainment Option Available
Heart Rate Telemetry
QuickStart™
SmartRate®
Touch Heart Rate
Safety Code

Programs

	946i	956i	966i
Manual	✓	✓	✓
Interval			
1-1 Interval	✓	✓	✓
1-2 Interval		✓	✓
1-3 Interval		✓	✓
Custom Interval			✓
Variety			
Random	✓	✓	✓
1 Cross Country	✓	✓	✓
2 Cross Country		✓	✓
1 Gluteal		✓	✓
2 Gluteal		✓	✓
1 Custom		✓	✓
2 Custom		✓	✓
Heart Rate			
Basic HRC*	✓	✓	✓
Custom Weight Loss HRC*	✓	✓	✓
Weight Loss HRC	✓	✓	✓
Heart Health HRC*			✓
Endurance HRC*			✓
Speed HRC*			✓
Weight Loss			
Custom Weight Loss HRC*	✓	✓	✓
Weight Loss HRC	✓	✓	✓
1 Aerobic	✓	✓	✓
2 Aerobic		✓	✓
Performance			
Track	✓	✓	✓
5 K	✓	✓	✓
Gerkin Fitness Test	✓	✓	✓
USAF PRT		✓	✓
Navy PRT		✓	✓
Army PFT		✓	✓
USMC PFT		✓	✓
Federal Law Enf. PEB		✓	✓

Electronic Readouts

% Complete
Average Heart Rate*
Average Speed
Calories
Calories per Hour
Calories per Minute
Distance
Elevation Gain
Goal
Heart Rate*
Heart Rate Analysis*
Incline
Language
Maximum Heart Rate*
METS
Pace
Profile
Segment Time Remaining
SmartRate*
Speed
Target Heart Rate
Time
Time Elapsed
Time in Heart Rate Zone*
Time Remaining
Units
Watts
Workout Summary

* Use of a chest strap or the touch-sensitive grips is required.



Precor Incorporated
20031 142nd Ave NE
P.O. Box 7202
Woodinville, WA USA 98072-4002

Precor, C, CrossRamp, EFX, M, Move Beyond, and SmartRate are registered trademarks of Precor Incorporated. Crosstrainer, Crosstraining, QuickStart, and StretchTrainer are trademarks of Precor Incorporated.
Copyright 2008 Precor Incorporated.
Specifications subject to change without notice.
www.precor.com

NOTICE:

Precor is widely recognized for its innovative, award winning designs of exercise equipment. Precor aggressively seeks U.S. and foreign patents for both the mechanical construction and the visual aspects of its product design. Any party contemplating the use of Precor's product designs is hereby forewarned that Precor considers the unauthorized appropriation of its proprietary rights to be a very serious matter. Precor will vigorously pursue all unauthorized appropriation of its proprietary rights.



9x6i URM 49004-106, en
03 March 2008

Assembly Guide



946i

PRECOR[®] USA
move beyond[®]

932i
946i

Commercial Treadmills

Thank you for choosing Precor. For proper installation, please read this guide thoroughly and follow the assembly instructions. If you do not assemble the treadmill according to these guidelines, you could void the Precor Limited Warranty.

Obtaining Service

You should not attempt to service the treadmill except for maintenance tasks as described in the *Product Owner's Manual*. If any items are missing, contact your dealer. Should you need more information regarding customer support numbers or a list of Precor authorized service centers, visit the Precor web site at www.precor.com/corp/contact.

Unpacking the Equipment

The unit is shipped in two boxes. Ask for help from two or more people to unpack and assemble the treadmill.

Required Tools

- Crescent wrench
- Wire tie cutter

Cardio Theater PVS Assembly Instructions

If the Cardio Theater Personal Viewing System (PVS) accompanies this Precor unit, review the PVS assembly instructions found in the Cardio Theater box. Alleviate additional assembly or disassembly steps by combining the two assemblies as needed.

Installation Requirements

Follow these installation requirements when assembling the unit:

- **Assemble the unit near the location where you plan to use it.**
- **Provide ample space around the unit.**
The minimum space requirement needed for user safety and proper maintenance is three feet wide by six feet deep (one meter wide by two meters deep), directly behind the running belt.
- **Set up the unit on a solid, flat surface.**
A smooth, flat surface under the unit helps keep it level. A level unit has fewer malfunctions.
- **Open the box and assemble the components in the sequence presented in this guide.**
- **Insert all fasteners with your fingers.**
Use your fingers to properly align and thread the fasteners. This helps alleviate cross-threading. Do not fully wrench tighten fasteners until instructed to do so.

Important: When wrench tightening, the head of the fastener should be flush with the product. If it is not, cross-threading has occurred. Do not attempt to rework the assembly as more damage to the equipment will occur. Contact Customer Support. Refer to Obtaining Service.

Hardware Kit

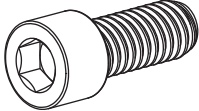
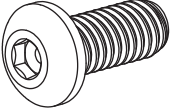
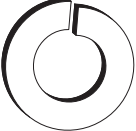
Fasteners		Quantity
	(A) Socket head screw (3/4-inch)	8
	(B) Buttonhead screw (3/4-inch)	6
	(C) Split washer (5/16-inch)	6

Note: Additional fasteners exist in the hardware kit, but they are not used on this product.

1 – 1/4-inch hex key

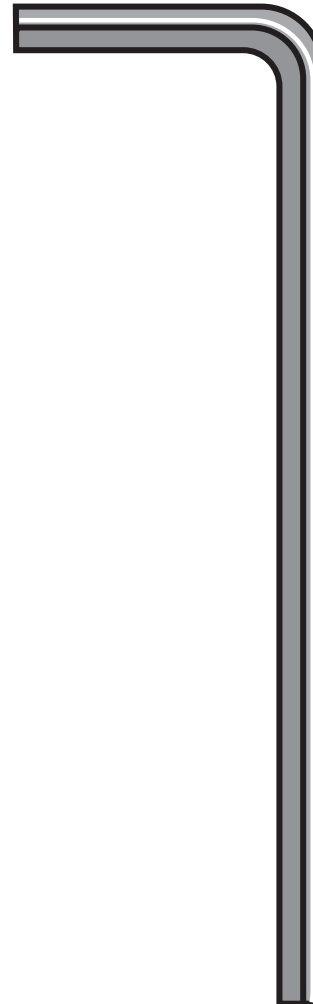

1 – 3/16-inch hex key



Assembly Steps

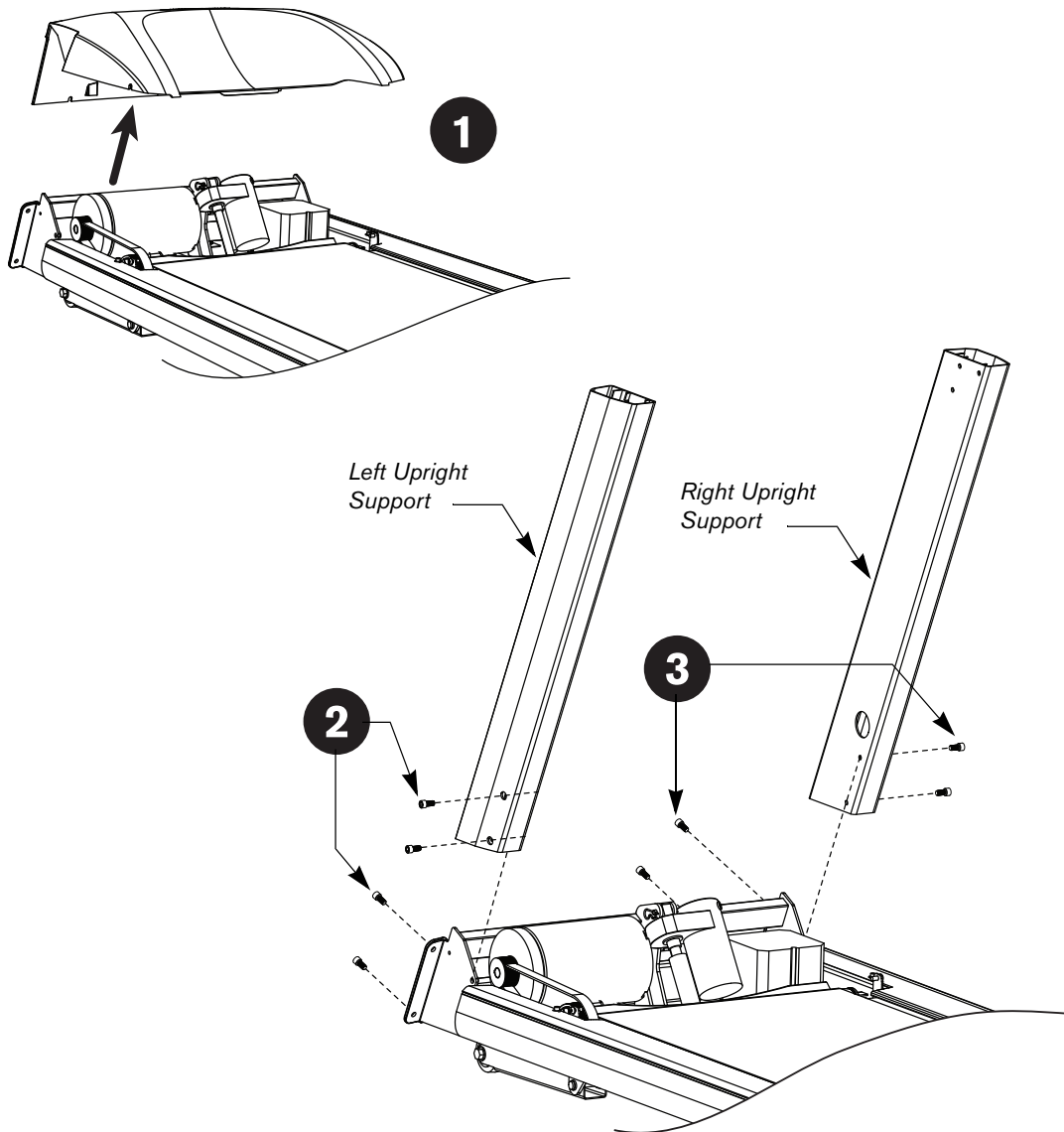

CAUTION: The location of the On/Off switch is beneath the cutout on the base frame. Make sure the power switch is in the Off position. Make sure the power cord is disconnected from its power source.

- 1** Loosen, but do not remove, the two front fasteners and two side fasteners on the hood using the $\frac{3}{16}$ -inch hex key. Remove the hood and set it aside.
- 2** Slide the left upright support into the base frame bracket. Ask your assistant to insert a socket head screw (A) into the top mounting hole on the front of the bracket. Thread the screw so the other mounting holes line up. Then, insert the other three screws (A). To allow room for adjustments, loosely tighten the screws with the $\frac{1}{4}$ -inch hex key.
- 3** Attach the right upright support by following the same procedure as step 2 using four socket head screws (A). To allow room for adjustments, loosely tighten the screws with the $\frac{1}{4}$ -inch hex key.

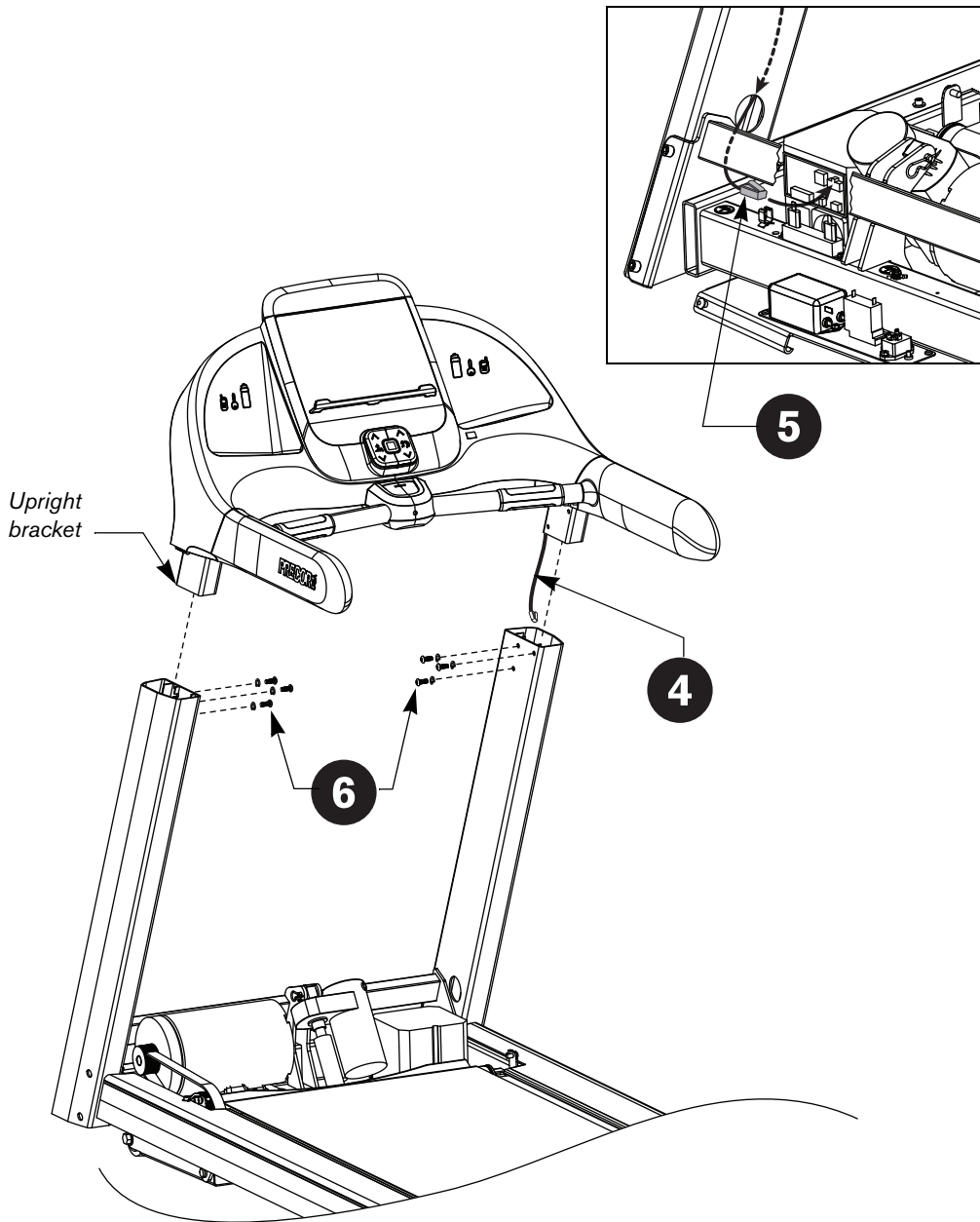

- 4** Ask your assistant to hold the display console above the upright supports while you unwrap the cable and feed the it through the right upright support.

CAUTION: Be aware of the handrail extensions when you are working around the front of the unit. It is easy to bump your head or sustain other injuries if you ignore the location of the handrail extensions.

- 5** Pull the cable out through the grommeted hole and connect the cable to its receptacle on the electronics board. The tab on the cable connector faces the front of the treadmill. An audible click is heard when the cable is properly attached.

Important: Make sure the upright bracket and fasteners do not pinch the cable. Cables damaged by improper installation will not be covered by the Precor Limited Warranty.

- 6** Lower the display console. Avoid pinching the cable by placing it along the front edge of the upright bracket. Align the mounting holes and insert six buttonhead screws (B) and six split washers (C). Loosely tighten the screws with the $\frac{3}{16}$ -inch hex key to allow room for adjustments.

Important: Do not wrench tighten the screws until the unit has been fully assembled. Make sure the fasteners do not pinch the cable. Cables damaged by improper installation will not be covered by the Precor Limited Warranty.

7 Tighten all mounting screws.

1. Start at the base and alternately tighten the eight fasteners that secure the upright supports to the base assembly.
2. Wrench tighten the six screws that secure the display console to the upright supports.

CAUTION: Be aware of the handrail extensions when you are working around the front of the unit. It is easy to bump your head or sustain other injuries if you ignore the location of the handrail extensions.

8 Position the hood over the running belt so you can slide it through the upright supports from the rear. Align the hood with its four fasteners. Use the $\frac{3}{16}$ -inch hex key to wrench tighten the two side fasteners before wrench tightening the two fasteners that secure the front of the hood.

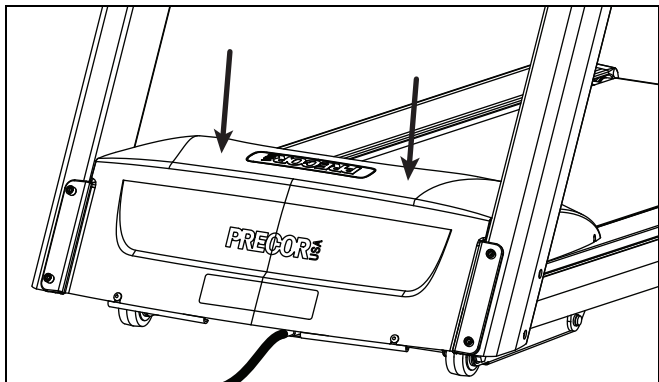

9 Before using the unit, make sure it is level. If adjustments are needed, adjust one rear foot at a time. Do not raise the unit more than $\frac{3}{4}$ inch (2 cm) from the floor.

1. Ask a capable assistant to lift the rear portion of the treadmill (using proper lifting techniques).
2. Loosen the upper lock nut with a crescent wrench and rotate the rear feet as needed.

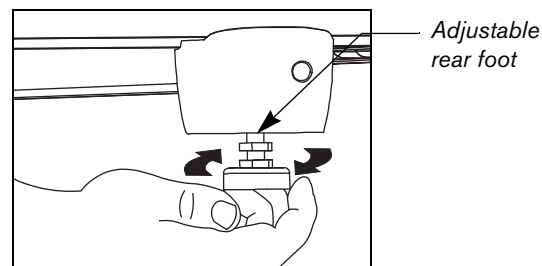

3. Retighten the lock nut and lower the treadmill to the floor.

10 Plug the power cord into an appropriate outlet.

Important: The treadmill requires a dedicated, grounded circuit. A 20-amp circuit is recommended. Refer to Grounding Instructions in the Product Owner's Manual.

11 Check the alignment and adjust the running belt. For instructions, refer to *Checking the Alignment and Adjusting the Running Belt*. If you wish to test the heart rate feature, refer to the owner's manual.

12

Checking the Alignment and Adjusting the Running Belt

Proper belt alignment allows the belt to remain centered and ensures smooth operation. Realigning the belt takes a few simple adjustments. If you are unsure about this procedure, contact Precor Customer Support. Refer to *Obtaining Service*.

To check the alignment:

CAUTION: Special care must be taken when aligning the running belt. Turn Off the treadmill while adjusting or working near the rear roller. Remove any loose clothing and tie back your hair. Be very careful to keep your fingers and any other object clear of the belt and rollers, especially in front of the roller and behind the deck. The treadmill will not stop immediately if an object becomes caught in the belt or rollers.

1. Turn the unit On.
2. Stand beside the treadmill and press QUICKSTART.
The running belt starts automatically after a 3-second countdown appears on the display.
3. Press the SPEED up arrow key until the display shows a speed of 3 mph (5 kph).

CAUTION: If you hear any chafing or the running belt appears to be getting damaged, stop the running belt immediately by pressing the red STOP button. Contact Precor Customer Support.

4. Walk around to the rear of the unit and observe the belt for a few minutes. The belt should run centered along the running bed. If the belt drifts off center, you must make adjustments. Refer to *Adjusting the Running Belt*.

Important: *If the belt needs alignment, make the adjustments at once. Failure to align the belt may cause the belt to tear or fray, which is not covered by the Precor Limited Warranty.*

5. To stop the running belt, press the red STOP button.
6. Turn the treadmill Off.

To adjust the running belt:

If you are unsure about adjusting the running belt, contact Precor Customer Support. Refer to *Obtaining Service*.

CAUTION: For your safety, use the power switch to turn Off the treadmill before making any adjustments. Do not adjust the running belt when someone is standing on the unit.

1. Locate the right belt adjustment bolt in the rear end cap of the treadmill.

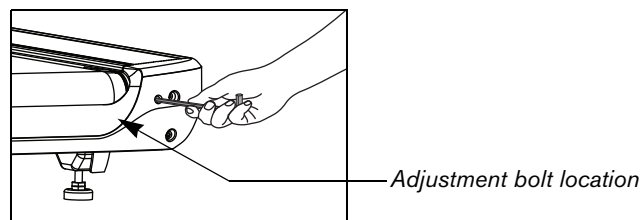

To determine left and right, stand at the rear of the treadmill and face the display. Make all belt adjustments on the **right rear corner bolt** using the 1/4-inch hex key.

- If the belt is off center to the LEFT, turn the adjusting bolt 1/4 turn *counterclockwise*, which moves the running belt to the right.
- If the belt is off center to the RIGHT, turn the bolt 1/4 turn *clockwise*, which moves the belt to the left.

Important: *Do not turn the adjusting bolt more than 1/4 turn at a time. Overtightening the bolt can damage the treadmill.*

2. Recheck the alignment of the running belt.

Notes:

Notes:

PRECOR[®]USA
move beyond[®]

Precor Incorporated
20031 142nd Avenue NE
P.O. Box 7202
Woodinville, WA USA 98072-4002



©2008 Precor Incorporated
www.precor.com
946i/932i AG 49921-102, en
11 February 2008