

Octane[®]

F I T N E S S

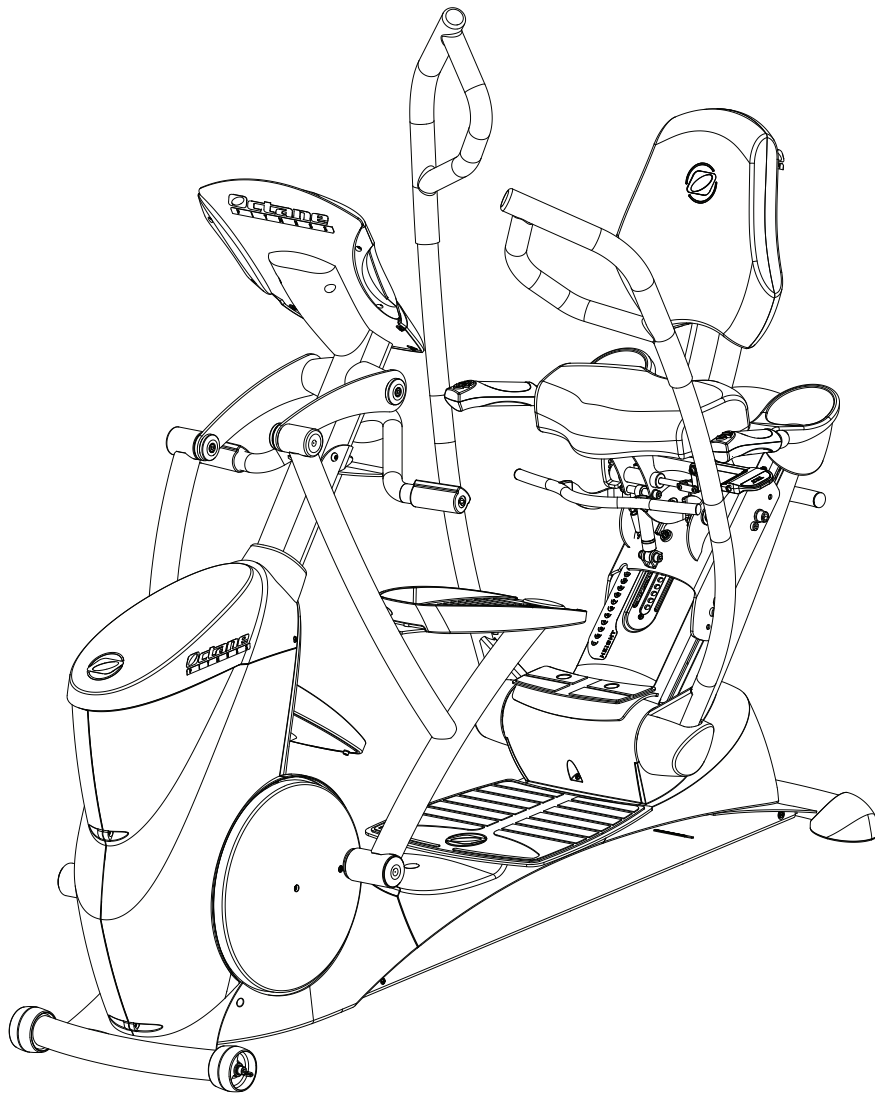

xRide[™]

xR6000

OPERATIONS MANUAL

This product is intended for commercial use.

PLEASE READ AND SAVE THESE INSTRUCTIONS

IMPORTANT SAFETY INSTRUCTIONS

WARNING! Anyone using this product should consult a physician before they start their exercise program. This is especially important for persons over 35 or those with pre-existing health conditions. If at any time during their workout exercisers experience chest pains, nausea, dizziness, or shortness of breath, they should stop exercising immediately and consult their physician before starting again.

Have all club, personal training, and sales staff members review this Operations Manual before operating this seated elliptical cross trainer. Also, make this Operations Manual accessible to all exercisers.

WARNING! When using an electrical product, basic precautions should always be followed.

To reduce the risk of burns, fire, electrical shock, or injury to persons:

- Use this exercise product for its intended use as described in this Operations Manual. **Do not** modify the product in any way.
- **Do not** remove the plastic shrouds from the machine. Service should be performed only by an authorized Octane Fitness service representative. Moving parts contained under the shrouds can be extremely dangerous when not covered.
- **Never** operate this seated elliptical cross trainer if it has a damaged wire or plug, if it is not working properly, if it has been dropped or damaged, or dropped in water. Return the cross trainer to your local dealer or Octane Fitness for examination and repair.
- **Never** operate this seated elliptical cross trainer with the air openings blocked. Keep the air openings free of lint, hair, and the like.
- **Do not** use outdoors.
- **Do not** operate this seated elliptical cross trainer where aerosol (spray) products are being used or where oxygen is being administered.
- **Do not** mount an LCD screen weighing more than 8.5 lbs. (3.8 kg) on the optional LCD mounting arm.

SAVE THESE INSTRUCTIONS

OTHER IMPORTANT SAFETY PRECAUTIONS

- Place the seated elliptical cross trainer on a level surface with at least 12 inches (30.5 cm) of clearance on each side of the unit.
- To protect the floor or carpet from damage, place a mat under your seated elliptical cross trainer.
- Keep children off the seated elliptical cross trainer at all times.
- When the seated elliptical cross trainer is in use, children and pets should be kept clear of the area.
- Wear appropriate exercise clothing and shoes for your workout—do not wear loose clothing.
- Use care when getting on or off the seated elliptical cross trainer. Never get on or off the unit while the foot pedals and arms are still moving.
- When adjusting seat height or tilt, make sure you hear and feel the adjustment mechanism lock into position.
- Always face forward. Never attempt to turn around on the seated elliptical cross trainer.
- Do not sit, stand, or climb on the plastic shrouds, electronic console, or stationary foot pegs.
- Keep your hands and feet clear of any opening or moving parts.
- Keep your feet within the boundaries of the foot pedals; do not rest toes or any other part of the foot on the edges of the pedals.
- Never insert or drop any object into any opening.
- Do not overexert yourself or work to exhaustion.
- If during your workout you feel any chest pain, nausea, dizziness, or abnormal symptoms, stop your workout immediately and consult your physician.
- Wipe down external surfaces of your cross trainer after use to remove sweat and dust.
- Monitor and check your seated elliptical cross trainer regularly. If service is required, contact your local dealer or Octane Fitness Customer Service for assistance.
- Take caution in moving your seated elliptical cross trainer. Your elliptical weighs over 300 lbs. Use proper lifting techniques and/or get assistance when moving your product.

Product Dimensions: 1803mm x 889mm x 1439mm
(71 in x 35 in x 57 in)

Product Weight 320 lbs. (145 Kg)
Max User Weight 400 pounds (181 Kg)

Power Supply/Electrical Specifications:
This is a self-powered machine.

This equipment complies where applicable with:

2006/95/EC	Low Voltage Directive
2004/108/EC	Electromagnetic Compatibility (EN61000)
2002/95/EC	Restriction of Hazardous Substances (RoHS) Directive
2006/96/EC	WEEE Directive
EN957-9:2003	Stationary training equipment
EN957-1:2005	Stationary training equipment
EN60335-1:2002	Household and similar electrical appliances - Safety
GPS	General Product Safety Regulations 2005

This device complies with part 15 of the FCC Rules. Operation is subject to the following two conditions: (1) This device may not cause harmful interference, and (2) this device must accept any interference received, including interference that may cause undesired operation.



HEART RATE SAFETY GUIDELINES

Before using the Octane Fitness xR6000 with HeartLogic™ Intelligence, read and follow these instructions:

Contact Heart Rate Grips

- Clean the contact heart rate grips periodically to remove sweat and oils. Use a damp cloth with a mild detergent. Do not spray the hand grips directly with water or a cleaner; this could cause an electrical short.
- For the most accurate heart rate reading possible, wrap your hands around each contact heart rate grip so that the palm of your hand and your fingers make contact with the metal sensors on the top and bottom of the grip. Grasp firmly, and keep your hands steady and in place.

Wireless Chest Strap

- Exercisers may use any Polar™-compatible (coded or non-coded) wireless heart rate transmitter with the Octane Fitness xR6000.
- **Do not allow users to use the chest strap if they have a cardiac pacemaker or are taking prescription medication.** Medication or electrical impulses from the cardiac pacemaker can cause inaccurate heart rate readings.
- Please take care in handling the equipment as it is extremely sensitive.
- Do not bend the strips inside the chest strap as it can cause the strap to lose its conductivity.
- Handle the heart rate transmitter (chest strap) with care. Dropping the transmitter might cause damage and this could void the warranty.
- If the receiver (console) tries to process several signals simultaneously, an incorrect heart rate reading could result. In a commercial setting, space the products at least 24" apart. This will prevent cross-talk, where the chest strap signal from a user on one machine can be received and displayed on the console of another machine.
- Do not place the chest strap near devices that generate large magnetic fields. Television sets, electric motors, radios, and high voltage power lines can affect the transmitter's performance. These items can interfere with the heart rate signal that is being transmitted to the receiver, possibly affecting the heart rate readings that appear on the electronic console.
- Do not immerse the transmitter in water. However, some moisture is necessary for the transmitter to function properly. Perspiration is usually sufficient, but you may need to moisten the electrodes with a small amount of water. The electrodes are the ribbed portion on the side of the transmitter that sits against your skin.
- The wireless chest strap has a battery which may need to be replaced from time to time. A faulty battery or worn electrodes may cause inaccurate readings. The electrodes are the ribbed portion on the side of the transmitter that sits against your skin.
- To purchase wireless transmitter straps, contact your dealer or Octane Fitness sales representative.

Some individuals are unable to use the heart rate feature because they do not have the proper body chemistry to provide accurate readings. If you experience difficulties in using the contact heart rate grips or a wireless chest strap, contact your dealer or Octane Fitness Customer Service at 1.888.OCTANE4.

WARNING! The heart rate monitoring features of this product are for information only and are **not** to be used as a measure of heart functioning or heart health. In a heart rate controlled program, the exerciser can use the Level controls to reduce the resistance level at any time. **Each exerciser is responsible for monitoring how he or she feels and adjusting the level of effort accordingly.** If at any time during exercise a user experience chest pains, nausea, dizziness, or shortness of breath, he or she should stop exercising immediately and consult a physician before starting again.

xR6000 PRODUCT LABELS

WARNING

Before starting any exercise program, consult your physician. Machine contains moving parts. To avoid injury keep children and pets clear of the exerciser at all times. Review and follow all warnings and instructions in the owner's manual prior to use.

WARNUNG

Bevor Sie mit diesem Übungsprogramm beginnen, sollten Sie Ihren Arzt um Rat fragen. Maschine enthält bewegliche Teile. Um Verletzung zu vermeiden halten Sie Ihre Kinder und Haustiere durchgehend von der Maschine entfernt. Lesen und befolgen Sie alle Warnungen und Anweisungen in der Bedienungsanleitung vor Gebrauch.

DEU

AVERTISSEMENT

Avant d'entamer un programme d'exercice, veuillez consulter votre médecin. L'appareil possède des parties mobiles. Pour éviter un accident, les enfants et les animaux domestiques doivent toujours être tenus à l'écart de la machine d'exercice. Avant de vous servir de votre appareil, lisez et suivez tout avertissement et toutes consignes dans le manuel d'utilisateur.

FR-C

CAUTION

Moving parts. Keep children, pets, hands and feet clear during use.

VORSICHT

Bewegliche Teile. Kinder, Haustiere, Hände und Füße während des Gebrauchs entfernt halten.

DEU

ATTENTION

Pièces mobiles. Gardez à l'écart les enfants, les animaux domestiques, les mains et les pieds pendant l'utilisation.

FR-C

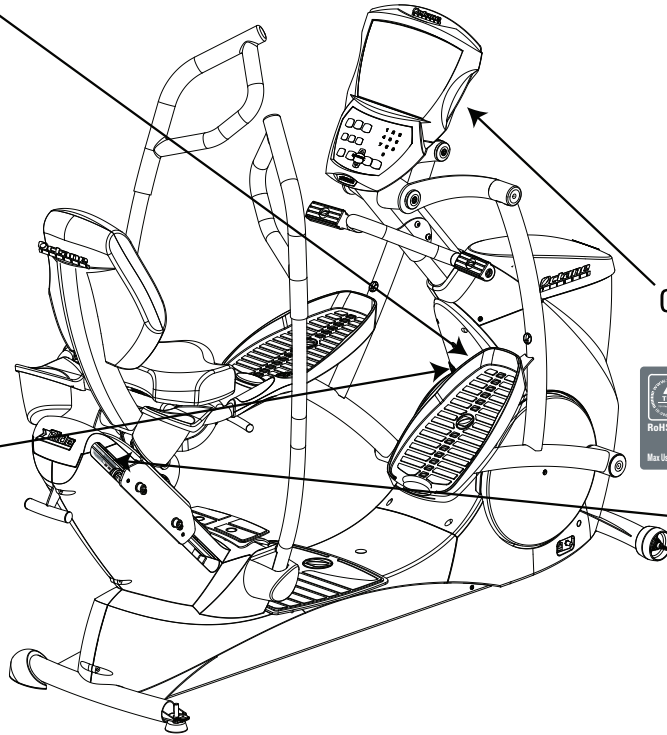

Console Serial Number
(remove back cover to view)



Base Serial Number

TABLE OF CONTENTS

Getting Started	1
• Adjusting the Seat	1
• User Set-Up Functions	1
• Cleaning and Maintenance of the xR6000	2
• Troubleshooting & FAQs	2
• Warranty Information	2
Electronics	3
• xR6000 Console & Keypad	4
• Console Windows	7
xR6000 Programs	9
• How Does Workload Resistance (Level) Work?	9
• xR6000 Program Reference	11
xR6000 Product Features	15
• HeartLogic Intelligence	15
• MultiGrip Handlebars	16
• Fingertip Controls	16

GETTING STARTED

Welcome to a new breed of exercise equipment— xRide™ by Octane Fitness! You will soon be experiencing a great ride as you challenge yourself with its sophisticated electronics and the variety of pre-programmed workouts. Getting started is easy; just move one of the moving handlebars toward the back of the unit and have a seat. Check out the program descriptions on page 11, and you are on your way!

Adjusting the Seat

The comfort and effectiveness of the workout on the xR6000 begins with proper seat position. Both the height of the seat and the tilt of the seat back on the xR6000 seat are adjustable, ensuring that you can find just the right position to suit your preference and deliver the best possible workout.

Note: *When adjusting seat height or tilt, make sure you hear and feel the adjustment mechanism lock into position.*

Adjusting seat height

Adjust seat height on the xR6000 Series using the handle located just under the front edge of the seat. While bracing yourself with your feet on the platform, lift up on the handle and use your legs to move the seat into a comfortable height. Place your feet on the pedals and pedal forward, stopping when one pedal is at its lowest point. Check the position of your leg on this pedal; your knee should be slightly bent. If your leg is fully extended, or your knee is bent too much, readjust the seat height until you have the proper leg extension.

Adjusting seat back tilt

Adjust the tilt of the seat back on the xR6000 Series using the handle located just under the left edge of the seat. You may choose one of five positions, with position 1 being the most upright and position 5 being the most reclined. To adjust, lift up on the yellow handle to disengage the tilt lock. Press back to recline or shift your weight slightly forward to tilt the seat back up. Release the handle, then shift your weight slightly until you hear the tilt lock pop into position.

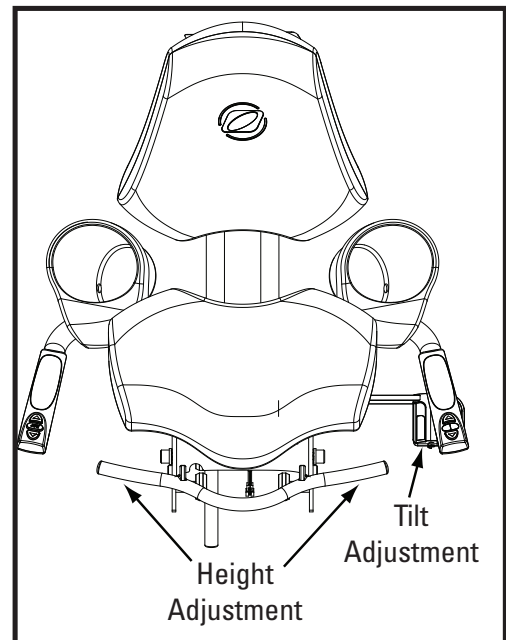

Note: *Once you have adjusted the tilt of the seat back to a comfortable position, pedal forward and recheck your leg extension. You may need to readjust the seat height to compensate for the change in tilt.*

Tip: *Be sure to record the position numbers of both the seat height (1-20) and the seat back tilt (1-5) so that you can quickly set the seat when you are ready to begin your next workout.*

User Set-Up Functions

Many standard features and controls of the xR6000 can be customized to fit personal preferences or the workout environment. These adjustments are easily completed and are saved as the new standard for the machine—you don't need to reset them for each use.

To access the User Set-up functions, press and hold both the Up Arrow (▲) and Down Arrow (▼) keys for three seconds, or until you hear a beep. The customizable functions are displayed in sequence in the Message Center; use the Enter key to toggle through the available options (shown in the matrix display) for each function, and press the Up Arrow (▲) or Down Arrow (▼) key to select a setting and move to the next function. To exit without changing any values, press Pause Clear twice.

Warm-Up	This feature may be turned "ON" (to include a 3-minute warm-up in each workout) or "OFF". The factory default setting is "ON".
Clock Direction	Track workout time by counting "UP" or "DOWN". The factory default setting is "UP".
Max Workout Time	Set the maximum workout time to any 1-minute increment between 1:00 and 99:00. Use the Enter key to scroll through the possible values, and press the Up Arrow (▲) or Down Arrow (▼) key to select the desired value. The factory default setting is 30 minutes.
Unit Type	Display weight and distance units in "ENGLISH" (pounds and miles) or "METRIC" (kilograms and kilometers). The factory default setting is "ENGLISH".
Beep	Turn the console sounds "ON" or "OFF". The factory default setting is "ON".
Brightness	Adjust the intensity or brightness of the console LEDs, choosing any value between 1 and 8. The factory default is 8, the brightest setting.
Exit	When EXIT is displayed in the Message Center, press Enter to leave User Set-up. All selections will be saved and become the new standard settings for the machine.

Two additional button sequences may be useful in your setting:

Machine Hours	Press and hold Up Arrow (▲), Program, and Level for three seconds to see the total machine usage, in hours, since the last reset.
New Leaf Assessment	Press and hold Program and Time for three seconds to access the New Leaf Assessment program if you are working with New Leaf Fitness professionals in this area.

Cleaning and Maintenance of the xR6000

WARNING! This machine contains moving parts. Take caution when trying to locate and fix any problem with the machine.

Your Octane Fitness seated elliptical has been manufactured to withstand many hours of hard use with minimal required maintenance. Simply wipe off the machine after a hard workout to remove any sweat to keep the machine clean.

Please contact your local Octane Fitness dealer should you have any questions or encounter any maintenance issues with your xR6000. If you would like to speak directly to an Octane Fitness customer service specialist, please call 888.OCTANE4 or visit www.octanefitness.com.

Troubleshooting & Frequently Asked Questions

Should you have any questions regarding your xR6000 seated elliptical, please log on to www.octanefitness.com where you will find answers to many common questions and tips on using your elliptical. If you would like to speak to an Octane Fitness Customer Service specialist, please call 1-888-OCTANE4 or 763-757-2662 extension 1.

Warranty Information

The xR6000 seated elliptical is warranted to be free of all defects in material and workmanship. All parts are warranted for three (3) years from original date of purchase. Labor is covered for one (1) year from original date of purchase. This warranty is nontransferable.

Please refer to the Octane Fitness Limited Commercial Warranty and/or the Octane Fitness Limited Consumer Warranty included in your information packet for full details of warranty coverage.

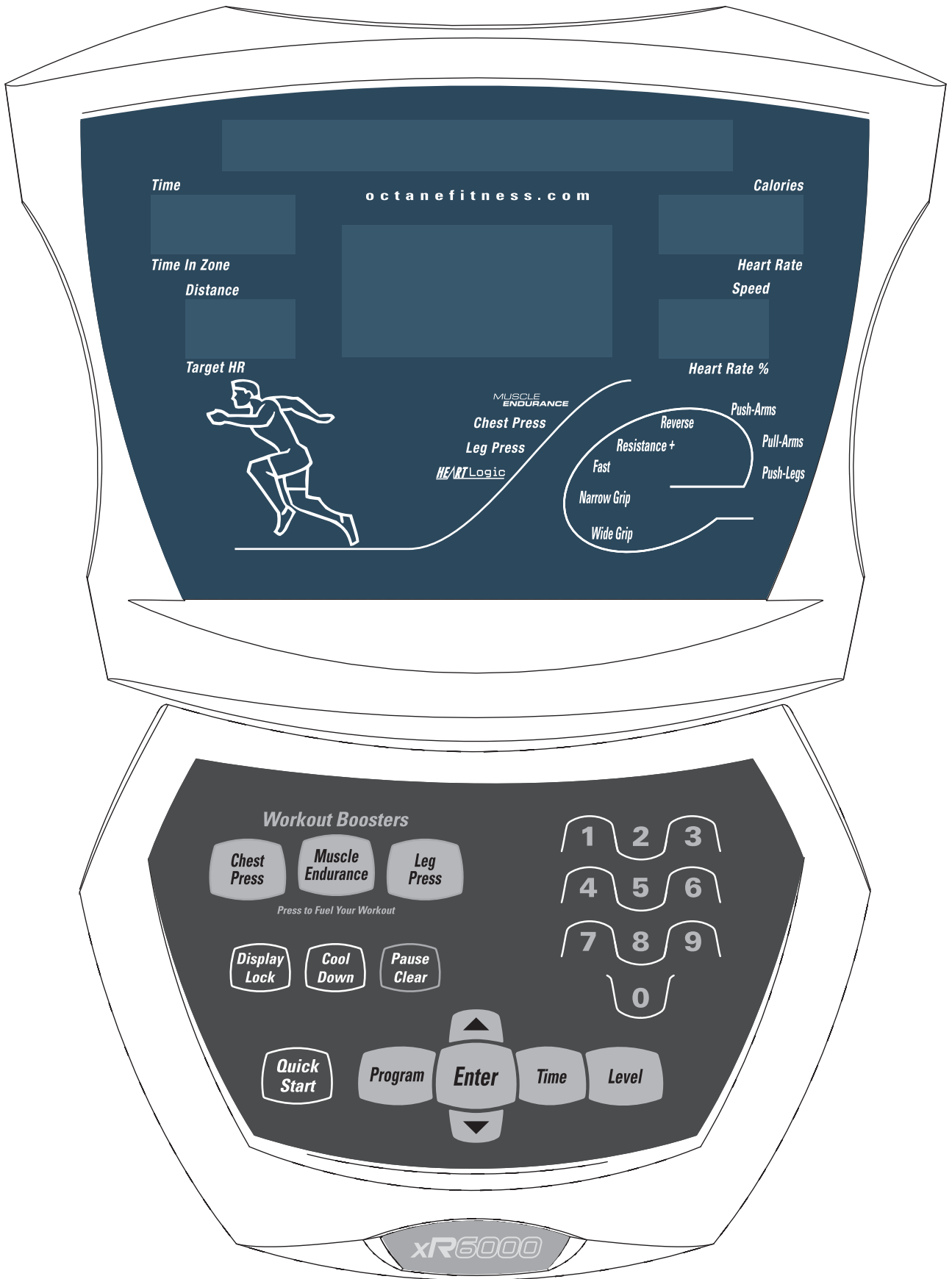

ELECTRONICS

xR6000 Console and Keypad

Welcome to some of the easiest to use, yet most sophisticated, electronics available in the fitness industry! The XR6000 features a simple, easy to understand keypad and a console featuring an informative Message Center, a workout profile matrix, and four multi-function LED display windows that provide all the information needed to get started and stay motivated during workouts.

Console Programming

DedicatedLogic™ programming was created for the ultimate in ease of use and total flexibility for programming the console, allowing you to modify your workout once you've started. This ease of use starts by giving each key only one function, making it easy to understand how each key works.

Getting started is easy—just hop on, adjust the seat, and start pedaling or press any key. The Message Center prompts you to select a program. The console display guides you through the steps to program the workout. Simply enter the requested data and press Enter. If no values are entered at the prompts, the machine defaults to the standard values for the program you have selected.

CSAFE Interface

The XR6000 is compatible with CSAFE (Communications Specifications for Fitness Equipment) protocol. If you have connected the XR6000 to your CSAFE network, the user is prompted to enter a 5-digit User ID. The CSAFE user has 30 seconds to enter the User ID digits using the numeric keypad. Once the ID has been entered, the display proceeds with prompting the user for program set-up. If no User ID or program is entered, the machine defaults to the manual program at resistance level 1 and a user weight of 150 pounds (68 kg).

Keypad Buttons

Quick Start

The easiest way to start a workout is to simply push the Quick Start button, setting the machine in a manual program at resistance level 1, age 40 and weight 150 pounds (68 kg). Then use the keys to set Program, Time or Level, in any order.

Display Lock

Press the Display Lock button to stop the display LEDs from toggling between the top and bottom (heart rate) display values in the windows. Press Display Lock a second time to resume toggling.

Cool Down

It is a good idea to cool-down at the end of your routine to transition your body from an aggressive workout to its normal pace. The time and intensity of the cool-down is automatically customized to your workout duration and resistance level. The time window displays a countdown timer to tell you how long the cool-down will last.

The cool-down will automatically start when time has expired. If you decide to end your workout early, simply push the Cool Down button to activate the custom cool-down.

Pause Clear

To pause your workout, press the Pause Clear button once or simply quit pedaling. The matrix display will indicate how long the pause will last before you need to resume pedaling. Typically this is two minutes; however, if the unit's battery is not fully charged, the pause time is 10 seconds. Your workout settings and statistics will be saved for the duration of the pause. To restart a paused workout, push any key or start pedaling before the pause countdown reaches zero.

To reset the machine for another workout, press the Pause Clear button twice within two seconds.

Program Press Program, then use the Up Arrow (▲) or Down Arrow (▼) key to toggle through programs. Program changes can be made any time during a workout. When changing programs, the Message Center prompts you to enter new program values as needed.

Up Arrow (▲) Use this key during set-up to increase the value of the parameter highlighted in the Message Center, including program, time, level, target heart rate, watts or METs, number of intervals, age, or weight. During a workout, pressing the Up Arrow (▲) key increases the resistance level, target heart rate, or constant output target, depending upon the program.

Down Arrow (▼) Use this key during set-up to decrease the value of the parameter highlighted in the Message Center, including program, time, level, target heart rate, watts or METs, number of intervals, age, or weight. During a workout, pressing the Down Arrow (▼) key decreases the resistance level, target heart rate, or constant output target, depending upon the program.

***Tip:** The Up Arrow (▲), Down Arrow (▼), and Enter buttons on the right stationary handlebar may be used instead of the keypad buttons to scroll through selections and make entries at any time during set-up or a workout.*

Enter Selects any of the changed values or items from the other keys.

Time Press Time, then use the Up Arrow (▲) or Down Arrow (▼) key to increase or decrease the time of your workout, in 1 minute increments. The standard workout time is 30:00. The maximum time is 99:00. The standard value can be changed using the User Set-up Functions as described on page 1.

Level Press Level to increase the resistance level of the machine. There are 30 levels of resistance for preset resistance programs and the 30:30 fitness number program. For heart rate controlled programs, the Level button increases target heart rate. For the constant power programs, the Level button increases target watts or METs.

Workout Boosters

Chest Press Press this button to activate a unique workout booster designed to build endurance, strength and muscle tone in your upper body. Chest Press integrates cardio sessions with strength sessions focused on the chest, arms, and back. The cardio session follows the selected program profile. For each Chest Press interval, the resistance level increases 6 levels (or to the maximum resistance of 30) for a muscle-building, 10-repetition set as you place your feet on the stationary foot pegs and transfer the workload from lower body to upper body. During the Chest Press set, the level of resistance can be changed by pressing the Level (▲/▼) buttons. Deactivate Chest Press by pressing the button a second time.

Leg Press Push Leg Press to activate an aggressive routine to help you build strength and power in your leg muscles. Leg Press integrates cardio sessions with strength sessions focused on the legs. The cardio session follows the selected program profile. For each Leg Press interval, resistance increases 8 levels (or to the maximum resistance of 30) for a muscle-building, 15-repetition set as you place your hands on the stationary handlebars and transfer the workload to the lower body. During the Leg Press set, the level of resistance can be changed by pressing the Level (▲/▼) buttons. Press this button a second time to deactivate.

Muscle Endurance

Press Muscle Endurance to activate the ultimate cross training tool and take advantage of the variety your seated elliptical cross trainer offers. This great motivational tool keeps your workout fresh and exciting in any program. Every other minute it kicks in, increasing your current resistance level by 4 and prompting you to perform combinations of eight different challenges:

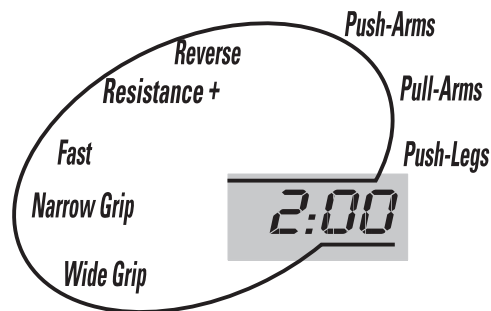

- Push-Legs** Focus on pushing with your legs to work your quadriceps and glutes.
- Pull-Arms** Focus on pulling with your arms to work your biceps and lats.
- Push-Arms** Focus on pushing with your arms to work your chest and triceps.
- Reverse** Pedal backwards to change the muscle focus in your legs.
- Fast** Pick up the pace—we recommend 60+ rpm, but you should find your own comfort level.
- Resistance⁺** Sweat it out as you work your entire body with a quick burst at 3 additional levels of resistance—a total of 7 levels higher than your program resistance level!
- Narrow Grip** Grasp the multigrips on the low inside edge to give your triceps and chest muscles a workout.
- Wide Grip** Grasp the multigrips high on the outside and feel it in your shoulders, chest, and back.

Deactivate Muscle Endurance by pressing the button a second time.

Tip: Boost your workout to a new level by activating both Leg Press and Chest Press at the same time, alternating strength sets between the upper and lower body with a recovery period in between. A great challenge and a great workout!

Console Windows

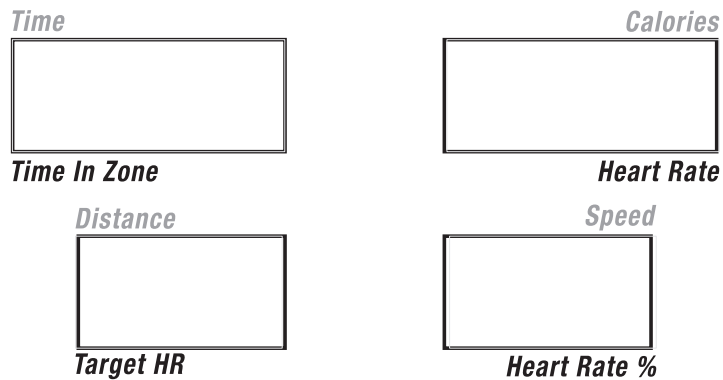

Message Center

The XR6000 Message Center features a scrolling LED display which prompts you to enter important information, guides and motivates you through your workout, and rewards you with clear, relevant workout data such as level, average speed, average heart rate, maximum heart rate, calorie/hour, watts, and METs. Watch the message center as you set up and progress through your workout—it will guide you, motivate you, and reward you with summary information at the end of your session.

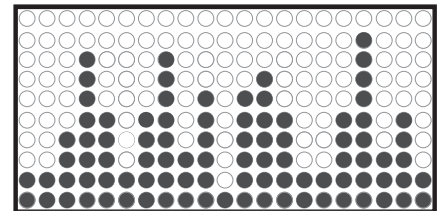

Matrix Display

The matrix display shows the program profile during the workout and highlights upcoming intervals and resistance changes. During heart rate interval programs (Heart Rate Interval, Heart Rate Hill, Heart Rate Speed Interval, Heart Rate Custom Interval, New Leaf Custom), the matrix display is used to inform you of your progress through the intervals:

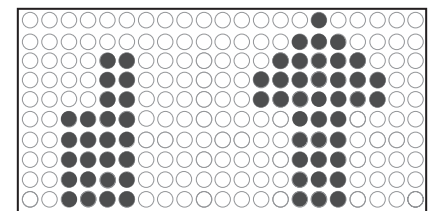

Upcoming columns blink

Changing Target Heart Rates: When you are trying to reach a new target heart rate, the left side of the matrix display shows an illustration of the interval. The illustration blinks the interval you are attempting to reach. Each column represents one minute. An arrow on the right side of the display shows whether resistance (and therefore your target heart rate) is increasing or decreasing. When decreasing, if the machine reaches resistance level 1 and your heart rate has still not reached your target low, the display prompts you with the message "HR TOO HIGH—SLOW DOWN". When

increasing, if the machine reaches the highest resistance level (30) and your heart rate has still not reached your target high, the display prompts you to "INCREASE SPEED TO DECREASE RESISTANCE".

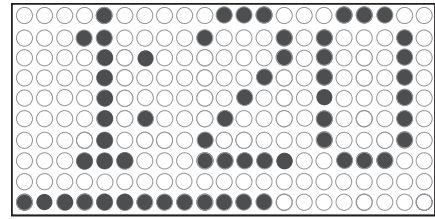

Interval Duration: Once you have reached or surpassed the new target heart rate, the matrix display switches to a countdown timer, counting down the length of the interval. The bottom row of the matrix displays a horizontal bar graph representing the current resistance level.

- Time** Displays workout time, counting up from 0:00. Time can be increased or decreased during your workout. The maximum time that users can set is 99:00. When actual workout time is displayed, the timer goes up to 99:59, then rolls over to 0:00. Refer to User Set-up Features to learn how to switch from a "count up" to "count down" display.
- Distance** Displays an estimate of how far you have traveled. Distance can be shown in either miles (English) or kilometers (metric). On the xR6000, 400 revolutions is approximately one mile; therefore, if you are pedaling at 50 rpm, you will "travel" approximately one mile in 8 minutes. When you first purchase your elliptical the display will be in English. Refer to User Set-up Features to learn how to switch from English to metric.
- Speed** Displays how fast you are going, in revolutions per minute (rpm).
- Calories** Displays an estimate of the total calories burned during the workout, based on the user's entered weight. If no specific weight is entered, calories are based on a 150 lb. (68 kg) user.
- Calories/Hour** Displays the number of calories that would be burned in one hour at the current resistance level and speed.
- Time-in-Zone** Tracks and displays the amount of time spent in the proper heart rate training zone for the program. Time-in-Zone is only displayed in a heart rate controlled program when a heart rate is detected by the machine. A user must be wearing a wireless heart rate transmitter or grasping the contact heart rate sensor grips on the stationary handlebars.
- Heart Rate** Displays heart rate in beats per minute (BPM). A user must be wearing a wireless heart rate transmitter or grasping the contact heart rate sensor grips on the stationary handlebars.
- Heart Rate %** Displays your current heart rate percentage (current heart rate / theoretical maximum heart rate). A user must be wearing a wireless heart rate transmitter or grasping the contact heart rate sensor grips on the stationary handlebars and have entered an age.
- Target HR** Displays the heart rate reading that the machine is adjusting resistance to achieve when in a heart rate controlled program.
- Level** Displays the resistance level (1- 30), where 1 is the lowest resistance level and 30 is the highest.

xR6000 PROGRAMS

The xR6000 features 16 built-in programs to keep workouts interesting:

Preset resistance programs:	Manual—Random—Interval—Custom Interval—Hill—10K
Heart rate controlled programs:	Fat Burn—Cardio—Heart Rate Interval—Heart Rate Custom Interval—New Leaf Custom—Heart Rate Hill—Heart Rate Speed Interval
Constant power programs:	Constant Watts—Constant METs
Fitness program:	30-30

Programs begin with a warm-up to ease the body into the workout. During the warm-up, the resistance increases each minute.

Preset resistance, constant power, and fitness programs incorporate a three-minute warm-up during which resistance increases two levels per minute. Heart rate controlled programs include a warm-up which lasts three minutes or until you reach your target heart rate; then your selected program begins. Increasing or decreasing the Level changes the target heart rate.

How Does Workload Resistance (Level) Work?

Resistance Level

The xR6000 has 30 discrete levels of resistance. Level 1 is the easiest and level 30 is the most difficult. The Manual program and Quick Start give the user the ability to totally control the resistance level. Interval Programs (Interval, Custom Interval, and 30-30) allow the user to select the resistance level for specific intervals.

The resistance level is represented by rows of LEDs in the matrix display. Each row that is lit represents 3 resistance levels. The table below will help you understand and interpret the matrix display:

Resistance Levels	LED Rows Lit	Resistance Levels	LED Rows Lit
1-3	1	16-18	6
4-6	2	19-21	7
7-9	3	22-24	8
10-12	4	25-27	9
13-15	5	28-30	10

Program Level

The Octane Fitness Random, Hill, and 10K programs allow the user to select an overall resistance level for the program. This level is the average resistance level for the workout. The range of resistance levels during these workouts are ± 4 of the entered program level (i.e., For program Level 5, minimum resistance is Level 1 and maximum resistance is Level 9). During the workout, the overall program resistance level is displayed on the console.

**Resistance in
“Constant” Programs**

The Constant Watts and Constant METs programs allow the user to enter the power output level, in watts or METs, for the program. The resistance level during these constant workouts is controlled by the machine, increasing or decreasing as necessary in tandem with the user’s speed to keep the output on target.

**Resistance in Heart
Rate Controlled
Programs**

These programs (Fat Burn, Cardio, Heart Rate Interval, Heart Rate Custom Interval, New Leaf Custom, Heart Rate Hill, and Heart Rate Speed Interval) allow the user to manually enter the target heart rate level for program. If the target HR is reached during the warm-up, the warm-up ends and the selected heart rate control program begins. The resistance level during the heart rate controlled workout is controlled by the machine, increasing or decreasing as necessary to keep the user’s heart rate on target.





Exercisers choose the program that best fits their workout needs for any given day. They can decide how hard to work by setting the resistance level and time for each program. Four programs—Manual, Custom Interval, Custom Heart Rate Interval, and New Leaf Custom—provide even more flexibility to program individual workouts to meet specific needs.

Use the quick-reference chart on the following pages to help select and set up the programs, or read on for more detailed descriptions.

Note: *The xR6000 also includes a fitness assessment program to be used as part of an Active Metabolic Assessment conducted by a certified New Leaf Fitness fitness consultant. To learn how to take advantage of this unique opportunity for xR6000 users, contact Octane Fitness at 1.888.OCTANE4.*

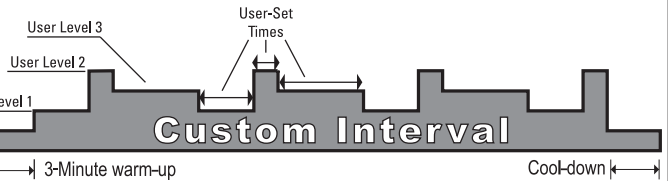

xR6000 PROGRAM REFERENCE

Use the numeric keypad or the Up Arrow (▲) and Down Arrow (▼) keys on the keypad or the right handlebar to enter program settings as prompted by the Message Center.

Programs & Standard Settings	Description
 <p style="text-align: center;">Manual</p> <p style="text-align: center;">Workout Time (30:00) Level (1) Age (40) Weight (150 lbs./68 kg)</p>	<p>Get on and go; constant resistance simulates walking or jogging on a flat surface. The oval racetrack equals 1/4 mile (or 1/4 kilometer); the counter in the matrix display shows laps completed.</p>
 <p style="text-align: center;">Random</p> <p style="text-align: center;">Workout Time (30:00) Level (1) Age (40) Weight (150 lbs./68 kg)</p>	<p>Enjoy computer-randomized resistance variation with a virtually infinite number of combinations. Get a new course each time you select the program or change the level. Each interval lasts one minute.</p>
 <p style="text-align: center;">Interval</p> <p style="text-align: center;">Workout Time (30:00) 1st Interval Level (1) 2nd Interval Level (4) Age (40) Weight (150 lbs./68 kg)</p>	<p>Add variety and challenge with 2-minute intervals of alternating user-set resistance. Use Level Up Arrow (▲) and Down Arrow (▼) on the keypad or left handlebar to adjust interval resistance mid-workout.</p>
 <p style="text-align: center;">Custom Interval</p> <p style="text-align: center;">Workout Time (30:00) How Many Intervals (3) Interval 1 — Time (00:30) Interval 1 — Level (1) Interval n — Time (00:30) Interval n — Level (1) Age (40) Weight (150 lbs./68 kg)</p>	<p>Design a custom workout of up to 6 alternating intervals of user-defined duration and resistance. Use Level Up Arrow (▲) and Down Arrow (▼) on the keypad or left handlebar to adjust interval resistance mid-workout.</p>
 <p style="text-align: center;">Hill</p> <p style="text-align: center;">Workout Time (30:00) Level (1) Age (40) Weight (150 lbs./68 kg)</p>	<p>Build strength with this simulated climb up 3 increasingly steeper hills. Each hill lasts two minutes with a 30-second recovery in between. After the biggest hill, recover for 30 seconds, then begin your climb again.</p>

xR6000 PROGRAM REFERENCE

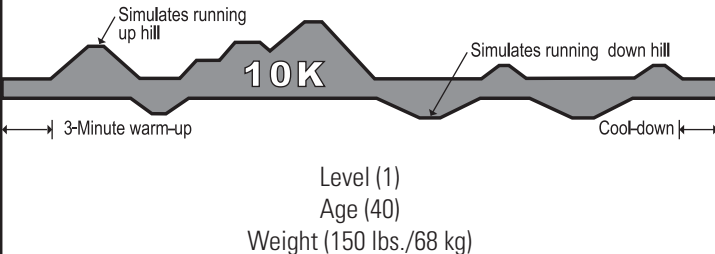
Use the numeric keypad or the Up Arrow (▲) and Down Arrow (▼) keys on the keypad or the right handlebar to enter program settings as prompted by the Message Center.

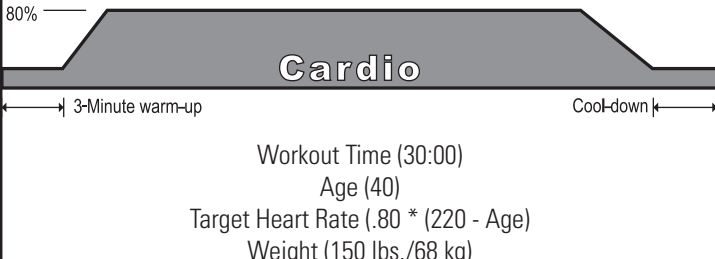
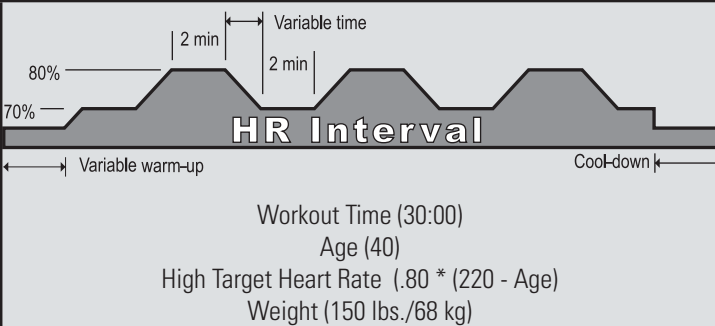
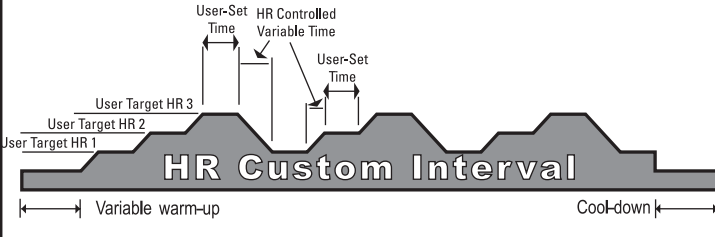
Programs & Standard Settings	Description
 <p style="text-align: center;">10K</p> <p style="text-align: center;">Level (1) Age (40) Weight (150 lbs./68 kg)</p>	<p>Complete a virtual 10K—a great way to train for an actual event. Gradual resistance changes simulate variance in terrain, replicating the challenges encountered when walking or running outside. The distance readout counts down from 6.2 miles (10 kilometers). Use Level Up Arrow (▲) and Down Arrow (▼) on the keypad or left handlebar to adjust level during the workout.</p>
 <p style="text-align: center;">Fat Burn</p> <p style="text-align: center;">Workout Time (30:00) Age (40) Target Heart Rate (.65 * (220 - Age)) Weight (150 lbs./68 kg)</p>	<p>Maximize the percentage of calories burned from fat versus carbohydrates with this controlled workout at 65% of theoretical maximum heart rate (or user-specified target heart rate). Use Level Up Arrow (▲) and Down Arrow (▼) on the keypad or left handlebar to adjust interval target heart rates mid-workout.</p>
 <p style="text-align: center;">Cardio</p> <p style="text-align: center;">Workout Time (30:00) Age (40) Target Heart Rate (.80 * (220 - Age)) Weight (150 lbs./68 kg)</p>	<p>Maximize cardiovascular benefits with this controlled workout at 80% of theoretical maximum heart rate (or user-specified target heart rate). Use Level Up Arrow (▲) and Down Arrow (▼) on the keypad or left handlebar to adjust interval target heart rates mid-workout.</p>
 <p style="text-align: center;">HR Interval</p> <p style="text-align: center;">Workout Time (30:00) Age (40) High Target Heart Rate (.80 * (220 - Age)) Weight (150 lbs./68 kg)</p>	<p>Capturing the benefits of interval training over steady-state training in this controlled workout of alternating 2-minute intervals at 70% and 80% of theoretical maximum heart rate (or user-specified target heart rate). Intervals last two minutes after the target heart rate has been reached. Use Level Up Arrow (▲) and Down Arrow (▼) on the keypad or left handlebar to adjust interval target heart rates mid-workout.</p>
 <p style="text-align: center;">HR Custom Interval</p> <p style="text-align: center;">Workout Time (30:00) Age (40) How Many Intervals (3) Interval 1 — Time (00:30) Interval 1 — Target Heart Rate (.75* (220 - Age)) Interval n — Time (00:30) Interval n — Target Heart Rate (.75* (220 - Age)) Weight (150 lbs./68 kg)</p>	<p>Build a custom heart-rate controlled workout of up to 6 alternating intervals of user-defined duration and target heart rates. Use Level Up Arrow (▲) and Down Arrow (▼) on the keypad or left handlebar to adjust interval target heart rates mid-workout.</p>

xR6000 PROGRAM REFERENCE

Use the numeric keypad or the Up Arrow (▲) and Down Arrow (▼) keys on the keypad or the right handlebar to enter program settings as prompted by the Message Center.

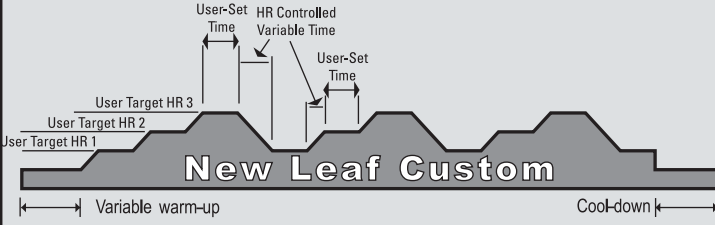
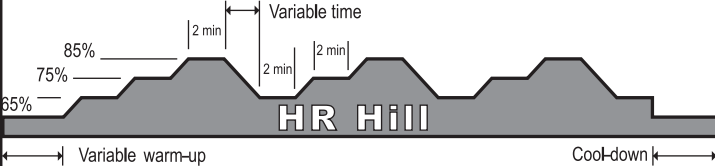
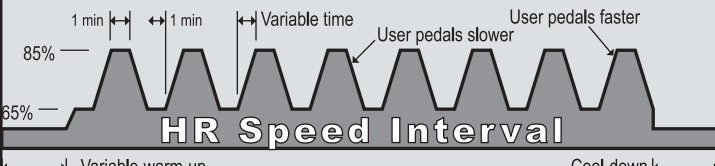
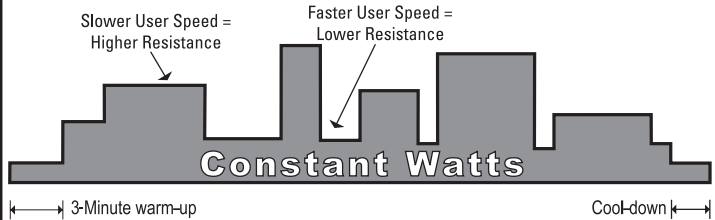
Programs & Standard Settings	Description
 <p style="text-align: center;">New Leaf Custom</p> <p>Workout Time (30:00) Age (40) How Many Intervals (3) Interval 1 — Time (00:30) Interval 1 — Target Heart Rate (.75* (220 - Age)) Interval <i>n</i> — Time Interval <i>n</i> — Target Heart Rate (.75* (220 - Age)) Weight (150 lbs./68 kg)</p>	<p>Follow the recommended plan designed just for you after completing a New Leaf fitness assessment. This controlled workout incorporates up to 6 alternating intervals of user-defined duration and target heart rates. <i>To learn about the New Leaf fitness assessment for xR6000 users, contact Octane Fitness at 1.888.OCTANE4.</i></p>
 <p style="text-align: center;">HR Hill</p> <p>Workout Time (30:00) Age (40) High Target Heart Rate (.85* (220 - Age)) Weight (150 lbs./68 kg)</p>	<p>Get a great interval workout with this controlled simulated climb of increasingly steeper hills at 65%, 75%, and 85% of theoretical maximum heart rate (or user-specified target heart rate). Each hill lasts two minutes once the target heart rate has been reached. After the biggest hill, recover until your heart rate drops back to 65%, then begin the climb again.</p>
 <p style="text-align: center;">HR Speed Interval</p> <p>Workout Time (30:00) Age (40) High Target Heart Rate (.85* (220 - Age)) Weight (150 lbs./68 kg)</p>	<p>Focus on power and speed in this controlled workout that alternates one-minute intervals of 65% and 85% of theoretical maximum heart rate (or user-specified target heart rate). This challenging workout combines steeper (higher resistance) intervals with changing speeds. Intervals last one minute after the target heart rate has been reached.</p>
 <p style="text-align: center;">Constant Watts</p> <p>Workout Time (30:00) Age (40) Weight (150 lbs./68 kg) Watts (125)</p>	<p>Set a target power output and let the machine keep you there by varying resistance level relative to your speed. Power output is measured in watts, representing the amount of power required by the machine to maintain the workload (pedal resistance and speed) that you want to experience. The higher the watts, the more difficult the workout.</p>

xR6000 PROGRAM REFERENCE

Use the numeric keypad or the Up Arrow (▲) and Down Arrow (▼) keys on the keypad or the right handlebar to enter program settings as prompted by the Message Center.

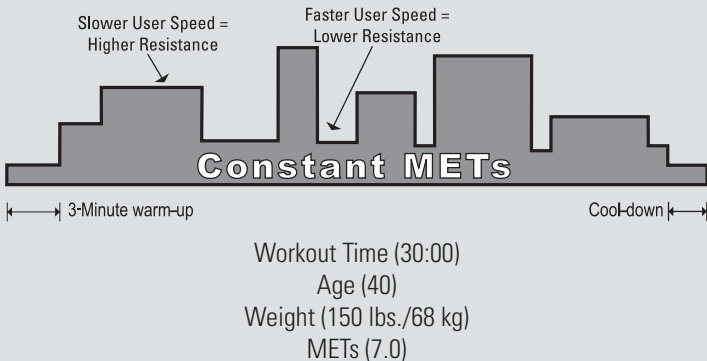
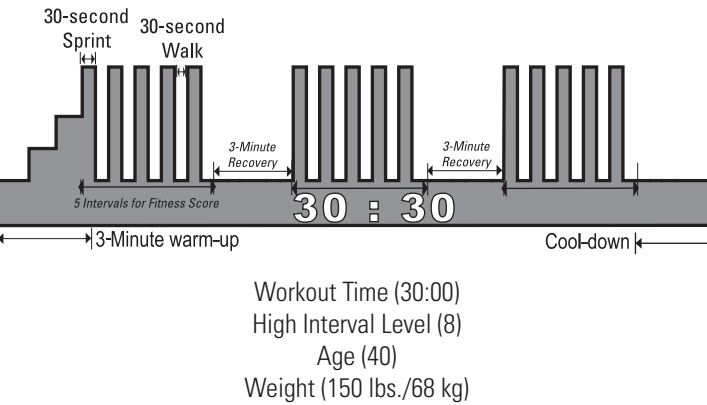
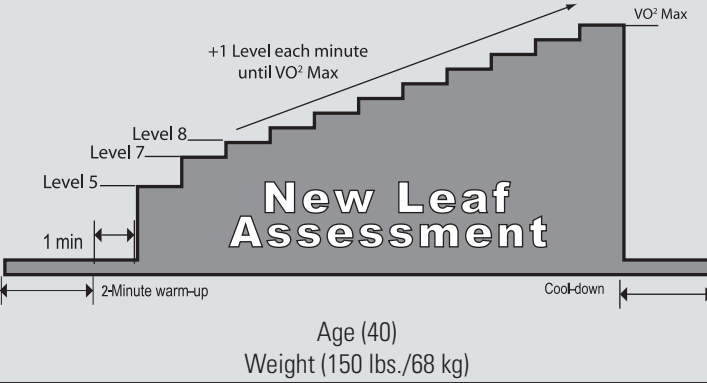
Programs & Standard Settings	Description
 <p style="text-align: center;">Constant METs</p> <p style="text-align: center;">Workout Time (30:00) Age (40) Weight (150 lbs./68 kg) METs (7.0)</p>	<p>Gauge the intensity of your workout by setting a target output measured in metabolic equivalent units (METs). The machine keeps you on goal by varying resistance level relative to speed. METs are a measure of power output, representing the ratio of a person's working metabolic rate relative to that person's resting metabolic rate. One MET is approximately equal to 1 kilocalorie burned per kilogram per hour. The greater the METs, the harder the workout.</p>
 <p style="text-align: center;">30 : 30</p> <p style="text-align: center;">Workout Time (30:00) High Interval Level (8) Age (40) Weight (150 lbs./68 kg)</p>	<p>This challenging program provides a simple test of fitness level with 5 sets of 30-second sprint and recovery intervals. For each set, the program monitors heart rate and calculates the average minimum and average maximum heart rates and the average number of beats the heart rate recovers between sprint intervals. Heart rate recovery is a relative indicator of fitness level; a higher number indicates a more rapid heart rate recovery and therefore represents a relatively better level of fitness.</p>
 <p style="text-align: center;">New Leaf Assessment</p> <p style="text-align: center;">Age (40) Weight (150 lbs./68 kg)</p>	<p>A specialized interval program for use by New Leaf Fitness professionals as part of an Active Metabolic Assessment. This program requires the use of a breathing mask and external computer monitoring. <i>To learn how to take advantage of this unique opportunity for xR6000 users, contact Octane Fitness at 1.888.OCTANE4.</i></p>

**Standard program values are used if no values are entered within 4 seconds of Message Center prompts.*

xR6000 SETTINGS—VALUE RANGES

Setting	Standard Values*	Minimum Value	Maximum Value
Workout Time	30:00	1:00	99:00
Level	1	1	30
Age	40	15	99
Weight	150 lbs. (68 kg)	70 lbs. (32 kg)	400 lbs. (181 kg)
Interval Time	00:30	00:15	99:00
Interval Level	1	1	30
How Many Intervals	3	2	6
Target Heart Rate	(220 - Age) * %; varies by program	80	(220 - Age)
Watts	125	20	900
METs	7.0	1.0	61.9

**Standard program values are used if no values are entered within 4 seconds of Message Center prompts.*

xR6000 PRODUCT FEATURES

The Octane Fitness xR6000 seated elliptical incorporates additional features to ensure that your users experience great workouts, including HeartLogic Intelligence and MultiGrip Handlebars. In addition, many of the standard features and controls of your Octane Fitness seated elliptical can be customized to fit your personal preferences or workout environment.

HeartLogic Intelligence

The xR6000 is equipped with HeartLogic Intelligence—Octane’s own heart rate control technology. HeartLogic Intelligence is a sophisticated yet easy to use technology that provides the most accurate and effective workout possible. It all begins with the wireless chest strap and the digital contact heart rate grip sensors on the stationary handlebars. There are seven different heart rate programs—Fat Burn, Cardio, Heart Rate Interval, Heart Rate Hill, Heart Rate Speed Interval, Heart Rate Custom Interval, and New Leaf Custom—to keep workouts fun and interesting. To top it all off, the console displays time-in-zone, current heart rate, heart rate %, and target heart rate so you know exactly where you are and where you should be.

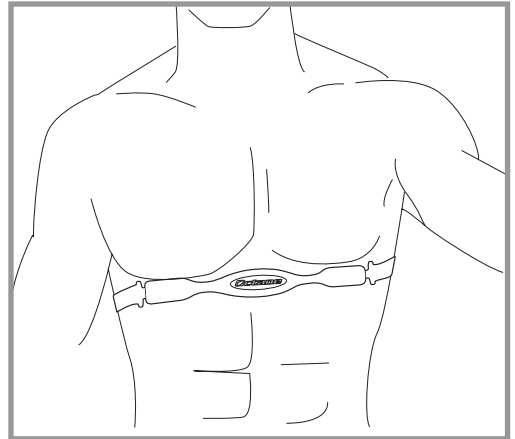

Using your wireless chest strap

The wireless chest strap transmits heart rate to the electronics console at a distance of up to three feet. Adjust the length of the elastic strap and fasten it to the transmitter around the torso, underneath the shirt. Place the strap just below the chest. Make sure the Octane Fitness logo is away from you and right side up. It may help to moisten the electrodes on the back of the transmitter with a small amount of water for better contact with the skin. (The electrodes are the ribbed portion on the back side of the transmitter that sits against the skin.) Make sure the strap fits snugly but doesn’t restrict breathing.

Using the contact heart rate sensors

The digital contact heart rate sensors are located on the stationary handlebars of the xR6000. These sensors provide an easy and accurate way to track heart rate for a great workout. For the most accurate heart rate reading possible, wrap your hands around each contact heart rate grip so that the palm of the hand and the fingers make contact with the metal sensors on the top and bottom of each grip. Grasp firmly, and keep hands steady and in place.

Heart rate controlled programs

The xR6000 provides different heart rate controlled programs to offer you more variety to suit personal needs: Fat Burn, Cardio, Heart Rate Interval, Heart Rate Hill, Heart Rate Speed Interval, Heart Rate Custom Interval, and New Leaf Custom. In addition, the 30:30 performance program uses heart rate readings as a measure of overall fitness. Try different programs to determine a favorite. In a heart rate controlled program, current heart rate is monitored and the resistance level will automatically adjust to maintain target heart rate. To change the target heart rate during a workout, use the Level ▲/▼ keys on the keypad or the left stationary handlebar.

MultiGrip Handlebars

The Octane Fitness xR6000 features one-of-a-kind handlebars that deliver the ultimate upper-body workout with virtually unlimited options for maximal comfort, customization and effectiveness. The unique MultiGrip handlebars are only offered by Octane, and these innovative handlebars have revolutionized upper-body workouts. The MultiGrip handlebars are comfortable in any position and offer users the flexibility find the positions that work best for them.

The unique design of the MultiGrip handlebars provide a multitude of choices that result in the most comfortable and ergonomically correct positions of any cross trainer. Exercisers will feel the difference! Here's how they can be put to work:

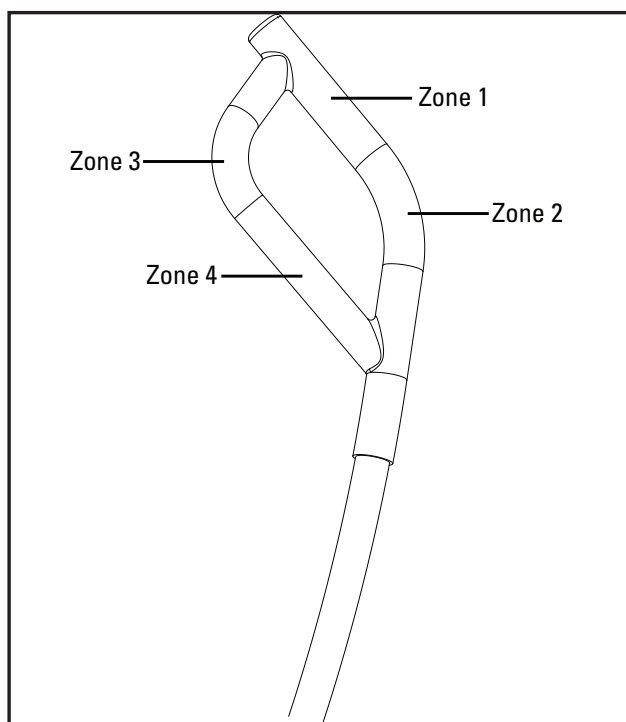

Zone 1	Top angled position	Ideal for pushing Gives longer range of motion Engages the deltoid (shoulder), pectoral (chest), and lat (back) muscles
Zone 2	Large corner position—wide grip	Push with the palms; better stability for a wide-grip chest press motion Focuses more on using the pectoral (chest) and lat (back) muscles
Zone 3	High inside angled position	Perfect for biceps curls and lats (back) on the pull motion.
Zone 4	Mid- to Low-inside position	Great for pectorals (chest) and triceps on the push motion. Engages lat (back) and biceps on the pull motion.

No matter what position or zone is selected, exercisers are working numerous different muscle groups throughout the upper body to get a true elliptical cross training workout. Emphasize either a push or pull movement or reposition the hands any time during any workout program for maximal muscle exertion, variety, and comfort.

The innovative choices of the MultiGrip handlebars, combined with Octane's variety of interactive cross-training workouts, create enjoyable, effective exercise sessions that produce astonishing results.

Fingertip Controls

The xR6000 also features fingertip control buttons on the stationary handlebars. Users can easily set up or adjust their workout using the Up Arrow (▲) and Down Arrow (▼) and Enter buttons on the right stationary handlebar. Or, adjust the Level (or Target Heart Rate) while in a workout using the Level Up Arrow (▲) and Down Arrow (▼) on the left stationary handlebar. These convenient buttons let users adjust settings to meet their needs without breaking the flow of the workout.

Learn More at www.octanefitness.com

Log on to www.octanefitness.com where you will find additional information about product features and answers to many common questions and tips on using your elliptical. If you would like to speak to an Octane Fitness Customer Service specialist, please call 1-888-OCTANE4 or 763-757-2662 extension 1. Enjoy your xRide!

Are you passionate about your workout and the results?

Share your story with others on the Octane Fitness web site.

Go to: ***www.octanefitness.com/testimonials***

Then click on "Share My Story" and
show the world how fueled you are.

www.octanefitness.com

www.youtube.com/user/octanefitness

 Find us on
Facebook *www.facebook.com/octanefitness*

F U E L Y O U R L I F E TM



Octane Fitness

US & Canada, Latin America, Asia & Asian Pacific

7601 Northland Drive North

Suite 100

Brooklyn Park, MN 55428

Phone: 888.OCTANE4 (US and Canada)

763.757.2662 (Latin America, Asia and Asian Pacific)

Fax: 763.323.2064

Octane Fitness International

Europe, Middle East, Africa

Rivium Weestlaan 19

2909 LD, Capelle a/d IJssel

The Netherlands

Phone: +31 10 2662412

Fax: +31 10 2662444

© 2011 Octane Fitness, LLC. All rights reserved. Octane Fitness, DedicatedLogic, Fuel Your Life, HeartLogic, Now-Zone, Muscle Endurance, Chest Press, and Leg Press are registered trademarks of Octane Fitness. Any use of these trademarks, without the express written consent of Octane Fitness, is forbidden.

103262-001 REV G