

OWNER'S MANUAL

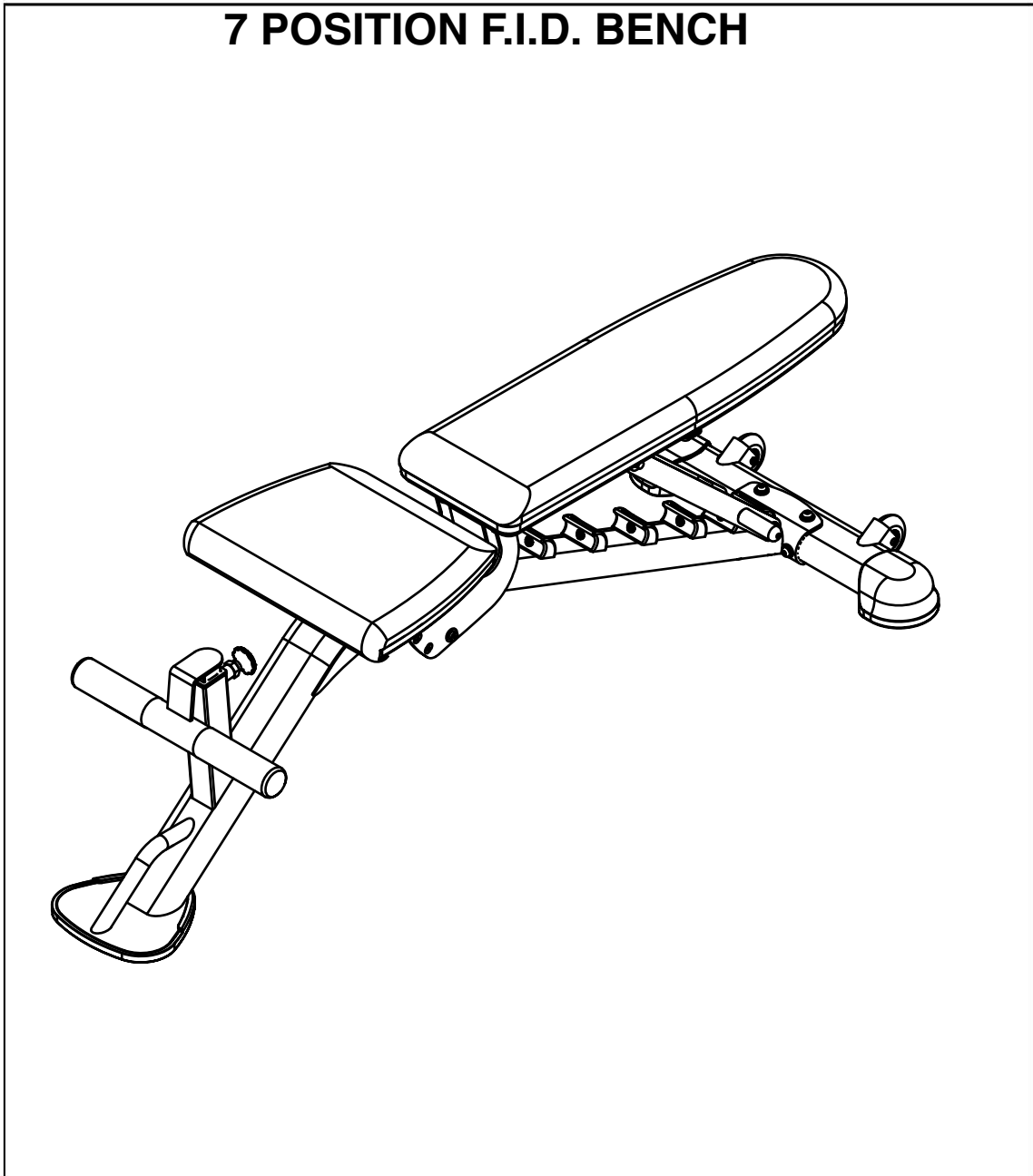

HF-5165

7 POSITION F.I.D. BENCH



Note: Both Serial Number and Model Number are Required when Ordering Parts

RECORD SERIAL NUMBER HERE

MACHINE CODE

Customer Service

(800) 548-5438

(858) 578-7676

Fax

(858) 578-9558



www.facebook.com/hoistfitness

OWNER'S MANUAL

CONTENTS

INSTRUCTIONS.....	02
FRAME ASSEMBLY.....	04
PRE-ASSEMBLY.....	11
DECAL PLACEMENT.....	12
DECAL REFERENCE.....	13
PART LIST.....	14
ABBREVIATIONS.....	16
BOLT SIZING CHART.....	17
WASHER SIZING CHART.....	18
MAINTENANCE SCHEDULE.....	20
GENERAL MAINTENANCE INFORMATION.....	21
WEIGHT TRAINING TIPS.....	22
EXERCISE LOG.....	23
LIMITED WARRANTY.....	24

OWNER'S MANUAL

INSTRUCTIONS

Before beginning assembly please take the time to read instructions thoroughly. Please use the various lists in this manual to make sure that all parts have been included in your shipment. When ordering, use part number and description from the lists. Use only HOIST replacement parts when servicing. Failure to do so will void your warranty and could result in personal injury.

HOIST equipment is designed to provide the smoothest, most effective exercise motion possible. After assembly, you should check all functions to ensure correct operation. If you experience problems, first recheck the assembly instructions to locate any possible errors made during assembly. If you are unable to correct the problem, call your authorized HOIST dealer. Be sure to have your serial number and this manual when calling. When all parts have been accounted for, continue on.

TOOLS REQUIRED

Ratchet Wrench

1/2", 9/16" and 3/4" Sockets

Adjustable Wrench

Rubber Mallet

Tape Measure

Level

SAE Hex Key Wrench Set

OWNER'S MANUAL

*****THIS PAGE WAS INTENTIONALLY LEFT BLANK*****

OWNER'S MANUAL

FRAME ASSEMBLY

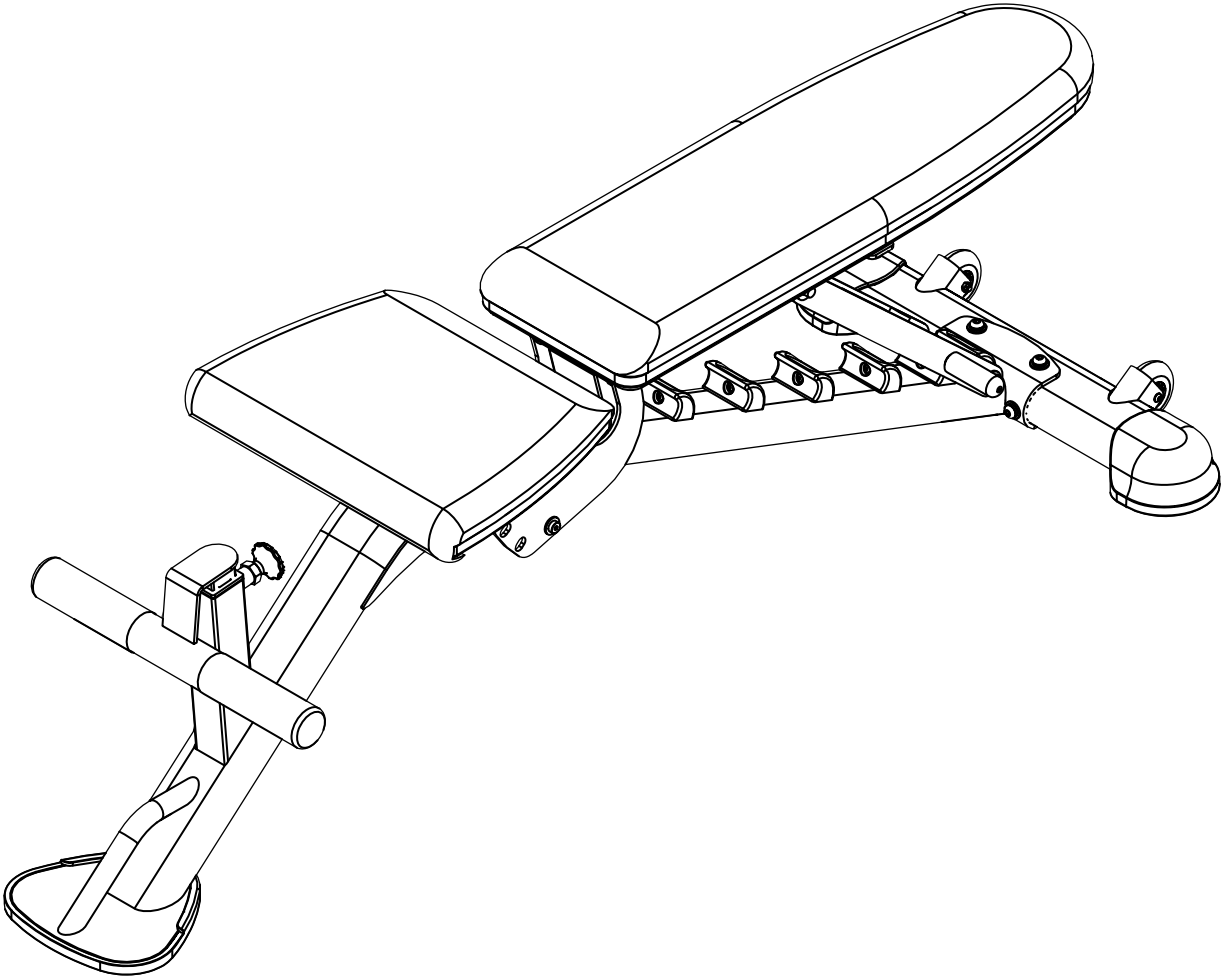

OWNER'S MANUAL

FRAME ASSEMBLY

NOTE:
- HAND TIGHTEN HARDWARE
- SOME PARTS MAY HAVE BEEN REMOVED FOR CLARITY.

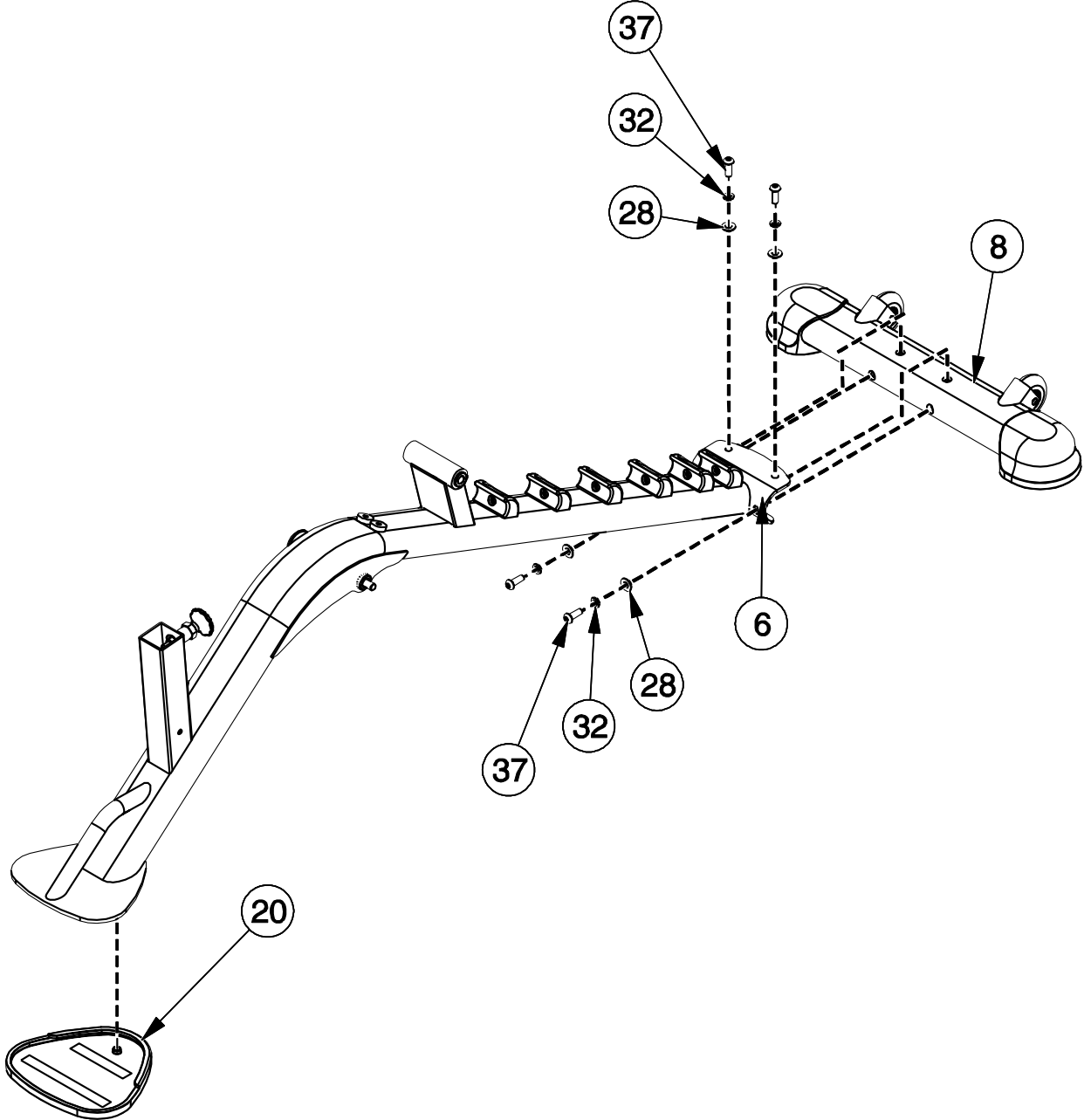

OWNER'S MANUAL

FRAME ASSEMBLY

NOTE:
- WRENCH TIGHTEN BOLT (40) THEN
 LOOSEN NUT JUST ENOUGH FOR
 (7) & (9) TO PIVOT FREELY.
- SOME PARTS MAY HAVE BEEN
 REMOVED FOR CLARITY.

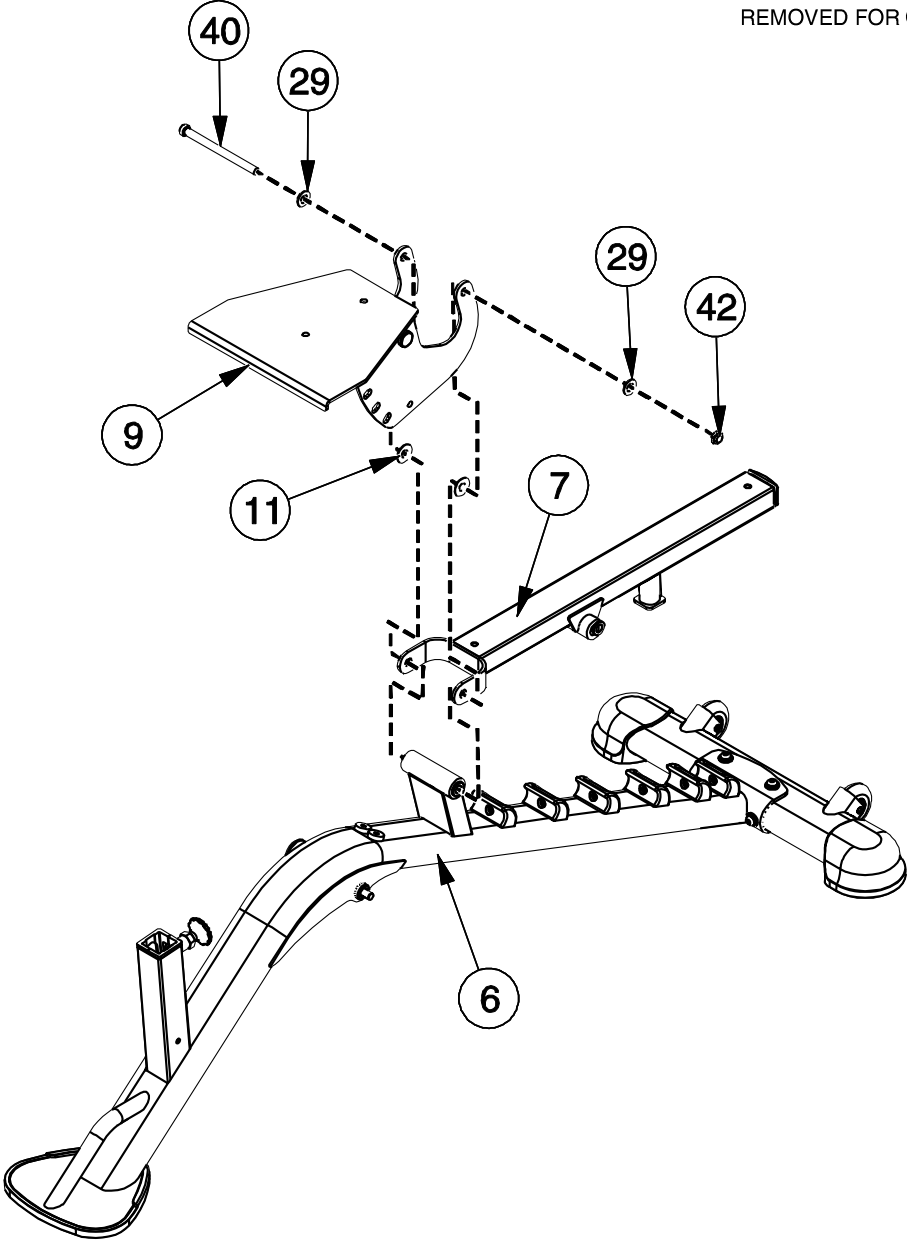

OWNER'S MANUAL

FRAME ASSEMBLY

NOTE:
- WRENCH TIGHTEN BOLT (39) THEN
 LOOSEN NUT JUST ENOUGH FOR (10)
 TO PIVOT FREELY.
- SOME PARTS MAY HAVE BEEN
 REMOVED FOR CLARITY.

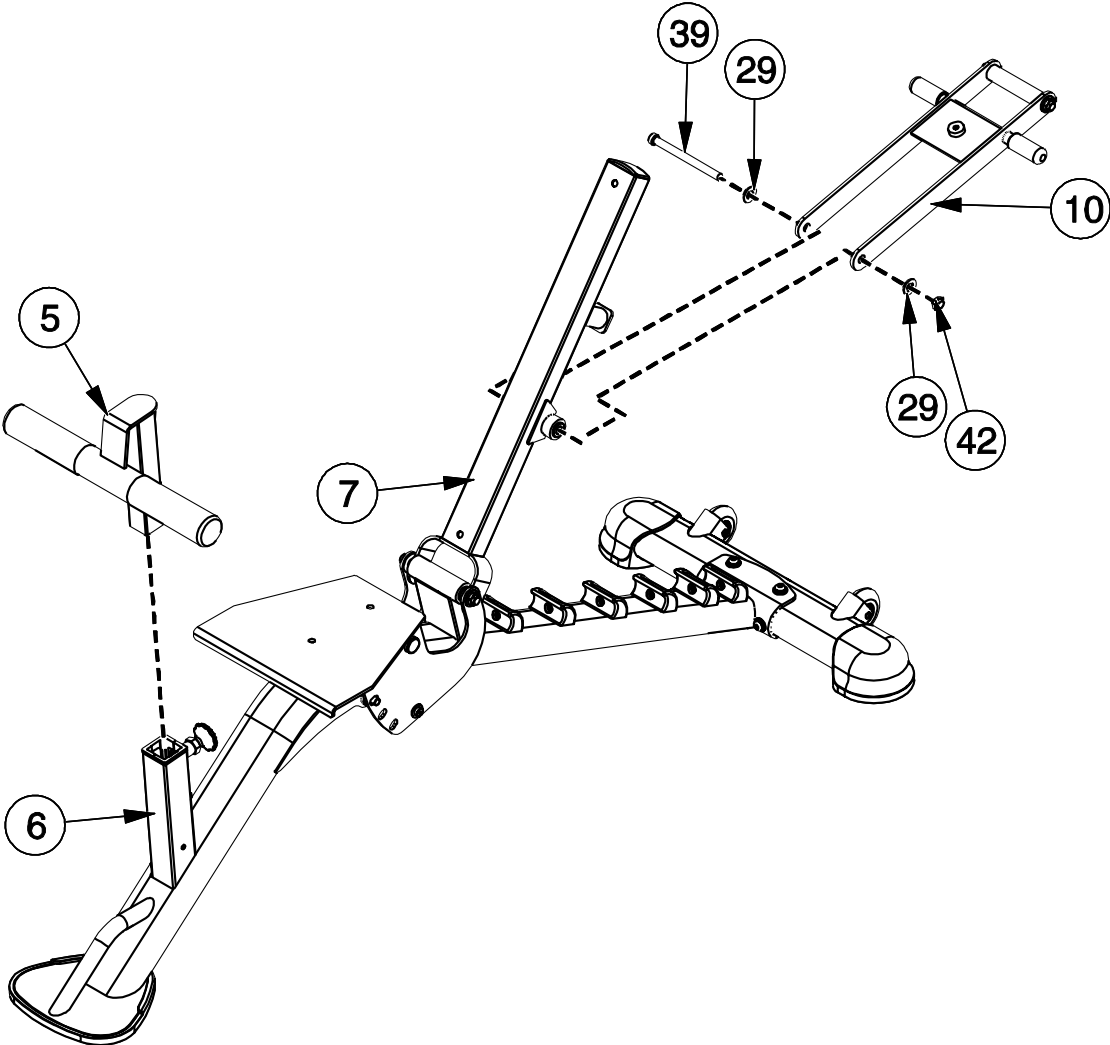

OWNER'S MANUAL

FRAME ASSEMBLY

NOTE:
- WRENCH TIGHTEN HARDWARE.
- SOME PARTS MAY HAVE BEEN
REMOVED FOR CLARITY.

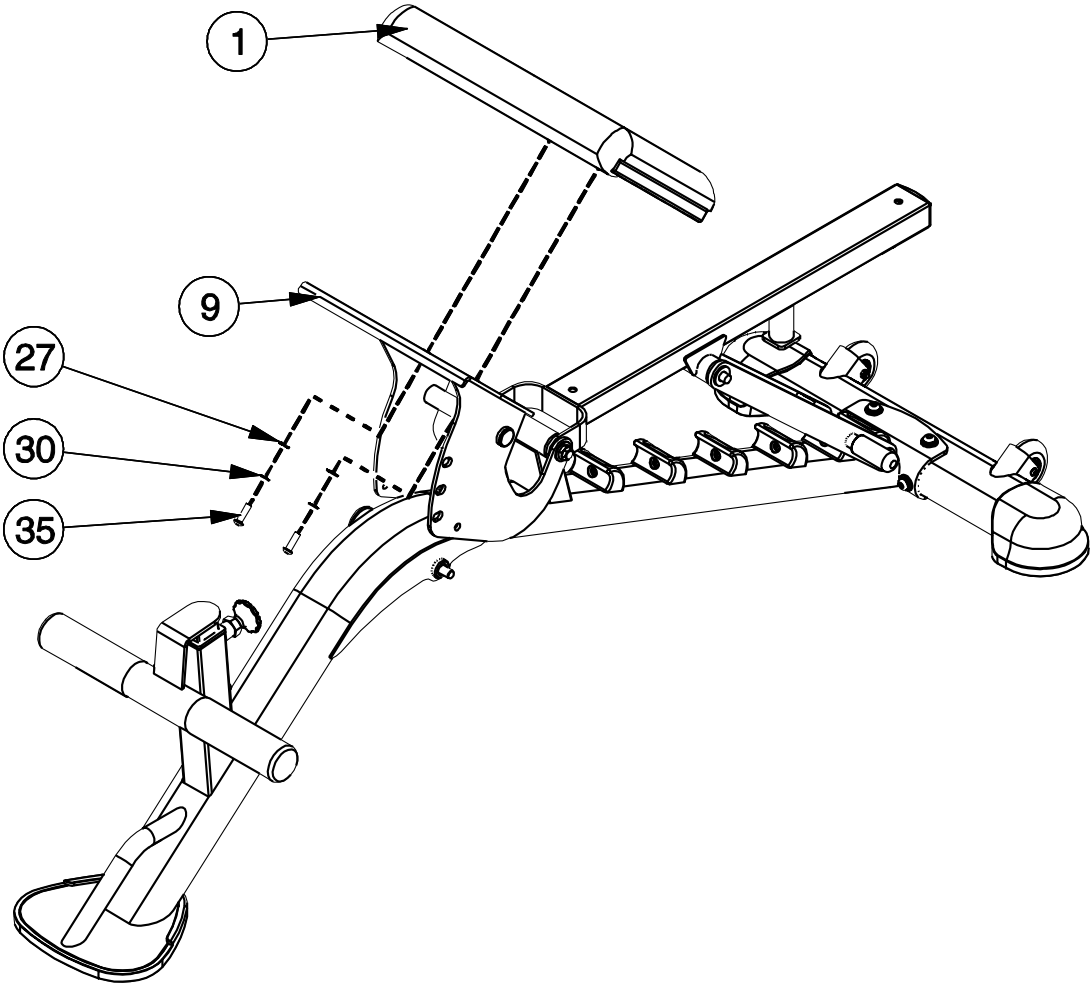

OWNER'S MANUAL

FRAME ASSEMBLY

NOTE:
- WRENCH TIGHTEN HARDWARE.
- SOME PARTS MAY HAVE BEEN
REMOVED FOR CLARITY.

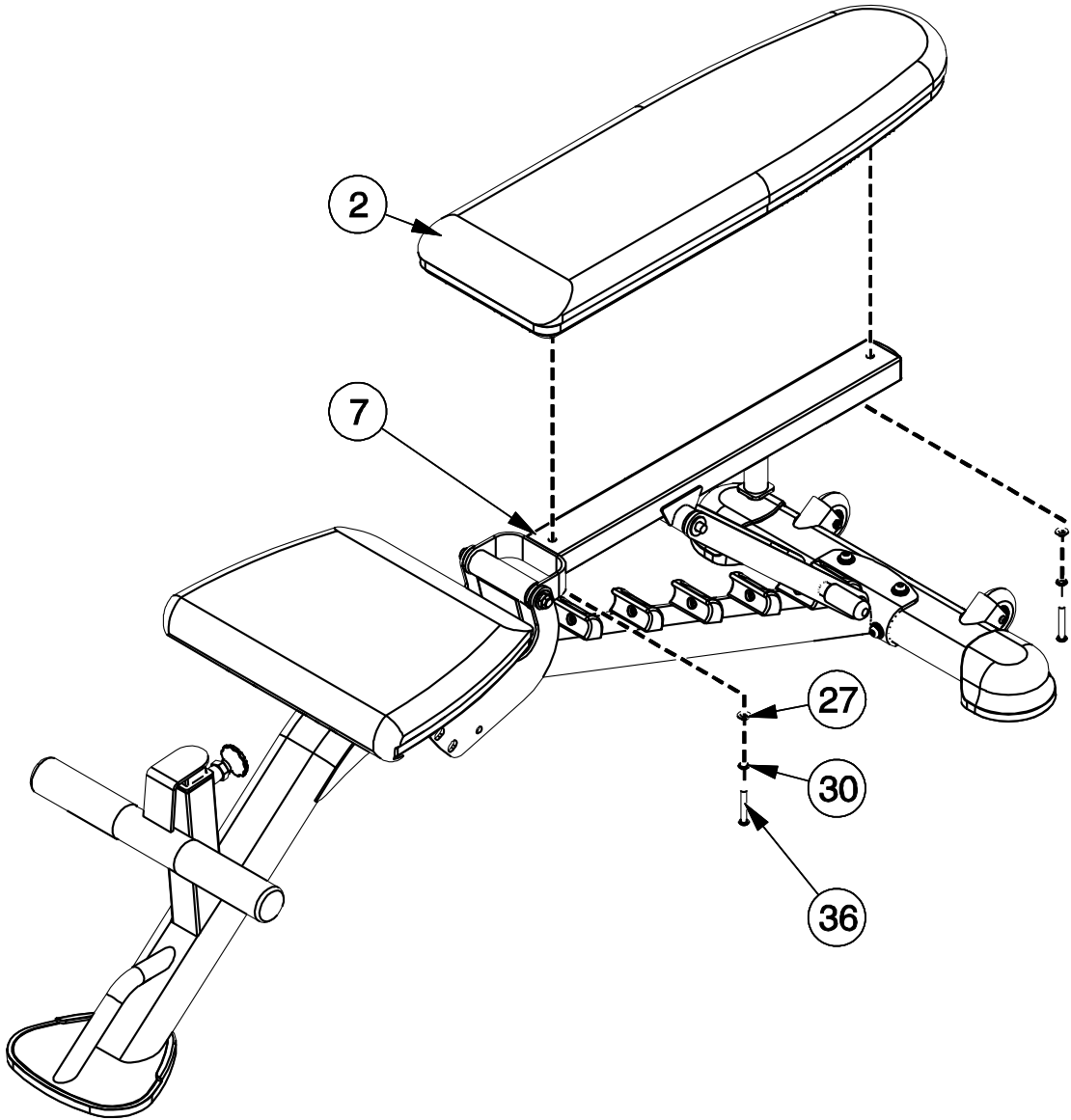

OWNER'S MANUAL

FRAME ASSEMBLY

NOTE:

- WRENCH TIGHTEN HARDWARE.
- WRENCH TIGHTEN ALL PREVIOUSLY HAND TIGHTENED HARDWARE.

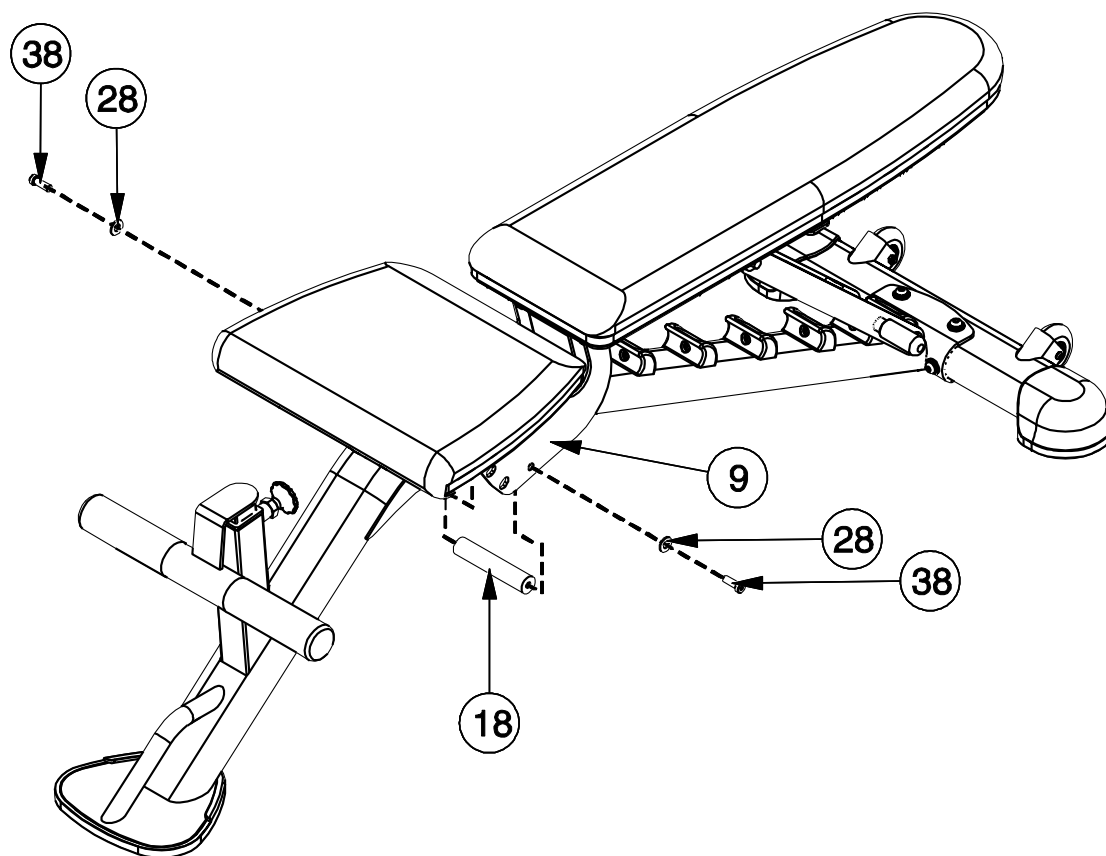

IMPORTANT

NOW THAT THE HF-5165 IS COMPLETELY ASSEMBLED, TAKE TIME TO ASSURE THAT YOUR UNIT IS ASSEMBLED SQUARE AND PERPENDICULAR. IF IT IS NOT, IT WILL BE NECESSARY TO LOOSEN SOME FRAME HARDWARE TO RE-ALIGN THE FRAME AND RETIGHTEN BOLTS.

OWNER'S MANUAL

PRE-ASSEMBLY

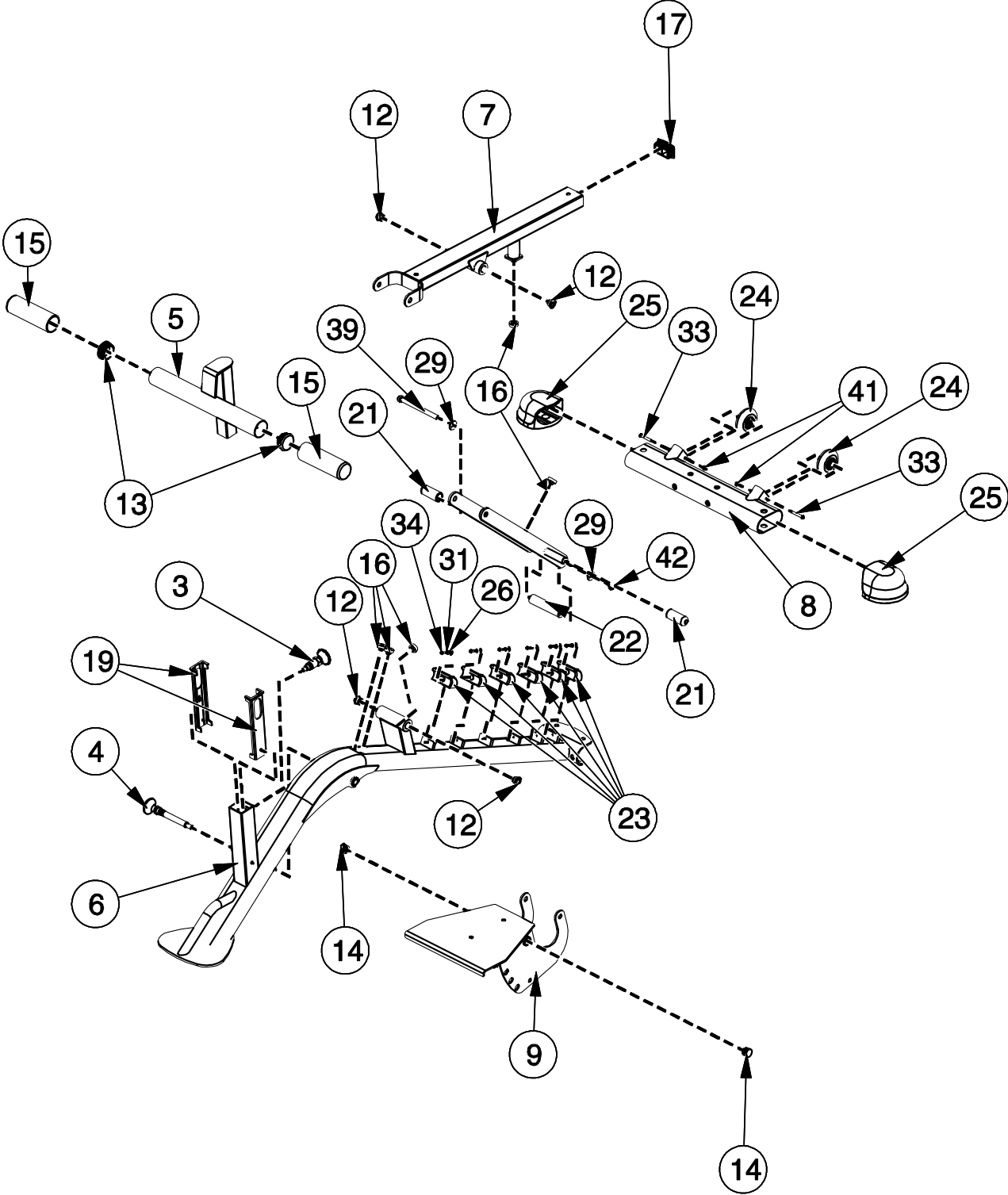

OWNER'S MANUAL

DECAL PLACEMENT

NOTE:
- ALL DECALS ARE CENTERED
UNLESS OTHERWISE STATED.

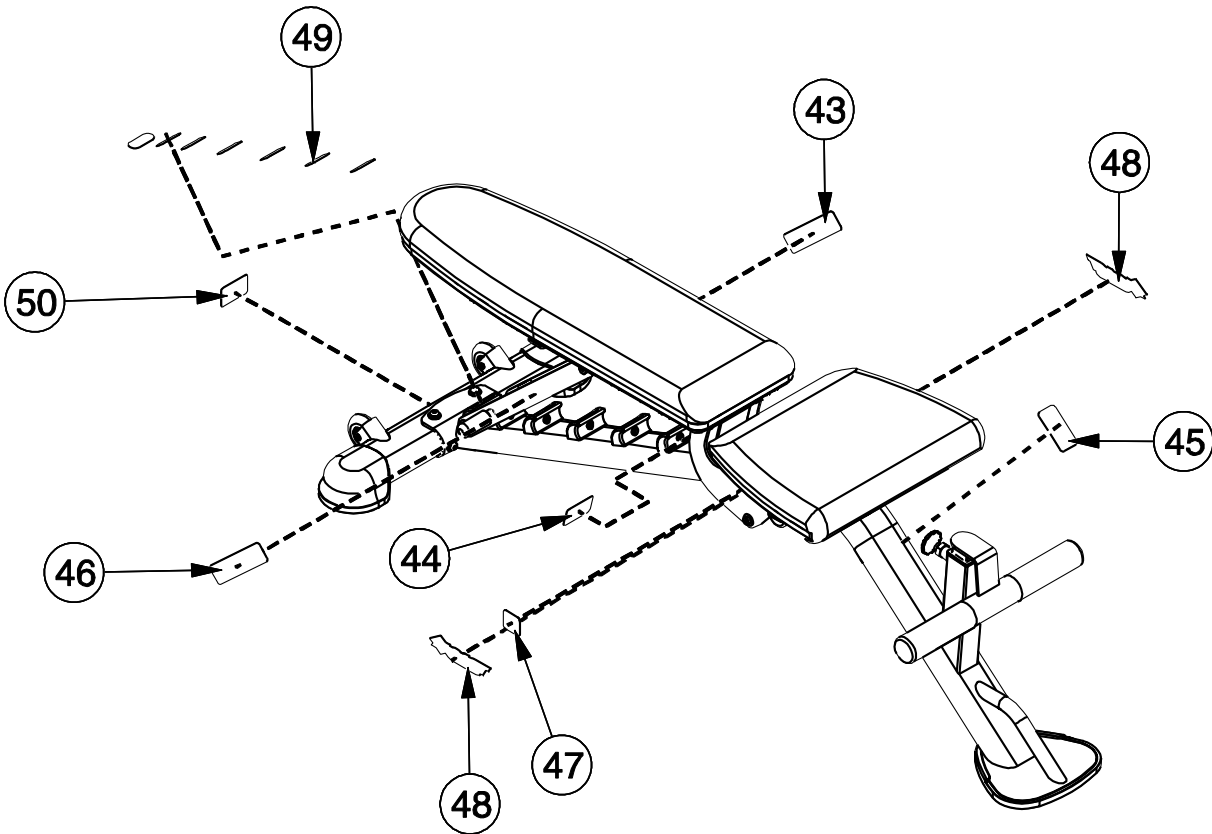

OWNER'S MANUAL

DECAL REFERENCE

80



021-0003230

60



45



021-0003229

021-0003113

30

WARNING

USE ONLY GENUINE HOIST REPLACEMENT PARTS. FAILURE TO DO SO WILL VOID WARRANTY AND COULD RESULT IN PERSONAL INJURY OR EVEN DEATH. THERE IS A RISK ASSUMED BY INDIVIDUALS WHO USE THIS TYPE OF EQUIPMENT. TO MINIMIZE THE RISK, ALWAYS FOLLOW THESE SIMPLE RULES.

1. READ AND UNDERSTAND ALL ENCLOSED INSTRUCTIONS before using this equipment.
2. INSPECT EQUIPMENT BEFORE EACH USE. Replace all parts at the first signs of wear or damage. If in doubt about a certain part, DO NOT use the equipment until the part is replaced. Failure to replace worn or damaged parts may result in injury.
3. FOLLOW ROUTINE MAINTENANCE SCHEDULE. Refer to the owner's manual/maintenance decal.
4. CONSULT YOUR PHYSICIAN BEFORE STARTING ANY EXERCISE PROGRAM. Warm up properly before engaging in weight resistance training. Stop exercising if you feel faint, dizzy or pain.
5. TO PREVENT THE POSSIBILITY OF SERIOUS INJURY, KEEP CLEAR OF ALL MOVING PARTS. Do not attempt to free any jammed parts by yourself. Obtain assistance to avoid possible injury.
6. CHILDREN SHOULD NOT BE ALLOWED TO USE THIS EQUIPMENT WITHOUT ADULT SUPERVISION. To avoid possible injury, bystanders should be kept at a safe distance when this equipment is in use.
7. CALL YOUR AUTHORIZED DISTRIBUTOR if you have any questions on the proper use or maintenance of this equipment.
8. TO PREVENT POSSIBLE TIPPING bolt this unit to the exercise floor. Failure to do so may result in serious injury or death.

021-0003135 (Rev. F)

021-0003135

NOTICE

COMMERCIAL MAINTENANCE	Daily	Weekly	Monthly	Yearly
Inspect; Links, Pull Pins, Snap Locks, Swivels, Weight Stack Pins		X		
Clean; Upholstery		X		
Inspect; Cables or Belts and their tension		X		
Inspect; Accessory Bars and Handles			X	
Inspect; All Decals			X	
Inspect; All nuts and Bolts Tighten if Needed.			X	
Inspect; Anti-Skid Surfaces			X	
Clean & Lubricate; Guide Rods with a Teflon (PTFE) based lubricant (Superlube)				X
Lubricate; Seat Sleeves, Turcite Bushings, Linear Bearing				X
Clean & Wax; All Glossy Finishes				X
Repack with Grease Linear Bearings.				X
Replace; Cables, Belts and Connecting Parts.				X

021-0003008

021-0003008



021-0003138

15

HOIST
HOISTFITNESS.COM

1-800-548-5438
www.hoistfitness.com
SERIAL # 00-00-A-000000

SERIAL # DECAL

0

20

021-0003950

OWNER'S MANUAL

PART LIST

NOTE: SOME OF THESE PARTS MAY COME PRE-INSTALLED

ITEM NO.	PART NUMBER	DESCRIPTION	QTY.
1	022-01PD2041-A	UPHOLSTERY PAD W/VINYL BACKING	1
2	022-01PD2042-A	UPHOLSTERY PAD W/ACX BACKING	1
3	026-01X2161	THREADED PULL-PIN ASSEMBLY	1
4	026-01X2416	PULL-PIN ASSEMBLY	1
5	026-01X2536	FOOT PEG ASSEMBLY	1
6	026-01X6652	MAIN FRAME ASSEMBLY	1
7	026-01X6683	BACK PAD MOUNT	1
8	026-01X6684	REAR BASE ASSY.	1
9	026-01X6685	SEAT MOUNT	1
10	026-01X6686	SUPPORT ASSEMBLY	1
11	013-0102006	1/2" FLAT NYLON WASHER	2
12	014-0101002	BUSHING: OILITE FLANGED Ø.75" O.D X Ø.50" I.D X .38" LG.	4
13	016-0201017	END CAP Ø2.00" X .06" WALL (BLACK)	2
14	016-0201037	Ø1.00" ENDCAP (DOMED) - GREY	2
15	019-0002002	CLOSED END GRIP Ø2.00"	2
16	019-0001001	PLUG BUMPER	5
17	016-0201036	END CAP 1.50" X 2.50" (BLACK)	1
18	026-01M0888	SHAFT Ø1.00" X 5.00" LG.	1
19	026-01PL0125THIN	E-Z GLIDE PLASTIC SLEEVE	2
20	026-01PL2503	RUBBER FOOT 8.41" X 9.13"	1
21	026-01PL2710	SLEEVE, 1.0125" OD X 3.0000"LG	2
22	026-01PL2397	Ø1.0000" X .5156" ID X 4.4000" LG. SPACER	1
23	026-01PL2559	SUPPORT CATCH	6
24	368-4-5004-00	Assy, wheel, transport	2
25	026-01PL2641	FOOTCAP, 1.9685" X 3.9370" F.O.	2
26	013-1002011	#10 FLAT WASHER (Ni)	6
27	013-1002010	5/16" SAE FLAT WASHER (Ni)	4
28	013-1002007	3/8" X 22mm FLAT WASHER (Ni)	6
29	013-1002006	1/2" X 27mm SAE FLAT WASHER (Ni)	6
30	013-1010003	5/16" INTERNAL LOCK WASHER (Ni)	4
31	013-1010007	#10 INTERNAL LOCK WASHER (Ni)	6
32	013-1006003	3/8" SPLIT LOCK WASHER (Ni)	4
33	011-0701138	M6-1.00 X 40 BHB (Ni)	2
34	011-0701119	#10-32UNC x .5 with Nylon Patch BHCS (Ni)	6
35	011-0701003	5/16"-18UNC X 1.00" BHCS (Ni)	2

OWNER'S MANUAL

PART LIST CONTINUED

NOTE: SOME OF THESE PARTS MAY COME PRE-INSTALLED

ITEM NO.	PART NUMBER	DESCRIPTION	QTY.
36	011-0701010	5/16"-18UNC X 2.75" BHCS (Ni)	2
37	011-0701111	3/8"-16UNC X 1.00" BHCS (Ni) W/ DRI-LOC PATCH	4
38	011-0116142	3/8"-16UNC X 1.00" LOW HEAD SHCS (Ni)	2
39	011-0116125	1/2"-13UNC X 5.50" LOW HEAD SHCS (Ni)	2
40	011-0116127	1/2"-13UNC X 6.00" LOW HEAD SHCS (Ni)	1
41	012-0504018	M6-1.00 Thin Nylock Nut (Ni)	2
42	012-0504002	1/2"-13 UNC THIN NYLOCK NUT (Ni)	3
43	021-0003008	DECAL COMMERCIAL MAINTENANCE 1.50 X 6.69	1
44	021-0003138	DECAL PINCH POINT 1.63" X 2.63" (HORIZONTAL)	1
45	021-0003113	DECAL PINCH POINT 1.63" X 3.25" (VERTICAL)	1
46	021-0003135	DECAL WARNING 1.50" X 7.75"	1
47	021-0003229	DECAL 1000 LB. WEIGHT RATING 1.63" X 1.63"	1
48	021-0003230	DECAL HOIST 1.625" X 6.0613"	2
49	021-0003950	DECAL: -20,0,15,30,45,60,80	1
50	SERIAL # DECAL	DECAL SERIAL # 1.63" X 2.63"	1

OWNER'S MANUAL

ABBREVIATIONS

BZ = Black Zinc
Ni = Nickel Plated
SS = Stainless Steel
WZ = White Zinc

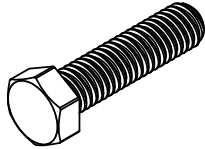

HHB = Hex Head Bolt

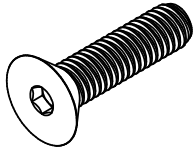

FHCS = Flat Head Cap Screw

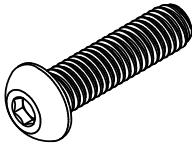

BHCS = Button Head Cap Screw

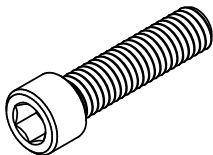

SHCS = Socket Head Cap Screw

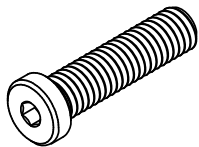

Low Head SHCS = Low Head Socket
Head Cap Screw

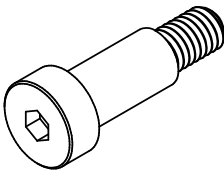

SHSS = Socket Head Shoulder Screw

OWNER'S MANUAL

BOLT SIZING CHART

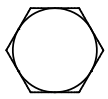

1/4" HHB
RECOMMENDED
TORQUE RANGE:
6-8 ft-lbs

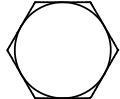

5/16" HHB
RECOMMENDED
TORQUE RANGE:
14-17 ft-lbs

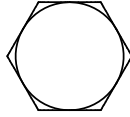

3/8" HHB
RECOMMENDED
TORQUE RANGE:
24-30 ft-lbs

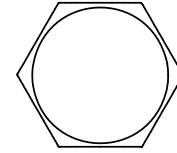

1/2" HHB
RECOMMENDED
TORQUE RANGE:
60-75 ft-lbs



1/4" BHCS
RECOMMENDED
TORQUE RANGE:
5-7 ft-lbs

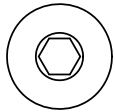

5/16" BHCS
RECOMMENDED
TORQUE RANGE:
11-15 ft-lbs

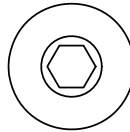

3/8" BHCS
RECOMMENDED
TORQUE RANGE:
19-26 ft-lbs

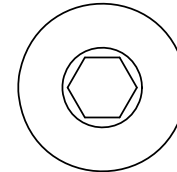

1/2" BHCS
RECOMMENDED
TORQUE RANGE:
47-65 ft-lbs



1/4" LOW HEAD SHCS
RECOMMENDED
TORQUE RANGE:
4-6 ft-lbs

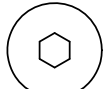

5/16" LOW HEAD SHCS
RECOMMENDED
TORQUE RANGE:
9-12 ft-lbs

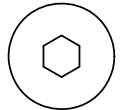

3/8" LOW HEAD SHCS
RECOMMENDED
TORQUE RANGE:
18-23 ft-lbs

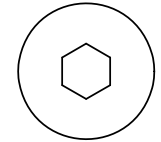

1/2" LOW HEAD SHCS
RECOMMENDED
TORQUE RANGE:
40-50 ft-lbs



1/4" SHCS
RECOMMENDED
TORQUE RANGE:
11-14 ft-lbs

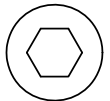

5/16" SHCS
RECOMMENDED
TORQUE RANGE:
23-29 ft-lbs

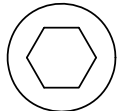

3/8" SHCS
RECOMMENDED
TORQUE RANGE:
39-49 ft-lbs

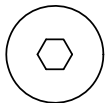
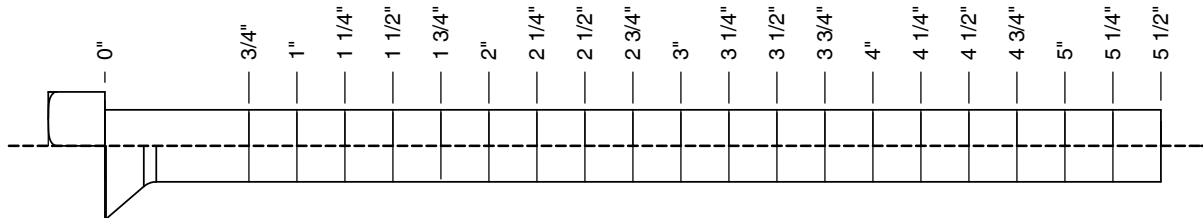

1/4" FHCS
RECOMMENDED
TORQUE RANGE:
5-7 ft-lbs

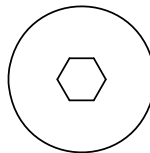

3/8" FHCS
RECOMMENDED
TORQUE RANGE:
19-26 ft-lbs

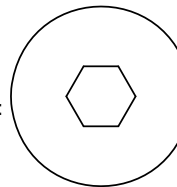

1/2" FHCS
RECOMMENDED
TORQUE RANGE:
47-65 ft-lbs

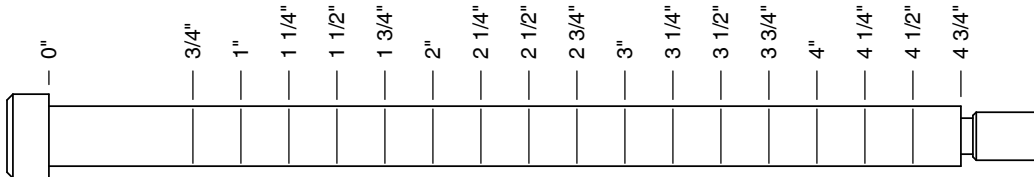

1/4" SHSS
RECOMMENDED
TORQUE RANGE:
3-4 ft-lbs



5/16" SHSS
RECOMMENDED
TORQUE RANGE:
8-10 ft-lbs

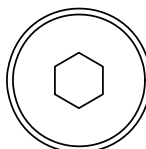

3/8" SHSS
RECOMMENDED
TORQUE RANGE:
17-22 ft-lbs

OWNER'S MANUAL

WASHER SIZING CHART

013-0002003
1/4"
FLAT WASHER
SMALL, SAE, 13mm

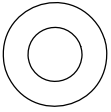

013-0102004
5/16"
FLAT WASHER
LARGE, USS, 22mm

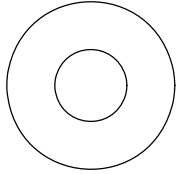

013-0002004
3/8"
FLAT WASHER
SMALL, SAE, 21mm

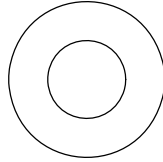

013-0402005
3/8"
FLAT WASHER
LARGE, USS, 25mm

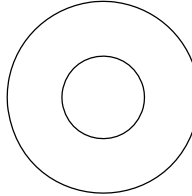

013-0102003
1/2"
FLAT WASHER
SMALL, SAE, 27mm

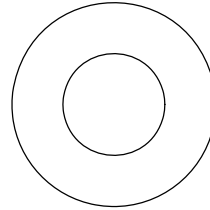

013-0102026
1/2"
FLAT WASHER
LARGE, USS, 34mm

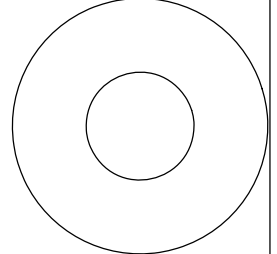

013-0102028
3/8"
CURVED WASHER

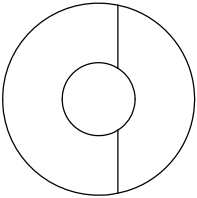

013-0402007
3/8"
FLAT WASHER
22mm O.D.

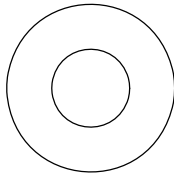

013-0102019
1/4"
LOCK WASHER



013-0102020
3/8"
LOCK WASHER

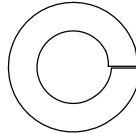

013-0102018
1/2"
LOCK WASHER

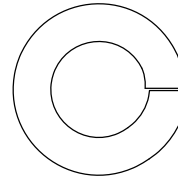

014-0018001
1/2" LONG
SPACER

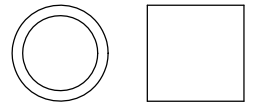

026-01M0238
2" ALUMINUM
FLATHEAD CAP

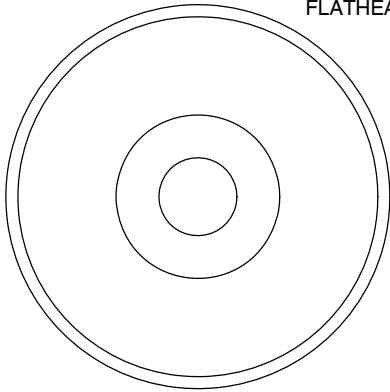

016-0009003
1" SHIM WASHER

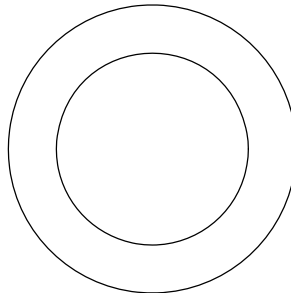

013-0003002
3/8" FENDER WASHER

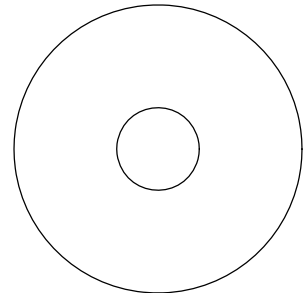

013-0003004
1 1/16"
FENDER WASHER

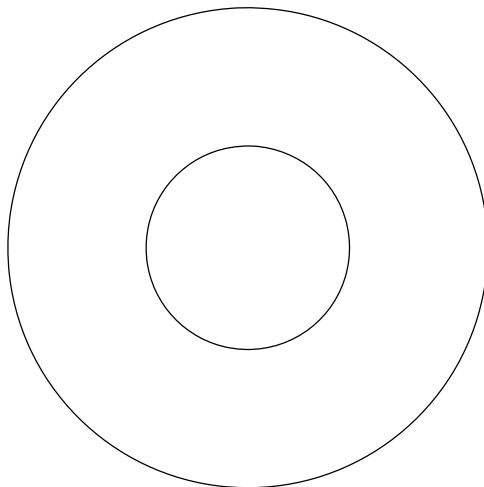

026-01PL151
PLASTIC 1 1/16"
FENDER WASHER

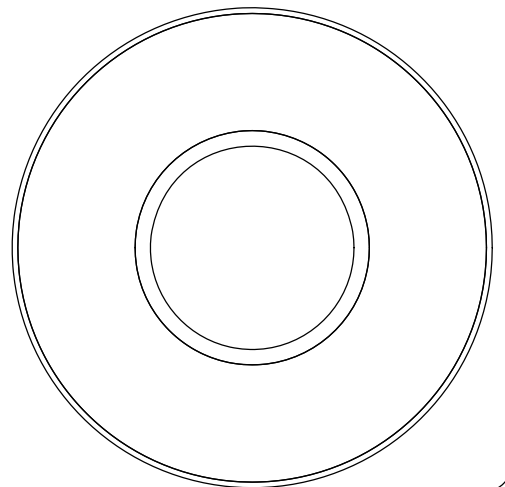

014-0018002
1" LONG
SPACER

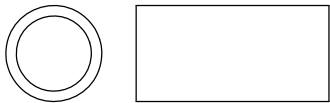

OWNER'S MANUAL

WASHER SIZING CHART (CONTINUED)

026-01M0211
1/4" LONG
FLANGED SPACER

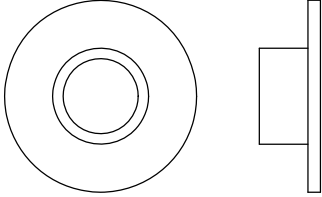

026-01M0198
1/2" LONG
FLANGED SPACER

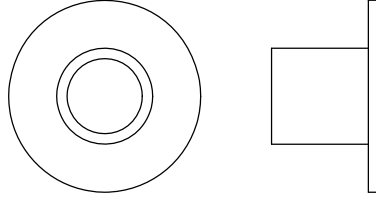

026-01M0760
1/2" LONG HEAVY
FLANGED SPACER

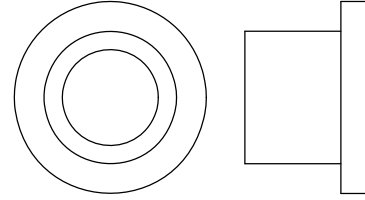

026-01M211T
1/4" LONG HEAVY
FLANGED SPACER

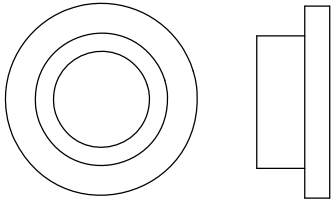

026-01M0532
11/16" LONG HEAVY
FLANGED SPACER

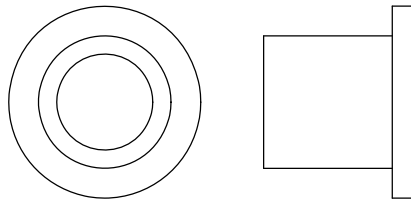

026-01M0551
1" LONG HEAVY
FLANGED SPACER

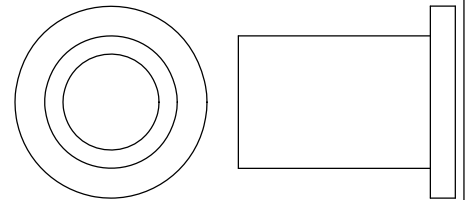

026-01M0788
.81" LONG HEAVY
FLANGED SPACER

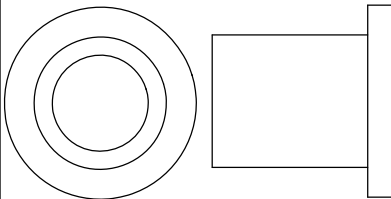

026-01M0780
.65" LONG HEAVY
FLANGED SPACER

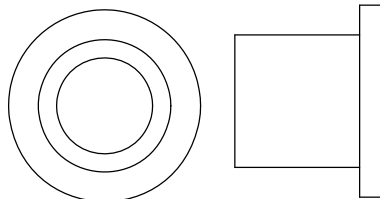

026-01M0761
1 11/16" LONG HEAVY
FLANGED SPACER

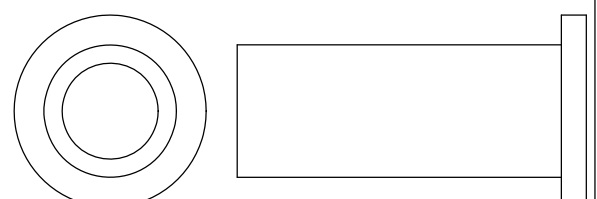

026-01M0789
.44" LONG HEAVY
FLANGED SPACER

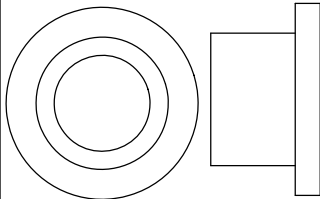

026-01M0762
1 1/2" LONG HEAVY
FLANGED SPACER

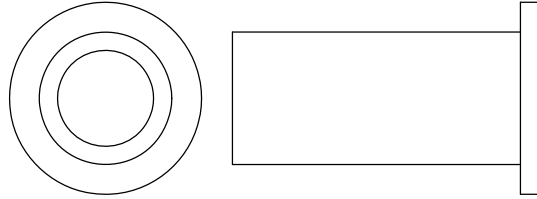

026-01M0768
1 1/4" LONG HEAVY
FLANGED SPACER

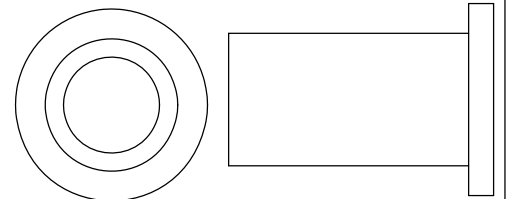

026-01M0600
.625" LONG
FLANGED SPACER

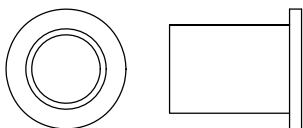

026-01M0240
1 3/8" ALUMINUM
FLATHEAD CAP

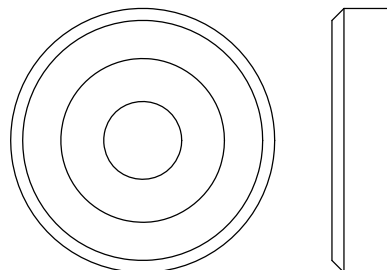

026-01M0239
1 5/8" ALUMINUM
FLATHEAD CAP

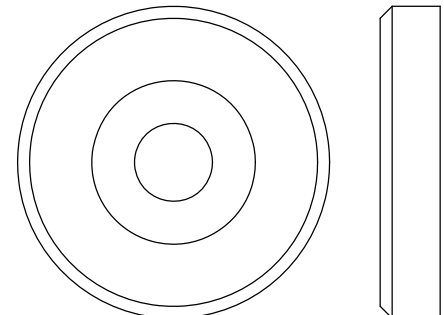

OWNER'S MANUAL

MAINTENANCE SCHEDULE

ROUTINE	COMMERCIAL / LIGHT COMMERCIAL MAINTENANCE	HOME MAINTENANCE	LATEST DATE ENTRY																	
Inspect; Links, Pull Pins, Snap Locks, Swivels, Weight Stack Pins	DAILY	WEEKLY																		
Clean; Upholstery	DAILY	WEEKLY																		
Inspect; Cables or Belts and their tension	DAILY	WEEKLY																		
Inspect; Accessory Bars, and Handles	WEEKLY	3 MONTHS																		
Inspect; All Decals	WEEKLY	3 MONTHS																		
Inspect; All Nuts and Bolts, Tighten if needed	WEEKLY	3 MONTHS																		
Inspect; Anti-Skid Surface	WEEKLY	3 MONTHS																		
Clean & Lubricate; Guide Rods with a Teflon (PTFE) based lubricant (Superlube)	MONTHLY	3 MONTHS																		
Lubricate; Seat Sleeves, Turcite Bushings, Linear Bearing	MONTHLY	3 MONTHS																		
Clean and Wax; All Glossy Finishes	6 MONTHS	YEARLY																		
Repack with Grease; Linear Bearings	6 MONTHS	YEARLY																		
Replace; Cables, Belts and Connecting Parts	YEARLY	3 YEARS																		

*Your equipment comes with a commercial maintenance decal.
For personal, in home use, please follow the home maintenance schedule listed above.*

Never use ammonia, acid-based, or petroleum-based solvents on any portion of the machine as it may damage the finish.

OWNER'S MANUAL

HOIST FITNESS SYSTEMS **GENERAL MAINTENANCE INFORMATION**

Links, Pull-Pins, Snap Hooks, Swivels, Weight Stack Pins:

- *Check all pieces for signs of visible wear or damage.
- *Check springs in snap hooks and pull-pins for proper tension and alignment.
- *If the spring sticks or has lost its rigidity, replace it immediately.

Upholstery:

- *To ensure prolonged upholstery life and proper hygiene, all upholstered pads should be wiped down with a damp cloth after every workout.
- *Periodically take the time to use a mild soap or an approved vinyl upholstery cleaner to deter the onset of cracking or drying. Avoid using any abrasive cleaners or cleaners not intended for use on vinyl.
- *Replace ripped or worn upholstery immediately.
- *Keep sharp or pointed objects clear of all upholstery.

Decals:

- *Inspect and familiarize yourself with any safety warnings or other user information posted on each decal.

Nuts and Bolts:

- *Inspect all nuts and bolts for any loosening and tighten if needed.
- *Go through a re-tightening sequence periodically to ensure that all hardware is tensioned proper.

Anti-Skid Surfaces:

- *These surfaces are designed to supply secure footing and need to be replaced if they appear worn or become slippery.

Belts and Cables:

- *Hoist uses only high quality belt, and mil-spec cables.
- *Visually inspect the belts and cables for fraying, cracking, peeling or discoloration.
- *While the machine is not in use, carefully run your fingers along the belt or cable to feel for thinning or bulging areas.
- *Replace belts and cables immediately at the first signs of damage or wear. Do not use equipment until belts or cables have been replaced.

Belt and Cable Tension:

- *Referring to the Owners Manual, when belts or cables are used check all bolts attachments to be sure they are properly attached.
- *Check slack in cables and re-adjust cable tension if needed.

Seat Sleeves, Guide Rods:

- *Wipe down adjusting tubes with a dust free rag before applying lubricant.
- *Lubricate seat sleeves and Guide Rods with a Silicon or Teflon based lubricant spray.

Linear Bearings:

- *Referring to the Owners Manual carefully disassemble the bearing from its housing and place a finger full of light grease (lithium, super lube, etc.) into the inside of the bearing. Using your finger, press the grease into the ball-bearings and their tracks. repeat until the ball-bearing tracks are full of grease. Insert the shaft back into the bearing and wipe off excess grease.

PLEASE KEEP THIS FOR YOUR RECORDS

OWNER'S MANUAL

WEIGHT TRAINING TIPS

Use this manual to guide you through the basic exercises you can perform on your HF-5165 HOIST® Fitness System. To gain maximum results and avoid possible injury, consult a fitness professional to develop your complete exercise program.

Always consult your physician before starting any exercise program.

To be successful in your exercise program, it is important to develop an understanding of the basic principles of strength training. Now that you have your HF-5165 HOIST® Fitness System, it is only natural that you want to get started immediately. First, determine a set of realistic goals and objectives for yourself. By deciding on an exercise plan that is right for you prior to starting, you will contribute significantly to your success.

Warm up properly before engaging in weight resistance training. Stretching, yoga, jogging, calisthenics or other cardiovascular exercise can help prepare your body for the heavier workload of lifting weights.

Learn how to perform the exercise correctly before using heavy weight. Correct form is important to avoid injury and to ensure that you work the proper muscle groups.

Know your limitations. If you are new to weight training or are embarking on an exercise regimen after a long layoff, start slowly and build foundational strength over a longer period of time.

Pay attention to your breathing. Exhale when you exert is a general rule of thumb. Never hold your breath.

Enjoy your HF-5165 HOIST® Fitness System!

OWNER'S MANUAL

HOIST FITNESS SYSTEMS **LIMITED LIFETIME WARRANTY**

Hoist Fitness Systems warrants this product to the **original purchaser** to be free from defects in workmanship and/or materials under normal use or service. If at any time a component part is defective, Hoist Fitness Systems shall repair or replace it (at Hoist Fitness Systems option) within a reasonable period of time. This warranty does not cover costs of removal, transportation or reinstallation. This warranty shall not apply if the defect was caused by misuse, neglect or normal wear and tear.

WARRANTY CLAIMS. All claims require: Model number, Serial number, Date of installation, and any information supporting the existence of the alleged defect.

To complete Warranty Registration visit:
www.HOISTFITNESS.com
and click on the Warranty Registration link

Starting from the original date of purchase, normal wear and tear shall be considered as the following:

COMMERCIAL USE: All malfunctions of upholstery, grips, and coatings that occur up to one year; all malfunctions of belts, or cables up to one year; all malfunctions of pulleys, bearings, or bushings that occur up to three years. The frame and body components are warranted for ten years, with structural moving parts warranted for five years.

LIGHT COMMERCIAL USE: All malfunctions of upholstery, grips, and coatings that occur up to one year; all malfunctions of belts, or cables up to one year; all malfunctions of pulleys, bearings, or bushings that occur up to three years. The frame and body components are warranted for ten years, with structural moving parts warranted for five years.

HOME USE: All malfunctions of grips, paint, and chrome that occur up to ten years; all malfunctions of electronic components, belts, cables, or upholstery that occur up to ten years; all malfunctions of pulleys, bearings, or bushings that occur up to ten years. The frame and all welded components are warranted for the life of the product.

PLEASE NOTE THAT NOT ALL HOIST PRODUCTS ARE MADE FOR COMMERCIAL USE. Refer to the instructions page of your owners manual or consult with you fitness product dealer to establish if a product is made for commercial use or not. Using a non-commercial product in a commercial setting can result in serious injury or death! Hoist Fitness Systems sole responsibility shall be to repair or replace the component within the terms stated above. Hoist Fitness Systems shall not be liable for any loss or damage of any kind including any incidental or consequential damages resulting, directly or indirectly from any warranty expressed or implied or any other failure of this product.

LIGHT COMMERCIAL USE: Our Light Commercial warranty applies to facilities that **DO NOT** charge monthly membership dues and where the equipment would be used by **no more than 50** people per day. Examples of Light Commercial facilities include hotels, apartment complexes, personal training studios, fire stations, police stations, etc., that meet the criteria stated above.

WHAT IS NOT COVERED BY THIS WARRANTY: Hoist's sole obligation under this warranty is limited to either repair or replacement of parts, subject to the additions below. This warranty neither assumes nor authorizes any person to assume obligations other than expressly covered by this warranty.

NO CONSEQUENTIAL DAMAGES: Hoist is not responsible for economic loss; profit loss; or special, indirect, or consequential damages.

WARRANTY IS NOT TRANSFERABLE: This warranty is not assignable and applies only in favor of the original purchaser/user to whom delivered. Any such assignment or transfer shall void the warranties herein made and shall void all warranties, expressed, implied or statutory, except the one (1) and five (5) year warranties described above. These warranties are exclusive and in lieu of all other warranties, including implied warranty and merchantability or fitness for a particular purpose. There are no warranties which extend beyond the description on the face hereof.

TRANSPORTATION COSTS: Hoist will accept parts covered under this warranty freight collect, provided that shipment has received prior approval. Hoist is not responsible for any other transportation costs, but will ship freight collect parts either repaired or replaced under these warranties.

Hoist Fitness Systems
11900 Community Rd.
Poway, CA. 92064
(800)548-5438

PLEASE KEEP THIS FOR YOUR RECORDS