

3 YEAR
PRODUCT
WARRANTY



UNIMIG® RAZOR 320 AC/DC

KUMJRRW320ACDC | Operating Manual





CONTENTS

SAFETY.....	4
TECHNICAL DATA.....	8
WHAT'S IN THE BOX.....	9
MACHINE LAYOUT.....	10
CONTROL PANEL LAYOUT.....	12
SETUP FOR TIG.....	13
TIG CONTROL PANEL OPERATION.....	16
TIG WELDING GUIDE.....	20
SETUP FOR STICK (MMA) WELDING.....	31
MMA CONTROL PANEL OPERATION.....	34
MMA (STICK) ADDITIONAL NOTES.....	35
MMA (STICK) WELDING GUIDE.....	36
TORCH BREAKDOWN & SPARES.....	38
MACHINE PARTS BREAKDOWN.....	42

Welding and cutting equipment can be dangerous to both the operator and people in or near the surrounding working area if the equipment is not correctly operated. Equipment must only be used under the strict and comprehensive observance of all relevant safety regulations.

Read and understand this instruction manual carefully before the installation and operation of this equipment.

Machine Operating Safety

- Do not switch the function modes while the machine is operating. Switching of the function modes during welding can damage the machine. Damage caused in this manner will not be covered under warranty.
- Disconnect the electrode-holder cable from the machine before switching on the machine, to avoid arcing should the electrode be in contact with the workpiece.
- Operators should be trained and or qualified.



Electric shock: It can kill. Touching live electrical parts can cause fatal shocks or severe burns. The electrode and work circuit is electrically live whenever the output is on. The input power circuit and internal machine circuits are also live when power is on. In MIG/MAG welding, the wire, drive rollers, wire feed housing, and all metal parts touching the welding wire are electrically live. Incorrectly installed or improperly grounded equipment is dangerous.

- Connect the primary input cable, according to Australian and New Zealand standards and regulations.
- Avoid all contact with live electrical parts of the welding/cutting circuit, electrodes and wires with bare hands.
- The operator must wear dry welding gloves while he/she performs the welding/cutting task.
- The operator should keep the workpiece insulated from himself/herself.
- Keep cords dry, free of oil and grease, and protected from hot metal and sparks.
- Frequently inspect input power cable for wear and tear, replace the cable immediately if damaged, bare wiring is dangerous and can kill.
- Do not weld in the rain.
- Do not use damaged, undersized, or badly joined cables.
- Do not drape cables over your body.
- We recommend (RCD) safety switch is used with this equipment to detect any leakage of current to earth.



Fumes and gases are dangerous. Smoke and gas generated while welding or cutting can be harmful to people's health. Welding produces fumes and gases. Breathing these fumes and gases can be hazardous to your health.

- Do not breathe the smoke and gas generated while welding or cutting, keep your head out of the fumes.
- Keep the working area well ventilated, use fume extraction or ventilation to remove welding/cutting fumes and gases.
- In confined or heavy fume environments always wear an approved air-supplied respirator.
- Welding/cutting fumes and gases can displace air and lower the oxygen level, causing injury or death. Be sure the breathing air is safe.
- Do not weld/cut in locations near degreasing, cleaning, or spraying operations. The heat and rays of the arc can react with vapours to form highly toxic and irritating gases.
- Materials such as galvanised, lead, or cadmium plated steel, containing elements that can give off toxic fumes when welded/cut. Do not weld/cut these materials unless the area is very well ventilated, and or wearing an air-supplied respirator.



Arc rays: harmful to people's eyes and skin. Arc rays from the welding/cutting process produce intense visible and invisible ultraviolet and infrared rays that can burn eyes and skin.

- Always wear a welding helmet with the correct shade of filter lens and suitable protective clothing, including welding gloves while the welding/cutting operation is performed.
- Measures should be taken to protect people in or near the surrounding working area. Use protective screens or barriers to protect others from flash, glare and sparks; warn others not to watch the arc.



Fire hazard. Welding/cutting on closed containers, such as tanks, drums, or pipes, can cause them to explode. Flying sparks from the welding/cutting arc, hot workpiece, and hot equipment can cause fires and burns. Accidental contact of the electrode to metal objects can cause sparks, explosion, overheating, or fire. Check and be sure the area is safe before doing any welding/cutting.

- The welding/cutting sparks & spatter may cause fire, therefore remove any flammable materials well away from the working area. Cover flammable materials and containers with approved covers if unable to be moved from the welding/cutting area.
- Do not weld/cut on closed containers such as tanks, drums, or pipes, unless they are correctly prepared according to the required Safety Standards to ensure that flammable or toxic vapours and substances are totally removed, these can cause an explosion even though the vessel has been “cleaned”. Vent hollow castings or containers before heating, cutting or welding. They may explode.
- Do not weld/cut where the atmosphere may contain flammable dust, gas, or liquid vapours (such as petrol)
- Have a fire extinguisher nearby and know how to use it. Be alert that welding/cutting sparks and hot materials from welding/cutting can easily go through small cracks and openings to adjacent areas. Be aware that welding/cutting on a ceiling, floor, bulkhead, or partition can cause a fire on the hidden side.



Gas Cylinders. Shielding gas cylinders contain gas under high pressure. If damaged, a cylinder can explode. Because gas cylinders usually are part of the welding/cutting process, be sure to treat them carefully. CYLINDERS can explode if damaged.

- Protect gas cylinders from excessive heat, mechanical shocks, physical damage, slag, open flames, sparks, and arcs.
- Ensure cylinders are held secure and upright to prevent tipping or falling over.
- Never allow the welding/cutting electrode or earth clamp to touch the gas cylinder, do not drape welding cables over the cylinder.
- Never weld/cut on a pressurised gas cylinder, it will explode and kill you.
- Open the cylinder valve slowly and turn your face away from the cylinder outlet valve and gas regulator.



Gas build-up. The build-up of gas can cause a toxic environment, deplete the oxygen content in the air resulting in death or injury. Many gases use in welding/cutting are invisible and odourless.

- Shut off shielding gas supply when not in use.
- Always ventilate confined spaces or use approved air-supplied respirator.



Electronic magnetic fields. MAGNETIC FIELDS can affect Implanted Medical Devices.

- Wearers of Pacemakers and other Implanted Medical Devices should keep away.
- Implanted Medical Device wearers should consult their doctor and the device manufacturer before going near any electric welding, cutting or heating operation.



Noise can damage hearing. Noise from some processes or equipment can damage hearing.

- Wear approved ear protection if noise level is high.



Hot parts. Items being welded/cut generate and hold high heat and can cause severe burns.

- Do not touch hot parts with bare hands. Allow a cooling period before working on the welding/cutting gun. Use insulated welding gloves and clothing to handle hot parts and prevent burns.

CAUTION

1. Working Environment.

- i. The environment in which this welding/cutting equipment is installed must be free of grinding dust, corrosive chemicals, flammable gas or materials etc., and at no more than a maximum of 80% humidity.
- ii. When using the machine outdoors, protect the machine from direct sunlight, rainwater and snow, etc.; the temperature of the working environment should be maintained within -10°C to +40°C.
- iii. Keep this equipment 30cm distant from the wall.
- iv. Ensure the working environment is well ventilated.

2. Safety Tips.

- i. **Ventilation:** This equipment is small-sized, compact in structure, and of excellent performance in amperage output. The fan is used to dissipate heat generated by this equipment during the welding/cutting operation. Important: Maintain good ventilation of the louvres of this equipment. The minimum distance between this equipment and any other objects in or near the working area should be 30 cm. Good ventilation is of critical importance for the normal performance and service life of this equipment.
- ii. **Thermal Overload Protection:** Should the machine be used to an excessive level, or in a high-temperature environment, poorly ventilated area or if the fan malfunctions the Thermal Overload Switch will be activated, and the machine will cease to operate. Under this circumstance, leave the machine switched on to keep the built-in fan working to bring down the temperature inside the equipment. The machine will be ready for use again when the internal temperature reaches a safe level.
- iii. **Over-Voltage Supply:** Regarding the power supply voltage range of the machine, please refer to the “Main parameter” table. This equipment is of automatic voltage compensation, which enables the maintaining of the voltage range within the given range. In case that the voltage of input power supply amperage exceeds the stipulated value, it is possible to cause damage to the components of this equipment. Please ensure your primary power supply is correct.
- iv. Do not come into contact with the output terminals while the machine is in operation. An electric shock may occur.

MAINTENANCE

Exposure to extremely dusty, damp, or corrosive air is damaging to the welding/cutting machine. To prevent any possible failure or fault of this welding/cutting equipment, clean the dust at regular intervals with clean and dry compressed air of required pressure.

Please note that: lack of maintenance can result in the cancellation of the guarantee; the guarantee of this welding/cutting equipment will be void if the machine has been modified, attempt to take apart the machine or open the factory-made sealing of the machine without the consent of an authorized representative of the manufacturer.

TROUBLESHOOTING

Caution: Only qualified technicians are authorized to undertake the repair of this welding/cutting equipment. For your safety and to avoid Electrical Shock, please observe all safety notes and precautions detailed in this manual.

ATTENTION! - CHECK FOR GAS LEAKAGE

At initial set up and at regular intervals we recommend to check for gas leakage

Recommended procedure is as follows:

- 1.** Connect the regulator and gas hose assembly and tighten all connectors and clamps.
- 2.** Slowly open the cylinder valve.
- 3.** Set the flow rate on the regulator to approximately 8-10 L/min.
- 4.** Close the cylinder valve and pay attention to the needle indicator of the contents pressure gauge on the regulator, if the needle drops away towards zero there is a gas leak. Sometimes a gas leak can be slow and to identify it will require leaving the gas pressure in the regulator and line for an extended time period. In this situation it is recommended to open the cylinder valve, set the flow rate to 8-10 L/min, close the cylinder valve and check after a minimum of 15 minutes.
- 5.** If there is a gas loss then check all connectors and clamps for leakage by brushing or spraying with soapy water, bubbles will appear at the leakage point.
- 6.** Tighten clamps or fittings to eliminate gas leakage.

IMPORTANT! - We strongly recommend that you check for gas leakage prior to operation of your machine. We recommend that you close the cylinder valve when the machine is not in use.

Welding Guns Of Australia PTY LTD, authorised representatives or agents of Welding Guns Of Australia PTY LTD will not be liable or responsible for the loss of any gas.

RAZOR™ 320 AC/DC TIG/STICK Welder

Key Features:

- AC/DC High-Frequency TIG
- Pulse TIG Function
- AC TIG Waveforms
- Square, Trapezoidal, Sine
- Mixed Arc AC/DC
- Foot Control Ready
- 2T/4T Torch Modes
- Remote Control Module

3 YEAR
PRODUCT
WARRANTY



TECHNICAL DATA

SKU	KUMJRRW320ACDC
PRIMARY INPUT VOLTAGE	415V Three Phase
SUPPLY PLUG	No plug supplied (20 AMP Recommended)
RATED INPUT POWER (kVA)	9.0
I _{eff} (A)	10
RATED OUTPUT	5-320A
NO LOAD VOLTAGE (V)	9-73
PROTECTION CLASS	IP21S
INSULATION CLASS	F
POWER FACTOR	0.7
MINIMUM GENERATOR (kVA)	10.0
DINSE CONNECTOR	35/50
STANDARD	AS/NZ60974-1, AS/NZ60974-10
WELDS	Mild Steel, Stainless Steel, Cast Iron, Silicon Bronze, Copper, Aluminium, Zinc Alloys
WARRANTY (Years)	3

TIG SPECIFICATIONS

TIG FUNCTION TYPE	AC/DC HF TIG & AC/DC Pulse, Lift Arc Ignition
TIG WELDING CURRENT RANGE	5-315A
TIG DUTY CYCLE @ 40°C	30% @ 320A
TIG WELDING THICKNESS RANGE	1-16mm

AC TIG SETTINGS

AC WAVE FREQUENCY	50-200Hz (5-200A) 50-100Hz (200-320A)
AC PULSE FREQUENCY	0.5-20Hz (5-200A) 0.5-10Hz (200-320A)
PULSE WIDTH CONTROL	5-95%
AC WAVE FORMS	Square, Trapezoidal, Sine

DC TIG SETTINGS

DC PULSE FREQUENCY 0.5-200Hz (5-320A)

MIX ARC TIG SETTINGS

AC/DC MIX CYCLE 5-95% DC

AC WAVE FREQUENCY 50-100Hz

MIX PULSE FREQUENCY 1-10Hz

STICK SPECIFICATIONS

STICK WELDING CURRENT RANGE 10-270A

STICK DUTY CYCLE @ 40°C 30% @ 270A

STICK ELECTRODE RANGE 2.5-5.0mm

STICK WELDING THICKNESS RANGE 2-16mm

ARC FORCE 0-40

IGNITION TIME 0.01-1.50s

SIZE & WEIGHT

DIMENSIONS (mm) 566x223.5x405mm

WEIGHT (kg) 25.5kg

MACHINE FEATURES

VRD	Yes
FOOT CONTROL CONNECTION	Yes (UTJCF-4)
CRATER CURRENT CONTROL	Yes
THERMAL OVERLOAD PROTECTION	Over Temperature Warning

WHAT'S IN THE BOX

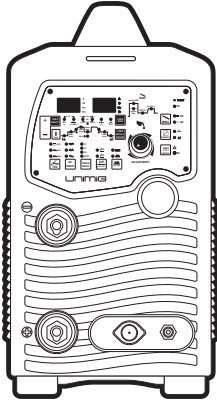

RAZOR 320 AC/DC TIG/STICK Welder

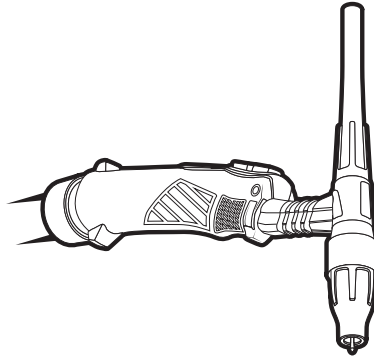

4m T3 TIG Torch

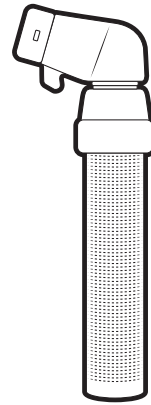

4m Electrode Holder

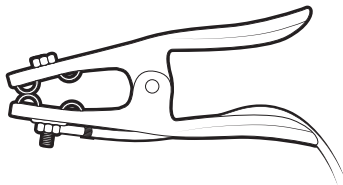

4m 500 AMP Earth Clamp

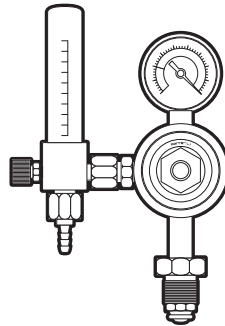

Argon Flowmeter Regulator



Operating Manual

Optional Accessories

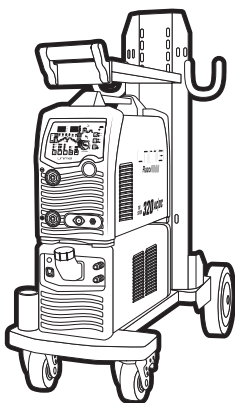

**RAZOR 320 AC/DC
WATER COOLER TROLLEY**

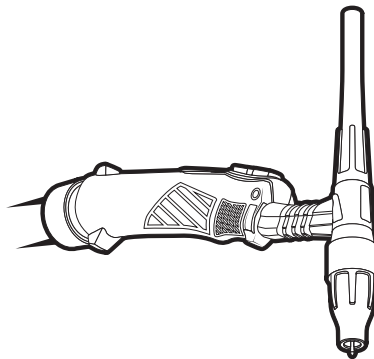

4m T3W Water Cooled TIG Torch

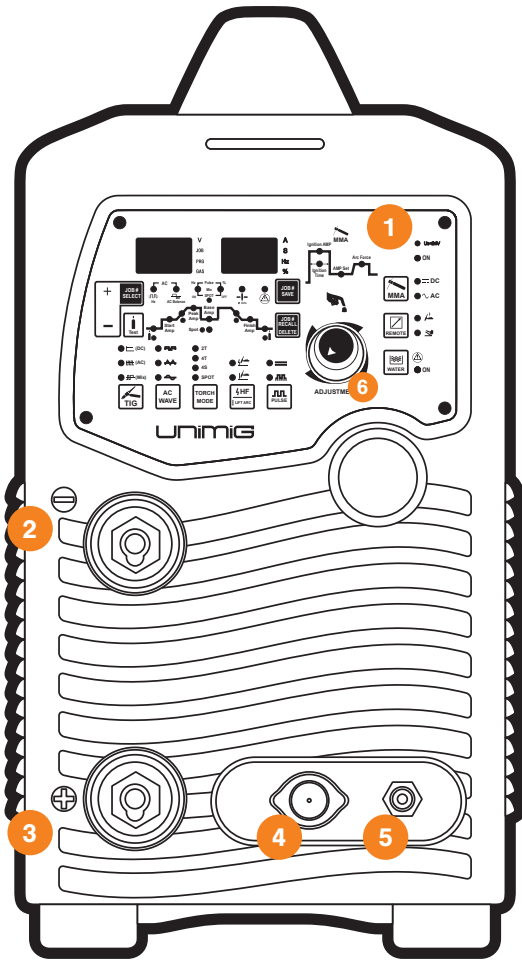

Front Panel Layout

1. Digital control panel
2. Negative output terminal
3. Positive output terminal
4. Torch switch - Remote connector
5. Quick lock gas connector
6. Adjustment Knob

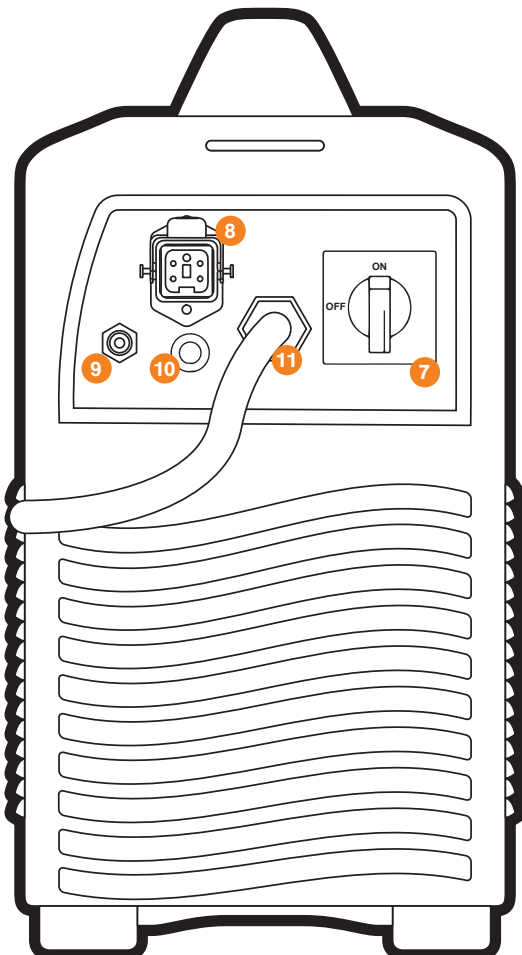

Rear Panel Layout

7. Power switch - on/off
8. Water Cooler Connector
9. Inlet gas connector
10. Water Cooler Fuse
11. Mains Power Cable

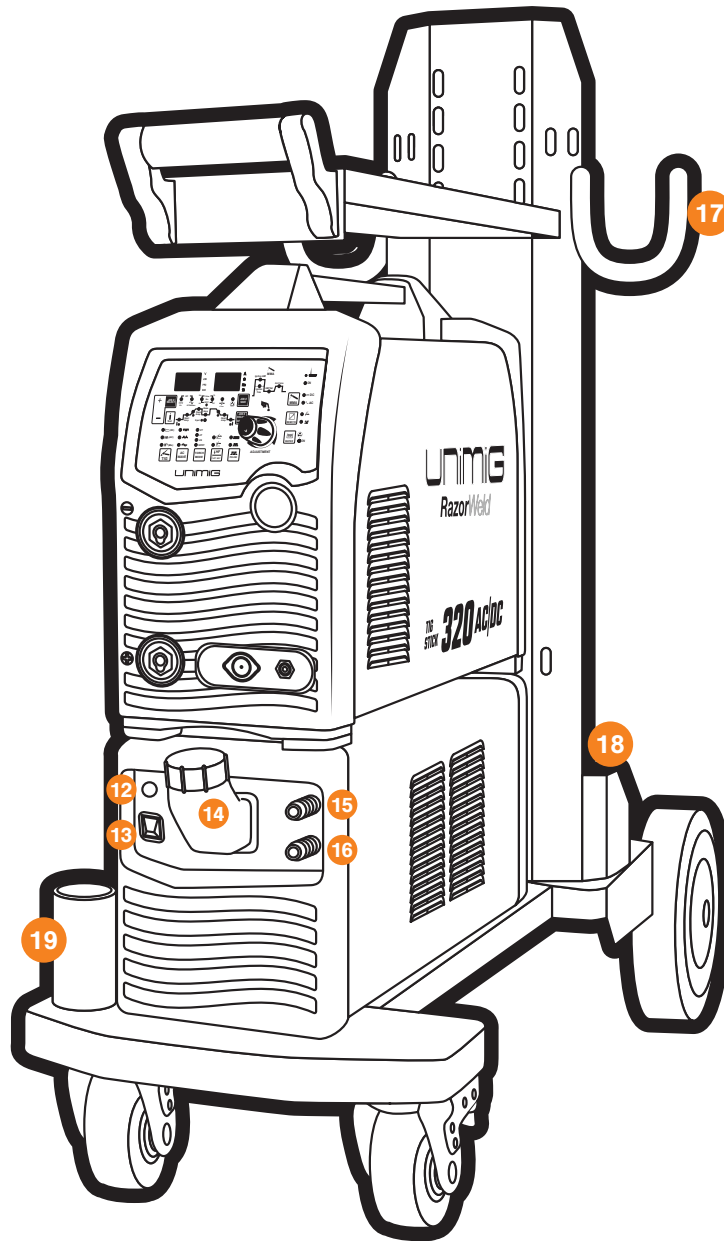

Water Cooler Layout

- 12. Fault Alarm
- 13. On/Off Switch
- 14. Coolant Filler
- 15. Water Connector Inlet (Red)
- 16. Water Connector Outlet (Blue)
- 17. Cable Hanger
- 18. Cylinder Tray
- 19. Tig Rod Holder

CONTROL PANEL LAYOUT

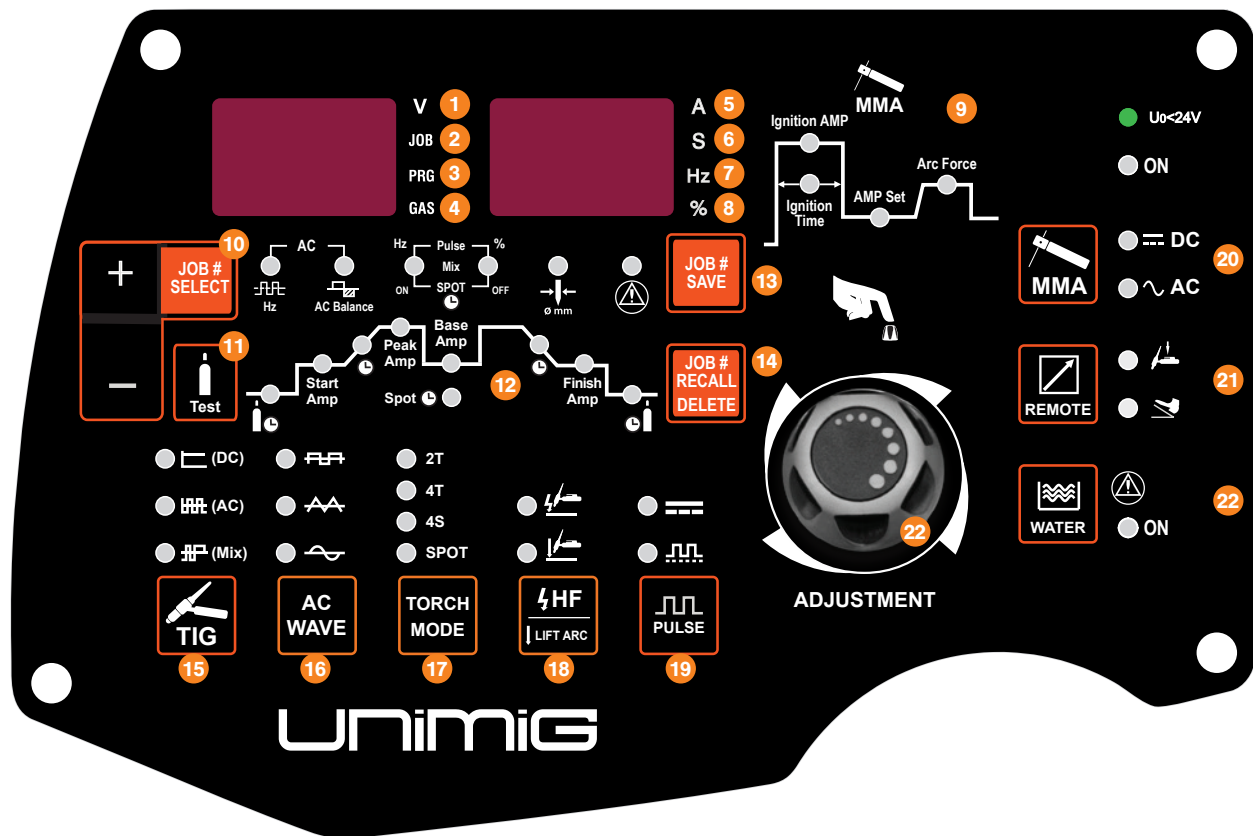

Control Panel Layout

- | | |
|---------------------------|------------------------------|
| 1. Voltage Value | 13. Job Save |
| 2. Job Number | 14. Job Recall / Job Delete |
| 3. Program Status | 15. TIG Mode Selector |
| 4. Gas Flow Status | 16. TIG AC Waveform Selector |
| 5. Amperage Value | 17. TIG Torch Mode Selector |
| 6. Seconds Value | 18. TIG Ignition Selector |
| 7. Frequency Value | 19. TIG Pulse Selector |
| 8. Percentage Value | 20. MMA Mode Selector |
| 9. MMA (STICK) Controls | 21. Remote Mode Selector |
| 10. Job Select | 22. Water Cooler Selector |
| 11. Gas Test | 23. Adjustment Knob |
| 12. Weld Sequence Control | |

SETUP FOR TIG

- 1 Connect the TIG torch to the **negative (-)** dinse connection, twist to lock in place.

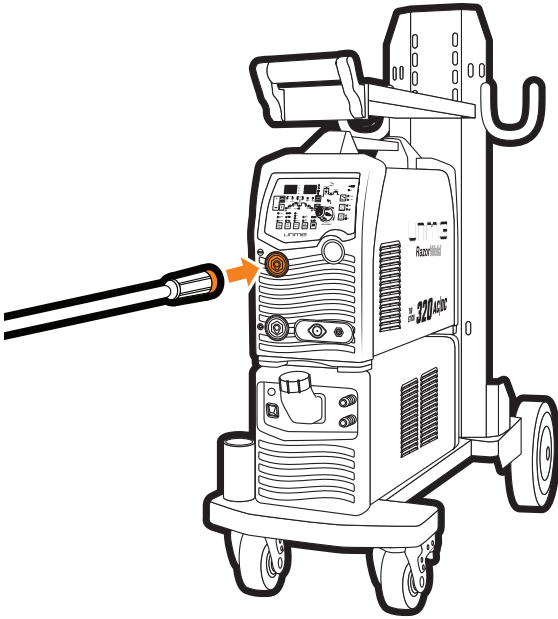

- 2 Connect the earth clamp to the **positive (-)** dinse connection, twist to lock in place.

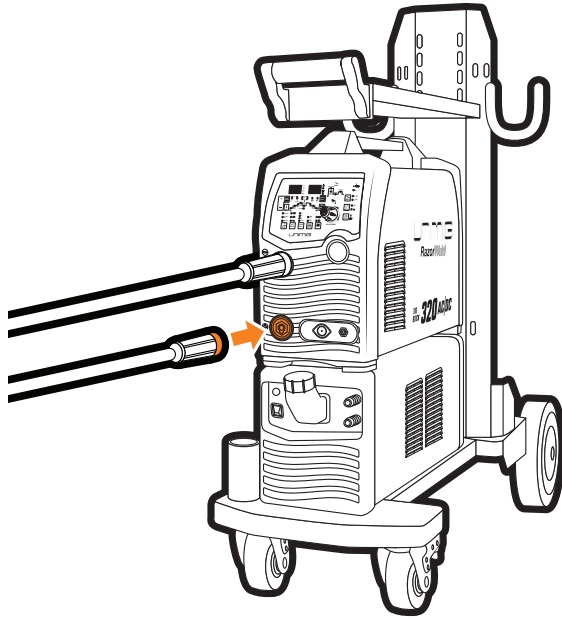

- 3 Place argon flowmeter regulator into your gas outlet.

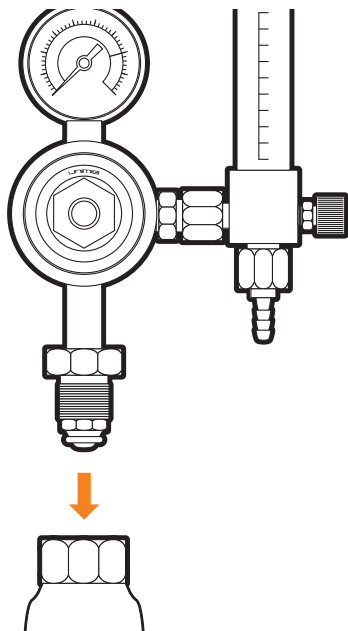

- 4 Tighten securely with wrench.

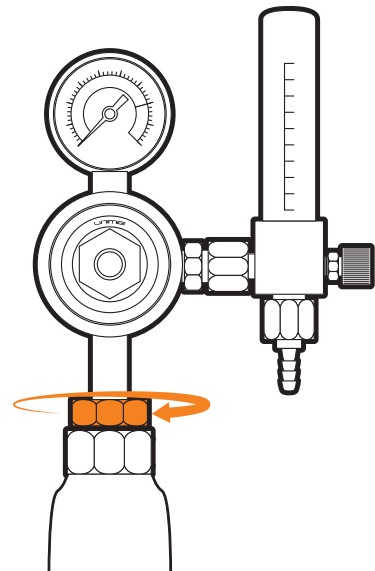

SETUP FOR TIG

- 5 Connect gas hose to the flowmeter outlet, and crimp in place.

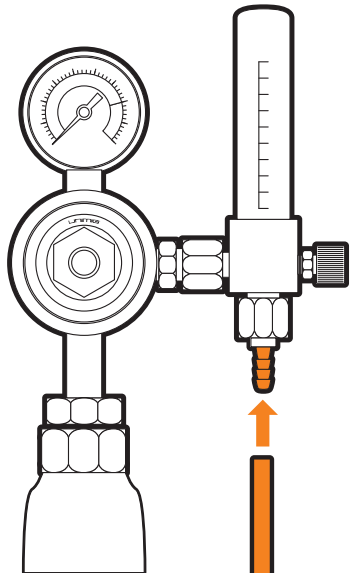

- 6 Adjust gas glow to 6-10L/min.

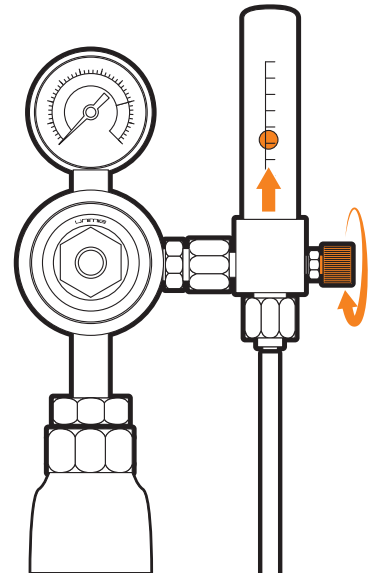

- 7 Set parameters according to TIG Control Panel Operation (Page 16).

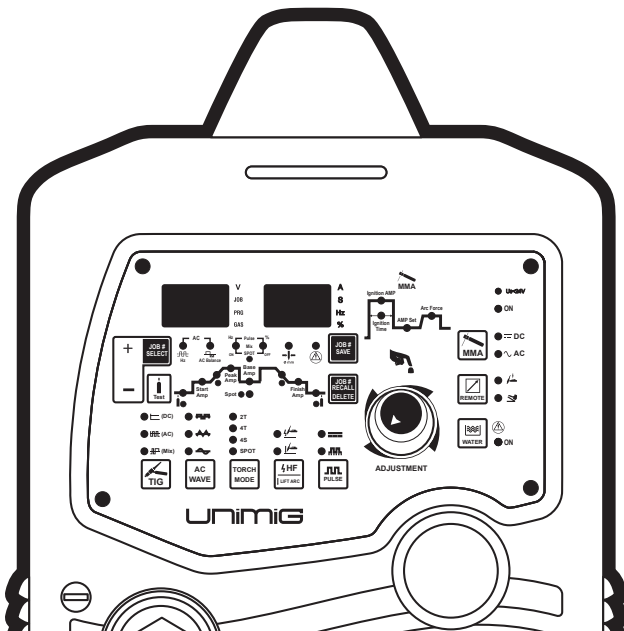

- 8 Connect earth clamp to your workpiece.

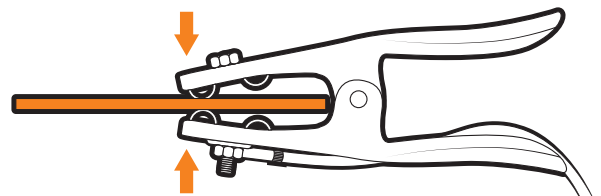

SETUP FOR LIFT ARC TIG

- 9 Initiate arc by pressing the button on the TIG Torch.

10

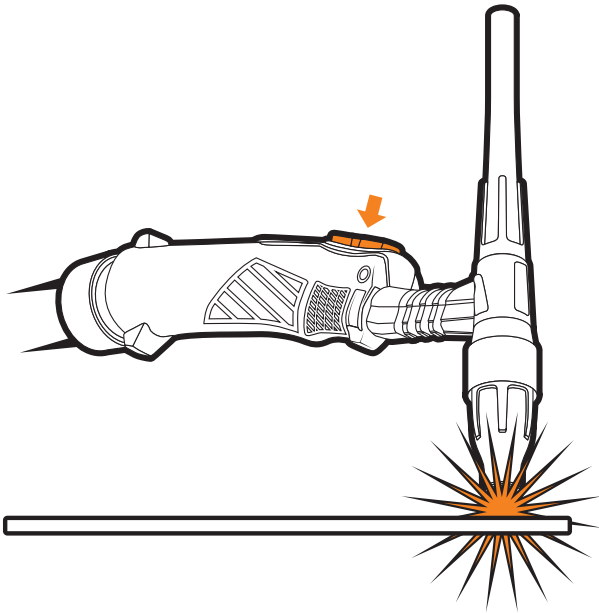

IMPORTANT! - We strongly recommend that you check for gas leakage prior to operation of your machine. We recommend that you close the cylinder valve when the machine is not in use.

Welding Guns Of Australia PTY LTD, authorised representatives or agents of Welding Guns Of Australia PTY LTD will not be liable or responsible for the loss of any gas.

TIG CONTROL PANEL OPERATION



Adjustment Knob

Provides digital adjustment of welding parameters and provides step by step motion through the weld cycle parameters.

- **Turn the knob** to increase or decrease the desired value displayed on the LED display.
- **Press the knob** to cycle between each step of the weld cycle.



TIG Mode Selector

Enables selection of required welding mode:

- **DC**
- **AC**
- **Mix Arc**

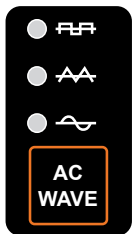

AC Wave Form Selector

Enables selection of AC Wave Form:

- **Square**
- **Trapezoidal**
- **Sine**

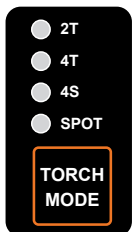

TIG Torch Mode Selector

Controls the on/off cycle of the machine using the torch switch while incorporating the weld program parameters selections:

- **2T** uses 2 actions of the torch switch while incorporating the weld program parameter selections.
- **4T** uses 4 actions of the torch switch while incorporating the weld program parameter selections. 4T provides operator control of the start and finish portions of the weld sequence.
- **4S???**
- **Spot** uses a single action of the torch switch. Pressing the torch switch gives arc ignition and initialises the welding sequence for the period of time set using the spot timer.



TIG Ignition Selector

Enables selection of Arc Ignition:

- **High Frequency**
- **Lift Arc**



TIG Pulse Selector

Enables selection of TIG Pulse:

- **Pulse OFF**
- **Pulse ON**

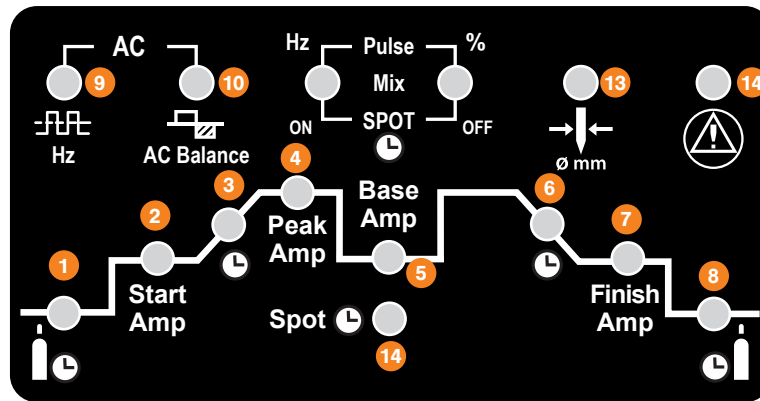

1. Pre Gas Timer

Provides selection for gas flow time prior to the arc starting (0.5-10s).

2. Start Amp

Provides selection for the amount of amperage required at the start of the weld (10-320A).

3. Up Slope Time

Sets the transition time from Start Amperage to Welding Amperage (0-15s).

4. Peak Amp

Provides selection for the Maximum Welding Amperage required during welding (10-320A).

5. Base Amp

Provides selection for the Base Amperage during the Pulse Welding cycle (5-320A).

6. Down Slope Time

Sets the transition time from Welding Amperage to Finish Amperage (0-15s).

7. Finish Amp

Provides selection for the amount of amperage required at the end of the weld (10-320A).

8. Post Gas Timer

Provides selection for continued gas flow time at the end of the welding after the arc is out (0.5-15s).

9. AC Hertz

Provides selection to adjust the frequency of the AC square wave in AC TIG mode. Allows adjustment of frequency of the AC square wave cycle. The number of times per second (Hz) the arc switches from + to – polarity (AC) during AC TIG welding (50-200Hz).

10. AC Balance

Provides balance adjustment of the AC wave form in AC TIG mode. Allows adjustment of the proportion of polarity from balanced, to more – polarity for penetrating action or more + for oxide cleaning action during AC TIG welding (-5 to +5).

11. Tungsten Diameter

Provides selection of the correct tungsten diameter for the set welding parameters (1.0-4.0mm).

Warning Alert (14) appears if the parameters are outside the capability of the tungsten diameter.

TIG CONTROL PANEL OPERATION

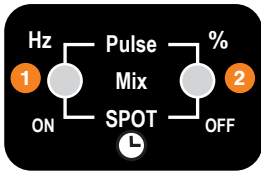

PULSE MODE

1. Pulse Hz

Provides selection and adjustment of the pulse frequency of the output welding current. Allows adjustment of frequency that the output current transitions from Peak Amp to Base Amp.

- Range DC (0.5-200Hz)
- Range AC (0.5-20Hz)

2. % Pulse

Provides selection of the on time ratio of the Peak Amp during the pulse welding cycle (Pulse Width). Allows adjustment of the % of time that the Peak Amp is on during each pulse cycle (5-95%).

MIX ARC MODE

1. Mix Hz

Provides selection and adjustment of the frequency of AC output to DC- output during MIX ARC welding. Adjusts the frequency Hz (times per second) that the output current switches from AC to DC- (1-10Hz).

2. Mix %

Provides selection and adjustment of the % of DC- output during the MIX ARC welding cycle. Adjusts the amount of DC- output during MIX ARC welding (5-95%).

SPOT MODE

Selecting SPOT mode allows setting of an ON time and OFF time of the welding current. After pressing the torch switch and generating an established arc the welding current will stay on for the amount of ON TIME, (set in the SPOT weld program) the arc will go out after the set amount has passed. Keeping the torch switch depressed will allow an OFF TIME (interval) (set in the SPOT weld program) period before the arc is re-established and the welding current stays on again for the set amount of ON TIME, the cycle will repeat until the torch switch is released.

1. Spot On Time

Provides selection and adjustment of the ON TIME of the weld during SPOT Weld cycle. Adjusts the amount of time the welding output stays on after arc ignition (0.01-1.00s).

2. Spot Off Time

Provides selection and adjustment of the OFF TIME of the weld during SPOT Weld cycle. Adjusts the amount of the OFF time interval of the welding current (0.1-5.0s).

TIG CONTROL PANEL OPERATION

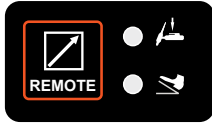

Remote Mode Selector

Provides selection selection of the type of Remote Control to be use as required, including remote torch potentiometers and foot controls.

- **Torch Ignition**
- **Remote Foot Pedal / Torch Ignition**

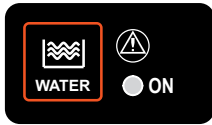

Water Cooler Mode

Provides electronic link when water cooler unit is connected to the machine

- Press button to turn **ON / OFF**

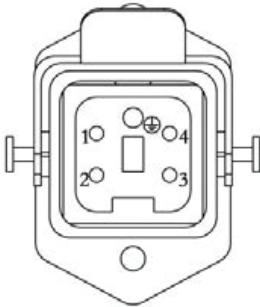

Water Cooler Connection

The water cooler is connected to the power source via a 5 Pin connector located at the rear of the machine. The connector provides 220-230VAC power supply to the water cooler unit via Pins 1&2. The machine will monitor the water flow and welding off time via a signal circuit connected to Pins 3&4.

NOTE: This sensor circuit will turn off the welding output should there be no or insufficient water flow from the water cooler unit. This will prevent the Water Cooled torch cable from over heating and burning out.

When using RAZOR 320 AC/DC machine with a Water Cooled TIG Torch ensure:

1. The water cooler is plugged into the power supply at the rear of the Power Source.
2. The water level is to the full level.
3. The water cooler is switched on using the on/off switch located on the front panel of the water cooler.
4. The power source is in Water Cooler Mode by selecting the Water On icon on the front panel.



Saved JOB System

Allows the operator to save the set welding parameters and assign them to a JOB number. The JOB number can be recalled later as required, the welding parameters are preserved inside the JOB number ready for use.

1. JOB SELECT

Use the **JOB SELECT (+)** and **TEST (-)** buttons to cycle through the JOB numbers.

2. JOB SAVE

Press the **JOB SAVE** button to save the current settings to the selected JOB number.

3. JOB RECALL

Select the desired JOB NUMBER, then press the **JOB RECALL** button to load saved settings.

4. JOB DELETE

Select the desired JOB NUMBER, then hold the **JOB RECALL** button for 2s to delete saved settings.



GAS TEST

Press the **GAS TEST** button to initiate a gas test. After 20s the test will end, you can also end the test by pressing the **GAS TEST** button again.

TIG WELDING GUIDE

AC WAVE FORMS

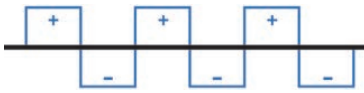

AC Square Wave: Allows the current to change from electrode + positive to electrode - negative very quickly. This produces high voltage as the current switches polarities allowing the arc to re-start easily. The arc can be maintained without the use of high-frequency and the fast transitions provide for responsive, dynamic and focused arc for better directional control.

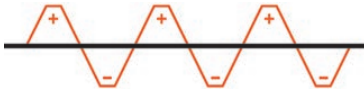

AC Triangle Wave: Characterised by a particularly soft and concentrated arc combining the effect of peak amperage while reducing overall heat input. Leads to quick puddle formation and, because of lowered heat input, reduced weld distortion, especially on thin material. This wave form is ideal for very precise welding of thin Aluminum plate.

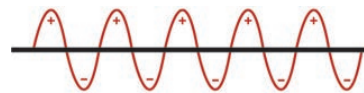

AC Sine Wave: It is the standard Wave form, characterised by low noise and excellent arc control, it also gives the soft-arc feel of a conventional power source, while using square transitions to eliminate the need for continuous HF.

AC WAVE FORM FREQUENCY CONTROL

It is possible with the RAZOR320ACDC machine to adjust the frequency of the AC Square Wave output. It means that the amount of time that it takes the AC square wave to complete a full cycle switch from positive (+) to negative (-) can be adjusted from 20Hz (20 times per second) to 200Hz

Increasing frequency (Hz) causes the current to change direction more often, which means that it spends less time per cycle in both DC electrode negative and DC electrode positive mode. By spending less time at each polarity, the arc cone has less time to expand.

A higher frequency produces a narrower arc cone producing an arc that is tighter with more focus at the exact spot the electrode is pointing. The result is improved arc stability, ideal for fillet welds and other fit ups requiring precise penetration. Decreasing the frequency softens the arc and broadens the weld pool producing a wider bead, produces good overall penetration and ideal for build up applications.

AC Square Wave Hz

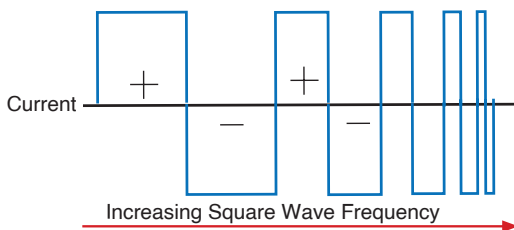

Slower AC Square Wave Hz

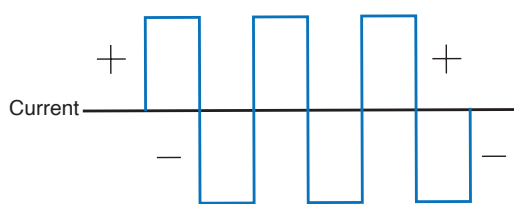

Faster AC Square Wave Hz

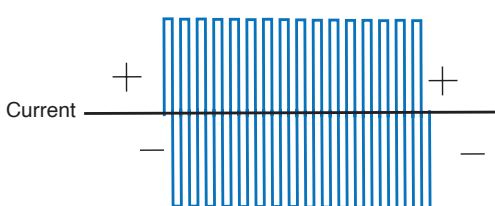

Slower AC Square Wave Hz

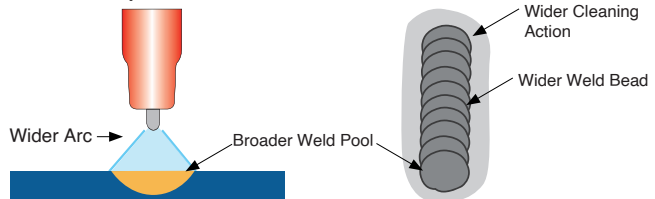

Faster AC Square Wave Hz

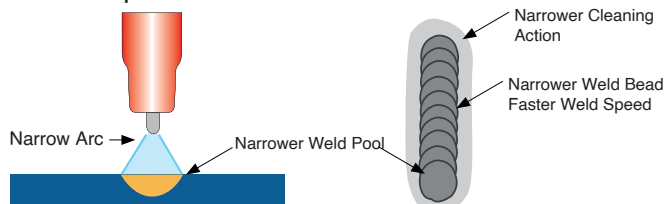

AC (alternating current) enables us to TIG weld non ferrous alloys like Aluminium, Magnesium and Aluminium Alloys. These materials have an insulating surface oxide layer that melts at a higher temperature than the base metal making it difficult to weld the base metal if the oxides are not removed. AC welding current is ideal because the nature of the AC wave form assists in breaking the surface oxide layer.

AC (alternating current) has a current cycle that flows from + (direct) polarity to - (reverse) polarity.

The reversing of the polarity breaks the surface oxide while the direct polarity melts the base material.

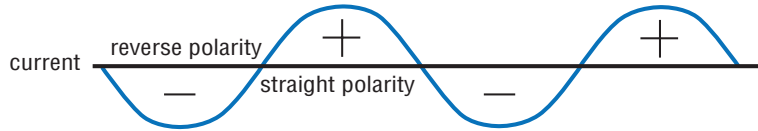

There are inherent problems that come with AC TIG arc rectification, arc stutter, arc wandering and arc stoppage. These problems typically occur during the transition between + and - cycles.

The current is lesser (30%) during the half of the cycle when the electrode is positive and there is a resistance of the electron flow during this half cycle (rectification). The lack of current flow during this half cycle makes the AC arc unstable.

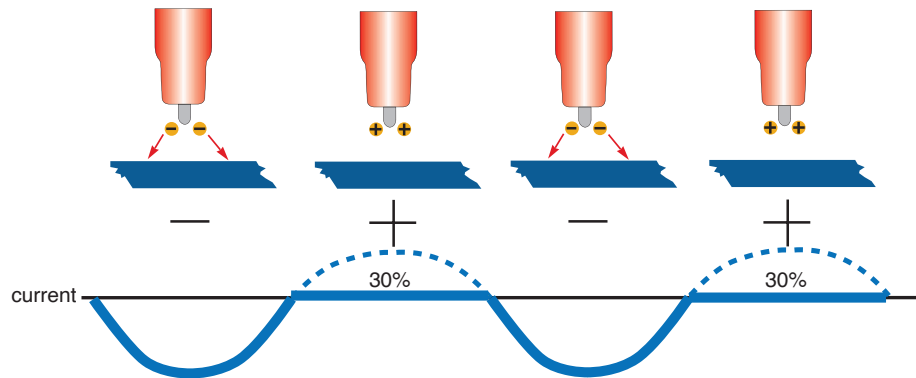

To overcome this lack of flow during one half of the cycle, a high-frequency (HF) voltage is generated and fed into the welding circuit. The HF maintains the arc stability during the half cycle when the electrode is positive.

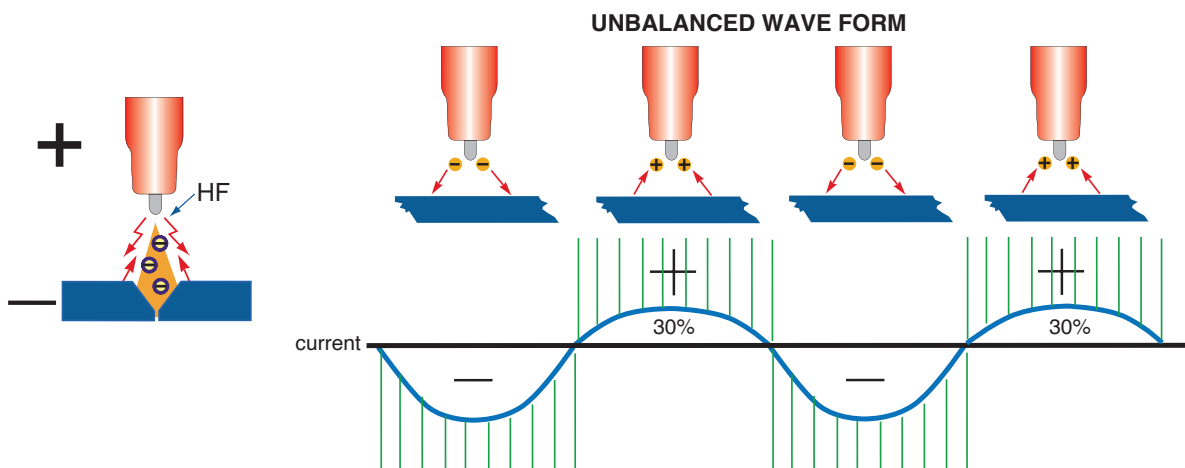

High-frequency voltage flows continually in the welding circuit and keeps the shielding arc in the welding area in an ionized state. When the arc is ionized the arc is maintained during the half of the cycle when the electrode is positive. However while the arc is maintained less current flows during this half of the AC cycle, producing an unbalanced wave.

TIG WELDING GUIDE

In older machines, a balanced current output wave was achieved using a large number of capacitors in series or a battery in the welding circuit. Modern TIG power sources use electronics to create and maintain a balanced wave and now most AC TIG power sources produce a square wave current output.

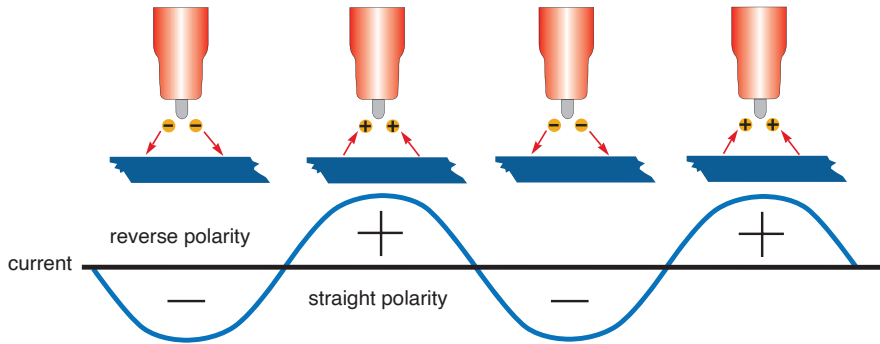

A square wave power supply can change the current from electrode + positive to electrode - negative very quickly. This produces high voltage as the current switches polarities allowing the arc to restart easily. The arc can be maintained without the use of high-frequency or any other arc stabilising methods.

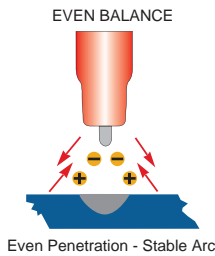

BALANCED SQUARE WAVE FORM

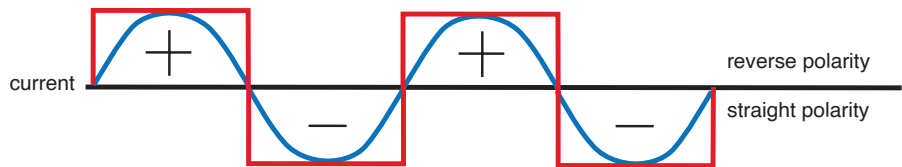

The output current and voltage are controlled electronically so the balance between the amount of current electrode positive and the amount of current electrode negative can be adjusted. This allows the welder to adjust the amount of cleaning and the amount of penetration. This is achieved electronically by adjusting the balance control dial on the welding machine. More current flow from the + polarity produces stronger arc energy and current flow from the tungsten and is good for removing the oxidized surface of the work piece. However too much + current flow can drive too much energy to the tungsten causing it to overheat and melt the tungsten electrode.

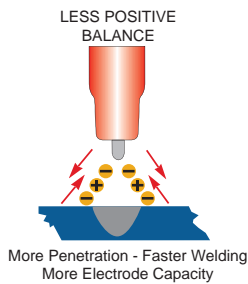

Balance Adjusted for More Penetration - Cooler Tungsten

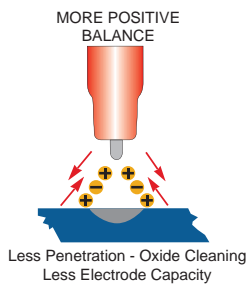
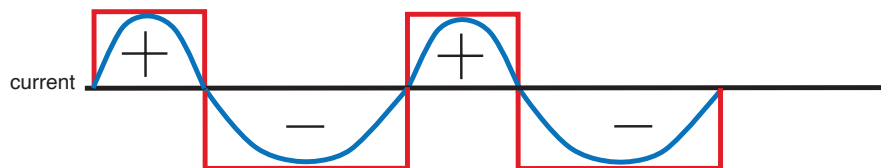

Balance Adjusted for More Oxide Cleansing Action - Hotter Tungsten

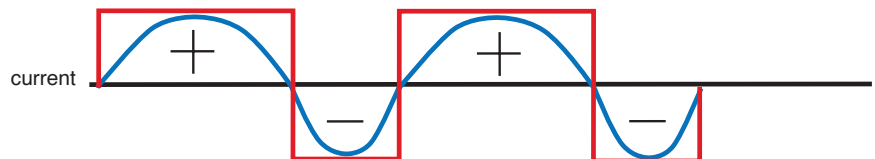

AC Pulse Welding Set Up Procedure

EXAMPLE OF PULSE AC TIG WELDING - SETUP PARAMETERS:

Material = Aluminium x 3.0mm / Tungsten Electrode = 2.4mm Zirconiated / Gas = Argon

The following steps are a guide as a starting point for you to set the machine up in Pulse mode to give an example of welding in Pulse mode function. You can experiment by changing any of the variables to see what effect it has over the welding and what the end result can be, but it is suggested to change only one variable at a time and then check the welding to see what the result is, in this way you acquire a better understanding of how each variable affects the welding current.

1. Select Pulse Mode



Select **Pulse** welding mode by pushing the **PULSE** button to select and illuminate the pulse icon.

Selecting Pulse Parameters

Select pulse parameters by turning the encoder to cycle through the front panel to select the pulse parameter icons and make settings as shown in the following step by step procedure.

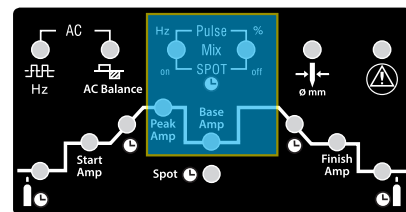

2. Select Peak Amperage

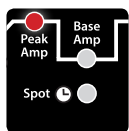

Peak Amp: Select by turning the encoder to cycle through to illuminate the **Peak Amp** icon.



Push the Encoder to lock the icon ready for adjustment.



Turn the Encoder to set the Peak Amperage



The setting shows on the digital display.

3. Select Base Amperage

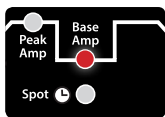

Base Amp: Turn the encoder to cycle through to illuminate the **Base Amp** icon.



Push the Encoder to lock the icon ready for adjustment.



Turn the Encoder to set the Base Amperage



The setting shows on the digital display.

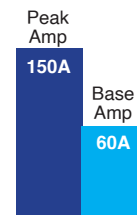

4. Select Pulse Frequency Hz

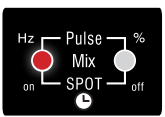

Pulse Hz: Turn the encoder to cycle through to illuminate the **Hz** icon.



Push the Encoder to lock the icon ready for adjustment.



Turn the Encoder to set the Base Amperage



The value selected is the number of times the current switches from Peak Amp to Base Amp per second

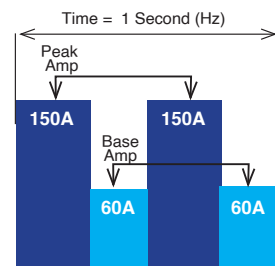

5. Select Pulse Width

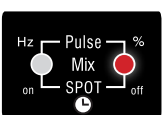

Pulse %: Turn the encoder to cycle through to illuminate the **Pulse %** icon.



Push the Encoder to lock the icon ready for adjustment.



Turn the Encoder to set the Base Amperage



The value selected is the % of time the Peak Amp is on during each pulse cycle.

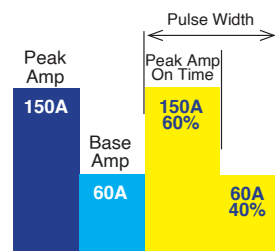

MIX ARC WELDING

MIX Arc is an innovative welding solution for high current AC welding applications. This function of MIX AC/DC makes it possible to modulate the welding current, alternating a period of TIG AC with a period of TIG DC-. This means that the efficiency of AC TIG welding can be combined with the high penetration of DC TIG welding, obtaining higher welding speeds, establishing the weld puddle quicker on cold workpieces, increase weld penetration and reduces tungsten tip temperature. Other benefits are the welding of extremely diverse material thickness eg., 1mm to 10mm and helping bridge and close gaps between two joints during welding.

The result in welding is similar to AC PULSE welding but with a stronger arc force in the molten pool making it particularly suitable for welding thicker material.

During the AC period of the arc the oxide film is broken, the welding arc becomes wider and the surface impurities are flushed out. During the DC period of the arc the arc becomes narrower, the molten pool is drawn deeper into the workpiece improving penetration.

The operator adjustable parameter is the percentage of AC waveform compared to DC- waveform, which can be varied from 5-95%. It is good practice never to exceed the value of 50% DC - waveform, which would otherwise impair the oxide removal and flushing portion of the weld and effect the appearance of the weld bead.

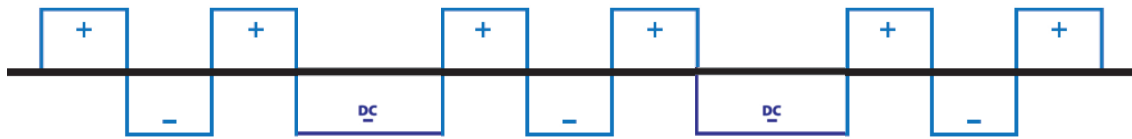

MIX ARC can be used with the different AC wave forms of Square Wave, Triangle Wave and Sinusoidal Wave.

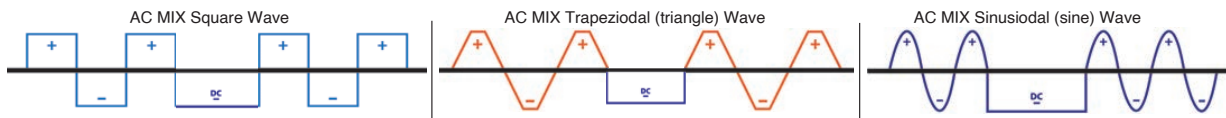

SET UP PROCEDURE FOR MIX ARC WELDING

1. Follow the step by step procedure for AC TIG Welding shown on pages 32-33



2. Select MIX ARC by pressing the TIG button until the MIX icon illuminates.

3. Select MIX HZ (Adjusts the frequency Hz (times per second) that the output current switches from AC to DC-)

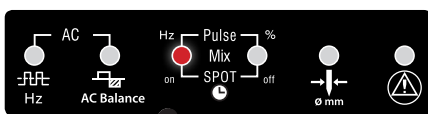

MIX Hz: Select by turning the encoder knob to cycle through to illuminate the Hz icon.



Push the Encoder to lock the icon ready for adjustment.



Turn the Encoder to set the MIX ARC Frequency Range is (1-10 Hz)



The value selected is the number of times per second that the output welding current switches from AC to DC-

4. Select MIX % Adjusts the period of DC- output during MIX ARC welding.



MIX %: Select by turning the encoder knob to cycle through to illuminate the % icon.



Push the Encoder to lock the icon ready for adjustment.



Turn the Encoder to set the MIX ARC % value Range is (5-95%)



The value selected is the % of DC- output during MIX ARC welding.

DC TIG Welding

The DC power source uses what is known as DC (direct current) in which the main electrical component known as electrons flow in only one direction from the negative pole (terminal) to the positive pole (terminal). In the DC electrical circuit, there is an electrical principle at work which should always be taken into account when using any DC circuit. With a DC circuit, 70% of the energy (heat) is always on the positive side. This needs to be understood because it determines what terminal the TIG torch will be connected to (this rule applies to all the other forms of DC welding as well).

DC TIG welding is a process in which an arc is struck between a TUNGSTEN electrode and the metal workpiece. The weld area is shielded by an inert gas flow to prevent contamination of the tungsten, molten pool and weld area. When the TIG arc is struck, the inert gas is ionized and superheated changing its molecular structure which converts it into a plasma stream. This plasma stream flowing between the tungsten and the workpiece is the TIG arc and can be as hot as 19,000°C. It is a very pure and concentrated arc which provides the controlled melting of most metals into a weld pool. TIG welding offers the user the highest amount of flexibility to weld the widest range of material and thickness and types. DC TIG welding is also the cleanest weld with no sparks or spatter.

The intensity of the arc is proportional to the current that flows from the tungsten. The welder regulates the welding current to adjust the power of the arc. Typically thin material requires a less powerful arc with less heat to melt the material, so less current (amps) is required. Thicker material requires a more powerful arc with more heat, so more current (amps) are necessary to melt the material.

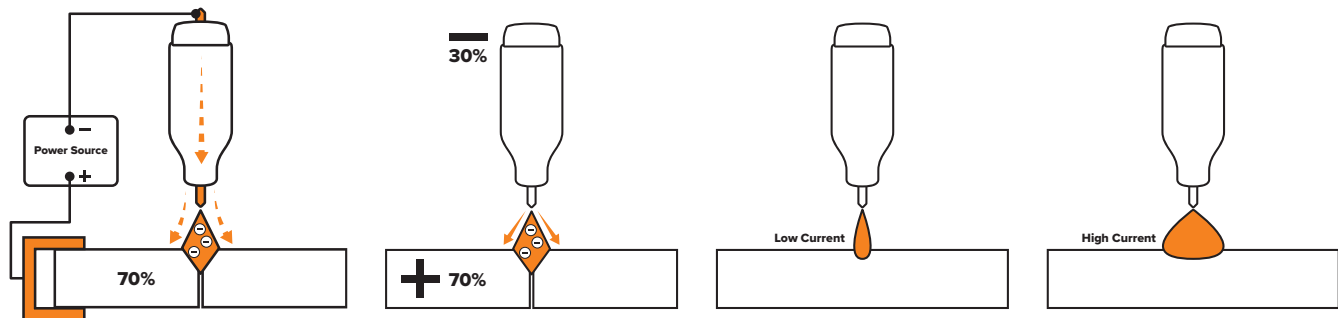

HF ARC IGNITION for TIG (tungsten inert gas) Welding

HF (high frequency) ignition allows the arc to be started in Tig welding without touching the tungsten to the work piece. By pressing the torch switch the machine will activate the gas flow and introduce the HF (high frequency) (high voltage) spark, this "ionizes" the air gap making it conductive allowing an arc to be created without touching the tungsten to the work piece. The gas molecules are superheated by the arc creating a stream of super heated gas that changes the molecular structure into producing a plasma stream. This plasma stream provides heat and energy that allows us to melt and fuse metals in an inert gas shielded environment know as TIG (tungsten inert gas) welding.

TIG WELDING GUIDE

DC TIG Welding

Pulse TIG welding is when the current output (amperage) changes between high and low current. Electronics within the welding machine create the pulse cycle. Welding is done during the high-amperage interval (this high amperage is referred to as peak current). During the low amperage period, the arc is maintained but the current output of the arc is reduced (this low amperage is referred to as base current). During pulse welding the weld pool cools during the low amperage period. This allows a lower overall heat input into the base metal. It allows for controlled heating and cooling periods during welding providing better control of heat input, weld penetration, operator control and weld appearance.

There are 4 variables within the pulse cycle:

Peak Current - Base Current - Pulse Frequency - Pulse Width

Setting and manipulation of these variables will determine the nature of the weld current output and is at the discretion of the operator.

Peak Current is the main welding current (amps) set to melt the material being welded and works much the same as setting maximum amperage values for regular DC TIG: as a guide use 30-40 amps for every 1mm of material thickness.

Base Current is the set level of background current (amps) which cools the weld puddle and effects overall heat input. As a rule, use enough background current to reduce the weld pool to about half its normal size while still keeping the weld pool fluid. As a guide start by setting the background amperage at 20 to 30 percent of peak amperage.

Pulse Frequency is the control of the amount of times per second (Hz) that the welding current switches from Peak Current to Base Current. DC Pulse TIG frequency generally ranges from 20 to 300 HZ depending on the job application. Control of the pulse frequency also determines the appearance of the weld.

Pulse Width is the control of the on time of the peak amp. It is the percentage of time the peak amp is on during one pulsing cycle. Example is with the Pulse Width set at 80 percent, the machine will spend 80% of the pulse at peak amperage and 20% at the base amperage. Increasing the pulse width percentage adds more heat to the job, while decreasing pulse width percentage reduces heat

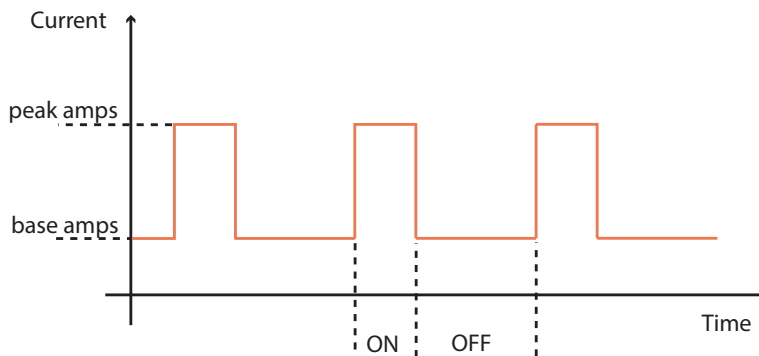

DC Pulse Tig welding allows faster welding speeds with better control of the heat input to the job, reducing the heat input minimising distortion and warping of the work and is of particular advantage in the welding of thin stainless steel and carbon steel applications. The high pulse frequency capability of the advanced inverter agitates the weld puddle and allows you to move quickly without transferring too much heat to the surrounding metal. Pulsing also constricts and focuses the arc thus increasing arc stability, penetration and travel speeds.

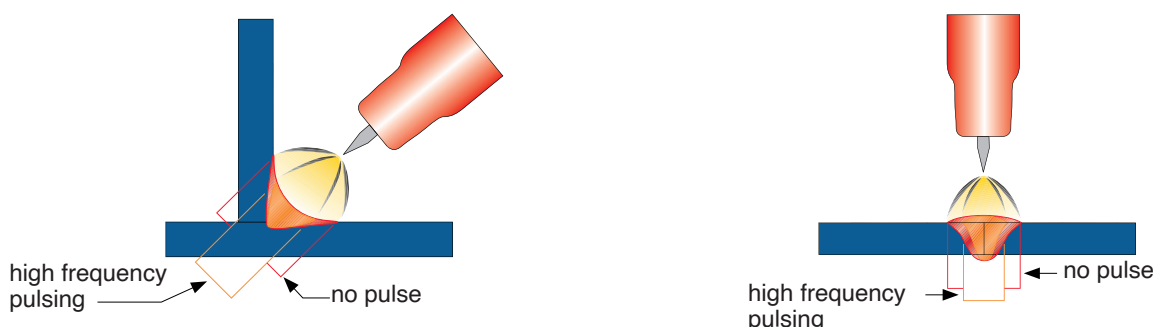

DC Pulse Welding Set Up Procedure

EXAMPLE OF PULSE DC TIG WELDING - SETUP PARAMETERS:

Material = Stainless Steel x 2.0mm / Tungsten Electrode = 1.6mm 2% Thoriated / Gas = Argon

The following steps are a guide as a starting point for you to set the machine up in Pulse mode to give an example of welding in Pulse mode function. You can experiment by changing any of the variables to see what effect it has over the welding and what the end result can be, but it is suggested to change only one variable at a time and then check the welding to see what the result is, in this way you acquire a better understanding of how each variable affects the welding current.

1. Select DC Pulse Mode



Select **DC Pulse** welding mode by pushing the **PULSE** button to select and illuminate the pulse icon.

Selecting Pulse Parameters

Select pulse parameters by turning the encoder to cycle through the front panel to select the pulse parameter icons and make settings as show in the following step by step procedure.

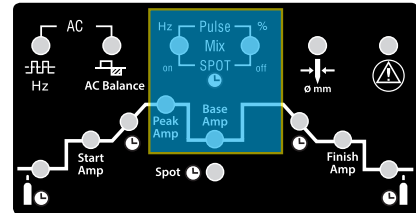

2. Select Peak Amperage

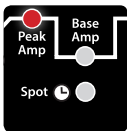

Peak Amp: Select by turning the encoder to cycle through to illuminate the **Peak Amp** icon.



Push the Encoder to lock the icon ready for adjustment.



Turn the Encoder to set Peak Amperage



The setting shows on the digital display.

3. Select Base Amperage

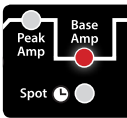

Base Amp: Turn the encoder to cycle through to illuminate the **Base Amp** icon.



Push the Encoder to lock the icon ready for adjustment.



Turn the Encoder to set Base Amperage



The setting shows on the digital display.

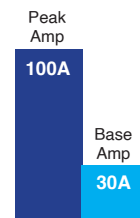

4. Select Pulse Frequency Hz

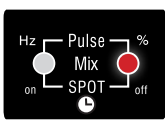

Base Amp: Turn the encoder to cycle through to illuminate the **Base Amp** icon.



Push the Encoder to lock the icon ready for adjustment.



Turn the Encoder to set the Base Amperage



The value selected is the number of times the current switches from Peak Amp to Base Amp per second

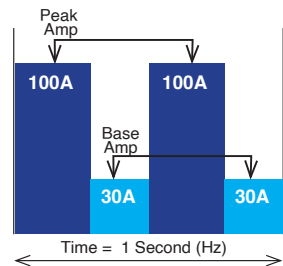

5. Select Pulse Width

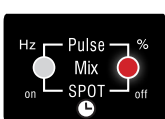

Pulse %: Turn the encoder to cycle through to illuminate the **Pulse %** icon.



Push the Encoder to lock the icon ready for adjustment.



Turn the Encoder to set the Base Amperage



The value selected is the % of time the Peak Amp is on during each pulse cycle.

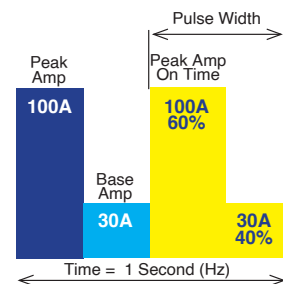

TIG Welding Fusion Technique

Manual TIG welding is often considered the most difficult of all the welding processes. Because the welder must maintain a short arc length, great care and skill are required to prevent contact between the electrode and the workpiece. Similar to Oxygen Acetylene torch welding, TIG welding typically requires two hands and in most instances requires the welder to manually feed a filler wire into the weld pool with one hand while manipulating the welding torch in the other. However, some welds combining thin materials can be accomplished without filler metal, such as edge, corner, and butt joints. This is known as Fusion welding where the edges of the metal pieces are melted together using only the heat and arc force generated by the TIG arc. Once the arc is started, the torch tungsten is held in place until a weld pool is created, a circular movement of the tungsten will assist in creating a weld pool of the desired size. Once the weld pool is established, tilt the torch at about a 75° angle and move smoothly and evenly along the joint while fusing the materials together.

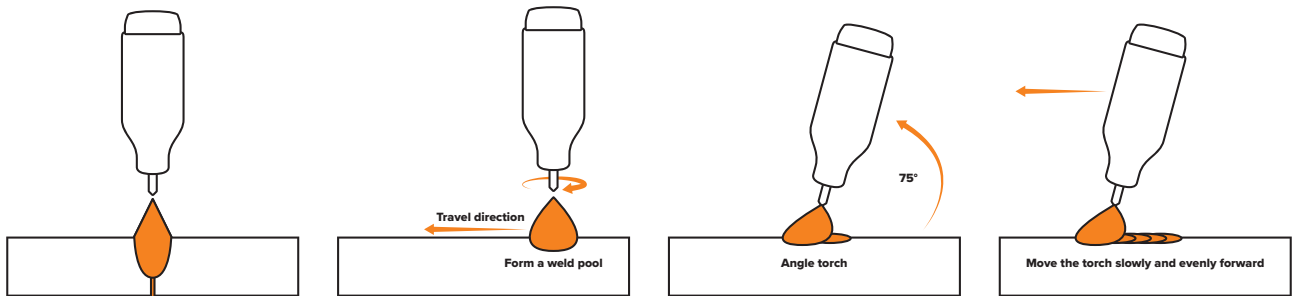

TIG Welding with Filler Wire Technique

It is necessary for many situations with TIG welding to add a filler wire into the weld pool to build up weld reinforcement and create a strong weld. Once the arc is started, the torch tungsten is held in place until a weld pool is created, a circular movement of the tungsten will assist in creating a weld pool of the desired size. Once the weld pool is established, tilt the torch at about a 75° angle and move smoothly and evenly along the joint. The filler metal is introduced to the leading edge of the weld pool. The filler wire is usually held at about a 15° angle and fed into the leading edge of the molten pool; the arc will melt the filler wire into the weld pool as the torch is moved forward. Also, a dabbing technique can be used to control the amount of filler wire added, the wire is fed into the molten pool and retracted in a repeating sequence as the torch is moved slowly and evenly forward. It is essential during the welding to keep the molten end of the filler wire inside the gas shield as this protects the end of the wire from being oxidised and contaminating the weld pool.

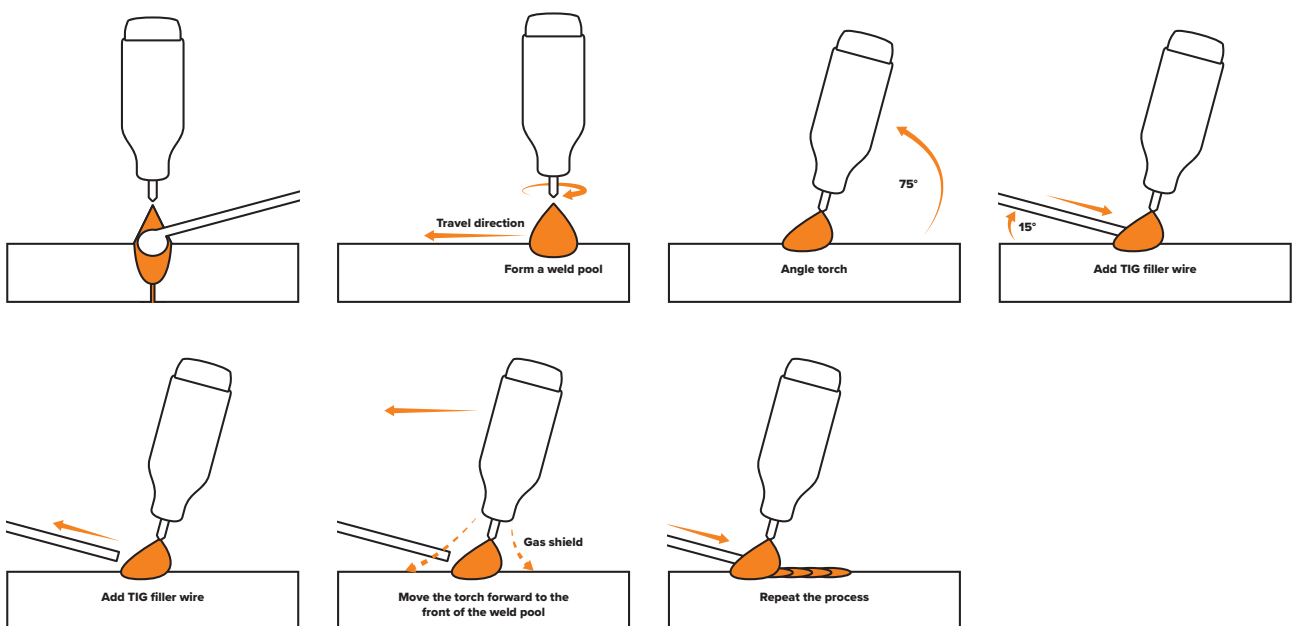

Tungsten Electrodes

- Tungsten is a rare metallic element used for manufacturing TIG welding electrodes. The TIG process relies on tungsten's hardness and high-temperature resistance to carry the welding current to the arc. Tungsten has the highest melting point of any metal, 3,410 degrees Celsius.
- Tungsten electrodes are non-consumable and come in a variety of sizes; they are made from pure tungsten or an alloy of tungsten and other rare earth elements. Choosing the correct tungsten depends on the material being welded, the number of amps required and whether you are using AC or DC welding current.
- Tungsten electrodes are colour-coded at the end for easy identification.
- Below are the most commonly used tungsten electrodes found in the New Zealand and Australian market.

Thoriated

Thoriated tungsten electrodes (AWS classification EWTh-2) contain a minimum of 97.30 per cent tungsten and 1.70 to 2.20 per cent thorium and are called 2 per cent thoriated. They are the most commonly used electrodes today and are preferred for their longevity and ease of use. Thorium, however, is a low-level radioactive hazard and many users have switched to other alternatives. Regarding the radioactivity, thorium is an alpha emitter, but when it is enclosed in a tungsten matrix, the risks are negligible. Thoriated tungsten should not get in contact with open cuts or wounds. The more significant danger to welders can occur when thorium oxide gets into the lungs. This can happen from the exposure to vapours during welding or ingestion of material/dust in the grinding of the tungsten. Follow the manufacturer's warnings, instructions, and the Material Safety Data Sheet (MSDS) for its use.

T3 (Colour Code: Purple)

T3 tungsten electrodes (AWS classification EWG) contain a minimum of 98% per cent tungsten and up to 1.5 per cent Lanthanum and small percentages of Zirconium and Yttrium they are called T3 tungsten. T3 Tungsten Electrodes provide conductivity similar to that of thoriated electrodes. Typically, this means that T3 Tungsten Electrodes are exchangeable with thoriated electrodes without requiring significant welding process changes. T3 delivers superior arc starting, electrode lifetime, and overall cost-effectiveness. When T3 Tungsten Electrodes are compared with 2% thoriated tungsten, T3 requires fewer re-grinds and provides a longer overall lifetime. Tests have shown that ignition delay with T3 Tungsten Electrodes improve over time, while 2% thoriated tungsten starts to deteriorate after only 25 starts. At equivalent energy output, T3 Tungsten Electrodes run cooler than 2% thoriated tungsten, thereby extending overall tip lifetime. T3 Tungsten Electrodes work well on AC or DC. They can be used DC electrode positive or negative with a pointed end, or balled for use with AC power sources.

Ceriated (Colour Code: Orange)

Ceriated tungsten electrodes (AWS classification EWCe-2) contain a minimum of 97.30 per cent tungsten and 1.80 to 2.20 per cent cerium and are referred to as 2 per cent ceriated. Ceriated tungstens perform best in DC welding at low current settings. They have excellent arc starts at low amperages and become popular in such applications as orbital tube welding, thin sheet metal work. They are best used to weld carbon steel, stainless steel, nickel alloys, and titanium, and in some cases, it can replace 2 per cent thoriated electrodes. Ceriated tungsten is best suited for lower amperages it should last longer than Thoriated tungsten higher amperage applications are best left to Thoriated or Lanthanated tungsten.

Lanthanated (Colour Code: Gold)

Lanthanated tungsten electrodes (AWS classification EWLan-1.5) contain a minimum of 97.80 per cent tungsten and 1.30 per cent to 1.70 per cent lanthanum and are known as 1.5 per cent lanthanated. These electrodes have excellent arc starting, a low burn-off rate, good arc stability, and excellent re-ignition characteristics. Lanthanated tungstens also share the conductivity characteristics of 2 per cent thoriated tungsten. Lanthanated tungsten electrodes are ideal if you want to optimise your welding capabilities. They work well on AC or DC electrode negative with a pointed end, or they can be balled for use with AC sine wave power sources. Lanthanated tungsten maintains a sharpened point well, which is an advantage for welding steel and stainless steel on DC or AC from square wave power sources.

Zirconiated (Colour Code: White)

Zirconiated tungsten electrodes (AWS classification EWZr-1) contain a minimum of 99.10 per cent tungsten and 0.15 to 0.40 per cent zirconium. Most commonly used for AC welding Zirconiated tungsten produces a very stable arc and is resistant to tungsten spitting. It is ideal for AC welding because it retains a balled tip and has a high resistance to contamination. Its current-carrying capacity is equal to or greater than that of thoriated tungsten. Zirconiated tungsten is not recommended for DC welding.

Tungsten Electrodes Rating for Welding Currents

Tungsten Diameter (mm)	Diameter at the Tip (mm)	Constant Included Angle (°)	Current Range (Amps)	Current Range (Pulsed Amps)
1.0mm	0.25	20	5 - 30	5 - 60
1.6mm	0.5	25	8 - 50	5 - 100
1.6mm	0.8	30	10 - 70	10 - 140
2.4mm	0.8	35	12 - 90	12 - 180
2.4mm	1.1	45	15 - 150	15 - 250
3.2mm	1.1	60	20 - 200	20 - 300
3.2mm	1.5	90	25 - 250	25 - 350

Tungsten Preparation

Always use DIAMOND wheels when grinding and cutting. While tungsten is a tough material, the surface of a diamond wheel is harder, and this makes for smooth grinding. Grinding without diamond wheels, such as aluminium oxide wheels, can lead to jagged edges, imperfections, or poor surface finishes not visible to the eye that will contribute to weld inconsistency and weld defects.

Always ensure to grind the tungsten in a longitudinal direction on the grinding wheel. Tungsten electrodes are manufactured with the molecular structure of the grain running lengthwise and thus grinding crosswise is “grinding against the grain.” If electrodes are ground crosswise, the electrons have to jump across the grinding marks, and the arc can start before the tip and wander. Grinding longitudinally with the grain causes the electrons to flow steadily and easily to the end of the tungsten tip. The arc starts straight and remains narrow, concentrated, and stable.



Electrode Tip/Flat

The shape of the tungsten electrode tip is an important process variable in precision arc welding. A good selection of tip/flat size will balance the need for several advantages. The bigger the flat, the more likely arc wander will occur and the more difficult it will be to arc start. However, increasing the flat to the maximum level that still allows arc start and eliminates arc wonder will improve the weld penetration and increase the electrode life. Some welders still grind electrodes to a sharp point, which makes arc starting easier. However, they risk decreased welding performance from melting at the tip and the possibility of the point falling off into the weld pool.



Electrode Included Angle/Taper - DC

Tungsten electrodes for DC welding should be ground longitudinally and concentrically with diamond wheels to a specific included angle in conjunction with the tip/flat preparation. Different angles produce different arc shapes and offer different weld penetration capabilities. In general, blunter electrodes that have a larger included angle provide the following benefits:

- Last Longer
- Have better weld penetration
- Have a narrower arc shape
- Can handle more amperage without eroding.

Sharper electrodes with smaller included angle provide:

- Offer less arc weld
- Have a wider arc
- Have a more consistent arc

The included angle determines the weld bead shape and size. Generally, as the included angle increases, penetration increases and bead width decreases.



SETUP FOR STICK (MMA) WELDING

- 1 For DC+ electrodes, connect earth clamp to the **negative (-)** dinse connection, and electrode holder to the **positive (+)** dinse connection.

DC+ Electrode

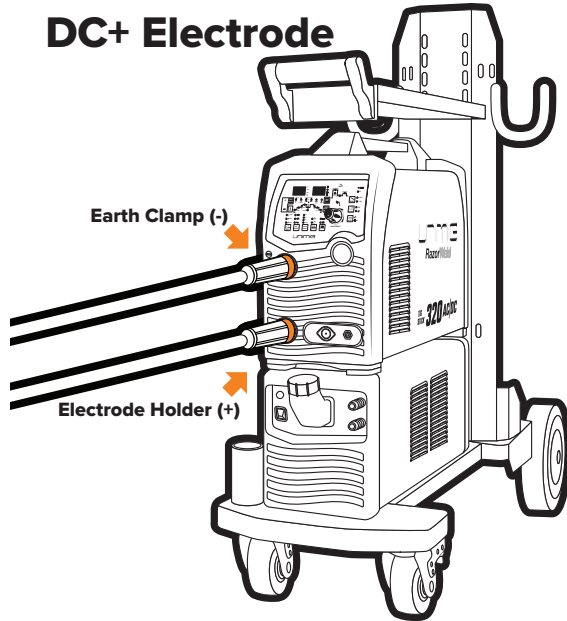

- 2 For DC- electrodes, connect earth clamp to the **positive (+)** dinse connection, and electrode holder to the **negative (-)** dinse connection.

DC- Electrode

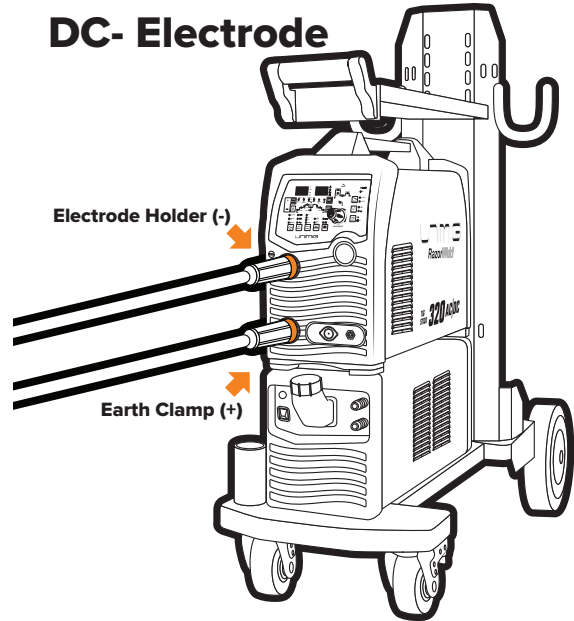

- 3 Set parameters according to MMA Control Panel Operation (Page 34).

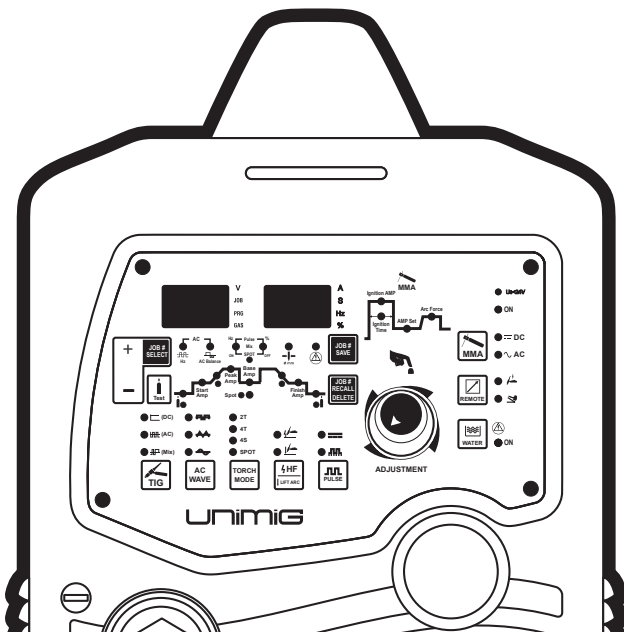

- 4 Twist electrode holder to loosen grip.

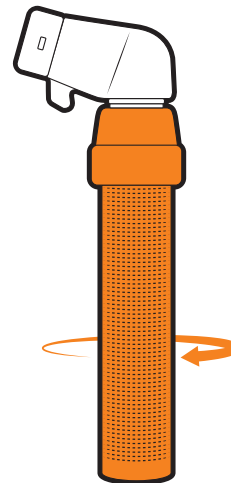

SETUP FOR STICK (MMA) WELDING

- 5 Place electrode into electrode holder.

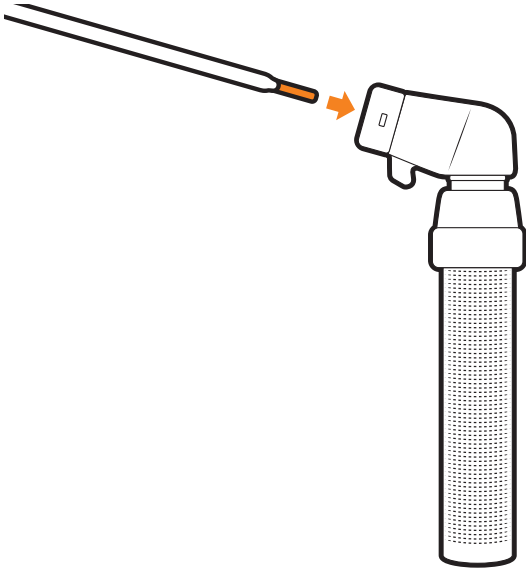

- 6 Twist electrode holder to tighten and securely grip electrode.

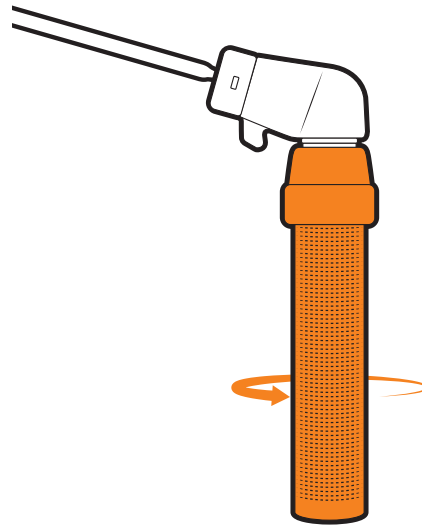

- 7 Connect earth clamp to your workpiece.

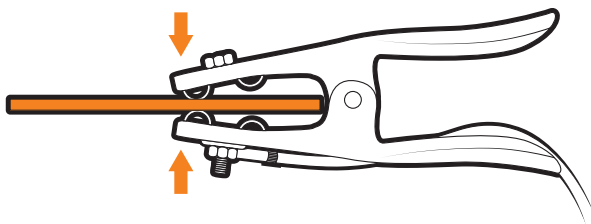

- 8 Strike electrode against workpiece to initiate arc.

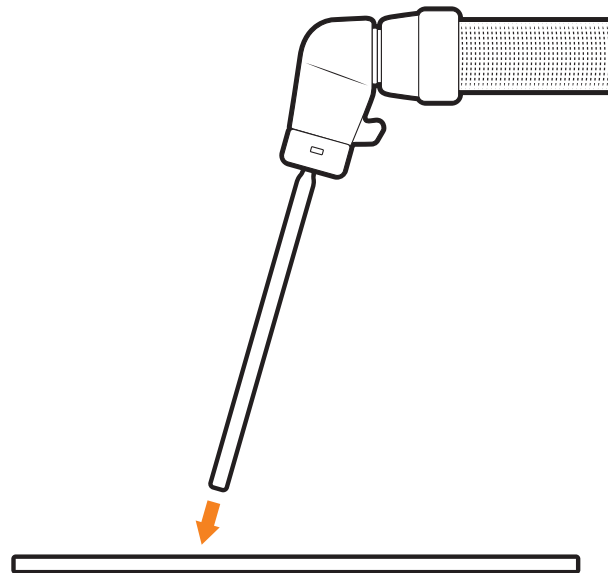

SETUP FOR STICK (MMA) WELDING

- 9 Drag along workpiece to weld. Pull the electrode away from the workpiece to finish weld.

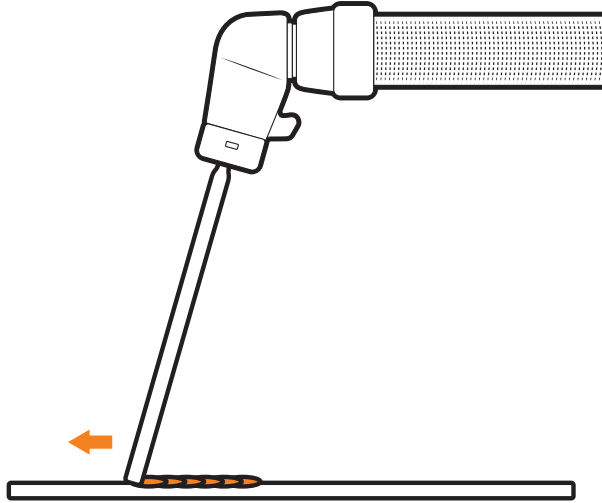

MMA CONTROL PANEL OPERATION



Adjustment Knob

Provides digital adjustment of welding parameters and provides step by step motion through the weld cycle parameters.

- **Turn the knob** to increase or decrease the desired value displayed on the LED display.
- **Press the knob** to cycle between each step of the weld cycle.



MMA Mode Selector

Enables selection of required welding mode:

- **DC**
- **AC**

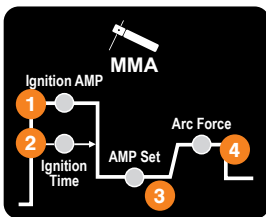

1. MMA Ignition Amp

Provides selection and adjustment of the electrode IGNITION start up properties. Sets the hot start striking arc current for the electrode start characteristic (0-270A).

2. MMA Ignition Time

Provides selection and adjustment of the electrode IGNITION Time start. Sets the time that the MMA Arc Ignition AMP time is on (0.01-1.50s).

3. MMA Amp Set

Provides selection and adjustment of welding current in MMA Mode (0-270A).

4. MMA Arc Force Control

Provides selection for adjustment of the ARC FORCE during MMA (Stick) welding. Allows setting from a soft buttery arc characteristic to a more digging, penetrating arc (0-40).

DC MMA ELECTRODE POLARITY - What is the electrode polarity and why is it important.

When using a DC power source, the question of whether to use electrode negative or positive polarity arises.

Direct current flows in one direction in an electrical circuit and the direction of current flow and the composition of the electrode coating will have a definite effect on the welding arc and weld bead. Refer to the electrode manufacturers recommendation for polarity choice.

With DC electrode (+) positive (reverse) polarity, more heat is generated at the workpiece. This produces welds with deep penetration and a narrower weld bead and can reduce the incidence of lack-of-fusion defects in the weld.

DC electrode (-) negative (straight) polarity generates more heat at the electrode and produces welds with shallower penetration. DC (-) negative electrode results in a higher burn off rate and therefore a higher deposition rate at a given current. It is generally the chosen polarity for most GP Electrodes.

AC MMA ELECTRODE Welding.

AC MMA (Stick) welding came about from old technology of AC transformer welding machines. Electrodes were manufactured to run on these AC machines. In fact, the electrodes made for AC welding will usually perform better on DC. AC is much louder and delivers a more violent arc which can cause inclusions and slag in the weld. Generally AC is more difficult to weld with than DC.

There can be a phenomenon called “arc-blow” with DC current where a magnetic field can build up and push the arc off to one side. If you are having issues with magnetism creating arc blow then the AC can help stabilise the arc and bring things back in line.

But for most other applications, AC is not needed. There are some Aluminium MMA electrodes available that do require AC current.

ARC FORCE - What is the Arc Force Control and what does it do?

During welding arc voltage drops as the arc gets tighter and can cause the electrode to stick to the work piece. Arc force should be set according to the electrode diameter, electrode type, welding current and the technical requirement.

When you set the arc force high the machine senses the drop in voltage, as the electrode is about to stick/short circuit to the work piece the machine responds by increasing the arc voltage and welding current momentarily (per millisecond). This boost in arc voltage/current blasts away base metal and electrode to prevent the electrode from sticking itself to the work piece.

High arc force means the molten droplet from the melting electrode is larger with quicker transition preventing the electrode from sticking, however too much arc force may create excessive spatter. Low arc force will result in a softer arc with minimal spatter and a nice shaped weld bead, however it may lead to the electrode sticking to the work piece easier, therefore the arc force should be adjusted to provide a smooth arc transition between the electrode and workpiece without it sticking and without providing excessive spatter.

Higher Arc Force is more suited to thicker electrodes under low amperage settings, out of position welding, low hydrogen type electrodes where a forceful arc characteristic is preferred to maintain the arc and better control penetration. Lower Arc Force is better suited to hardfacing and cast Iron electrodes where a soft buttery arc is preferred to prevent the electrode material diluting too much with the base metal.

MMA (STICK) WELDING GUIDE

STICK (MMA / Manual Metal Arc) Welding

One of the most common types of arc welding is manual metal arc welding (MMA) or MMA welding. An electric current is used to strike an arc between the base material and a consumable electrode rod or 'stick'. The electrode rod is made of a material that is compatible with the base material being welded and is covered with a flux that gives off gaseous vapours that serve as a shielding gas and providing a layer of slag, both of which protect the weld area from atmospheric contamination. The electrode core itself acts as filler material the residue from the flux that forms a slag covering over the weld metal must be chipped away after welding.

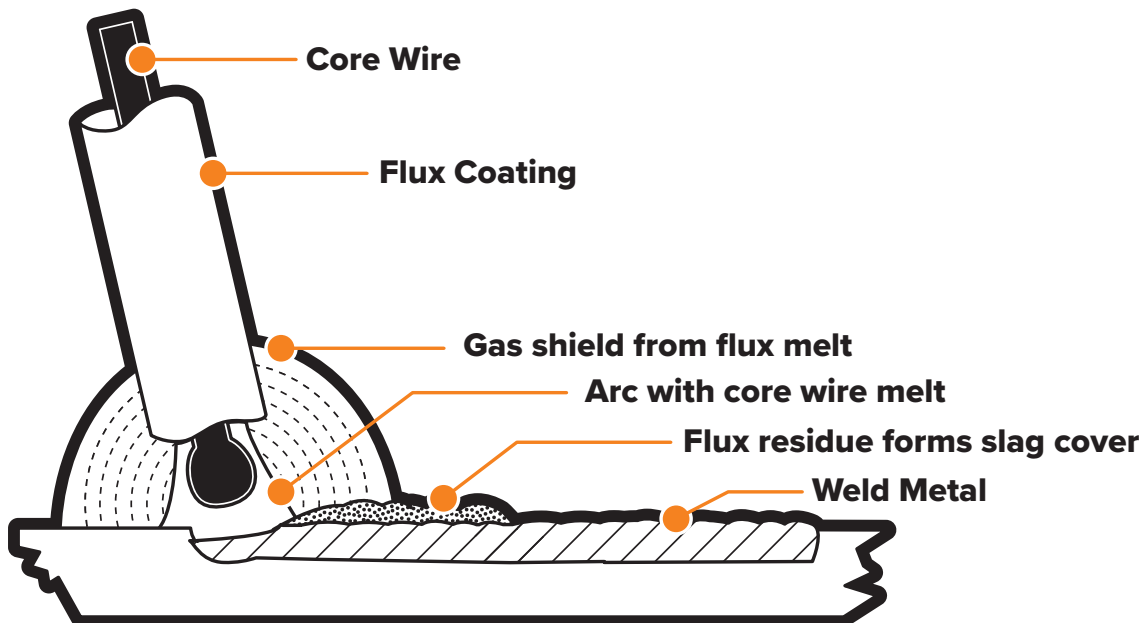

- The arc is initiated by momentarily touching the electrode to the base metal.
- The heat of the arc melts the surface of the base metal to form a molten pool at the end of the electrode.
- The melted electrode metal is transferred across the arc into the molten pool and becomes the deposited weld metal.
- The deposit is covered and protected by a slag which comes from the electrode coating.
- The arc and the immediate area are enveloped by an atmosphere of protective gas.

Manual metal arc (stick) electrodes have a solid metal wire core and a flux coating. These electrodes are identified by the wire diameter and by a series of letters and numbers. The letters and numbers identify the metal alloy and the intended use of the electrode.

The Metal Wire Core works as a conductor of the current that maintains the arc. The core wire melts and is deposited into the welding pool.

The covering on a shielded metal arc welding electrode is called Flux. The flux on the electrode performs many different functions.

These include:

- Producing a protective gas around the weld area
- Providing fluxing elements and de-oxidisers
- Creating a protective slag coating over the weld as it cools
- Establishing arc characteristics
- Adding alloying elements.

Covered electrodes serve many purposes in addition to adding filler metal to the molten pool. These additional functions are provided mainly by the covering on the electrode.

Electrode Selection

As a general rule, the selection of an electrode is straight forward, in that it is only a matter of selecting an electrode of similar composition to the parent metal. However, for some metals, there is a choice of several electrodes, each of which has particular properties to suit specific classes of work. It is recommended to consult your welding supplier for the correct selection of electrode.

The size of the electrode generally depends on the thickness of the section being welded, and the thicker the section, the larger the electrode required. The table gives the maximum size of electrodes that may be used for various thicknesses of section based on using a general-purpose type 6013 electrode.

Average Thickness of Material	Maximum Recommended Electrode Diameter
1.0 - 2.0mm	2.5mm
2.0 - 5.0mm	3.2mm
5.0 - 8.0mm	4.0mm
8.0 - > mm	5.0mm

Correct current selection for a particular job is an important factor in arc welding. With the current set too low, difficulty is experienced in striking and maintaining a stable arc. The electrode tends to MMA to work, penetration is reduced, and beads with a distinct rounded profile will be deposited. Too high current is accompanied by overheating of the electrode resulting undercut and burning through of the base metal and producing excessive spatter. Normal current for a particular job may be considered as the maximum, which can be used without burning through the work, over-heating the electrode or producing a rough spattered surface. The table shows current ranges generally recommended for a general-purpose type 6013 electrode.

Electrode Size (ø mm)	Current Range (Amps)
2.5mm	60 - 100
3.2mm	100 - 130
4.0mm	130 - 165
5.0mm	165 - 260

Arc Length

To strike the arc, the electrode should be gently scraped on the work until the arc is established. There is a simple rule for the proper arc length; it should be the shortest arc that gives a good surface to the weld. An arc too long reduces penetration, produces spatter and gives a rough surface finish to the weld. An excessively short arc will cause sticking of the electrode and result in poor quality welds. The general rule of thumb for down hand welding is to have an arc length no greater than the diameter of the core wire.

Electrode Angle

The angle that the electrode makes with the work is important to ensure a smooth, even transfer of metal. When welding in down hand, fillet, horizontal or overhead, the angle of the electrode is generally between 5 and 15 degrees towards the direction of travel. When vertical up welding, the angle of the electrode should be between 80 and 90 degrees to the workpiece.

Travel Speed

The electrode should be moved along in the direction of the joint being welded at a speed that will give the size of run required. At the same time, the electrode is fed downwards to keep the correct arc length at all times. Excessive travel speeds lead to poor fusion, lack of penetration, etc., while too slow a rate of travel will frequently lead to arc instability, slag inclusions and poor mechanical properties.

Material and Joint Preparation

The material to be welded should be clean and free of any moisture, paint, oil, grease, mill scale, rust or any other material that will hinder the arc and contaminate the weld material. Joint preparation will depend on the method used include sawing, punching, shearing, machining, flame cutting and others. In all cases, edges should be clean and free of any contaminates. The chosen application will determine the type of joint.

ARC TORCHOLOGY® T3 TIG Torch

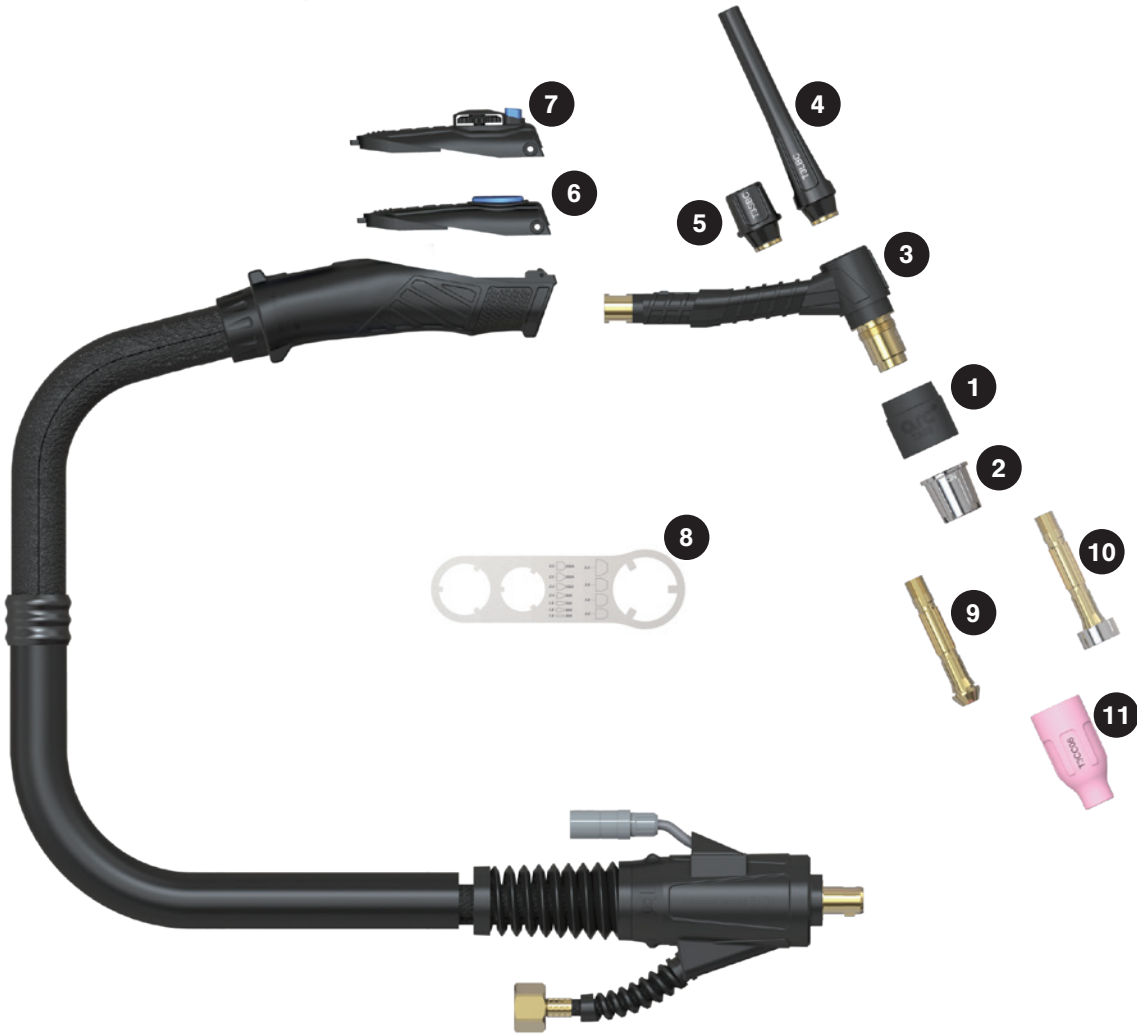

Length	4m	8m
SKU	UMT3F4M	UMT3F8M

TORCH SPARES		
1	UMCT3HG	T3 HEAD GASKET
2	UMCT3SN	T3 HEAT ISOLATOR
3	UMCT3THF	T3 TORCH HEAD FLEXIBLE HEAD
4	UMCT3LBC	T3 LONG BACK CAP
5	UMCT3SBC	T3 SHORT BACK CAP
6	UMCTMS	1 BUTTON MOMENTARY
7	UMCTMK10KP	10K POTENTIOMETER
8	UMCTSPAN	SPANNER
9	See following page	Collet Body
10	See following page	Gas Lens Collet Body

TORCH SPARES		
11	See following page	Ceramic Cup

TECHNICAL DATA	
COOLING METHOD	Air Cooled
DUTY CYCLE - DC	35% @ 190A
DUTY CYCLE - AC	35% @ 135A
LENGTHS (m)	4/8
DINSE SIZE	35/50
ELECTRODE SIZE	1.0-4.0
STANDARD	EN60974-7

T3 TIG Torch Consumables

UP TO
10X
LONGER LIFE*



Part-No	Description	Bore Size	QTY
UMCT3CB16	T3 Collet Body	1.6mm	1
UMCT3CB24	T3 Collet Body	2.4mm	1
UMCT3CB32	T3 Collet Body	3.2mm	1

UP TO
20X
LONGER LIFE*



Part-No	Description	Bore Size	QTY
UMCT3GL16	T3 Gas Lens Collet Body	1.6mm	1
UMCT3GL24	T3 Gas Lens Collet Body	2.4mm	1
UMCT3GL32	T3 Gas Lens Collet Body	3.2mm	1

UP TO
5X
LONGER LIFE*



Part-No	Description	Nozzle	Bore Size	QTY
UMCT3C04	T3 Ceramic Cup	#4	6mm	1
UMCT3C05	T3 Ceramic Cup	#5	8mm	1
UMCT3C06	T3 Ceramic Cup	#6	10mm	1
UMCT3C07	T3 Ceramic Cup	#7	11mm	1
UMCT3C08	T3 Ceramic Cup	#8	12.5mm	1
UMCT3C10	T3 Ceramic Cup	#10	16mm	1

**OVER
30%**
MORE POWER
COMPARED TO SR26

**UP TO
20X**
**LONGER LIFE FROM
CONSUMABLES**
SUPERIOR LIFE AND
BETTER PERFORMANCE



A highly effective series of passages and wells force cool the collet, maximising conductivity and extending consumable life.

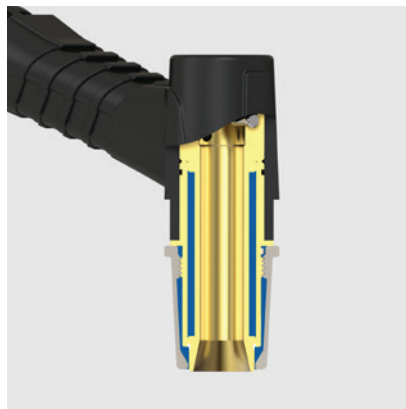

Transferred heat from the ceramic cup is isolated by a unique external barrier resulting in cooler running torches with increased power to weight performance ratios.



Trouble free extension of the electrode with a 180° twist of the back cap. There is no need to remove any other wear parts to extend the electrode.

ARC TORCHOLOGY® T3W TIG Torch

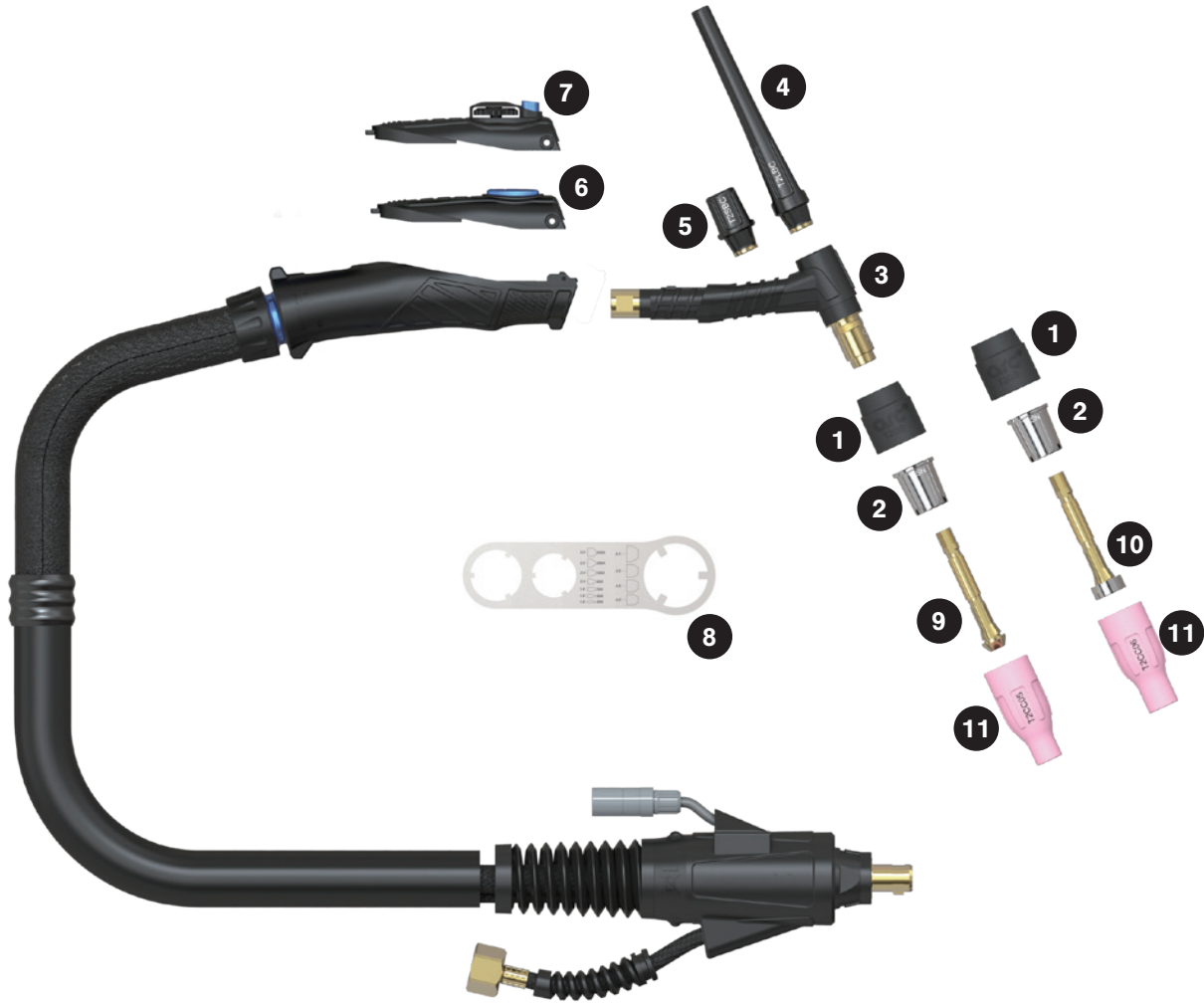

Length	4m	8m
SKU	T3W-3KHL-4M	T3W-3KHL-8M

TORCH SPARES		
1	UMCT2HG	T2/T3W HEAD GASKET
2	UMCT2SN	T2/T3W HEAT ZONE ISOLATOR
3	UMCT2THF	T2 TORCH HEAD "FLEXIBLE HEAD"
4	UMCT2LBC	T2/T3W LONG BACK CAP
5	UMCT2SBC	T2/T3W SHORT BACK CAP
6	UMCTMS	1 BUTTON MOMENTARY
7	UMCTMK10KP	10K POTENTIOMETER
8	UMCTSPAN	SPANNER
9	See following page	Collet Body
10	See following page	Gas Lens Collet Body

TORCH SPARES		
11	See following page	Ceramic Cup

TECHNICAL DATA		
COOLING METHOD	Air Cooled	
DUTY CYCLE - DC	35% @ 190A	
DUTY CYCLE - AC	35% @ 135A	
LENGTHS (m)	4/8	
DINSE SIZE	35/50	
ELECTRODE SIZE	1.0-4.0	
STANDARD	EN60974-7	

T3W TIG Torch Consumables

UP TO
10X
LONGER LIFE*



Part-No	Description	Bore Size	QTY
UMCT2CB10	T2/T3W Collet Body	1.0mm	1
UMCT2CB16	T2/T3W Collet Body	1.6mm	1
UMCT2CB24	T2/T3W Collet Body	2.4mm	1
UMCT2CB32	T2/T3W Collet Body	3.2mm	1

UP TO
20X
LONGER LIFE*



Part-No	Description	Bore Size	QTY
UMCT2GL10	T2/T3W Gas Lens Collet Body	1.0mm	1
UMCT2GL16	T2/T3W Gas Lens Collet Body	1.6mm	1
UMCT2GL24	T2/T3W Gas Lens Collet Body	2.4mm	1
UMCT2GL32	T2/T3W Gas Lens Collet Body	3.2mm	1

UP TO
5X
LONGER LIFE*



Part-No	Description	Nozzle	Bore Size	QTY
UMCT2C04	T2/T3W Ceramic Cup	#4	6mm	1
UMCT2C05	T2/T3W Ceramic Cup	#5	8mm	1
UMCT2C06	T2/T3W Ceramic Cup	#6	10mm	1
UMCT2C07	T2/T3W Ceramic Cup	#7	11mm	1
UMCT2C08	T2/T3W Ceramic Cup	#8	12.5mm	1
UMCT2C10	T2/T3W Ceramic Cup	#10	16mm	1

UP TO
20X
LONGER LIFE FROM
CONSUMABLES
SUPERIOR LIFE AND
BETTER PERFORMANCE



A highly effective series of passages and wells force cool the collet, maximising conductivity and extending consumable life.

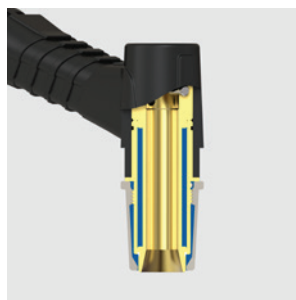

Transferred heat from the ceramic cup is isolated by a unique external barrier resulting in cooler running torches with increased power to weight performance ratios.



Trouble free extension of the electrode with a 180° twist of the back cap. There is no need to remove any other wear parts to extend the electrode.



High capacity cooling chambers remove excessive heat at source, allowing greater performance from a smaller body.

MACHINE PARTS BREAKDOWN

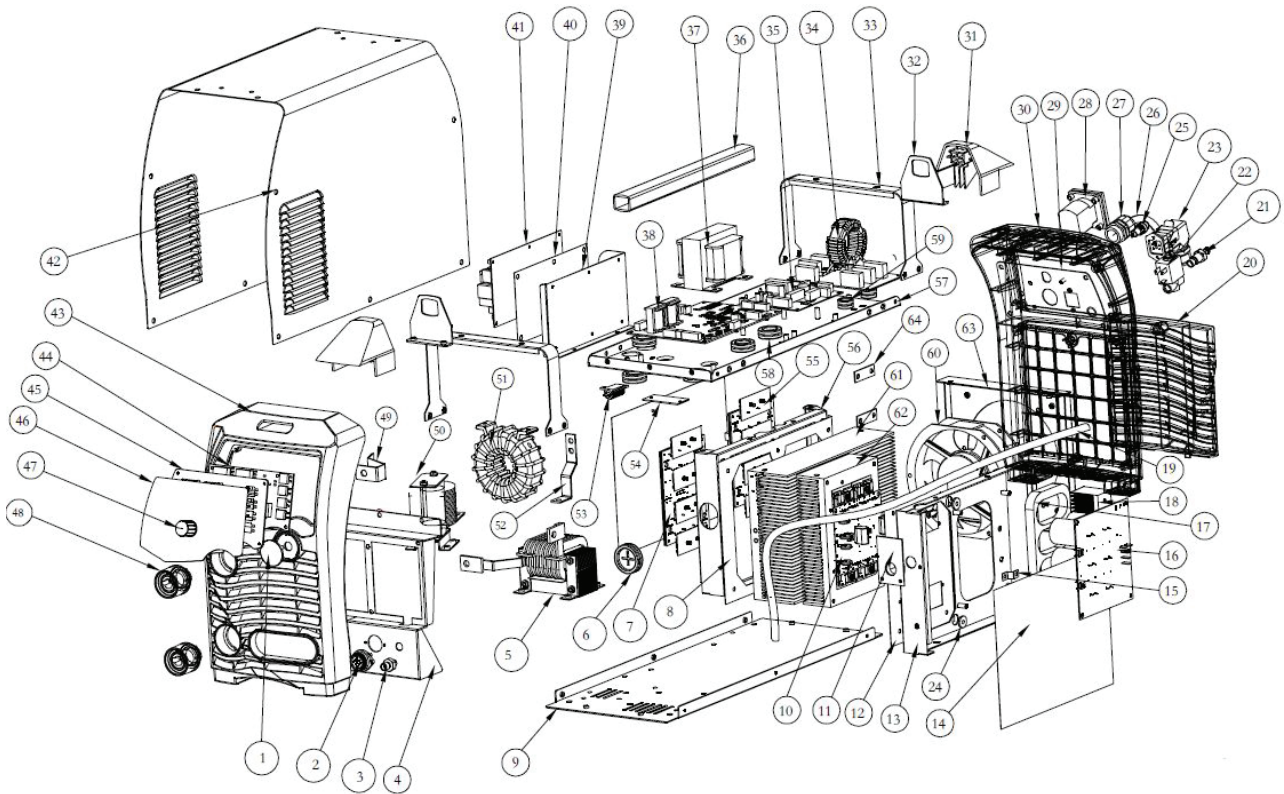

MACHINE SPARES

1	10041712	Trademark cover
2	10066345	Aviation outlet
3	10042337	Gas fitting (front panel)
4	10066398	Front support
5	10066723	Reactor
6	10050722	Ø30 coil
7	10066582	Secondary inverter board
8	10066439	Secondary inverter side insulation paper
9	10066393	Machine bottom
10	10066501	Primary inverter board
11	10000815	Current sampling board
12	10066440	Primary inverter side insulation paper
13	10066442	Primary inverter side bracket
14	10066441	Insulation baffle
15	10064404	Primary inverter side connector
16	10066430	Filter plate
17	10066603	PCB cotton pad
18	10066510	Silicon bridge radiator
19	10066347	Gas pipe
20	10058230	Shutters
21	10064977	Gas fitting
22	10066347	Electromagnetic valve
23	10037422	Rectangular aviation outlet
24	10064426	Insulation mat
25	10045291	Fuse holder
26	10050672	Power cable
27	10021913	Line buckle
28	10064104	Rotary switch
29	10065285	Rear fixing plate
30	10060838	Plastic rear panel
31	10060835	Plastic handle seat
32	10058239	Handle seat bracket

MACHINE SPARES

33	10066434	Cover bracket
34	10027249	EMC board
35	10066937	Switch power board
36	10058227	Handle bar
37	10064706	Power frequency transformer
38	10066731	Main control board
39	10064369	PCB bracket
40	10066446	PCB insulation board
41	10066623	Arc strike stabilization plate
42	10066444	Cover
43	10065002	Front panel
44	10066433	Display panel
45	10066375	Control panel indicator module
46	10066426	Front panel sticker
47	10040930	Knob
48	10045432	Quick outlet
49	10066438	Output connector
50	10066722	Arc starter
51	10068137	Main transformer
52	10066436	Arc starter connector
53	10064729	Resistor
54	10066647	Port board
55	10064093	Ceramic wafer
56	10066443	Secondary side bracket
57	10066445	Middle partition
58	10046803	Ø20 protective coil
59	10046802	Ø14 protective coil
60	10067624	Fan
61	10066511	Secondary side radiator
62	10066512	Primary side radiator
63	10065284	Rear support plate
64	10066395	Secondary side connector

TIG TROUBLESHOOTING

1. Tungsten burning away quickly

- **Incorrect Gas or No Gas.** Use pure Argon. Check cylinder has gas, connected, turned on and torch valve is open.
- **Inadequate gas flow.** Check the gas is connected, check hoses, gas valve and torch are not restricted.
- **Back cap not fitted correctly.** Make sure the torch back cap is fitted so that the O-ring is inside the torch body.
- **Torch connected to DC+.** Connect the torch to the DC- output terminal.
- **Incorrect tungsten being used.** Check and change the tungsten type if necessary.
- **Tungsten being oxidised after weld is finished.** Keep shielding gas flowing 10–15 seconds after arc stoppage. 1 second for each 10 amps of weld current.

2. Contaminated tungsten

- **Touching tungsten into the weld pool.** Keep tungsten from contacting weld puddle. Raise the torch so that the tungsten is off of the work piece 2 - 5mm.
- **Touching the filler wire to the tungsten.** Keep the filler wire from touching the tungsten during welding, feed the filler wire into the leading edge of the weld pool in front of the tungsten.

3. Porosity - poor weld appearance and colour

- **Wrong gas / poor gas flow / gas leaks.** Use pure argon. Gas is connected, check hoses, gas valve and torch are not restricted. Set the gas flow between 6-12 l/min. Check hoses and fittings for holes, leaks etc.
- **Contaminated base metal.** Remove moisture and materials like paint, grease, oil, and dirt from base metal.
- **Contaminated filler wire.** Remove all grease, oil, or moisture from filler metal.
- **Incorrect filler wire.** Check the filler wire and change if necessary.

4. Yellowish residue / smoke on the alumina nozzle & discoloured tungsten

- **Incorrect Gas.** Use pure Argon gas.
- **Inadequate gas flow.** Set the gas flow between 10 - 15 L/min flow rate.
- **Alumina gas nozzle too small.** Increase the size of the alumina gas nozzle.

5. Unstable Arc during DC welding

- **Torch connected to DC+.** Connect the torch to the DC- output terminal.
- **Contaminated base metal.** Remove materials like paint, grease, oil, and dirt, including mill scale from base metal.
- **Tungsten is contaminated.** Remove 10mm of contaminated tungsten and re grind the tungsten.
- **Arc length too long.** Lower torch so that the tungsten is off of the work piece 2 - 5mm.

6. Arc wanders during DC welding

- **Poor gas flow.** Check and set the gas flow between 10 - 15 L/min flow rate.
- **Incorrect arc length.** Lower torch so that the tungsten is off of the work piece 2 - 5mm.
- **Tungsten incorrect or in poor condition.** Check that correct type of tungsten is being used. Remove 10mm from the weld end of the tungsten and re sharpen the tungsten.
- **Poorly prepared tungsten.** Grind marks should run lengthwise with tungsten, not circular. Use proper grinding method and wheel.
- **Contaminated base metal or filler wire.** Remove contaminating materials like paint, grease, oil, and dirt, including mill scale from base metal. Remove all grease, oil, or moisture from filler metal.

7. Arc difficult to start or will not start DC welding

- **Incorrect machine set up.** Check machine set up is correct.
- **No gas, incorrect gas flow.** Check the gas is connected and cylinder valve open, check hoses, gas valve and torch are not restricted. Set the gas flow between 10 - 15 L/min flow rate.
- **Incorrect tungsten size or type.** Check and change the size and or the tungsten if required.
- **Loose connection.** Check all connectors and tighten.
- **Earth clamp not connected to work.** Connect the earth clamp directly to the work piece wherever possible.

STICK (MMA) TROUBLESHOOTING

1. No arc.

- **Incomplete welding circuit.** Check earth lead is connected. Check all cable connections. .
- **Wrong mode selected.** Check the MMA selector switch is selected.
- **No power supply.** Check that the machine is switched on and has a power supply.

2. Porosity: Small cavities or holes resulting from gas pockets in weld metal.

- **Arc length too long.** Shorten the arc length.
- **Work piece dirty, contaminated or moisture.** Remove moisture and materials like paint, grease, oil, and dirt, including mill scale from base metal.
- **Damp electrodes.** Use only dry electrodes.

3. Excessive Spatter.

- **Amperage too high.** Decrease the amperage or choose a larger electrode.
- **Arc length too long.** Shorten the arc length.

4. Weld sits on top, lack of fusion.

- **Insufficient heat input.** Increase the amperage or choose a larger electrode.
- **Work piece dirty, contaminated or moisture.** Remove moisture and materials like paint, grease, oil, and dirt, including mill scale from base metal.
- **Poor welding technique.** Use the correct welding technique or seek assistance for the correct technique.

5. Lack of penetration.

- **Insufficient heat input.** Increase the amperage or choose a larger electrode.
- **Poor welding technique.** Use the correct welding technique or seek assistance for the correct technique.
- **Poor joint preparation.** Check the joint design and fit up, make sure the material is not too thick. Seek assistance for the correct joint design and fit up.

6. Excessive penetration: Burn through.

- **Excessive heat input.** Reduce the amperage or use a smaller electrode.
- **Incorrect travel speed.** Try increasing the weld travel speed.

7. Uneven weld appearance.

- **Unsteady hand, wavering hand.** Use two hands where possible to steady up, practise your technique.

8. Distortion: Movement of base metal during welding.

- **Excessive heat input.** Reduce the amperage or use a smaller electrode.
- **Poor welding technique.** Use the correct welding technique or seek assistance for the correct technique.
- **Poor joint preparation and or joint design.** Check the joint design and fit up, make sure the material is not too thick. Seek assistance for the correct joint design and fit up.

9. Electrode welds with different or unusual arc characteristic.

- **Incorrect polarity.** Change the polarity, check the electrode manufacturer for correct polarity.



HEAD OFFICE:

112 Christina Rd,
Villawood NSW 2163

PH: (02) 9780 4200
FAX: (02) 9780 4210

EMAIL: sales@unimig.com.au

QLD OFFICE:

180 Kerry Rd,
Archerfield QLD 4108

PH: (07) 3333 2855
FAX: (07) 3274 5829

EMAIL: qld@unimig.com.au

VIC OFFICE:

91 Yellowbox Drive,
Craigieburn VIC 3064

PH: (03) 8682 9911
FAX: (03) 9333 7867

EMAIL: vicsales@unimig.com.au

WA OFFICE:

Unit 2/29 Biscayne Way,
Jandakot WA 6164

PH: (08) 6363 5111
FAX: (08) 9417 4781

EMAIL: wasales@unimig.com.au