

BTR

www.betterlightings.com



工厂

Factory:

Ningbo Beter Lighting Co., Ltd
Laofangqiao Industry Zone, Yuyao, Zhejiang Province, China
浙江省余姚市老方桥工业园区

Export (出口):

E-mail: sale-4@betterlightings.com
peterlu@betterlightings.com
Tel: +86-574-6247 8212
+86-574-6247 8363
+86-574-6247 7777
Fax: +86-574-6247 8377

Domestic (国内):

E-mail: sale100@betterlightings.com
Tel: +86-574-6247 8358
Fax: +86-574-6247 8377

<http://www.betterlightings.com>

Light up your life

BTR
贝泰照明

BETER LIGHTING

Project Catalog 景观照明工程目录

2017

贝泰照明成立于2001年，是一家全球化的国家级高新技术照明公司。销售和研发总部设在德国，在澳大利亚和美国拥有自己的研发和销售公司。

公司在宁波现有两个事业部，包括户外照明工程事业部、庭院灯事业部，共占地面积达40000平方米，拥有800名高素质的优秀员工团队(其中超过40人的研发团队)。

主要产品包括户外景观灯、道路灯、庭院灯及室内商业照明和LED光源产品。

公司拥有超过250项国际专利，并建立了国际第三方法国Bureau Veritas (法国质量监督局下属公司) 专业合作照明实验室。

公司通过了ISO9001质量体系，2008年通过欧盟采购集团联盟认证体系BSCI及美国SA8000，公司产品通过EMC, LVD, CE, GS, ROHS, REACH, UL和CCC等认证。

公司拥有一级和三级施工资质。

贝泰照明BTR品牌已在全球40多个国家和地区推广使用，并深得消费者喜欢。

BTR品牌承载的“让我们做的更好”的经营理念是我们始终不渝的追求。

BTR贝泰照明，一家世界级的新星照明企业已经冉冉升起！

BTR (Beter Lighting) was founded in 2001, which is a global Nation-High-Tech lighting company. Its sales and R&D headquarter is located in Germany. In USA and Australia, both own sales and R&D offices.

The company has 2 business departments in Ningbo manufacture center, including outdoor project department, garden light department. The company owns 40000 square meter building and over 800 skilled employees (more than 40 engineers team).

The company's main products are including outdoor project lights, streetlights, garden lights, indoor commercial lights and LED light sources.

The company owns more than 250 global patents and the third party.

Bureau Veritas international cooperation lighting laboratory.

The company has first and three construction qualification.

BTR has passed ISO9001, BSCI, SA8000 and also owns certification of EMC, LVD, CE, GS, ROHS, REACH, UL and CCC etc.

BTR has promoted its brand and products over 40 countries and areas, winning are their appreciation.

BTR carries: LET'S DO BETTER is our forever goal.

BTR: a new global lighting company is raising now!

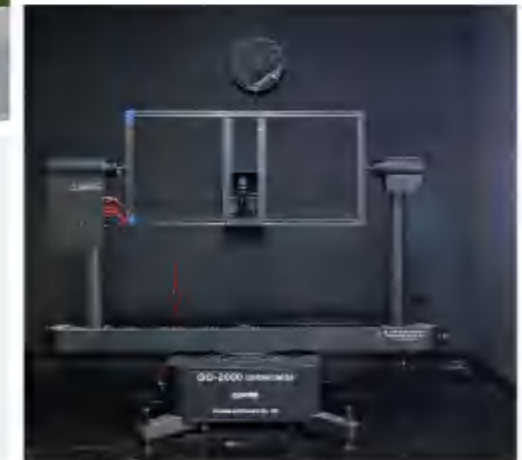

研发 / R&D

研发 / R&D

贝泰拥有光学设计、电器设计、结构设计、工业设计各方面的研发人员，形成贝泰完整独有的设计研发体系，能够根据户外照明的应用需求，独立设计、开发LED和HID路灯、庭院灯、地埋灯、投光灯、隧道灯、草坪灯、壁灯、嵌墙灯、水下射灯、线条灯、景观装饰灯等系列产品，并具备户外照明方案的设计能力。

Beter Lighting has experienced engineers in optics designing, electricity designing, construction designing, which to be a complete and unique R&D system. We can design and develop different kinds of lightings according to customers' need, including LED light, HID light, garden light, inground light, flood light, tunnel light, lawn light, recessed wall light, underwater and spot light, line light and landscape light etc.



自动喷涂线
Automatic powder coating line



高效的生产流水线
High-efficiency production assembling line



大型折弯机
Large bending machine

生产 / Production

生产 / Production



老化线
Aging line



贴片焊接线
Patch welding wire

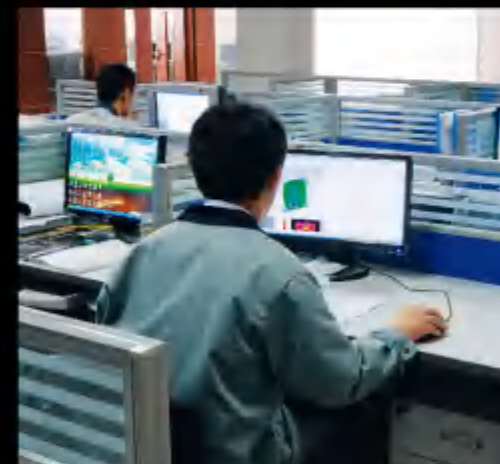

光学设计
Optics designing

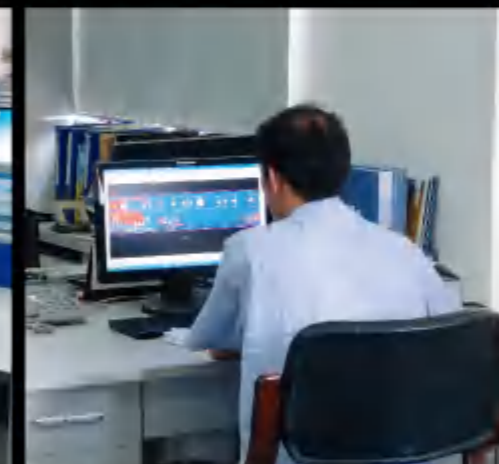

电器设计
Electricity designing



产品结构
Product construction designing

相关认证 / Certification

专利证书 / Patent Certificate



LED路灯节能效果的分析

Analysis of Energy Saving on LED Street Light

对比项目 Comparison project	250W HID 高压钠灯 High pressure sodium lamp	120W LED 节能路灯 Energy-saving Street Light																		
<p>■ 光源节能比较 Comparison of electricity saving</p> <p>以1公里计算, 安装60盏路灯, LED与高压钠灯的电费节能比较。 For example in 1 kilometer, installation of 60 pieces street lamps, LED Street Lighting and high-pressure sodium lamp of electricity compared.</p> <table border="1"> <tr><td>光源功率 Light power</td><td>250W</td><td>120W</td></tr> <tr><td>线路电气耗电 Electric power lines</td><td>35W</td><td>0W</td></tr> <tr><td>实际功耗 Total power consumption</td><td>285W</td><td>120 W</td></tr> <tr><td>每天用电量(千瓦时) Using actual electricity per/day</td><td>$285W \times 60 \times 10H = 171$</td><td>$120W \times 60 \times 10H = 72$</td></tr> <tr><td>每公里60盏年电费 Annual tariff of 60 pieces lightings per/km</td><td>62415 RMB (1元/度)</td><td>26280 RMB</td></tr> <tr><td>每年节约经济效益 Annual saving rate</td><td></td><td>36135 RMB</td></tr> </table> <p>八年寿命周期节约经济效益 Saving rate in 8 years life span</p>	光源功率 Light power	250W	120W	线路电气耗电 Electric power lines	35W	0W	实际功耗 Total power consumption	285W	120 W	每天用电量(千瓦时) Using actual electricity per/day	$285W \times 60 \times 10H = 171$	$120W \times 60 \times 10H = 72$	每公里60盏年电费 Annual tariff of 60 pieces lightings per/km	62415 RMB (1元/度)	26280 RMB	每年节约经济效益 Annual saving rate		36135 RMB	<p>Vs</p>	<p>289080 RMB</p>
光源功率 Light power	250W	120W																		
线路电气耗电 Electric power lines	35W	0W																		
实际功耗 Total power consumption	285W	120 W																		
每天用电量(千瓦时) Using actual electricity per/day	$285W \times 60 \times 10H = 171$	$120W \times 60 \times 10H = 72$																		
每公里60盏年电费 Annual tariff of 60 pieces lightings per/km	62415 RMB (1元/度)	26280 RMB																		
每年节约经济效益 Annual saving rate		36135 RMB																		
<p>■ 灯具采购费用的比较 Comparison of lighting purchasing costs</p> <p>以1公里计算, 安装60盏路灯比较。 For example in 1 kilometer, installation of 60 pieces street lamps comparison.</p> <table border="1"> <tr><td>路灯数量 Street lighting quantity</td><td>60盏</td><td>60盏</td></tr> <tr><td>单盏价格 Unit price</td><td>800 RMB</td><td>1100 RMB</td></tr> <tr><td>采购费用 Purchasing cost</td><td>48000 RMB</td><td>66000 RMB</td></tr> </table> <p>节约经济效益 Saving rate</p>	路灯数量 Street lighting quantity	60盏	60盏	单盏价格 Unit price	800 RMB	1100 RMB	采购费用 Purchasing cost	48000 RMB	66000 RMB	<p>Vs</p>	<p>-18000 RMB</p>									
路灯数量 Street lighting quantity	60盏	60盏																		
单盏价格 Unit price	800 RMB	1100 RMB																		
采购费用 Purchasing cost	48000 RMB	66000 RMB																		
<p>■ 使用寿命及维护费用比较 Comparison of using life and maintenance costs</p> <p>寿命与维护分析: Analysis of Life and maintenance: 国产的高压钠灯寿命只能达到4000-5000小时, 而单颗LED的寿命在40000小时以上, 集体变成一个特大功率的LED后寿命在30000小时以上, 寿命是最好的高压钠灯5倍以上。在寿命周期内以8年计算, LED路灯安装后不需更换, 高压钠灯需更换5次以上。 The Chinese domestic made HID can only reach to 4000 to 5000 hours in life, the single LED can reach to 40000 hours in life, moreover, one power LED can reach 30000 hours in life, it is more than 5 times than normal HID lamp. Supposed to use 8 years as the life span, LED street light doesn't need to be replaced after installation, but the HID lamp need to be replaced over 5 times.</p> <table border="1"> <tr><td>光源寿命 Life of lighting source</td><td>5000H</td><td>30000H</td></tr> <tr><td>8年内维护次数 Times of maintance 8years</td><td>5次</td><td>1次</td></tr> <tr><td>更换光源费用 lighting costs of replacement</td><td>$250/每次 \times 5 = 1250$ RMB</td><td>$250/每次 \times 1 = 250$ RMB</td></tr> <tr><td>人工等维护费用 Maintenance cost of labor</td><td>$100/每次 \times 5 = 500$ RMB</td><td>$100/每次 \times 1 = 100$ RMB</td></tr> <tr><td>合计费用 Total fees</td><td>1750 RMB</td><td>350 RMB</td></tr> <tr><td>1公里60盏 60pcs/km</td><td>RMB: $1750 \times 60 = 105000$ RMB</td><td>RMB: $350 \times 60 = 21000$ RMB</td></tr> </table> <p>节约经济效益 Saving rate</p>	光源寿命 Life of lighting source	5000H	30000H	8年内维护次数 Times of maintance 8years	5次	1次	更换光源费用 lighting costs of replacement	$250/每次 \times 5 = 1250$ RMB	$250/每次 \times 1 = 250$ RMB	人工等维护费用 Maintenance cost of labor	$100/每次 \times 5 = 500$ RMB	$100/每次 \times 1 = 100$ RMB	合计费用 Total fees	1750 RMB	350 RMB	1公里60盏 60pcs/km	RMB: $1750 \times 60 = 105000$ RMB	RMB: $350 \times 60 = 21000$ RMB	<p>Vs</p>	<p>84000 RMB</p>
光源寿命 Life of lighting source	5000H	30000H																		
8年内维护次数 Times of maintance 8years	5次	1次																		
更换光源费用 lighting costs of replacement	$250/每次 \times 5 = 1250$ RMB	$250/每次 \times 1 = 250$ RMB																		
人工等维护费用 Maintenance cost of labor	$100/每次 \times 5 = 500$ RMB	$100/每次 \times 1 = 100$ RMB																		
合计费用 Total fees	1750 RMB	350 RMB																		
1公里60盏 60pcs/km	RMB: $1750 \times 60 = 105000$ RMB	RMB: $350 \times 60 = 21000$ RMB																		



改LED路灯费用分析
Cost analysis of LED street lamp

综合结论: General Conclusion:

以上是贝泰120W LED路灯与250W高压钠灯的对比(120W的LED路灯光效等于250W的高压钠灯的光效)。LED路灯的优势明显!

未计算节约的铺设成本, LED路灯替代传统路灯在光源成本方面不占优势, 多投入1.8万元, 但在寿命周期内, 以8年计算, 维护费用每公里约节省84000元, 更换后节省的电费289080元, 8年共可节约373080元。

The above is the comparison of better lighting about the 120W LED street light and 250W HID lamp (the illumination efficiency of 120W LED street light equals to 250W HID lamp), the advantage of the LED street light is entire!

Without calculating the insilation cost, LED street light has no advantage on lighting souce cost compared to traditional street light, it must cost RMB 18,000 more.

Supposed to use a 8 years life circle, the maintance cost can be saved RMB 84000 per kilometer, after replacement, the saving electricity cost is RMB 289080, so total can save RMB 373080 in total 8 years.

耗电每公里8年可节约: Power consumption savings per kilometer in 8 years:

289080 RMB

社会责任，资源节约

Social Responsibility, Resource Saving

采用LED照明，除了带来的可观经济利益外，带来巨大的社会效益。一万盏250W高压钠灯采用LED更换后，每年至少节约电555万度。

大量减少了硫化物和碳化物的排放和煤炭使用量，符合现在全球低碳经济，有益于子孙万代。以下是各种原材料节约量以及废物的年减排情况：

煤炭全年节约量=3615吨，净水全年节约量=3615万升，碳粉尘减排量=2458吨，二氧化碳减排量=9001吨，SO₂减排量=271吨。

Useing of LED lighting, in addition to bring considerable economic benefits, great benefits. 10,000 250 degree high pressure sodium lamps with LED replacement, save power 5.55 million degrees.

Significant reduction in the sulfur and carbon emissions and coal use. Meet the current global low carbon economy. Benefit of future generations. The following is quantity of various raw material savings and waste reduction on the situation.

Amount of annual savings of coal = 3615 tons, annual savings amount of water = 36.15 million liters, toner dust emissions reductions = 2,458 tons of carbon dioxide emissions reductions = 9,001 tons, SO₂ = 271 tons of emission reductions.



BTR
贝泰照明

贝泰之星 BTR STAR

即使所有产品终将会被人遗忘
然而
总有一些经典将会写入我们的史册
总有一些情怀值得我们永久的寄托
这一刻
我只想给予它更多呼吸的空隙
让人对它记住的更久一些

贝泰之星——闪耀着我们的光芒！

Even if all the products will eventually be forgotten
However
There will always be some classics in our history
There are always some feelings worthy of our permanent sustenance
This moment
I just want to give it more breathing space
Let it be remembered for longer

BTR STAR - Shining our light!

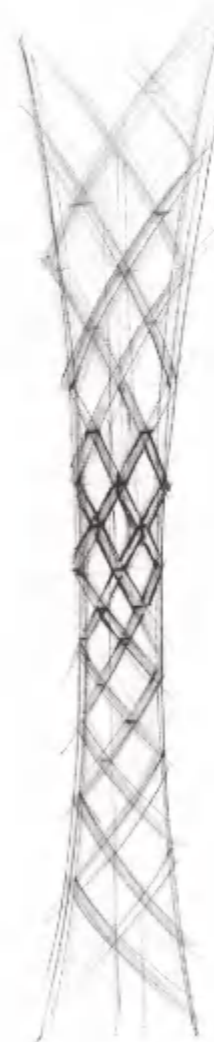
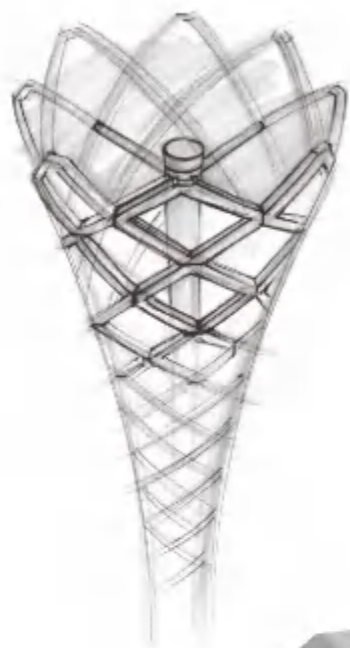

BTR
贝泰照明

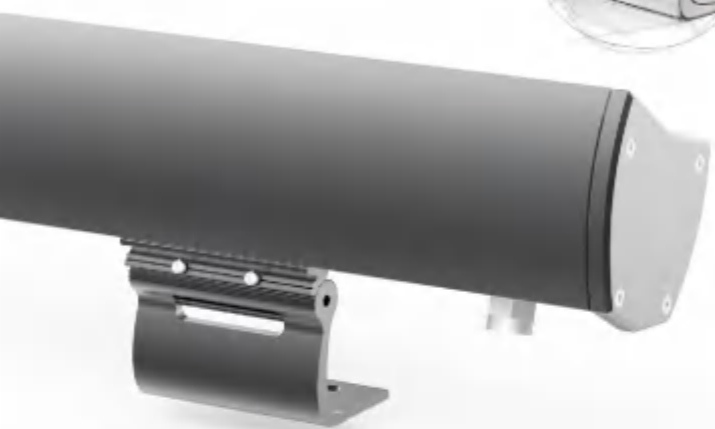
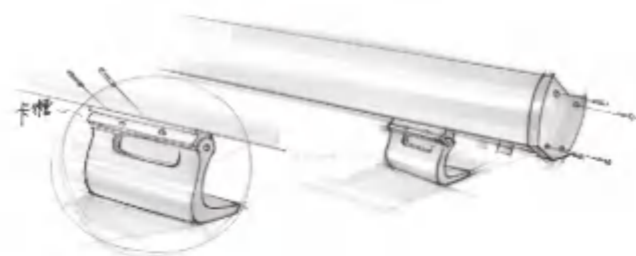

水纹盾 RIPPLES SHIELD

没有蓝天的辽阔
没有大海的波澜

我们只想将那淡蓝的水纹
停格在某一处不经意的角落
为这宁静的夜晚
增添一份无声的惬意!

There is no blue sky the extensive
No sea waves

We just want to be the blue water
Stop at the corner of a place
For this peaceful night
Add a silent cozy!





引路星

GUIDING STAR

总有一条路
指引着回家的方向
总有一盏灯
闪烁着成功的光芒

抑或
与这沿途的时光
一路纷扬!

There is always a way
Guiding the way home
There is always a lamp
Shining with the light of success

Or
With the time along the way
All the way!

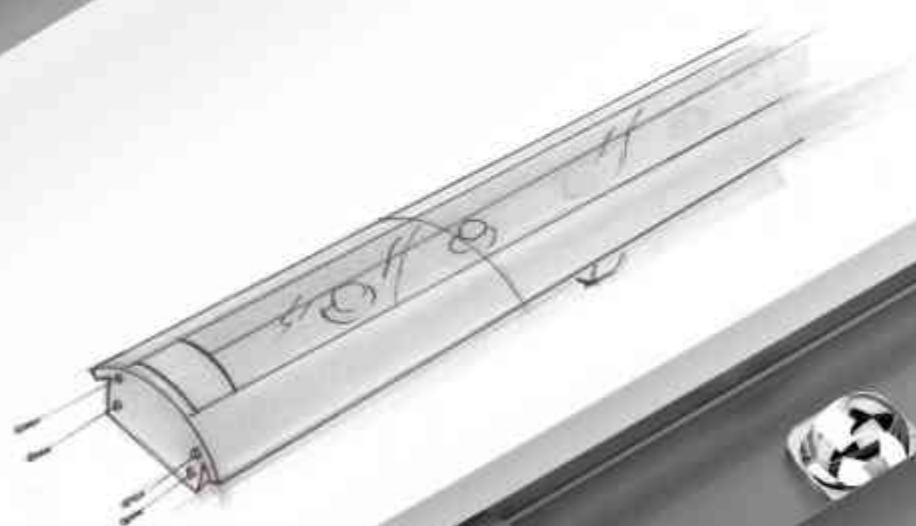

BTR
贝泰照明



守护者 GUARDIAN

没有华丽的装饰
没有艳丽的外表
我只想为这城市的某一建筑
工作的更久一些
用我的光芒
来书写另一个金碧辉煌的奇迹!

No ornate decoration
No bright coat

I just want a certain building in the city
Work longer

With my light
To write a beautiful decoration miracle!

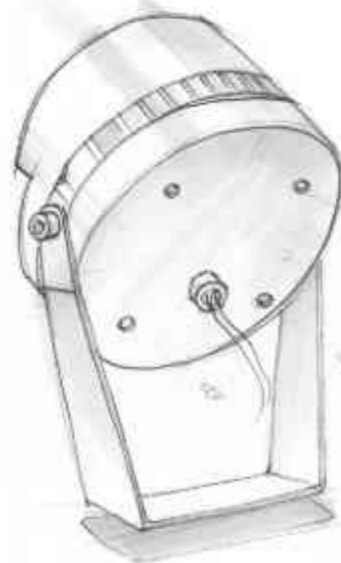

BT9227-LED36

专利号 Num: 201630151769.3



丝印超白钢化玻璃, 提升美观程度。
Silk-printing ultrawhite tempered glass.



防水公母插连接, 便于安装。
Waterproof female plug connection, easy to install.

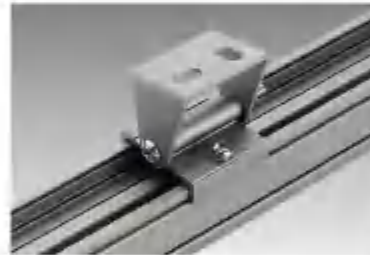

优质铝型材安装支架, 可调节照射角度。
Aluminium alloy mounting bracket adjust the lighting angle.



注塑端盖, 优质硅胶密封。
Injection end cap with quality silicone rubber.

颜色选择 Color Selection



哑光灰铝色 哑光铝本色

适用场合

主要应用于楼宇、桥梁、河道等亮化工程。

The Application of Occasions

Suitable places: Buildings, Bridges, Rivers and Other lighting.

产品特点说明

1. 极简的工业设计造型, 美学与实用的完美结合, 外观和结构专利。
2. 灯体主体部分采用铝型材和高压压铸铝, 表面氧化处理, 防腐蚀、抗老化, 延长使用寿命。
3. 透光罩采用丝印钢化玻璃, 提高了灯具整体的美观程度, 灵活的二次光学透镜配光, 根据实际需要多种光束角选择。
4. 采用高效率、高稳定性恒流驱动电源, 保证了光源的稳定工作, 降低光衰, 延长使用寿命。
5. 灯体表面设计了散热片更有利于通风, 增加散热面积, 迅速散热, 升华了灯具的整体美观程度。
6. 采用硅胶密封结构设计, 有效保证了防护等级IP65。
7. 安装采用可调节安装支架, 安装简洁方便。

Product Description

1. Simple and practical design, Perfect aesthetic and practical union, patented appearance and structure technology.
2. High pressure Aluminium die-cast or alloy body, anodized surface, double anti-corrosion to expand the working life.
3. Tempered glass diffuser, effectively improve the transmission rate of light. Multiple Beam-angle choice.
4. High efficiency constant current driver, ensure the light source is maximum used.
5. Heat sink design on the light body surface, increase the efficiency of heat-dissipation.
6. Using silicone rubber leakproof structure design to ensure the high level of IP rating (IP-65).
7. Adopt adjustable mounting bracket.



配光曲线 Light Distribution Curve

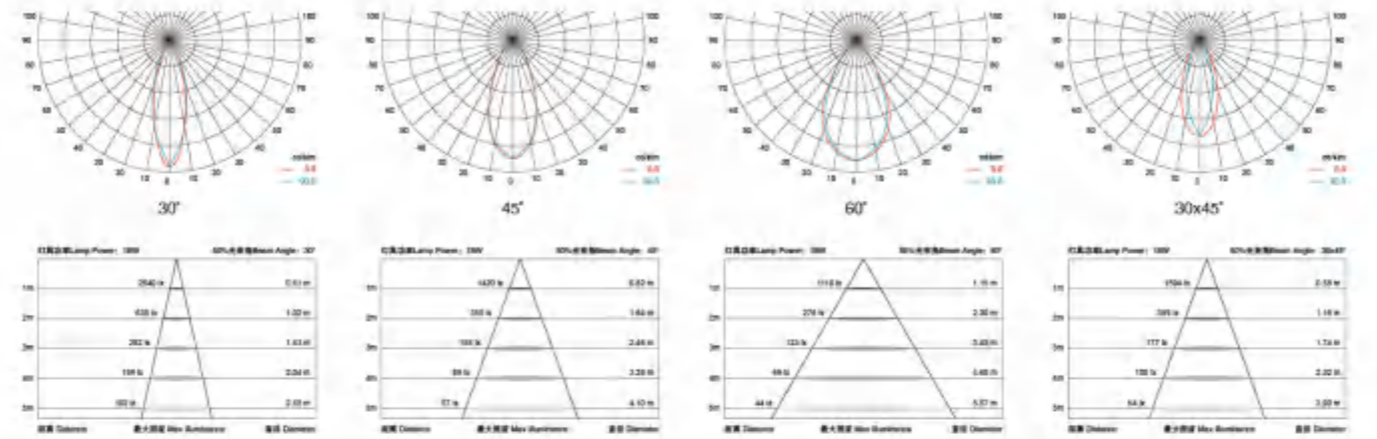

技术参数 Specification

类别	参数	类别	参数	类别	参数
额定功率 Rated Power	18W	光源 / 数量 LED Quantity	LED / 36pcs	输入电压 Input Voltage	DC 24V / AC 220V
色温 Color Temperature	3000K / 4000K / 5700K	50%光束角 50% Beam Angle	30° 45° 60° 30°x45°	控制方式 Control Mode	ON-OFF
使用寿命 Life	>30000H	防护等级 Protection Grade	IP 65	工作环境温度 Temperature of Working Condition	-25°C-50°C
灯具净重 Net Weight	1.1kg	中包规格 Package Specification	65x50x1010mm	外箱规格 / 数量 Outside Box Specifications / Quantity	1000x215x170mm / 9pcs

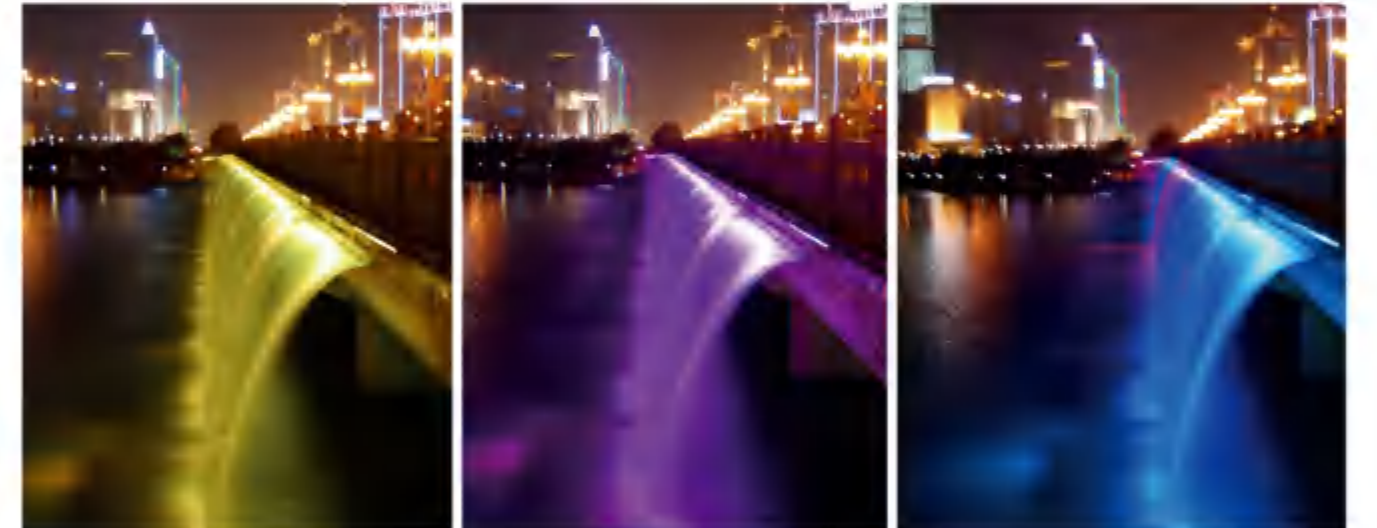

产品尺寸 Product Size



BT9232 Series

专利号 Num: 201630036390.8



BT9232D

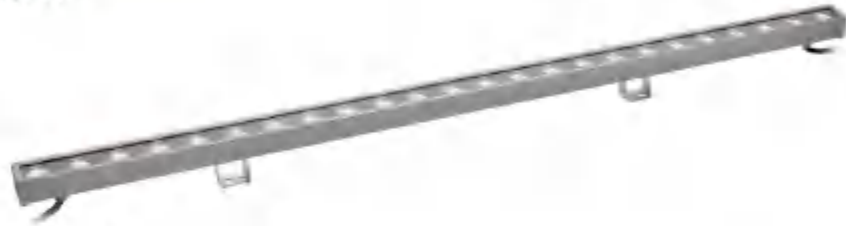

BT9232



适用场合

主要应用于楼宇、桥梁、河道等亮化工程。

The Application of Occasions

Suitable places: Buildings, Bridges, Rivers and Other lighting.

产品特点说明

1. 极简的工业设计造型，美学与实用的完美结合，外观和结构专利。
2. 灯体主体部分采用铝型材和高压压铸铝，表面氧化处理，防腐蚀、抗老化，延长使用寿命。
3. 透光罩采用丝印钢化玻璃，提高了灯具整体的美观程度，灵活的二次光学透镜配光，根据实际需要多种光束角选择。
4. 采用高效率、高稳定性恒流驱动电源，保证了光源的稳定工作，降低光衰，延长使用寿命。
5. 灯体表面设计了散热片更有利于通风，增加散热面积，迅速散热，升华了灯具的整体美观程度。
6. 全灯防水采用结构性防水设计，安装维护简便，控制方式可多种选择：单色、RGB内控、DMX512外控。
7. 采用硅橡胶密封结构设计，有效保证了防护等级IP65。
8. 安装采用可调节安装支架，安装简洁方便。

Product Description

1. Simple and practical design, Perfect aesthetic and practical union, patented appearance and structure technology.
2. High pressure Aluminium die-cast or alloy body, anodized surface, double anti-corrosion to expand the working life.
3. Tempered glass diffuser, effectively improve the transmission rate of light. Multiple Beam-angle choice.
4. High efficiency constant current driver, ensure the light source is maximum used.
5. Heat sink design on the light body surface, increase the efficiency of heat-dissipation.
6. Adopt structural waterproof design, simple installation and repair, Control Mode: Monochrome control; RGB inner control; DMX512 external control.
7. Using silicone rubber leakproof structure design to ensure the high level of IP rating (IP:65).
8. Adopt adjustable mounting bracket.



丝印超白钢化玻璃，提升美观程度。
Silk-printing ultrawhite tempered glass.



专利性结构型防水，提升卖点和档次。
Patented water-proof construction.



优质铝型材安装支架，可调节照射角度。
Aluminium alloy mounting bracket adjust the lighting angle.



压铸端盖，优质硅胶密封。
Aluminium die-cast end cap with quality silicone rubber.

颜色选择 Color Selection

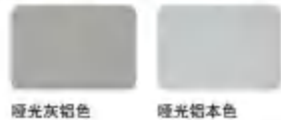

配光曲线 Light Distribution Curve

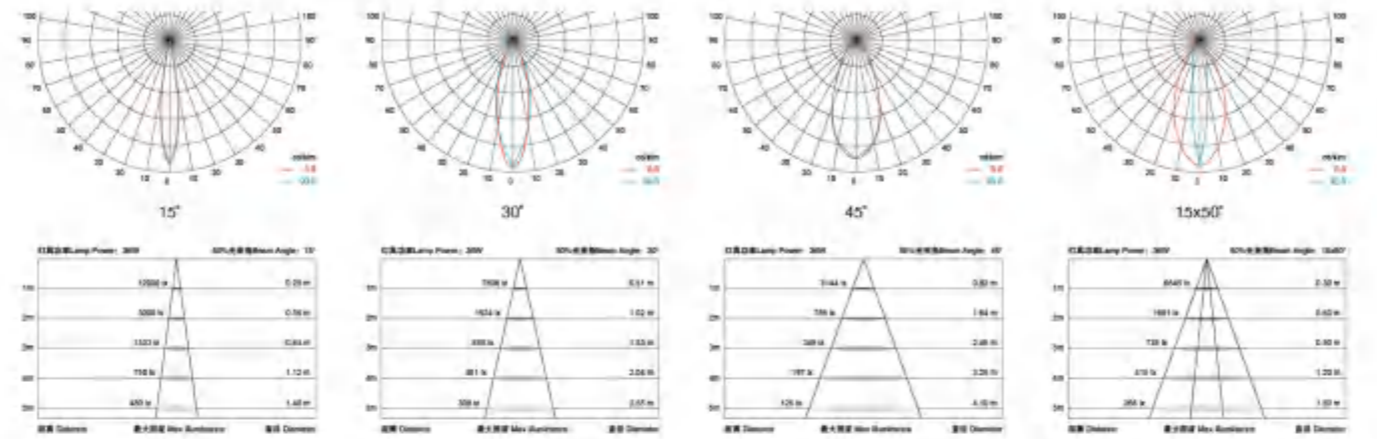

技术参数 Specification

主要参数 (Main Parameters)	数值 (Value)	说明 (Description)	备注 (Remarks)	其他 (Others)	备注 (Remarks)
额定功率 (Rated Power)	36W	光源 / 数量 (LED Quantity)	LED / 24pcs	输入电压 (Input Voltage)	DC 24V / AC 220V
色温 (Color Temperature)	3000K / 4000K / 5700K / RGB	50% 光束角 (50% Beam Angle)	15° 30° 45° 15°x50°	控制方式 (Control Mode)	ON-OFF / DMX512
使用寿命 (Life)	>30000H	防护等级 (Protection Grade)	IP 65	工作环境温度 (Temperature of Working Condition)	-25°C~50°C
灯具净重 (Net Weight)	1.5kg	中包规格 (Package Specification)	65x95x1010mm	外箱规格 / 数量 (Outside Box Specifications / Quantity)	1000x215x185mm / 9pcs



产品尺寸 Product Size



BT9231 Series

专利号 Num: 201630036393.1



BT9231D



BT9231



适用场合

主要应用于楼宇、桥梁、河道等亮化工程。

The Application of Occasions

Suitable places: Buildings, Bridges, Rivers and Other lighting.

产品特点说明

1. 极简的工业设计造型，美学与实用的完美结合，外观和结构专利。
2. 灯体主体部分采用铝型材和高压压铸铝，表面氧化处理，防腐蚀、抗老化，延长使用寿命。
3. 透光罩采用丝印钢化玻璃，提高了灯具整体的美观程度，灵活的二次光学透镜配光，根据实际需要多种光束角选择。
4. 采用高效率、高稳定性恒流驱动电源，保证了光源的稳定工作，降低光衰，延长使用寿命。
5. 灯体表面设计了散热片更有利于通风，增加散热面积，迅速散热，升华了灯具的整体美观程度。
6. 全灯防水采用结构性防水设计，安装维护简便，控制方式可多种选择：单色、RGB内控、DMX512外控。
7. 采用硅橡胶密封结构设计，有效保证了防护等级IP65。
8. 安装采用可调节安装支架，安装简洁方便。

Product Description

1. Simple and practical design, Perfect aesthetic and practical union, patented appearance and structure technology.
2. High pressure Aluminium die-cast or alloy body, anodized surface, double anti-corrosion to expand the working life.
3. Tempered glass diffuser, effectively improve the transmission rate of light. Multiple Beam-angle choice.
4. High efficiency constant current driver, ensure the light source is maximum used.
5. Heat sink design on the light body surface, increase the efficiency of heat-dissipation.
6. Adopt structural waterproof design, simple installation and repair, Control Mode: Monochrome control; RGB inner control; DMX512 external control.
7. Using silicone rubber leakproof structure design to ensure the high level of IP rating (IP:65).
8. Adopt adjustable mounting bracket.



丝印超白钢化玻璃，提升美观程度。
Silk-printing ultrawhite tempered glass.



专利性结构型防水，提升卖点和档次。
Patented water-proof structure.



优质铝型材安装支架，可调节照射角度。
Aluminium alloy mounting bracket adjust the lighting angle.



压铸端盖，优质硅胶密封。
Aluminium die-cast end cap with quality silicone rubber.

颜色选择 Color Selection

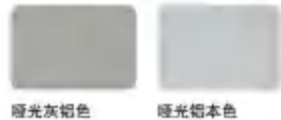

配光曲线 Light Distribution Curve

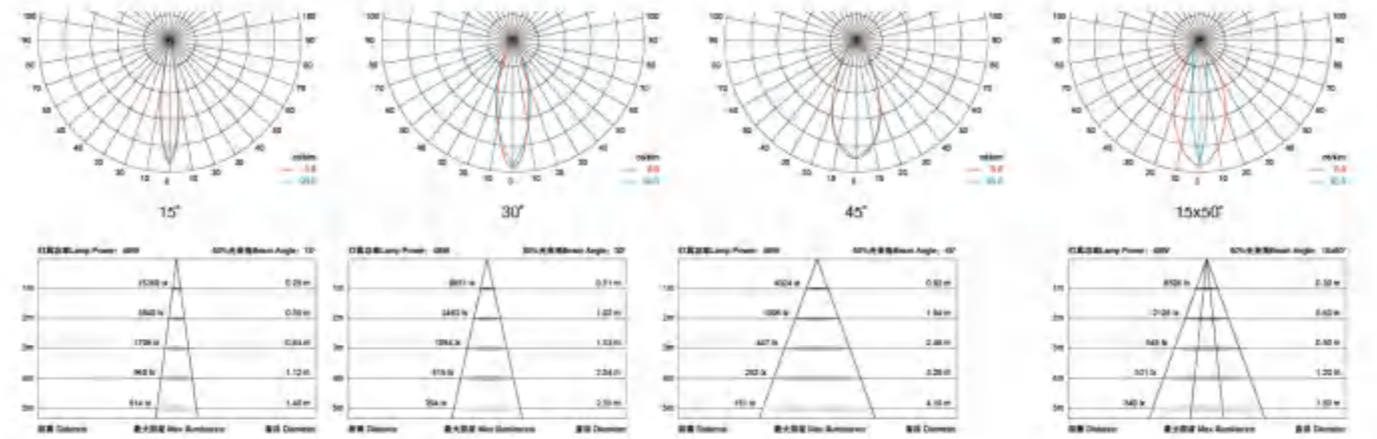

技术参数 Specification

项目 (Item)	参数 (Parameter)	项目 (Item)	参数 (Parameter)
额定功率 (Rated Power)	48W	光源 / 数量 (LED Quantity)	LED / 24pcs
色温 (Color Temperature)	3000K / 4000K / 5700K / RGB	50% 光束角 (50% Beam Angle)	15° / 30° / 45° / 15°x50°
使用寿命 (Life)	>30000H	防护等级 (Protection Grade)	IP 65
灯具净重 (Net Weight)	1.9kg	中包规格 (Package Specification)	65x70x1010mm
		输入电压 (Input Voltage)	DC 24V / AC 220V
		控制方式 (Control Mode)	ON-OFF / DMX512
		工作环境温度 (Temperature of Working Condition)	-25°C ~ 50°C
		外箱规格 / 数量 (Outside Box Specification / Quantity)	1000x215x230mm / 9pcs



产品尺寸 Product Size



BT9237 Series

专利设计 DESIGN PATENT



BT9237D



BT9237



适用场合

主要应用于楼宇、桥梁、河道等亮化工程。

The Application of Occasions

Suitable places: Buildings, Bridges, Rivers and Other lighting.

产品特点说明

1. 极简的工业设计造型，美学与实用的完美结合，外观和结构专利。
2. 灯体主体部分采用铝型材和高压压铸铝，表面氧化处理，防腐蚀、抗老化，延长使用寿命。
3. 透光罩采用丝印钢化玻璃，提高了灯具整体的美观程度，灵活的二次光学透镜配光，根据实际需要多种光束角选择。
4. 采用高效率、高稳定性恒流驱动电源，保证了光源的稳定工作，降低光衰，延长使用寿命。
5. 灯体表面设计了散热片更有利于通风，增加散热面积，迅速散热，升华了灯具的整体美观程度。
6. 全灯防水采用结构性防水设计，安装维护简便，控制方式可多种选择：单色、RGB内控、DMX512外控。
7. 采用硅橡胶密封结构设计，有效保证了防护等级IP65。
8. 安装采用可调节安装支架，安装简洁方便。

Product Description

1. Simple and practical design, Perfect aesthetic and practical union, patented appearance and structure technology.
2. High pressure Aluminium die-cast or alloy body, anodized surface, double anti-corrosion to expand the working life.
3. Tempered glass diffuser, effectively improve the transmission rate of light. Multiple Beam-angle choice.
4. High efficiency constant current driver, ensure the light source is maximum used.
5. Heat sink design on the light body surface, increase the efficiency of heat-dissipation.
6. Adopt structural waterproof design, simple installation and repair, Control Mode: Monochrome control; RGB inner control; DMX512 external control.
7. Using silicone rubber leakproof structure design to ensure the high level of IP rating (IP:65).
8. Adopt adjustable mounting bracket.



丝印超白钢化玻璃，提升美观程度。
Silk-printing ultrawhite tempered glass.



专利性结构型防水，提升卖点和档次。
Patented water-proof construction.



优质铝型材安装支架，可调节照射角度。
Aluminium alloy mounting bracket adjust the lighting angle.



压铸端盖，优质硅胶密封。
Aluminium die-cast end cap with quality silicone rubber.

颜色选择 Color Selection

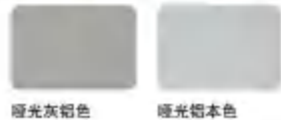

配光曲线 Light Distribution Curve

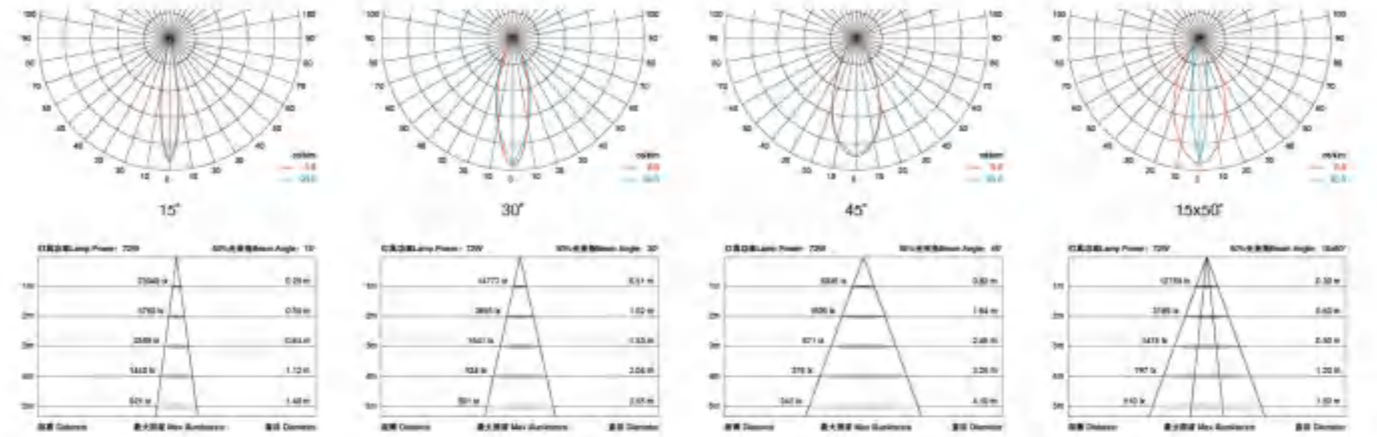

技术参数 Specification

项目	参数	项目	参数	项目	参数
额定功率 Rated Power	72W	光源 / 数量 LED Quantity	LED / 36pcs	输入电压 Input Voltage	DC 24V / AC 220V
色温 Color Temperature	3000K / 4000K / 5700K / RGB	50% 光束角 50% Beam Angle	15° 30° 45° 15°x50°	控制方式 Control Mode	ON-OFF / DMX512
使用寿命 Life	>30000H	防护等级 Protection Grade	IP 65	工作环境温度 Temperature of Working Condition	-25°C-50°C
灯具净重 Net Weight	2.9kg	中包规格 Package Specification	96x95x1010mm	外箱规格 / 数量 Outside Box Specifications / Quantity	1000x300x210mm / 9pcs



产品尺寸 Product Size

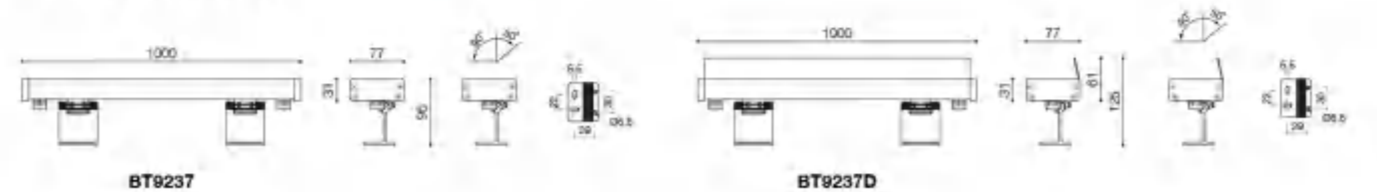

BT9230 Series

专利号 Num: 201630036396.5



BT9230D



BT9230



适用场合

主要应用于楼宇、桥梁、河道等亮化工程。

The Application of Occasions

Suitable places: Buildings, Bridges, Rivers and Other lighting.

产品特点说明

1. 极简的工业设计造型，美学与实用的完美结合，外观和结构专利。
2. 灯体主体部分采用铝型材和高压压铸铝，表面氧化处理，防腐蚀、抗老化，延长使用寿命。
3. 透光罩采用丝印钢化玻璃，提高了灯具整体的美观程度，灵活的二次光学透镜配光，根据实际需要多种光束角选择。
4. 采用高效率、高稳定性恒流驱动电源，保证了光源的稳定工作，降低光衰，延长使用寿命。
5. 灯体表面设计了散热片更有利于通风，增加散热面积，迅速散热，升华了灯具的整体美观程度。
6. 全灯防水采用结构性防水设计，安装维护简便，控制方式可多种选择：单色、RGB内控、DMX512外控。
7. 采用硅橡胶密封结构设计，有效保证了防护等级IP65。
8. 安装采用可调节安装支架，安装简洁方便。

Product Description

1. Simple and practical design, Perfect aesthetic and practical union, patented appearance and structure technology.
2. High pressure Aluminium die-cast or alloy body, anodized surface, double anti-corrosion to expand the working life.
3. Tempered glass diffuser, effectively improve the transmission rate of light. Multiple Beam-angle choice.
4. High efficiency constant current driver, ensure the light source is maximum used.
5. Heat sink design on the light body surface, increase the efficiency of heat-dissipation.
6. Adopt structural waterproof design, simple installation and repair, Control Mode: Monochrome control; RGB inner control; DMX512 external control.
7. Using silicone rubber leakproof structure design to ensure the high level of IP rating (IP65).
8. Adopt adjustable mounting bracket.

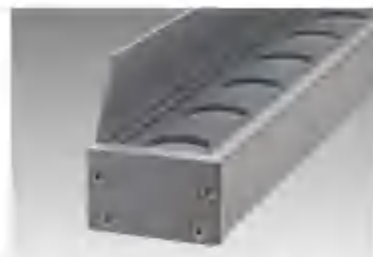

丝印超白钢化玻璃，提升美观程度。
Silk-printing ultrawhite tempered glass.



专利性结构型防水，提升卖点和档次。
Patented water-proof construction.



优质铝型材安装支架，可调节照射角度。
Aluminium alloy mounting bracket adjust the lighting angle.



压铸端盖，优质硅胶密封。
Aluminium die-cast end cap with quality silicone rubber.

颜色选择 Color Selection

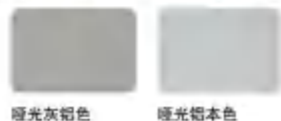

配光曲线 Light Distribution Curve

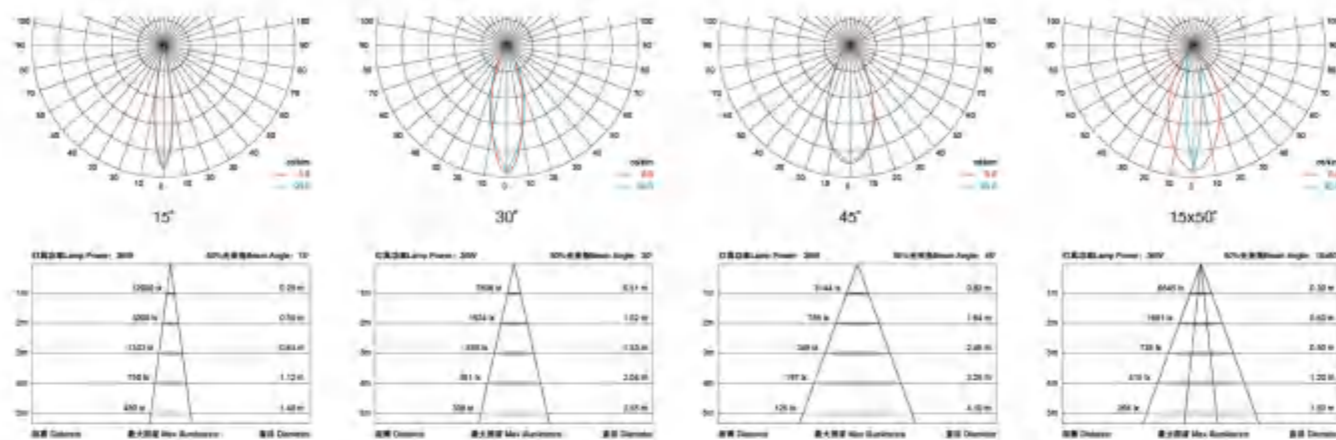

技术参数 Specification

项目 Item	参数 Parameter	材料 Material	功率 Power	类型 Type	备注 Remark
额定功率 Rated Power	36W	光源 / 数量 LED Quantity	LED / 24pcs	输入电压 Input Voltage	DC 24V / AC 220V
色温 Color Temperature	3000K / 4000K / 5700K / RGB	50%光束角 50% Beam Angle	15° 30° 45° 15°x50°	控制方式 Control Mode	ON-OFF / DMX512
使用寿命 Life	>30000H	防护等级 Protection Grade	IP 65	工作环境温度 Temperature of Working Condition	-25°C~50°C
灯具净重 Net Weight	2.9kg	中包规格 Package Specification	96x95x1010mm	外箱规格 / 数量 Outside Box Specifications / Quantity	1000x210x150mm / 4pcs



产品尺寸 Product Size

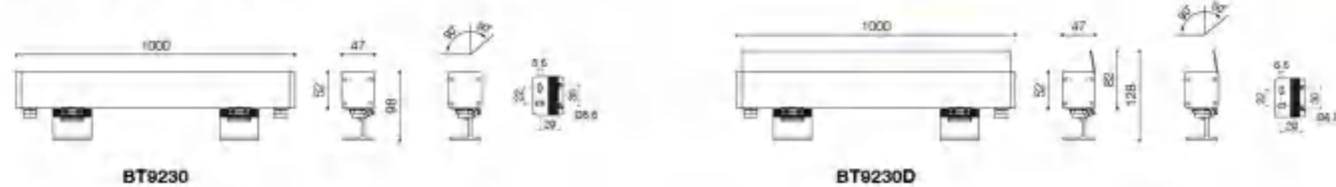

BT9240 Series

专利设计 DESIGN PATENT



BT9240D

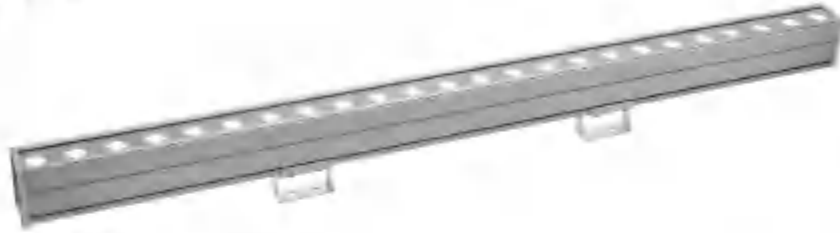

BT9240



适用场合

主要应用于楼宇、桥梁、河道等亮化工程。

The Application of Occasions

Suitable places: Buildings, Bridges, Rivers and Other lighting.

产品特点说明

1. 极简的工业设计造型，美学与实用的完美结合，外观和结构专利。
2. 灯体主体部分采用铝型材和高压压铸铝，表面氧化处理，防腐蚀、抗老化，延长使用寿命。
3. 透光罩采用丝印钢化玻璃，提高了灯具整体的美观程度，灵活的二次光学透镜配光，根据实际需要多种光束角选择。
4. 采用高效率、高稳定性恒流驱动电源，保证了光源的稳定工作，降低光衰，延长使用寿命。
5. 灯体表面设计了散热片更有利于通风，增加散热面积，迅速散热，升华了灯具的整体美观程度。
6. 全灯防水采用结构性防水设计，安装维护简便，控制方式可多种选择：单色、RGB内控、DMX512外控。
7. 采用硅橡胶密封结构设计，有效保证了防护等级IP65。
8. 安装采用可调节安装支架，安装简洁方便。

Product Description

1. Simple and practical design, Perfect aesthetic and practical union, patented appearance and structure technology.
2. High pressure Aluminium die-cast or alloy body, anodized surface, double anti-corrosion to expand the working life.
3. Tempered glass diffuser, effectively improve the transmission rate of light. Multiple Beam-angle choice.
4. High efficiency constant current driver, ensure the light source is maximum used.
5. Heat sink design on the light body surface, increase the efficiency of heat-dissipation.
6. Adopt structural waterproof design, simple installation and repair, Control Mode: Monochrome control; RGB inner control; DMX512 external control.
7. Using silicone rubber leakproof structure design to ensure the high level of IP rating (IP65).
8. Adopt adjustable mounting bracket.



专利性结构型防水，提升卖点和档次。
Patented water-proof construncture.



电源暗藏式安装结构。
Power hidden mounting structure.

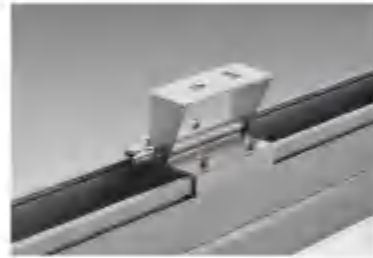

优质铝型材安装支架，可调节照射角度。
Aluminium alloy mounting bracket adjust the lighting angle.



压铸端盖，优质硅胶密封。
Aluminium die-cast end cap with quality silicone rubber.

颜色选择 Color Selection

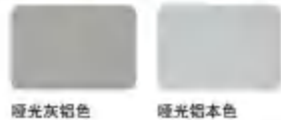

配光曲线 Light Distribution Curve

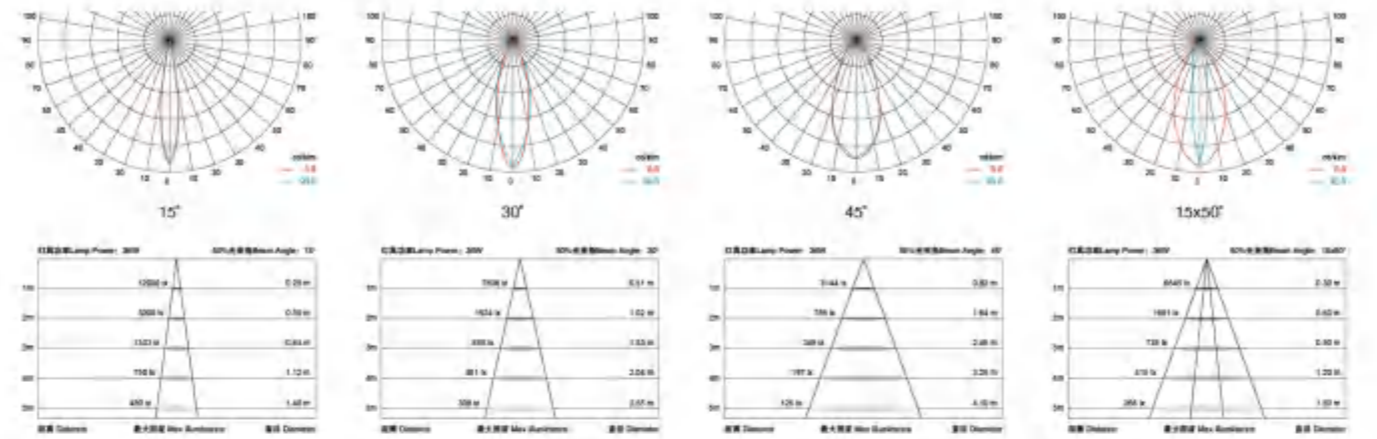

技术参数 Specification

主要参数	数值	类别	参数	数值	
额定功率 Rated Power	36W	光源 / 数量 LED Quantity	LED / 24pcs	输入电压 Input Voltage	DC 24V / AC 220V
色温 Color Temperature	3000K / 4000K / 5700K / RGB	50%光束角 50% Beam Angle	15° 30° 45° 15°x50°	控制方式 Control Mode	ON-OFF / DMX512
使用寿命 Life	>30000H	防护等级 Protection Grade	IP 65	工作环境温度 Temperature of Working Condition	-25°C-50°C
灯具净重 Net Weight	2.9kg	中包规格 Package Specification	96x70x1010mm	外箱规格 / 数量 Outside Box Specifications / Quantity	1000x300x160mm / 8pcs



产品尺寸 Product Size

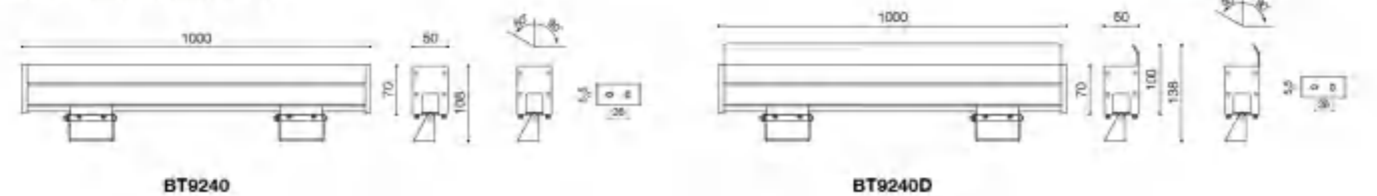

BT9241 Series

专利设计 DESIGN PATENT



BT9241D



BT9241



适用场合

主要应用于楼宇、桥梁、河道等亮化工程。

The Application of Occasions

Suitable places: Buildings, Bridges, Rivers and Other lighting.

产品特点说明

1. 极简的工业设计造型，美学与实用的完美结合，外观和结构专利。
2. 灯体主体部分采用铝型材和高压压铸铝，表面氧化处理，防腐蚀、抗老化，延长使用寿命。
3. 透光罩采用钢化玻璃，提高了灯具整体的美观程度，灵活的二次光学透镜配光，根据实际需要多种光束角选择。
4. 采用高效率、高稳定性恒流驱动电源，保证了光源的稳定工作，降低光衰，延长使用寿命。
5. 灯体表面设计了散热片更有利于通风，增加散热面积，迅速散热，升华了灯具的整体美观程度。
6. 全灯防水采用结构性防水设计，安装维护简便，控制方式可多种选择：单色、RGB内控、DMX512外控。
7. 采用硅橡胶密封结构设计，有效保证了防护等级IP65。
8. 安装采用可调节安装支架，安装简洁方便。

Product Description

1. Simple and practical design, Perfect aesthetic and practical union, patented appearance and structure technology.
2. High pressure Aluminium die-cast or alloy body, anodized surface, double anti-corrosion to expand the working life.
3. Tempered glass diffuser, effectively improve the transmission rate of light. Multiple Beam-angle choice.
4. High efficiency constant current driver, ensure the light source is maximum used.
5. Heat sink design on the light body surface, increase the efficiency of heat-dissipation.
6. Adopt structural waterproof design, simple installation and repair, Control Mode: Monochrome control; RGB inner control; DMX512 external control.
7. Using silicone rubber leakproof structure design to ensure the high level of IP rating (IP65).
8. Adopt adjustable mounting bracket.

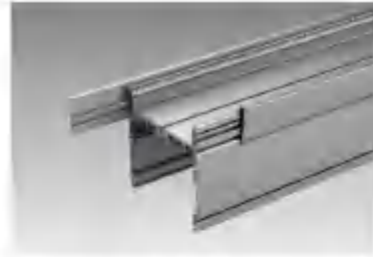

专利性结构型防水，提升卖点和档次。
Patented water-proof structure.



电源暗藏式安装结构。
Power hidden mounting structure.

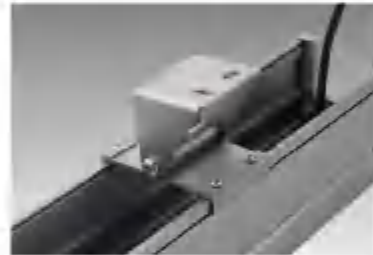

优质铝型材安装支架，可调节照射角度。
Aluminium alloy mounting bracket adjust the lighting angle.



压铸端盖，优质硅胶密封。
Aluminium die-cast end cap with quality silicone rubber.

颜色选择 Color Selection



哑光灰铝色 哑光铝本色

配光曲线 Light Distribution Curve

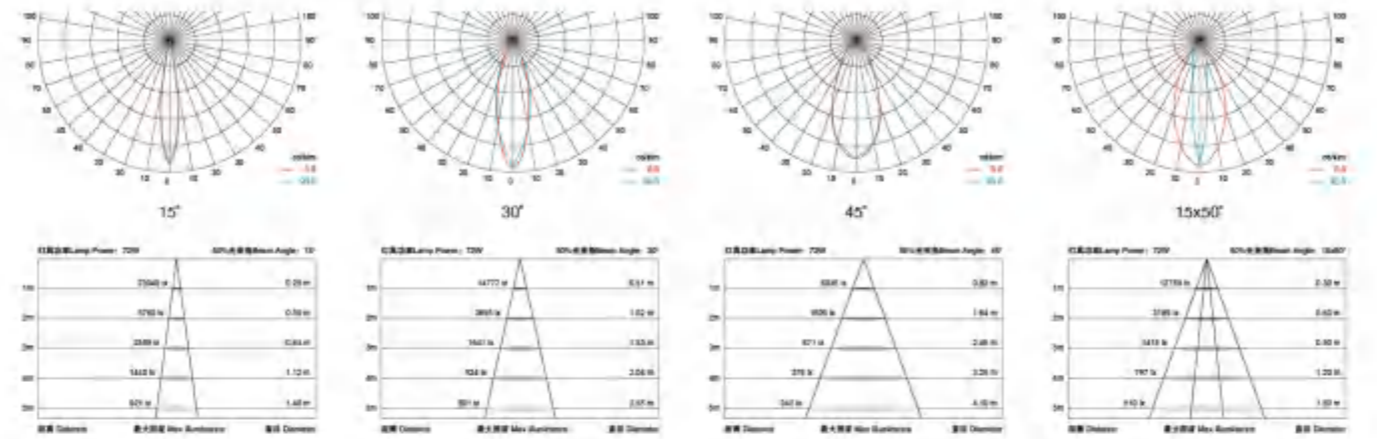

技术参数 Specification

主要参数	数值	主要参数	数值	主要参数	数值
额定功率 Rated Power	72W	光源 / 数量 LED Quantity	LED / 36pcs	输入电压 Input Voltage	DC 24V / AC 220V
色温 Color Temperature	3000K / 4000K / 5700K / RGB	50%光束角 50% Beam Angle	15° 30° 45° 15°x50°	控制方式 Control Mode	ON-OFF / DMX512
使用寿命 Life	>30000H	防护等级 Protection Grade	IP 65	工作环境温度 Temperature of Working Condition	-25°C~50°C
灯具净重 Net Weight	4.8kg	中包规格 Package Specification	135x110x1010mm	外箱规格 / 数量 Outside Box Specification / Quantity	1030x290x240mm / 4pcs



产品尺寸 Product Size

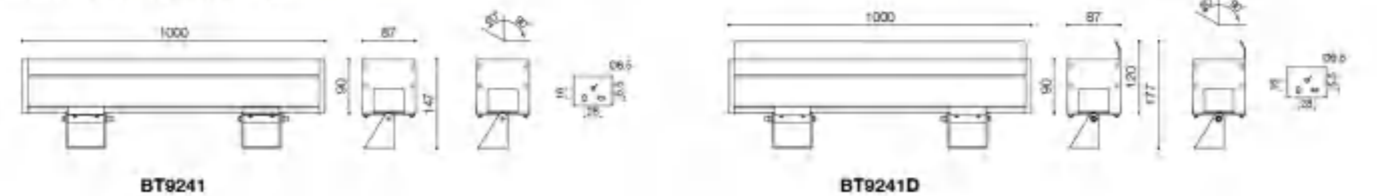

BT9235 Series

专利号 Num: 201630151768.9



BT9235D



BT9235



丝印超白钢化玻璃, 提升美观程度。
Silk-printing ultrawhite tempered glass.



专利性结构型防水, 提升卖点和档次。
Patented water-proof construction.



优质铝型材安装支架, 可调节照射角度。
Aluminium alloy mounting bracket adjust the lighting angle.



压铸端盖, 优质硅胶密封。
Aluminium die-cast end cap with quality silicone rubber.

颜色选择 Color Selection



哑光灰铝色 哑光铝本色

适用场合

主要应用于楼宇、桥梁、河道等亮化工程。

The Application of Occasions

Suitable places: Buildings, Bridges, Rivers and Other lighting.

产品特点说明

1. 极简的工业设计造型, 美学与实用的完美结合, 外观和结构专利。
2. 灯体主体部分采用铝型材和高压压铸铝, 表面氧化处理, 防腐蚀、抗老化, 延长使用寿命。
3. 透光罩采用丝印钢化玻璃, 提高了灯具整体的美观程度, 灵活的二次光学透镜配光, 根据实际需要多种光束角选择。
4. 采用高效率、高稳定性恒流驱动电源, 保证了光源的稳定工作, 降低光衰, 延长使用寿命。
5. 灯体表面设计了散热片更有利于通风, 增加散热面积, 迅速散热, 升华了灯具的整体美观程度。
6. 全灯防水采用结构性防水设计, 安装维护简便, 控制方式可多种选择: 单色、RGB内控、DMX512外控。
7. 采用硅胶橡胶密封结构设计, 有效保证了防护等级IP65。
8. 安装采用可调节安装支架, 安装简洁方便。

Product Description

1. Simple and practical design, Perfect aesthetic and practical union, patented appearance and structure technology.
2. High pressure Aluminium die-cast or alloy body, anodized surface, double anti-corrosion to expand the working life.
3. Tempered glass diffuser, effectively improve the transmission rate of light. Multiple Beam-angle choice.
4. High efficiency constant current driver, ensure the light source is maximum used.
5. Heat sink design on the light body surface, increase the efficiency of heat-dissipation.
6. Adopt structural waterproof design, simple installation and repair, Control Mode: Monochrome control; RGB inner control; DMX512 external control.
7. Using silicone rubber leakproof structure design to ensure the high level of IP rating (IP65).
8. Adopt adjustable mounting bracket.



配光曲线 Light Distribution Curve

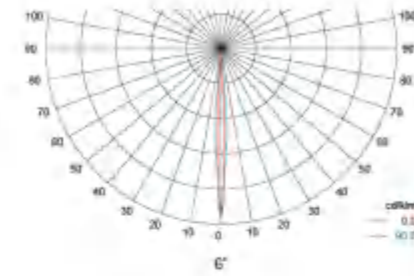

等照度图 Illumination Map

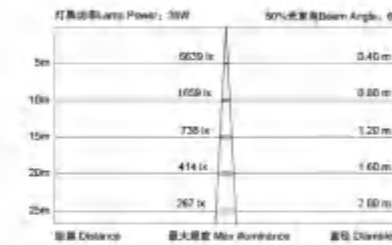

技术参数 Specification

类别	Product Code	参数 Parameter
额定功率	Rated Power	36W
光源 / 数量	LED Quantity	LED / 18pcs
输入电压	Input Voltage	DC 24V / AC 220V
色温	Color Temperature	3000K / 4000K / 5700K / RGB
50%光束角	50% Beam Angle	6°
控制方式	Control Mode	ON-OFF / DMX512
使用寿命	Life	>30000H
防护等级	Protection Grade	IP 65
工作环境温度	Temperature of Working Condition	-25°C-50°C
灯具净重	Net Weight	3.4kg
中包规格	Package Specification	100x75x1020mm
外包装规格 / 数量	Outside Box Specifications / Quantity	1050x245x220mm / 8pcs



产品尺寸 Product Size



BT9236

专利设计 DESIGN PATENT

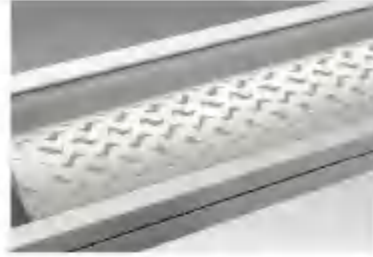

水波纹金属管，专利性。
Corrugated metal pipe, patent.



专利性结构型防水，提升卖点和档次。
Patented water-proof structure.



优质铝型材安装支架，可调节照射角度。
Aluminium alloy mounting bracket adjust the lighting angle.



压铸端盖，优质硅胶密封。
Aluminium die-cast end cap with quality silicone rubber.

颜色选择 Color Selection

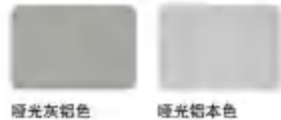

适用场合

主要应用于楼宇、桥梁、河道等亮化工程。

The Application of Occasions

Suitable places: Buildings, Bridges, Rivers and Other lighting.

产品特点说明

1. 极简的工业设计造型，美学与实用的完美结合，外观和结构专利。
2. 灯体主体部分采用铝型材和高压压铸铝，表面氧化处理，防腐蚀、抗老化，延长使用寿命。
3. 透光罩采用钢化玻璃，提高了灯具整体的美观程度，灵活的二次光学透镜配光，根据实际需要多种光束角选择。
4. 采用高效率、高稳定性恒流驱动电源，保证了光源的稳定工作，降低光衰，延长使用寿命。
5. 灯体表面设计了散热片更有利于通风，增加散热面积，迅速散热，升华了灯具的整体美观程度。
6. 全灯防水采用结构性防水设计，安装维护简便，控制方式可多种选择：单色、RGB内控、DMX512外控。
7. 采用硅胶密封结构设计，有效保证了防护等级IP65。
8. 安装采用可调节安装支架，安装简洁方便。

Product Description

1. Simple and practical design, Perfect aesthetic and practical union, patented appearance and structure technology.
2. High pressure Aluminium die-cast or alloy body, anodized surface, double anti-corrosion to expand the working life.
3. Tempered glass diffuser, effectively improve the transmission rate of light. Multiple Beam-angle choice.
4. High efficiency constant current driver, ensure the light source is maximum used.
5. Heat sink design on the light body surface, increase the efficiency of heat-dissipation.
6. Adopt structural waterproof design, simple installation and repair, Control Mode: Monochrome control; RGB inner control; DMX512 external control.
7. Using silicone rubber leakproof structure design to ensure the high level of IP rating (IP65).
8. Adopt adjustable mounting bracket.



配光曲线 Light Distribution Curve

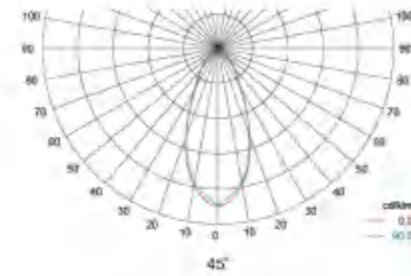

等照度图 Illumination Map

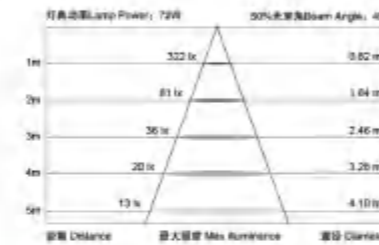

技术参数 Specification

类别	Product Code	参 数 Parameter
额定功率	Rated Power	72W
光源 / 数量	LED Quantity	LED / 36pcs
输入电压	Input Voltage	DC 24V / AC 220V
色温	Color Temperature	6500K
50%光束角	50% Beam Angle	45°
控制方式	Control Mode	ON-OFF / DMX512
灯光效果	Lighting Effect	水波纹动态光
电机转速 / 分	Motor Speed / Min	2.5转
电机功率	Motor Power	3W
使用寿命	Life	>30000H
防护等级	Protection Grade	IP 65
工作环境温度	Temperature of Working Condition	-25°C-50°C
灯具净重	Net Weight	3.6kg
中包规格	Package Specification	125x80x1020mm
外箱规格 / 数量	Outside Box Specifications / Quantity	1050x280x190mm / 4pcs



产品尺寸 Product Size



BT9246 水纹盾

专利设计 DESIGN PATENT

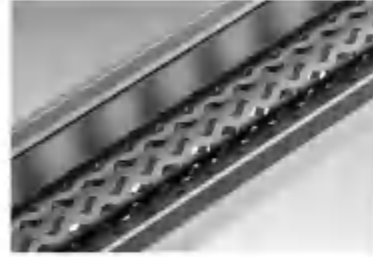

水波纹金属管，专利性。
Corrugated metal pipe, patent.



专利性结构型防水，提升卖点和档次。
Patented water-proof structure.

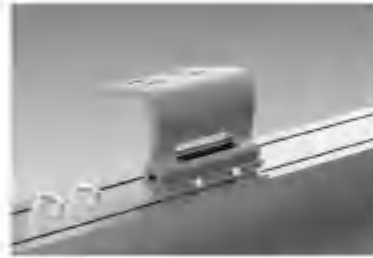

优质铝型材安装支架，可调节照射角度。
Aluminium alloy mounting bracket adjust the lighting angle.



压铸端盖，优质硅胶密封。
Aluminium die-cast end cap with quality silicone rubber.

颜色选择 Color Selection

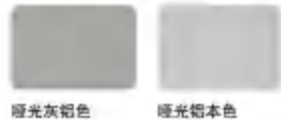

适用场合

主要应用于楼宇、桥梁、河道等亮化工程。

The Application of Occasions

Suitable places: Buildings, Bridges, Rivers and Other lighting.

产品特点说明

1. 极简的工业设计造型，美学与实用的完美结合，外观和结构专利。
2. 灯体主体部分采用铝型材和高压压铸铝，表面氧化处理，防腐蚀、抗老化，延长使用寿命。
3. 透光罩采用钢化玻璃，提高了灯具整体的美观程度，灵活的二次光学透镜配光，根据实际需要多种光束角选择。
4. 采用高效率、高稳定性恒流驱动电源，保证了光源的稳定工作，降低光衰，延长使用寿命。
5. 灯体表面设计了散热片更有利于通风，增加散热面积，迅速散热，升华了灯具的整体美观程度。
6. 全灯防水采用结构性防水设计，安装维护简便，控制方式可多种选择：单色、RGB内控、DMX512外控。
7. 采用硅胶密封结构设计，有效保证了防护等级IP65。
8. 安装采用可调节安装支架，安装简洁方便。

Product Description

1. Simple and practical design, Perfect aesthetic and practical union, patented appearance and structure technology.
2. High pressure Aluminium die-cast or alloy body, anodized surface, double anti-corrosion to expand the working life.
3. Tempered glass diffuser, effectively improve the transmission rate of light. Multiple Beam-angle choice.
4. High efficiency constant current driver, ensure the light source is maximum used.
5. Heat sink design on the light body surface, increase the efficiency of heat-dissipation.
6. Adopt structural waterproof design, simple installation and repair, Control Mode: Monochrome control; RGB inner control; DMX512 external control.
7. Using silicone rubber leakproof structure design to ensure the high level of IP rating (IP65).
8. Adopt adjustable mounting bracket.



配光曲线 Light Distribution Curve

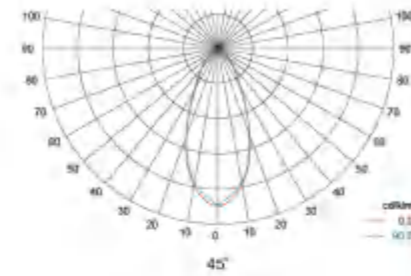

等照度图 Illumination Map

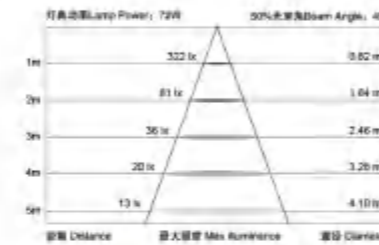

技术参数 Specification

类别	Product Code	参 数 Parameter
额定功率	Rated Power	72W
光源 / 数量	LED Quantity	LED / 36pcs
输入电压	Input Voltage	DC 24V / AC 220V
色温	Color Temperature	6500K
50%光束角	50% Beam Angle	45°
控制方式	Control Mode	ON-OFF / DMX512
灯光效果	Lighting Effect	水波纹动态光
电机转速 / 分	Motor Speed / Min	2.5转
电机功率	Motor Power	3W
使用寿命	Life	>30000H
防护等级	Protection Grade	IP 65
工作环境温度	Temperature of Working Condition	-25°C-50°C
灯具净重	Net Weight	6.1kg
中包规格	Package Specification	140x100x1020mm
外箱规格 / 数量	Outside Box Specifications / Quantity	1050x300x230mm / 4pcs



产品尺寸 Product Size

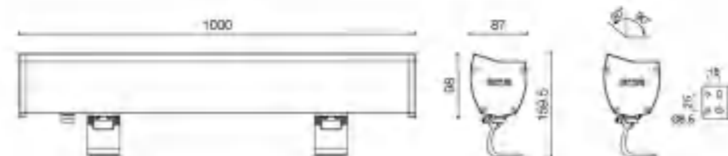

BT9239 引路星

专利设计 DESIGN PATENT



BT9239L



BT9239M



专业二次光学透镜配光。
Professional two optical lens.



专利性结构型防水，提升卖点和档次。
Patented water-proof construction.



优质铝材可滑动安装支架。
High quality aluminium sliding mounting bracket.

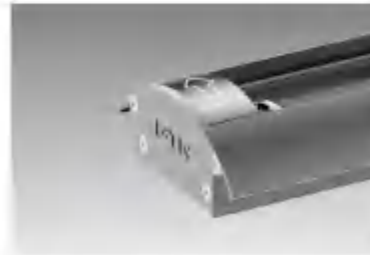

压铸端盖，优质硅胶密封。
Aluminium die-cast end cap with quality silicone rubber.

适用场合

主要应用于楼宇、桥梁、河道等亮化工程。

The Application of Occasions

Suitable places: Buildings, Bridges, Rivers and Other lighting.

产品特点说明

1. 极简的工业设计造型，美学与实用的完美结合，外观和结构专利。
2. 灯体主体部分采用铝型材和高压压铸铝，表面氧化处理，防腐蚀、抗老化，延长使用寿命。
3. 透光罩采用进口PC材质，提高了灯具整体的美观程度，专业二次光学透镜配光。
4. 采用高效率、高稳定性恒流驱动电源，保证了光源的稳定工作，降低光衰，延长使用寿命。
5. 灯体表面设计了散热片更有利于通风，增加散热面积，迅速散热，升华了灯具的整体美观程度。
6. 全灯防水采用结构性防水设计，安装维护简便。
7. 采用硅胶橡胶密封结构设计，有效保证了防护等级IP65。
8. 安装采用可调节安装支架，安装简洁方便。

Product Description

1. Simple and practical design, Perfect aesthetic and practical union, patented appearance and structure technology.
2. High pressure Aluminium die-cast or alloy body, anodized surface, double anti-corrosion to expand the working life.
3. Imported PC diffuser, effectively improve the transmission rate of light. Multiple Beam-angle choice.
4. High efficiency constant current driver, ensure the light source is maximum used.
5. Heat sink design on the light body surface, increase the efficiency of heat-dissipation.
6. Adopt structural waterproof design, simple installation and repair.
7. Using silicone rubber leakproof structure design to ensure the high level of IP rating (IP:65).
8. Adopt adjustable mounting bracket.

CE RoHS CCC IP65

配光曲线 Light Distribution Curve

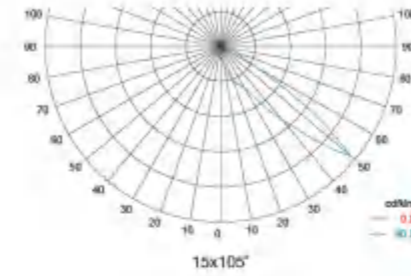

等照度图 Illumination Map

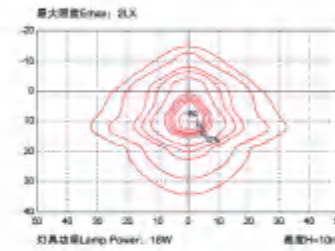

技术参数 Specification

类别	Product Code	参数 Parameter
额定功率	Rated Power	18W
光源 / 数量	LED Quantity	LED / 18pcs
输入电压	Input Voltage	DC 24V
色温	Color Temperature	3000K / 4000K / 5700K
50%光束角	50% Beam Angle	15x105°
控制方式	Control Mode	ON-OFF
使用寿命	Life	>30000H
防护等级	Protection Grade	IP 65
工作环境温度	Temperature of Working Condition	-25°C~50°C
灯具净重	Net Weight	1.9kg
中包规格	Package Specification	90x70x1020mm
外包装规格 / 数量	Outside Box Specifications / Quantity	1050x230x210mm / 6pcs

颜色选择 Color Selection

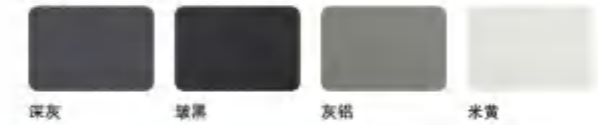

产品尺寸 Product Size



BT9224A Series

专利号 Num: 201630151771.0



BT9224AD



BT9224A



遮光板设计, 防止眩光。
Visor design to prevent glare.



装饰盖板设计, 提升美观度。
Decorative cover design to enhance the aesthetic.



防水公母插连接, 便于安装。
Waterproof female plug connection, easy to install.



优质铝型材安装支架, 可调节照射角度。
Aluminium alloy mounting bracket.

适用场合

主要应用于楼宇、桥梁、河道等亮化工程。

The Application of Occasions

Suitable places: Buildings, Bridges, Rivers and Other lighting.

产品特点说明

1. 极简的工业设计造型, 美学与实用的完美结合, 外观和结构专利。
2. 灯体主体部分采用铝型材和高压压铸铝, 表面氧化处理, 防腐蚀、抗老化, 延长使用寿命。
3. 透光罩采用进口PC材质, 加装装饰盖板, 提升美观度。
4. 全灯防水采用结构性防水设计, 安装维护简便, 控制方式可多种选择: 单色、RGB内控、DMX512外控。
5. 采用整体灌胶处理, 有效保证了防护等级IP65。
6. 安装采用可调节安装支架, 安装简洁方便。

Product Description

1. Simple and practical design, Perfect aesthetic and practical union, patented appearance and structure technology.
2. High pressure Aluminium die-cast or alloy body, anodized surface, double anti-corrosion to expand the working life.
3. The transparent cover is made of imported PC material, and the decorative cover plate is added to enhance the aesthetic appearance.
4. Adopt structural waterproof design, simple installation and repair, Control Mode: Monochrome control; RGB inner control; DMX512 external control.
5. Whole pouring treatment to ensure the high level of IP rating (IP-65).
6. Adopt adjustable mounting bracket.

CE RoHS CCC IP65

配光曲线 Light Distribution Curve

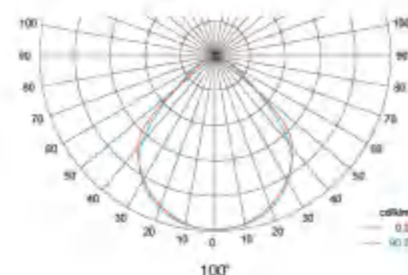

等照度图 Illumination Map

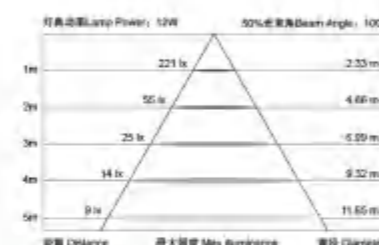

技术参数 Specification

类别	Product Code	参 数 Parameter
额定功率	Rated Power	12W
光源 / 数量	LED Quantity	LED / 48pcs
输入电压	Input Voltage	DC 24V
色温	Color Temperature	3000K / 4000K / 5700K
50%光束角	50% Beam Angle	100°
控制方式	Control Mode	ON-OFF
使用寿命	Life	>30000H
防护等级	Protection Grade	IP 65
工作环境温度	Temperature of Working Condition	-25°C-50°C
灯具净重	Net Weight	0.35kg
中包规格	Package Specification	50x40x1010mm
外箱规格 / 数量	Outside Box Specifications / Quantity	1040x280x230mm / 25pcs

颜色选择 Color Selection

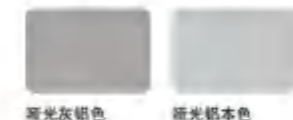

产品尺寸 Product Size

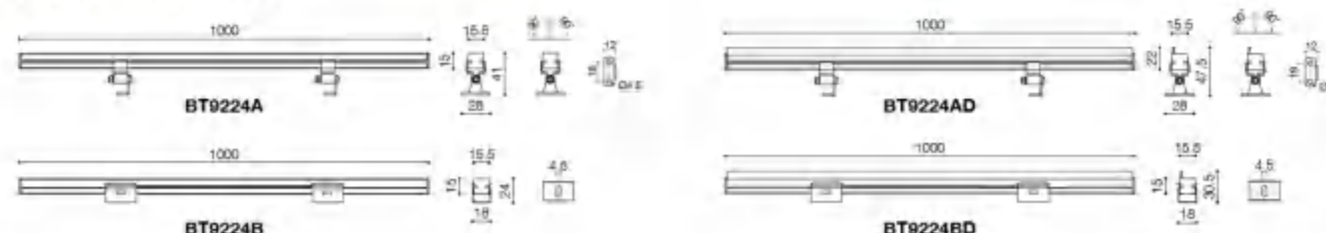

BT9234A Series

专利设计 DESIGN PATENT



BT9234AD



BT9234A



遮光板设计, 防止眩光。
Visor design to prevent glare.



装饰盖板设计, 提升美观度。
Decorative cover design to enhance the aesthetic.



防水公母插连接, 便于安装。
Waterproof female plug connection, easy to install.

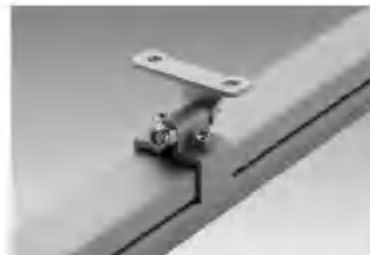

优质铝型材安装支架, 可调节照射角度。
Aluminium alloy mounting bracket.

适用场合

主要应用于楼宇、桥梁、河道等亮化工程。

The Application of Occasions

Suitable places: Buildings, Bridges, Rivers and Other lighting.

产品特点说明

1. 极简的工业设计造型, 美学与实用的完美结合, 外观和结构专利。
2. 灯体主体部分采用铝型材和高压压铸铝, 表面氧化处理, 防腐蚀、抗老化, 延长使用寿命。
3. 透光罩采用进口PC材质, 加装装饰盖板, 提升美观度。
4. 全灯防水采用结构性防水设计, 安装维护简便, 控制方式可多种选择: 单色、RGB内控、DMX512外控。
5. 采用整体灌胶处理, 有效保证了防护等级IP65。
6. 安装采用可调节安装支架, 安装简洁方便。

Product Description

1. Simple and practical design, Perfect aesthetic and practical union, patented appearance and structure technology.
2. High pressure Aluminium die-cast or alloy body, anodized surface, double anti-corrosion to expand the working life.
3. The transparent cover is made of imported PC material, and the decorative cover plate is added to enhance the aesthetic appearance.
4. Adopt structural waterproof design, simple installation and repair, Control Mode: Monochrome control; RGB inner control; DMX512 external control.
5. Whole pouring treatment to ensure the high level of IP rating (IP-65).
6. Adopt adjustable mounting bracket.

CE RoHS CCC IP65

配光曲线 Light Distribution Curve

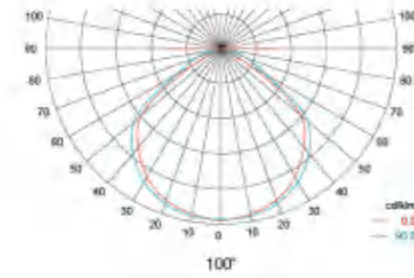

等照度图 Illumination Map

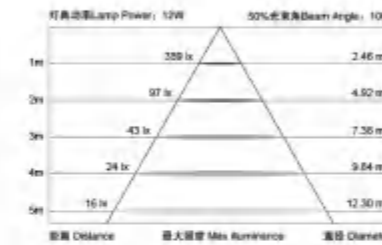

技术参数 Specification

类别	Product Code	参数 Parameter
额定功率	Rated Power	12W
光源 / 数量	LED Quantity	LED / 48pcs
输入电压	Input Voltage	DC 24V
色温	Color Temperature	3000K / 4000K / 5700K
50%光束角	50% Beam Angle	100°
控制方式	Control Mode	ON-OFF
使用寿命	Life	>30000H
防护等级	Protection Grade	IP 65
工作环境温度	Temperature of Working Condition	-25°C-50°C
灯具净重	Net Weight	0.6kg
中包规格	Package Specification	80x50x1010mm
外包装规格 / 数量	Outside Box Specifications / Quantity	1040x330x280mm / 25pcs

颜色选择 Color Selection

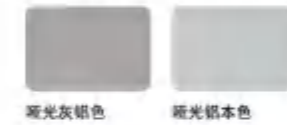

产品尺寸 Product Size

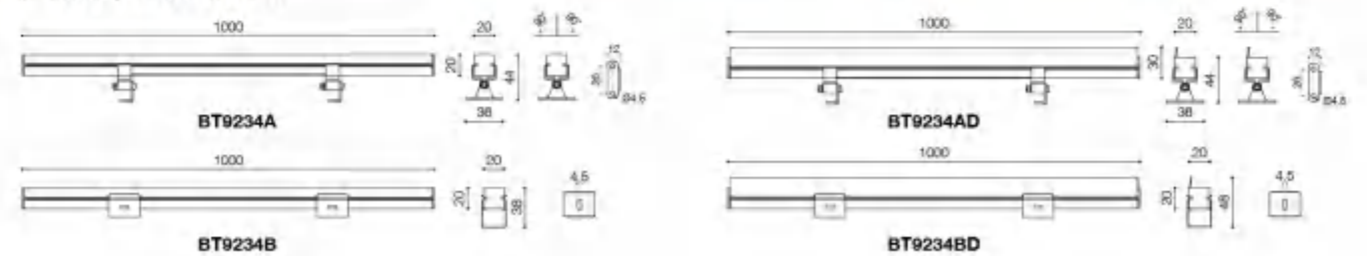

BT9244A Series

专利设计 DESIGN PATENT



BT9244AD



BT9244A



适用场合

主要应用于楼宇、桥梁、河道等亮化工程。

The Application of Occasions

Suitable places: Buildings, Bridges, Rivers and Other lighting.

产品特点说明

1. 极简的工业设计造型，美学与实用的完美结合，外观和结构专利。
2. 灯体主体部分采用铝型材和高压压铸铝，表面氧化处理，防腐蚀、抗老化，延长使用寿命。
3. 透光罩采用进口PC材质，加装装饰盖板，提升美观度。
4. 全灯防水采用结构性防水设计，安装维护简便，控制方式可多种选择：单色、RGB内控、DMX512外控。
5. 采用整体灌胶处理，有效保证了防护等级IP65。
6. 安装采用可调节安装支架，安装简洁方便。

Product Description

1. Simple and practical design, Perfect aesthetic and practical union, patented appearance and structure technology.
2. High pressure Aluminium die-cast or alloy body, anodized surface, double anti-corrosion to expand the working life.
3. The transparent cover is made of imported PC material, and the decorative cover plate is added to enhance the aesthetic appearance.
4. Adopt structural waterproof design, simple installation and repair, Control Mode: Monochrome control; RGB inner control; DMX512 external control.
5. Whole pouring treatment to ensure the high level of IP rating (IP-65).
6. Adopt adjustable mounting bracket.



遮光板设计，防止眩光。
Visor design to prevent glare.



装饰盖板设计，提升美观度。
Decorative cover design to enhance the aesthetic.



防水公母插连接，便于安装。
Waterproof female plug connection, easy to install.

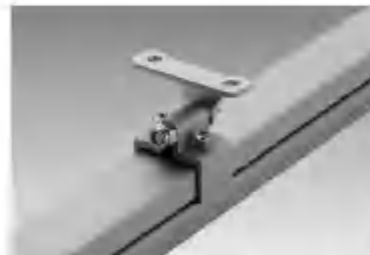

优质铝型材安装支架，可调节照射角度。
Aluminium alloy mounting bracket.

CE RoHS CCC IP65

配光曲线 Light Distribution Curve

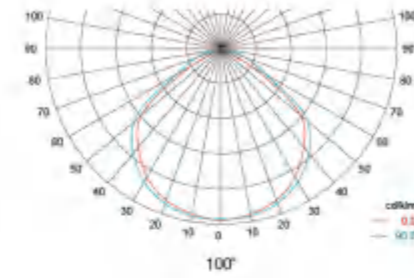

等照度图 Illumination Map

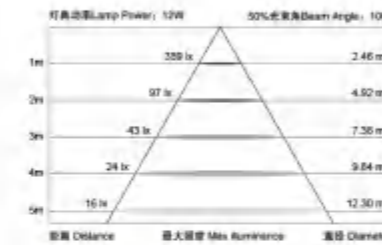

技术参数 Specification

类别	Product Code	参 数 Parameter
额定功率	Rated Power	12W
光源 / 数量	LED Quantity	LED / 48pcs
输入电压	Input Voltage	DC 24V
色温	Color Temperature	3000K / 4000K / 5700K / RGB
50%光束角	50% Beam Angle	100°
控制方式	Control Mode	ON-OFF / DMX512
使用寿命	Life	>30000H
防护等级	Protection Grade	IP 65
工作环境温度	Temperature of Working Condition	-25°C-50°C
灯具净重	Net Weight	0.6kg
中包规格	Package Specification	80x50x1010mm
外箱规格 / 数量	Outside Box Specifications / Quantity	1040x330x280mm / 25pcs

颜色选择 Color Selection

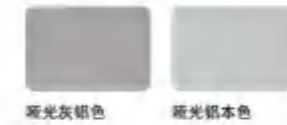

高光灰银色 高光铝本色



产品尺寸 Product Size

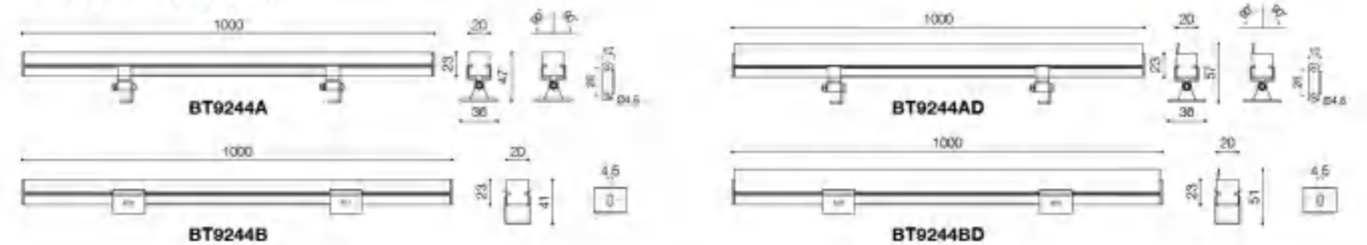

BT9227H1-LED48

专利号 Num: 201630151769.3



丝印超白钢化玻璃, 提升美观程度。
Silk-printing ultrawhite tempered glass.



防水公母插连接, 便于安装。
Waterproof female plug connection, easy to install.

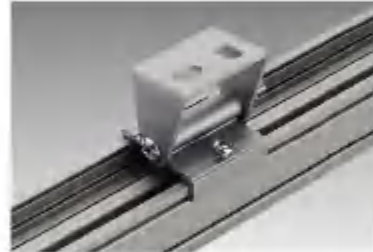

优质铝型材安装支架, 可调节照射角度。
Aluminium alloy mounting bracket.



注塑端盖, 优质硅胶密封。
Injection end cap with quality silicone rubber.

适用场合

主要应用于楼宇、桥梁、河道等亮化工程。

The Application of Occasions

Suitable places: Buildings, Bridges, Rivers and Other lighting.

产品特点说明

1. 极简的工业设计造型, 美学与实用的完美结合, 外观和结构专利。
2. 灯体主体部分采用铝型材和高压压铸铝, 表面氧化处理, 防腐蚀、抗老化, 延长使用寿命。
3. 透光罩采用丝印钢化玻璃, 提高了灯具整体的美观程度, 灵活的二次光学透镜配光, 根据实际需要多种光束角选择。
4. 采用高效率、高稳定性恒流驱动电源, 保证了光源的稳定工作, 降低光衰, 延长使用寿命。
5. 灯体表面设计了散热片更有利于通风, 增加散热面积, 迅速散热, 升华了灯具的整体美观程度。
6. 采用硅胶密封结构设计, 有效保证了防护等级IP65。
7. 安装采用可调节安装支架, 安装简洁方便。

Product Description

1. Simple and practical design, Perfect aesthetic and practical union, patented appearance and structure technology.
2. High pressure Aluminium die-cast or alloy body, anodized surface, double anti-corrosion to expand the working life.
3. Tempered glass diffuser, effectively improve the transmission rate of light. Multiple Beam-angle choice.
4. High efficiency constant current driver, ensure the light source is maximum used.
5. Heat sink design on the light body surface, increase the efficiency of heat-dissipation.
6. Using silicone rubber leakproof structure design to ensure the high level of IP rating (IP-65).
7. Adopt adjustable mounting bracket.

CE RoHS CCC IP65

配光曲线 Light Distribution Curve

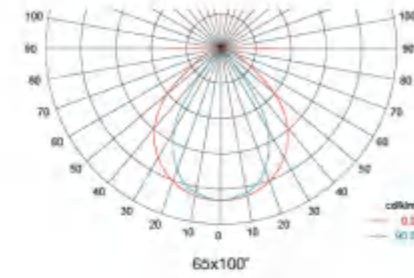

等照度图 Illumination Map

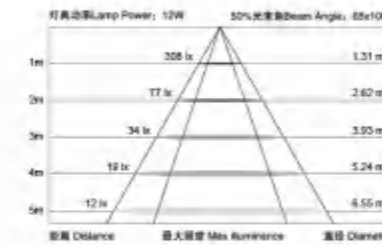

技术参数 Specification

类别	Product Code	参数 Parameter
额定功率	Rated Power	12W
光源 / 数量	LED Quantity	LED / 48pcs
输入电压	Input Voltage	DC 24V
色温	Color Temperature	3000K / 4000K / 5700K / RGB
50%光束角	50% Beam Angle	65°x100°
控制方式	Control Mode	ON-OFF / DMX512
使用寿命	Life	>30000H
防护等级	Protection Grade	IP 65
工作环境温度	Temperature of Working Condition	-25°C-50°C
灯具净重	Net Weight	1kg
中包规格	Package Specification	65x50x1010mm
外包装规格 / 数量	Outside Box Specifications / Quantity	1030x215x170mm / 9pcs

颜色选择 Color Selection

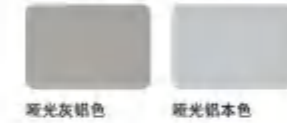

产品尺寸 Product Size

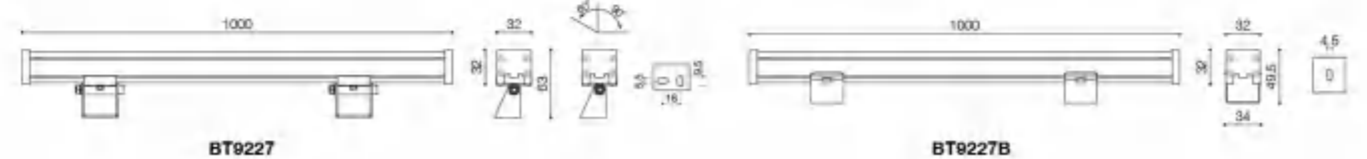

BT9233

专利设计 DESIGN PATENT



装饰盖板设计, 提升美观度。
Decorative cover design to enhance the aesthetic.



防水公母插连接, 便于安装。
Waterproof female plug connection, easy to install.



整体型材安装槽。
Integral profile mounting groove.



特殊卡扣式安装, 便于施工维护。
Special buckle type installation, easy maintenance.

适用场合

主要应用于楼宇、桥梁、河道等亮化工程。

The Application of Occasions

Suitable places: Buildings, Bridges, Rivers and Other lighting.

产品特点说明

1. 极简的工业设计造型, 美学与实用的完美结合, 外观和结构专利。
2. 灯体主体部分采用铝型材和高压压铸铝, 表面氧化处理, 防腐蚀、抗老化, 延长使用寿命。
3. 透光罩采用进口PC材质, 加装装饰盖板, 提升美观度。
4. 全灯防水采用结构性防水设计, 安装维护简便, 控制方式可多种选择: 单色、RGB内控、DMX512外控。
5. 采用整体灌胶处理, 有效保证了防护等级IP65。
6. 特殊卡扣式安装, 便于施工维护。

Product Description

1. Simple and practical design, Perfect aesthetic and practical union, patented appearance and structure technology.
2. High pressure Aluminium die-cast or alloy body, anodized surface, double anti-corrosion to expand the working life.
3. The transparent cover is made of imported PC material, and the decorative cover plate is added to enhance the aesthetic appearance.
4. Adopt structural waterproof design, simple installation and repair, Control Mode: Monochrome control; RGB inner control; DMX512 external control.
5. Whole pouring treatment to ensure the high level of IP rating (IP-65).
6. Special buckle type installation, easy maintenance.

CE RoHS CCC IP65

配光曲线 Light Distribution Curve

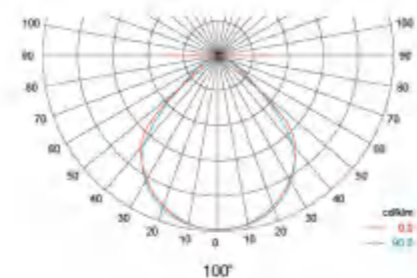

等照度图 Illumination Map

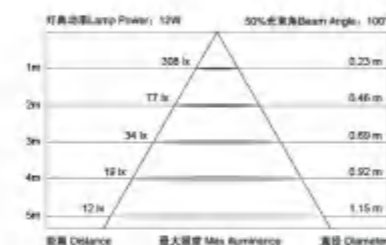

技术参数 Specification

类别	Product Code	参 数 Parameter
额定功率	Rated Power	12W
光源 / 数量	LED Quantity	LED / 48pcs
输入电压	Input Voltage	DC 24V
色温	Color Temperature	3000K / 4000K / 5700K / RGB
50%光束角	50% Beam Angle	100°
控制方式	Control Mode	ON-OFF / DMX512
使用寿命	Life	>30000H
防护等级	Protection Grade	IP 65
工作环境温度	Temperature of Working Condition	-25°C~50°C
灯具净重	Net Weight	3.3kg
中包规格	Package Specification	110x105x1010mm
外箱规格 / 数量	Outside Box Specifications / Quantity	1030x250x250mm / 4pcs

颜色选择 Color Selection

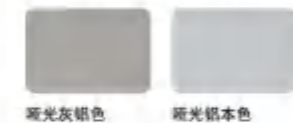

产品尺寸 Product Size



BT9225A

专利设计 DESIGN PATENT



进口扩散PC罩，出光均匀。
Import diffusion PC cover, out of uniform.



线槽设计，便于施工。
Groove design, convenient for construction.



防水公母插连接，便于安装。
Waterproof female plug connection, easy to install.



弹簧卡支架，便于安装。
Spring card holder for easy installation.

适用场合

主要应用于楼宇、桥梁、河道等亮化工程。

The Application of Occasions

Suitable places: Buildings, Bridges, Rivers and Other lighting.

产品特点说明

1. 主体采用优质铝合金型材，表面氧化处理，颜色可多种选择。
2. 透光采用乳白扩散PC材质，高透光率，出光均匀柔和。
3. 弹簧卡扣式安装支架，便捷施工安装及维修。
4. 适用于河道、建筑、桥梁等亮化工程。
5. 采用硅橡胶密封结构设计，有效保证了防护等级IP65。
6. 安装采用可调节安装支架，安装简洁方便。

Product Description

1. Aluminium alloy body, anodized surface, color customized.
2. Opal PC diffuser, high transmission rate and light tender.
3. Spring snap-on mount bracket, easy installing and repairing.
4. Suitable place: Riverway, building, bridge, etc.
5. Using silicone rubber leakproof structure design to ensure the high level of IP rating (IP:65).
6. Adopt adjustable mounting bracket.

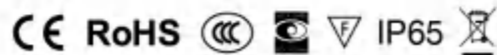

配光曲线 Light Distribution Curve

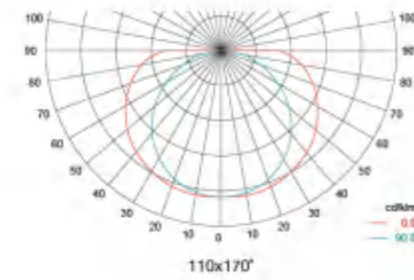

等照度图 Illumination Map

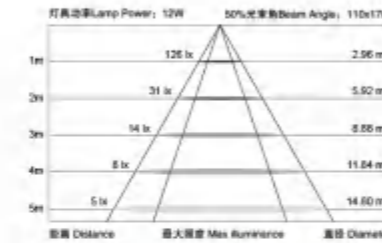

技术参数 Specification

类别	Product Code	参数 Parameter
额定功率	Rated Power	12W
光源 / 数量	LED Quantity	LED / 48pcs
输入电压	Input Voltage	DC 24V
色温	Color Temperature	3000K / 4000K / 5700K / RGB
50%光束角	50% Beam Angle	110°x170°
控制方式	Control Mode	ON-OFF / DMX512
使用寿命	Life	>30000H
防护等级	Protection Grade	IP 65
工作环境温度	Temperature of Working Condition	-25°C-50°C
灯具净重	Net Weight	1kg
中包规格	Package Specification	55x90x1015mm
外箱规格 / 数量	Outside Box Specifications / Quantity	1035x470x245mm / 20pcs



颜色选择 Color Selection

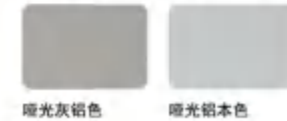

产品尺寸 Product Size



BT9229A

专利号 Num: 201630151784.8



进口扩散PC罩，出光均匀。
Import diffusion PC cover, out of uniform.

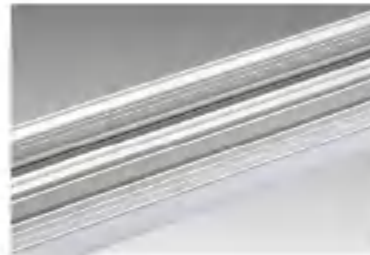

线槽设计，便于施工。
Groove design, convenient for construction.



防水公母插连接，便于安装。
Waterproof female plug connection, easy to install.



弹簧卡支架，便于安装。
Spring card holder for easy installation.

适用场合

主要应用于楼宇、桥梁、河道等亮化工程。

The Application of Occasions

Suitable places: Buildings, Bridges, Rivers and Other lighting.

产品特点说明

1. 主体采用优质铝合金型材，表面氧化处理，颜色可多种选择。
2. 透光采用乳白扩散PC材质，高透光率，出光均匀柔和。
3. 弹簧卡扣式安装支架，便捷施工安装及维修。
4. 适用于河道、建筑、桥梁等亮化工程。
5. 采用硅橡胶密封结构设计，有效保证了防护等级IP65。
6. 安装采用可调节安装支架，安装简洁方便。

Product Description

1. Aluminium alloy body, anodized surface, color customized.
2. Opal PC diffuser, high transmission rate and light tender.
3. Spring snap-on mount bracket, easy installing and repairing.
4. Suitable place: Riverway, building, bridge, etc.
5. Using silicone rubber leakproof structure design to ensure the high level of IP rating (IP:65).
6. Adopt adjustable mounting bracket.



配光曲线 Light Distribution Curve

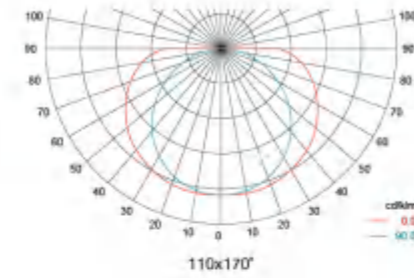

等照度图 Illumination Map

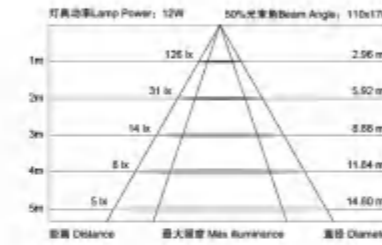

技术参数 Specification

类别	Product Code	参数 Parameter
额定功率	Rated Power	12W
光源 / 数量	LED Quantity	LED / 48pcs
输入电压	Input Voltage	DC 24V
色温	Color Temperature	3000K / 4000K / 5700K / RGB
50%光束角	50% Beam Angle	110°x170°
控制方式	Control Mode	ON-OFF / DMX512
使用寿命	Life	>30000H
防护等级	Protection Grade	IP 65
工作环境温度	Temperature of Working Condition	-25°C-50°C
灯具净重	Net Weight	0.6kg
中包规格	Package Specification	40x80x1015mm
外箱规格 / 数量	Outside Box Specifications / Quantity	1035x420x270mm / 30pcs



颜色选择 Color Selection

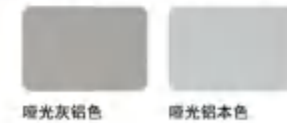

产品尺寸 Product Size



F0084

专利号 Num: 201630151809.4



适用场合

主要应用于草坪、花园、公园等场所，或用于照射建筑物。

The Application of Occasions

Suitable places: Lawn, Garden or to be used to light the buildings.

产品特点说明

1. 极简的工业设计造型，美学与实用的完美结合，外观和结构专利。
2. 灯体整体采用高压压铸铝，表面双层静电喷塑处理，防腐性、抗老化，保证8年以上的使用寿命。
3. 透光罩采用丝印钢化玻璃，提高了灯具整体的美观程度，灵活的二次光学透镜配光，根据实际需要多种光束角选择。
4. 灯体散热部分采用实心压铸铝加强散热，降低光源的衰减程度。灯体原装支架相对旋转设计，可根据实际需求调节照射方向。
5. 采用硅橡胶密封结构设计，有效保证了防护等级IP65。
6. 安装采用高压压铸铝支架，使得安装方便牢固。

Product Description

1. Simple and practical design, Perfect aesthetic and practical union, patented appearance and structure technology.
2. High pressure Aluminium die-cast housing, coated with outdoor used powder, double anti-corrosion to ensure 8 year long-life span.
3. Tempered glass diffuser, effectively improve the transmission rate of light. Multiple Beam-angle choice.
4. Aluminium die-cast heat sink part, increase the efficiency of heat-dissipation. Rotatable bracket design, adjust the light angle accordingly.
5. Using silicone rubber leakproof structure design to ensure the high level of IP rating (IP:65).
6. Installed with high pressure aluminium die-cast bracket, simple installation.



旋转支架设计，可调角度。
Rotary support design, adjustable angle.



定制防水接头，提高性能和美观度。
Custom waterproof joints to improve performance and beauty.



配光曲线 Light Distribution Curve

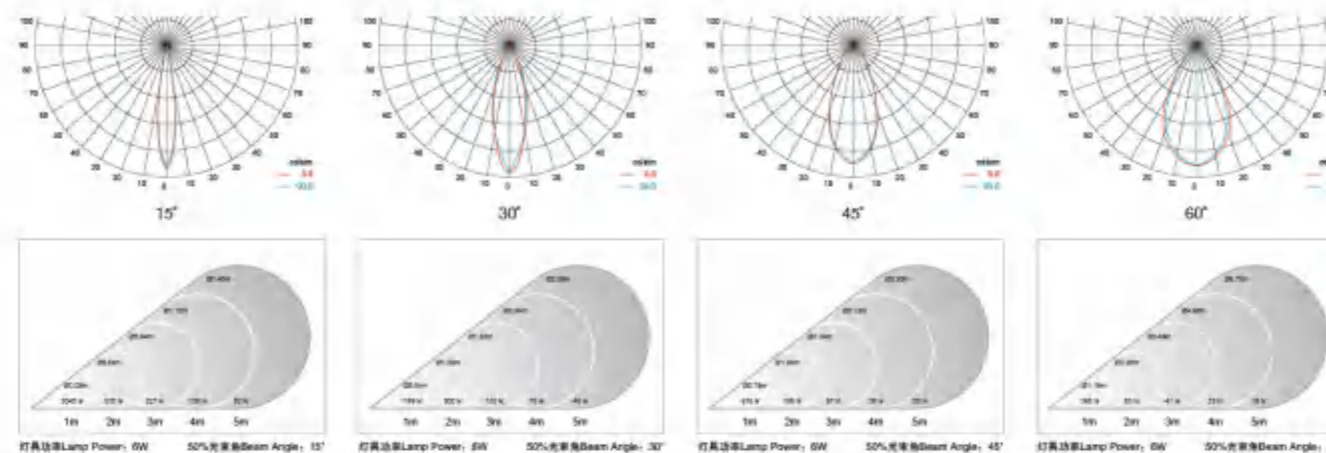

技术参数 Specification

类别	参数	类别	参数	类别	参数
额定功率 Rated Power	6W	光源 / 数量 LED Quantity	LED / 3pcs	输入电压 Input Voltage	DC 24V / AC 220V
色温 Color Temperature	3000K / 4000K / 5700K	50%光束角 50% Beam Angle	15° 30° 45° 60°	控制方式 Control Mode	ON-OFF
使用寿命 Life	>30000H	防护等级 Protection Grade	IP 65	工作环境温度 Temperature of Working Condition	-25°C-50°C
灯具净重 Net Weight	0.36kg	中包规格 Package Specification	120x120x90mm	外箱规格 / 数量 Outside Box Specifications / Quantity	620x620x200mm / 50pcs



颜色选择 Color Selection

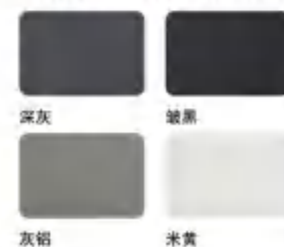

产品尺寸 Product Size

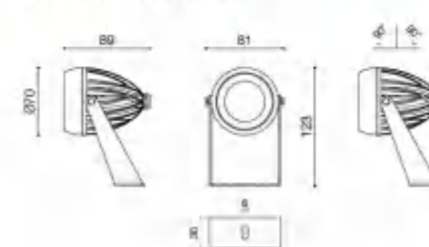

F0086

专利设计 DESIGN PATENT



适用场合

主要应用于草坪、花园、公园等场所，或用于照射建筑物。

The Application of Occasions

Suitable places: Lawn, Garden or to be used to light the buildings.

产品特点说明

1. 极简的工业设计造型，美学与实用的完美结合，外观和结构专利。
2. 灯体整体采用高压压铸铝，表面双层静电喷塑处理，防腐性、抗老化，保证8年以上的使用寿命。
3. 透光罩采用丝印钢化玻璃，提高了灯具整体的美观程度，灵活的二次光学透镜配光，根据实际需要多种光束角选择。
4. 灯体散热部分采用实心压铸铝加强散热，降低光源的衰减程度。灯体原装支架相对旋转设计，可根据实际需求调节照射方向。
5. 采用硅橡胶密封结构设计，有效保证了防护等级IP65。
6. 安装采用高压压铸铝支架，使得安装方便牢固。

Product Description

1. Simple and practical design, Perfect aesthetic and practical union, patented appearance and structure technology.
2. High pressure Aluminium die-cast housing, coated with outdoor used powder, double anti-corrosion to ensure 8 year long-life span.
3. Tempered glass diffuser, effectively improve the transmission rate of light. Multiple Beam-angle choice.
4. Aluminium die-cast heat sink part, increase the efficiency of heat-dissipation. Rotatable bracket design, adjust the light angle accordingly.
5. Using silicone rubber leakproof structure design to ensure the high level of IP rating (IP:65).
6. Installed with high pressure aluminium die-cast bracket, simple installation.



旋转支架设计，可调角度。
Rotary support design, adjustable angle.



定制防水接头，提高性能和美观度。
Custom waterproof joints to improve performance and beauty.



配光曲线 Light Distribution Curve

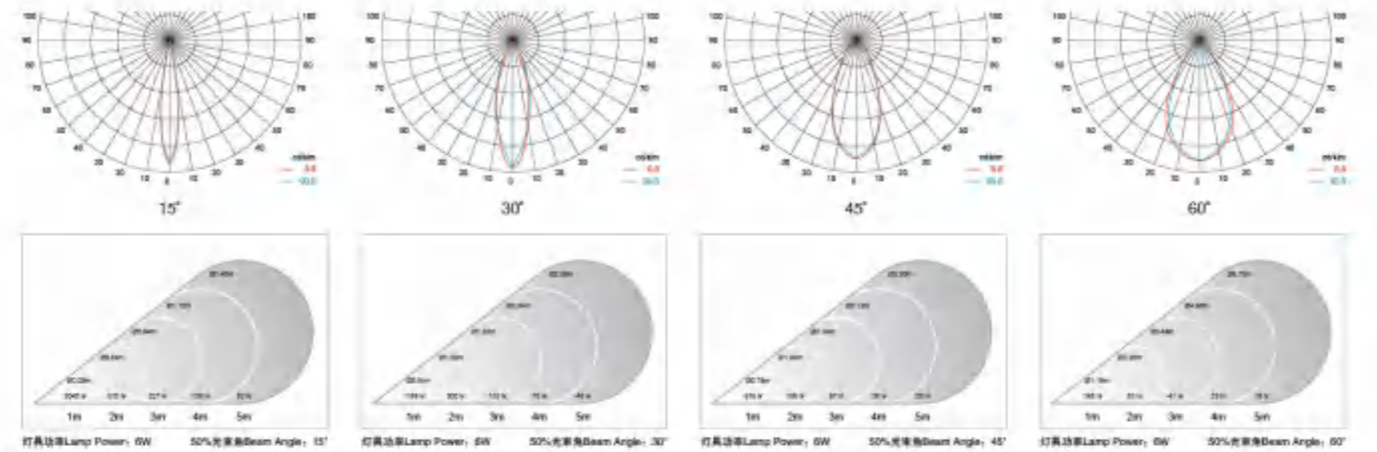

技术参数 Specification

类别	参数	类别	参数	类别	参数
额定功率 Rated Power	6W	光源 / 数量 LED Quantity	LED / 3pcs	输入电压 Input Voltage	DC 24V
色温 Color Temperature	3000K / 4000K / 5700K	50%光束角 50% Beam Angle	15° 30° 45° 60°	控制方式 Control Mode	ON-OFF
使用寿命 Life	>30000H	防护等级 Protection Grade	IP 65	工作环境温度 Temperature of Working Condition	-25°C~50°C
灯具净重 Net Weight	0.3kg	中包规格 Package Specification	120x120x90mm	外箱规格 / 数量 Outside Box Specifications / Quantity	620x620x200mm / 50pcs



颜色选择 Color Selection

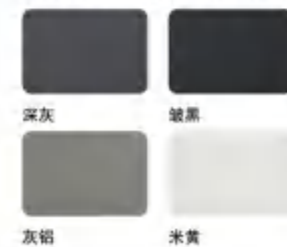

产品尺寸 Product Size

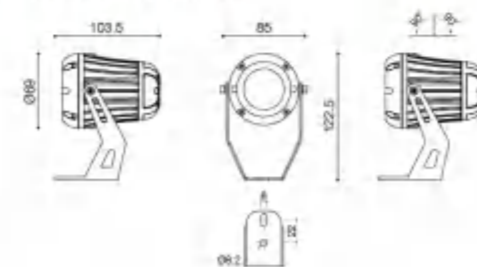

F0073A 小水滴

专利号 Num: 201230619027.0



适用场合

主要应用于草坪、花园、公园等场所，或用于照射建筑物。

The Application of Occasions

Suitable places: Lawn, Garden or to be used to light the buildings.

产品特点说明

1. 极简的工业设计造型，美学与实用的完美结合，外观和结构专利。
2. 灯体整体采用高压压铸铝，表面双层静电喷塑处理，防腐蚀、抗老化，保证8年以上的使用寿命。
3. 透光罩采用丝印钢化玻璃，提高了灯具整体的美观程度，灵活的二次光学透镜配光，根据实际需要多种光束角选择。
4. 灯体散热部分采用实心压铸铝加强散热，降低光源的衰减程度。灯体原装支架相对旋转设计，可根据实际需求调节照射方向。
5. 采用硅橡胶密封结构设计，有效保证了防护等级IP65。
6. 安装采用高压压铸铝支架，使得安装方便牢固。

Product Description

1. Simple and practical design, Perfect aesthetic and practical union, patented appearance and structure technology.
2. High pressure Aluminium die-cast housing, coated with outdoor used powder, double anti-corrosion to ensure 8 year long-life span.
3. Tempered glass diffuser, effectively improve the transmission rate of light. Multiple Beam-angle choice.
4. Aluminium die-cast heat sink part, increase the efficiency of heat-dissipation. Rotatable bracket design, adjust the light angle accordingly.
5. Using silicone rubber leakproof structure design to ensure the high level of IP rating (IP:65).
6. Installed with high pressure aluminium die-cast bracket, simple installation.

CE RoHS CCC IP65

F0073B 小水滴

专利号 Num: 201230619114.6



卡扣式安装支架。
Buckle type mounting bracket.



平地式安装支架。
Flat mounting bracket.

配光曲线 Light Distribution Curve

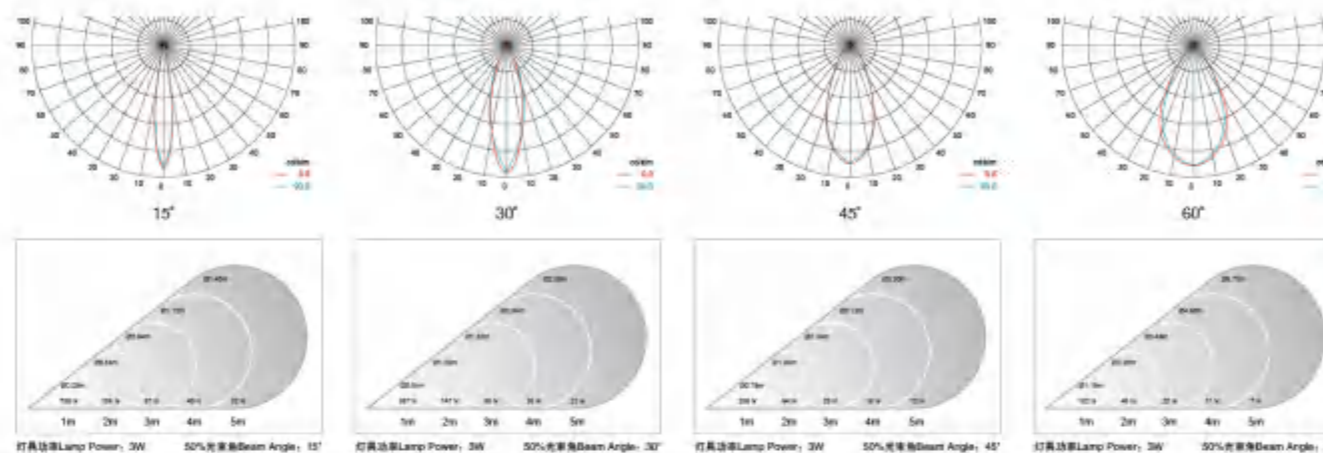

技术参数 Specification

类别 Category	参数 Parameter	类别 Category	参数 Parameter	类别 Category	参数 Parameter
额定功率 Rated Power	3W	光源 / 数量 LED Quantity	LED / 1pcs	输入电压 Input Voltage	DC 24V / AC 220V
色温 Color Temperature	3000K / 4000K / 5700K	50%光束角 50% Beam Angle	15° 30° 45° 60°	控制方式 Control Mode	ON-OFF
使用寿命 Life	>30000H	防护等级 Protection Grade	IP 65	工作环境温度 Temperature of Working Condition	-25°C-50°C
灯具净重 Net Weight	0.4kg	中包规格 Package Specification	120x120x70mm	外箱规格 / 数量 Outside Box Specifications / Quantity	380x260x310mm / 24pcs



颜色选择 Color Selection

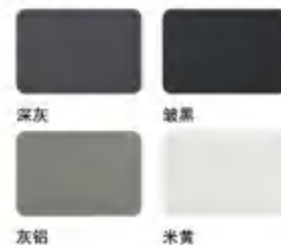

产品尺寸 Product Size

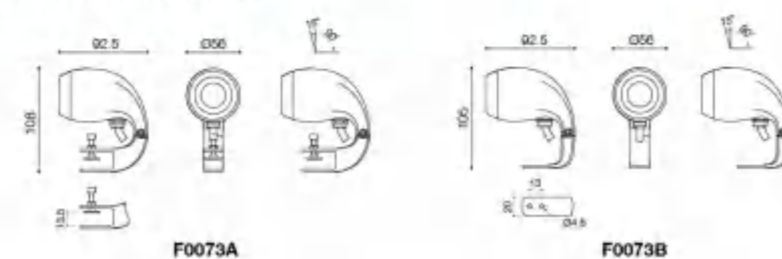

F0074A 大水滴

专利号 Num: 201230619027.0

F0074B 大水滴

专利号 Num: 201230619114.6



适用场合

主要应用于草坪、花园、公园等场所，或用于照射建筑物。

The Application of Occasions

Suitable places: Lawn, Garden or to be used to light the buildings.

产品特点说明

1. 极简的工业设计造型，美学与实用的完美结合，外观和结构专利。
2. 灯体整体采用高压压铸铝，表面双层静电喷塑处理，防腐蚀、抗老化，保证8年以上的使用寿命。
3. 透光罩采用丝印钢化玻璃，提高了灯具整体的美观程度，灵活的二次光学透镜配光，根据实际需要多种光束角选择。
4. 灯体散热部分采用实心压铸铝加强散热，降低光源的衰减程度。灯体原装支架相对旋转设计，可根据实际需求调节照射方向。
5. 采用硅橡胶密封结构设计，有效保证了防护等级IP65。
6. 安装采用高压压铸铝支架，使得安装方便牢固。

Product Description

1. Simple and practical design, Perfect aesthetic and practical union, patented appearance and structure technology.
2. High pressure Aluminium die-cast housing, coated with outdoor used powder, double anti-corrosion to ensure 8 year long-life span.
3. Tempered glass diffuser, effectively improve the transmission rate of light. Multiple Beam-angle choice.
4. Aluminium die-cast heat sink part, increase the efficiency of heat-dissipation. Rotatable bracket design, adjust the light angle accordingly.
5. Using silicone rubber leakproof structure design to ensure the high level of IP rating (IP:65).
6. Installed with high pressure aluminium die-cast bracket, simple installation.



卡扣式安装支架。
Buckle type mounting bracket.



平地式安装支架。
Flat mounting bracket.

CE RoHS CCC IP65

配光曲线 Light Distribution Curve

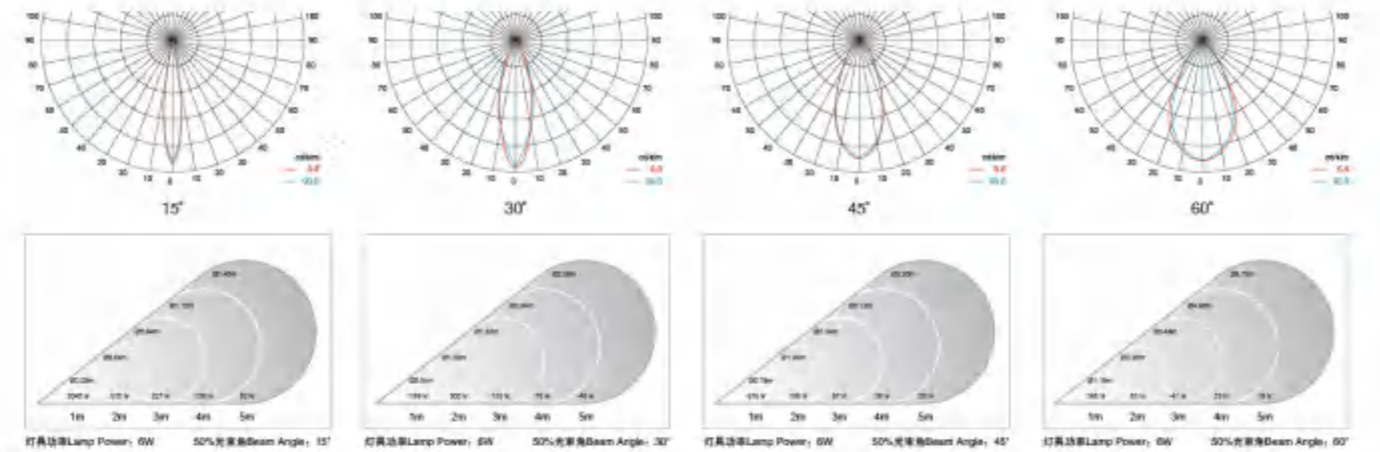

技术参数 Specification

类别	参数	类别	参数	类别	参数
额定功率 Rated Power	6W	光源 / 数量 LED Quantity	LED / 3pcs	输入电压 Input Voltage	DC 24V / AC 220V
色温 Color Temperature	3000K / 4000K / 5700K	50%光束角 50% Beam Angle	15° 30° 45° 60°	控制方式 Control Mode	ON-OFF
使用寿命 Life	>30000H	防护等级 Protection Grade	IP 65	工作环境温度 Temperature of Working Condition	-25°C~50°C
灯具净重 Net Weight	1kg	中包规格 Package Specification	150x150x90mm	外箱规格 / 数量 Outside Box Specifications / Quantity	320x320x300mm / 12pcs



颜色选择 Color Selection

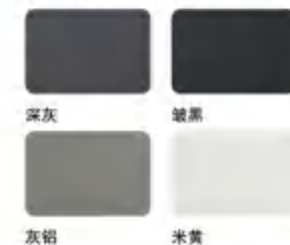

产品尺寸 Product Size

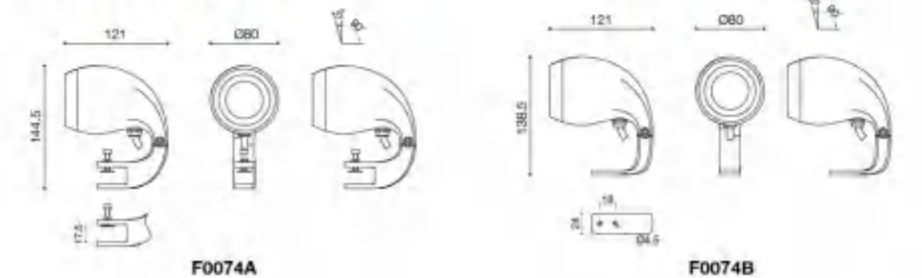

BT9235H0.12

专利号 Num: 201630151768.9



BT9235DH0.12-LED2



BT9235H0.12-LED2



丝印超白钢化玻璃, 提升美观程度。
Silk-printing ultrawhite tempered glass.



专利性结构型防水, 提升卖点和档次。
Patented water-proof construction.



优质铝型材安装支架, 可调节照射角度。
Aluminium alloy mounting bracket.



压铸端盖, 优质硅胶密封。
Aluminium die-cast end cap with quality silicone rubber.

适用场合

主要应用于草坪、花园、公园等场所, 或用于照射建筑物。

The Application of Occasions

Suitable places: Lawn, Garden or to be used to light the buildings.

产品特点说明

1. 极简的工业设计造型, 美学与实用的完美结合, 外观和结构专利。
2. 灯体主体部分采用铝型材和高压压铸铝, 表面氧化处理, 防腐蚀、抗老化, 延长使用寿命。
3. 透光罩采用丝印钢化玻璃, 提高了灯具整体的美观程度, 灵活的二次光学透镜配光, 根据实际需要多种光束角选择。
4. 采用高效率、高稳定性恒流驱动电源, 保证了光源的稳定工作, 降低光衰, 延长使用寿命。
5. 灯体表面设计了散热片更有利于通风, 增加散热面积, 迅速散热, 升华了灯具的整体美观程度。
6. 全灯防水采用结构性防水设计, 安装维护简便, 控制方式可多种选择: 单色、RGB内控、DMX512外控。
7. 采用硅胶密封结构设计, 有效保证了防护等级IP65。
8. 安装采用可调节安装支架, 安装简洁方便。

Product Description

1. Simple and practical design, Perfect aesthetic and practical union, patented appearance and structure technology.
2. High pressure Aluminium die-cast or alloy body, anodized surface, double anti-corrosion to expand the working life.
3. Tempered glass diffuser, effectively improve the transmission rate of light. Multiple Beam-angle choice.
4. High efficiency constant current driver, ensure the light source is maximum used.
5. Heat sink design on the light body surface, increase the efficiency of heat-dissipation.
6. Adopt structural waterproof design, simple installation and repair, Control Mode: Monochrome control; RGB inner control; DMX512 external control.
7. Using silicone rubber leakproof structure design to ensure the high level of IP rating (IP65).
8. Adopt adjustable mounting bracket.



配光曲线 Light Distribution Curve

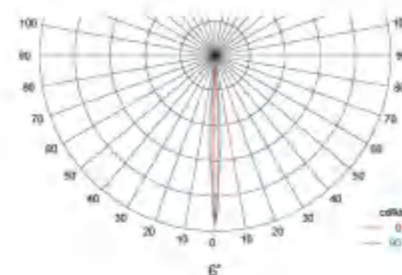

等照度图 Illumination Map

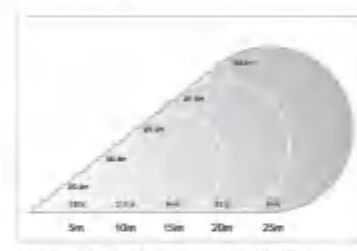

灯具功率(Lamp Power): 6W 50%光束角(Beam Angle): 6°

技术参数 Specification

类别	Product Code	参数 Parameter
额定功率	Rated Power	6W
光源 / 数量	LED Quantity	LED / 2pcs
输入电压	Input Voltage	DC 24V / AC 220V
色温	Color Temperature	3000K / 4000K / 5700K
50%光束角	50% Beam Angle	6°
控制方式	Control Mode	ON-OFF
使用寿命	Life	>30000H
防护等级	Protection Grade	IP 65
工作环境温度	Temperature of Working Condition	-25°C-50°C
灯具净重	Net Weight	0.6kg
中包规格	Package Specification	120x75x130mm
外箱规格 / 数量	Outside Box Specifications / Quantity	380x320x280mm / 24pcs

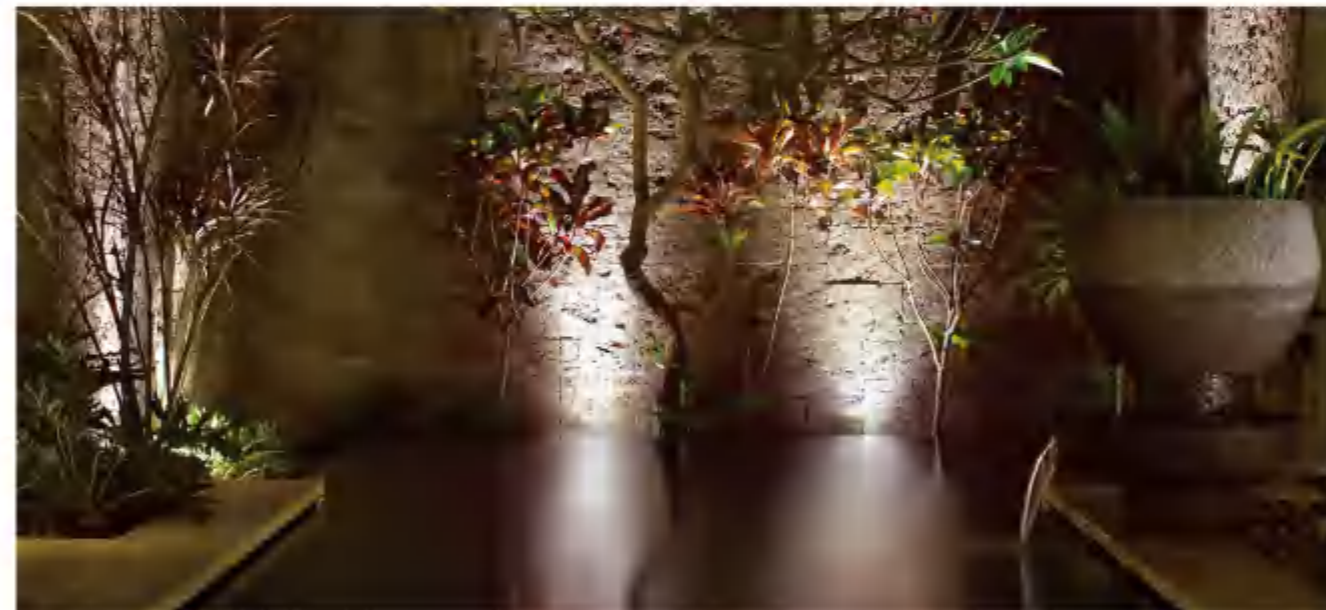

颜色选择 Color Selection

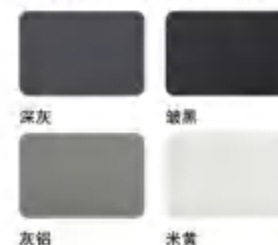

产品尺寸 Product Size

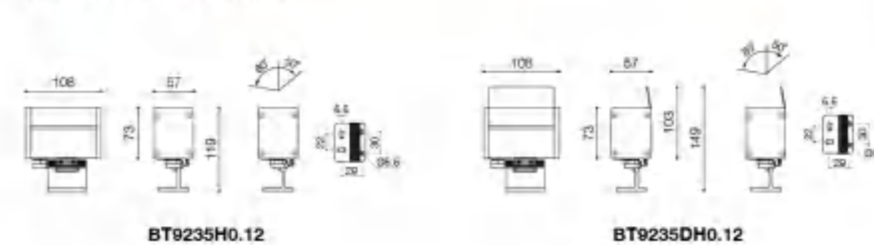

F0068

专利号 Num: 201230154196.1



敞开式散热片, 提高散热效果。
Open-type heat sink, improve heat dissipation efficiency.



RGB DMX512控制, 实现多种变化模式。
RGB DMX512 control, Various control mode combination.



独立的电源腔体, 优质硅胶密封。
Independent power supply housing with high quality silicone rubber sealing.



钣金可旋转安装支架。
Metal plate rotatable mounting bracket.

适用场合

主要应用于草坪、花园、公园等场所, 或用于照射建筑物。

The Application of Occasions

Suitable places: Lawn, Garden or to be used to light the buildings.

产品特点说明

1. 极简的工业设计造型, 美学与实用的完美结合, 外观和结构专利。
2. 灯体主体部分采用高压压铸铝, 表面双层静电喷塑处理, 防腐性、抗老化, 延长使用寿命。
3. 透光罩采用丝印钢化玻璃, 提高了灯具整体的美观程度, 灵活的二次光学透镜配光, 根据实际需要多种光束角选择。
4. 采用高效率、高稳定性恒流驱动电源, 保证了光源的稳定工作, 降低光衰, 延长使用寿命。
5. 独立的电源腔体设计, 有效的保证了电源的散热, 延长电源使用寿命, 控制方式可多种选择: 单色、RGB内控、DMX512外控。
6. 采用硅胶密封结构设计, 有效保证了防护等级IP65。
7. 可旋转安装支架设计, 根据实际应用调节角度, 使得应用发挥到最佳状态, 并且整灯安装简便。

Product Description

1. Simple and practical design, Perfect aesthetic and practical union, patented appearance and structure technology.
2. High pressure Aluminium die-cast body, double anti-corrosion to expand the working life.
3. Tempered glass diffuser, effectively improve the transmission rate of light. Multiple Beam-angle choice.
4. High efficiency constant current driver, ensure the light source is maximum used.
5. Independent power supply recessed design, extend the power supply working life, Control Mode: Monochrome control; RGB inner control; DMX512 external control.
6. Using silicone rubber leakproof structure design to ensure the high level of IP rating (IP:65).
7. Rotatable mounting bracket design to achieve the best light efficiency.

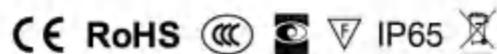

配光曲线 Light Distribution Curve

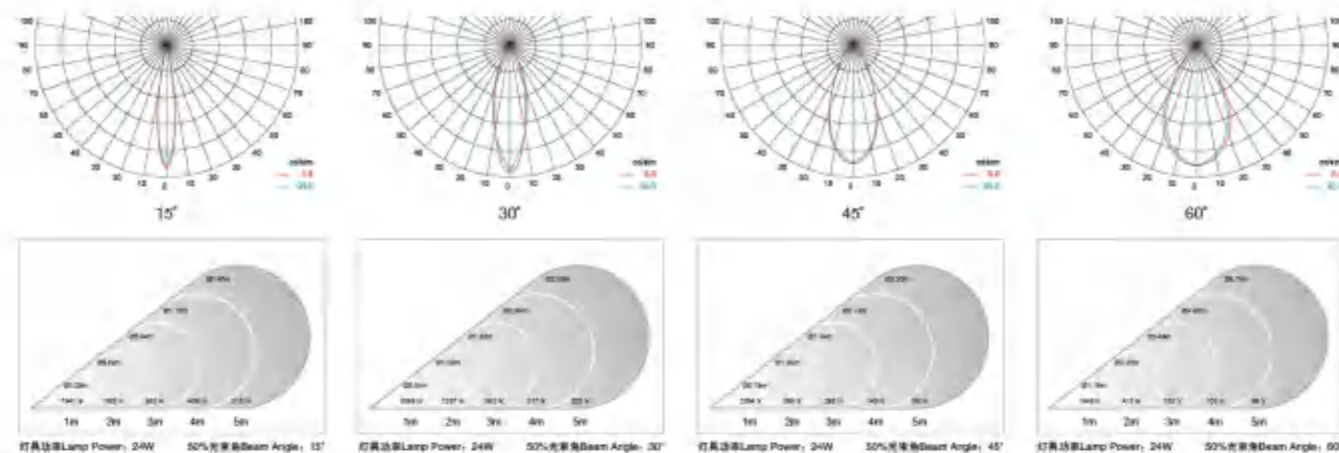

技术参数 Specification

名称	参数	类别	参数	类别	参数
额定功率 Rated Power	24W	光源 / 数量 LED Quantity	LED / 24pcs	输入电压 Input Voltage	DC 24V / AC 220V
色温 Color Temperature	3000K / 4000K / 5700K / RGB	50%光束角 50% Beam Angle	15° 30° 45° 60°	控制方式 Control Mode	ON-OFF / DMX512
使用寿命 Life	>30000H	防护等级 Protection Grade	IP 65	工作环境温度 Temperature of Working Condition	-25°C~50°C
灯具净重 Net Weight	2.3kg	中包规格 Package Specification	240x230x90mm	外箱规格 / 数量 Outside Box Specifications / Quantity	500x480x200mm / 8pcs



颜色选择 Color Selection

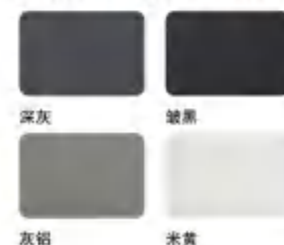

产品尺寸 Product Size

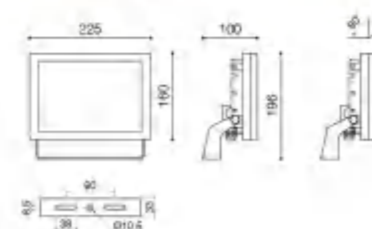

F0069

专利号 Num: 201230618788.4



敞开式散热片, 提高散热效果。
Open-type heat sink, improve heat dissipation efficiency.



RGB DMX512控制, 实现多种变化模式。
RGB DMX512 control, Various control mode combination.



独立的电源腔体, 优质硅胶密封。
Independent power supply housing with high quality silicone rubber sealing.



钣金可旋转安装支架。
Metal plate rotatable mounting bracket.

适用场合

主要应用于草坪、花园、公园等场所, 或用于照射建筑物。

The Application of Occasions

Suitable places: Lawn, Garden, or to be used to light the buildings.

产品特点说明

1. 极简的工业设计造型, 美学与实用的完美结合, 外观和结构专利。
2. 灯体主体部分采用高压压铸铝, 表面双层静电喷涂处理, 防腐性、抗老化, 延长使用寿命。
3. 透光罩采用丝印钢化玻璃, 提高了灯具整体的美观程度, 灵活的二次光学透镜配光, 根据实际需要多种光束角选择。
4. 采用高效率、高稳定性恒流驱动电源, 保证了光源的稳定工作, 降低光衰, 延长使用寿命。
5. 独立的电源腔体设计, 有效的保证了电源的散热, 延长电源使用寿命, 控制方式可多种选择: 单色、RGB 内控、DMX512外控。
6. 采用硅胶橡胶密封结构设计, 有效保证了防护等级IP65。
7. 可旋转安装支架设计, 根据实际应用调节角度, 使得应用发挥到最佳状态, 并且整灯安装简便。

Product Description

1. Simple and practical design, Perfect aesthetic and practical union, patented appearance and structure technology.
2. High pressure Aluminium die-cast body, double anti-corrosion to expand the working life.
3. Tempered glass diffuser, effectively improve the transmission rate of light. Multiple Beam-angle choice.
4. High efficiency constant current driver, ensure the light source is maximum used.
5. Independent power supply recessed design, extend the power supply working life, Control Mode: Monochrome control; RGB inner control; DMX512 external control.
6. Using silicone rubber leakproof structure design to ensure the high level of IP rating (IP:65).
7. Rotatable mounting bracket design to achieve the best light efficiency.



配光曲线 Light Distribution Curve

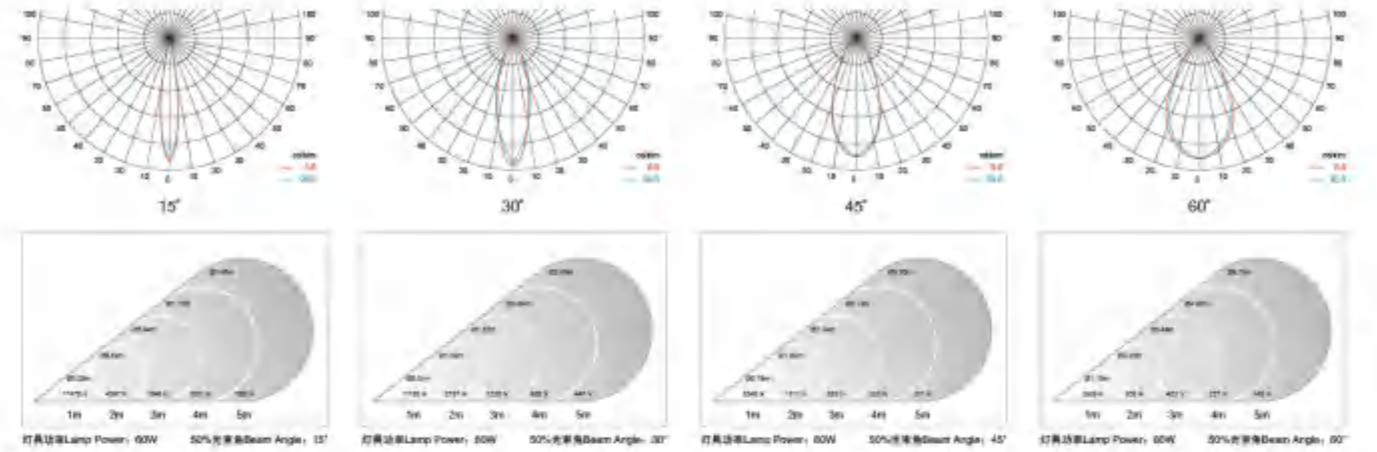

技术参数 Specification

参数	数值	参数	数值	参数	数值
额定功率 Rated Power	60W	光源 / 数量 LED Quantity	LED / 48pcs	输入电压 Input Voltage	DC 24V / AC 220V
色温 Color Temperature	3000K / 4000K / 5700K / RGB	50%光束角 50% Beam Angle	15° 30° 45° 60°	控制方式 Control Mode	ON-OFF / DMX512
使用寿命 Life	>30000H	防护等级 Protection Grade	IP 65	工作环境温度 Temperature of Working Condition	-25°C~50°C
灯具净重 Net Weight	4.5kg	中包规格 Package Specification	320x320x100mm	外箱规格 / 数量 Outside Box Specifications / Quantity	350x350x430mm / 4pcs



颜色选择 Color Selection

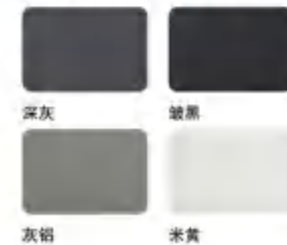

产品尺寸 Product Size

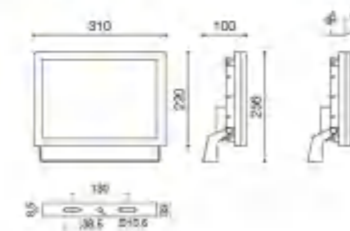

F0070

专利号 Num: 201230618849.7



敞开式散热片, 提高散热效果。
Open-type heat sink, improve heat dissipation efficiency.



RGB DMX512控制, 实现多种变化模式。
RGB DMX512 control, Various control mode combination.



独立的电源腔体, 优质硅胶密封。
Independent power supply housing with high quality silicone rubber sealing.



钣金可旋转安装支架。
Metal plate rotatable mounting bracket.

适用场合

主要应用于草坪、花园、公园等场所, 或用于照射建筑物。

The Application of Occasions

Suitable places: Lawn, Garden, or to be used to light the buildings.

产品特点说明

1. 极简的工业设计造型, 美学与实用的完美结合, 外观和结构专利。
2. 灯体主体部分采用高压压铸铝, 表面双层静电喷涂处理, 防腐性、抗老化, 延长使用寿命。
3. 透光罩采用丝印钢化玻璃, 提高了灯具整体的美观程度, 灵活的二次光学透镜配光, 根据实际需要多种光束角选择。
4. 采用高效率、高稳定性恒流驱动电源, 保证了光源的稳定工作, 降低光衰, 延长使用寿命。
5. 独立的电源腔体设计, 有效的保证了电源的散热, 延长电源使用寿命, 控制方式可多种选择: 单色、RGB内控、DMX512外控。
6. 采用硅胶橡胶密封结构设计, 有效保证了防护等级IP65。
7. 可旋转安装支架设计, 根据实际应用调节角度, 使得应用发挥到最佳状态, 并且整灯安装简便。

Product Description

1. Simple and practical design, Perfect aesthetic and practical union, patented appearance and structure technology.
2. High pressure Aluminium die-cast body, double anti-corrosion to expand the working life.
3. Tempered glass diffuser, effectively improve the transmission rate of light. Multiple Beam-angle choice.
4. High efficiency constant current driver, ensure the light source is maximum used.
5. Independent power supply recessed design, extend the power supply working life, Control Mode: Monochrome control; RGB inner control; DMX512 external control.
6. Using silicone rubber leakproof structure design to ensure the high level of IP rating (IP:65).
7. Rotatable mounting bracket design to achieve the best light efficiency.



配光曲线 Light Distribution Curve

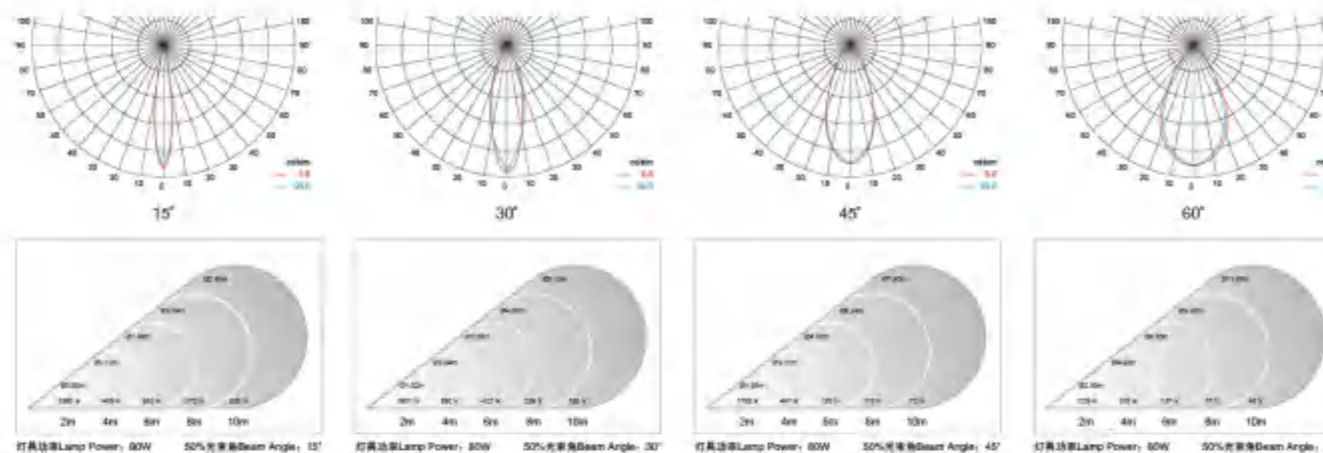

技术参数 Specification

名称	参数	类别	参数	类别	参数
额定功率 Rated Power	80W	光源 / 数量 LED Quantity	LED / 72pcs	输入电压 Input Voltage	DC 24V / AC 220V
色温 Color Temperature	3000K / 4000K / 5700K / RGB	50%光束角 50% Beam Angle	15° 30° 45° 60°	控制方式 Control Mode	ON-OFF / DMX512
使用寿命 Life	>30000H	防护等级 Protection Grade	IP 65	工作环境温度 Temperature of Working Condition	-25°C~50°C
灯具净重 Net Weight	6.6kg	中包规格 Package Specification	420x360x90mm	外箱规格 / 数量 Outside Box Specifications / Quantity	440x380x300mm / 3pcs



颜色选择 Color Selection

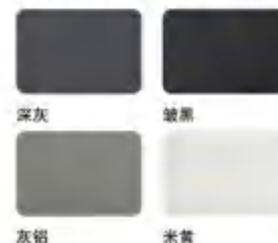

产品尺寸 Product Size

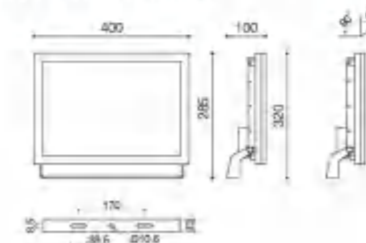

F0075

专利号 Num: 201230618726.3



敞开式散热片, 提高散热效果。
Open-type heat sink, improve heat dissipation efficiency.



RGB DMX512控制, 实现多种变化模式。
RGB DMX512 control, Various control mode combination.



自带控制功能和变化模式调节。
With control function and pattern-adjusting function.



钣金可旋转安装支架带刻度显示。
Rotatable mounting bracket with dial.

适用场合

主要应用于草坪、花园、公园等场所, 或用于照射建筑物。

The Application of Occasions

Suitable places: Lawn, Garden, or to be used to light the buildings.

产品特点说明

1. 极简的工业设计造型, 美学与实用的完美结合, 外观和结构专利。
2. 灯体主体部分采用高压压铸铝, 表面双层静电喷塑处理, 防腐性、抗老化, 延长使用寿命。
3. 透光罩采用丝印钢化玻璃, 提高了灯具整体的美观程度, 灵活的二次光学透镜配光, 根据实际需要多种光束角选择。
4. 采用高效率、高稳定性恒流驱动电源, 保证了光源的稳定工作, 降低光衰, 延长使用寿命。
5. 独立的电源腔体设计, 有效的保证了电源的散热, 延长电源使用寿命, 控制方式可多种选择: 单色、RGB内控、DMX512外控。
6. 采用硅橡胶密封结构设计, 有效保证了防护等级IP65。
7. 可旋转安装支架设计, 根据实际应用调节角度, 使得应用发挥到最佳状态, 并且整灯安装简便。

Product Description

1. Simple and practical design, Perfect aesthetic and practical union, patented appearance and structure technology.
2. High pressure Aluminium die-cast body, double anti-corrosion to expand the working life.
3. Tempered glass diffuser, effectively improve the transmission rate of light. Multiple Beam-angle choice.
4. High efficiency constant current driver, ensure the light source is maximum used.
5. Independent power supply recessed design, extend the power supply working life, Control Mode: Monochrome control; RGB inner control; DMX512 external control.
6. Using silicone rubber leakproof structure design to ensure the high level of IP rating (IP:65).
7. Rotatable mounting bracket design to achieve the best light efficiency.

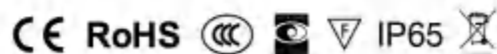

配光曲线 Light Distribution Curve

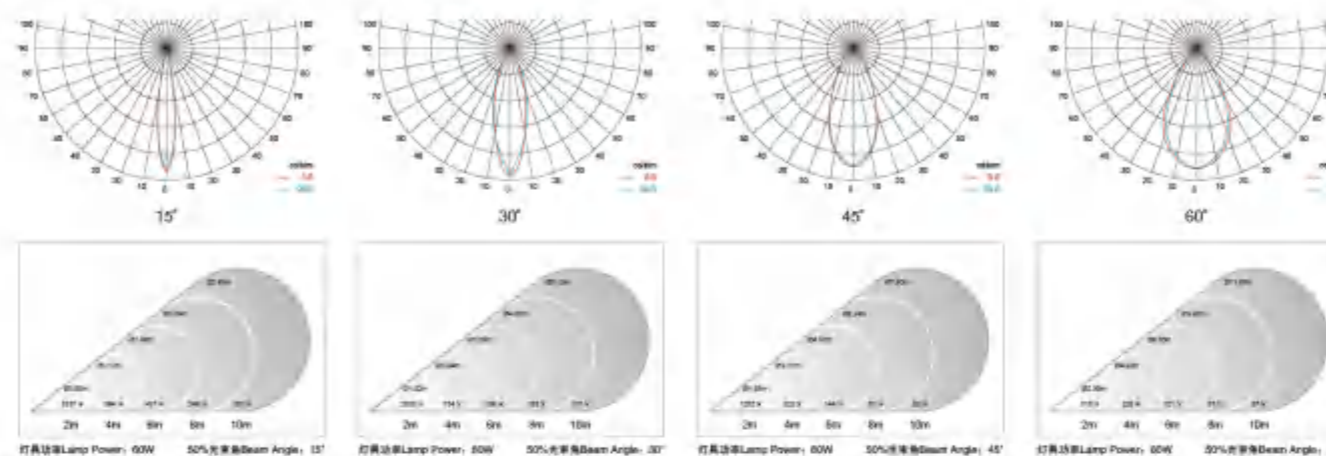

技术参数 Specification

中文	单位	类别	型号	中文	单位
额定功率 Rated Power	60W	光源 / 数量 LED Quantity	LED / 30pcs	输入电压 Input Voltage	DC 24V / AC 220V
色温 Color Temperature	3000K / 4000K / 5700K / RGB	50%光束角 50% Beam Angle	15° 30° 45° 60°	控制方式 Control Mode	ON-OFF / DMX512
使用寿命 Life	>30000H	防护等级 Protection Grade	IP 65	工作环境温度 Temperature of Working Condition	-25°C~50°C
灯具净重 Net Weight	3.7kg	中包规格 Package Specification	430x235x125mm	外箱规格 / 数量 Outside Box Specification / Quantity	490x450x280mm / 4pcs



颜色选择 Color Selection

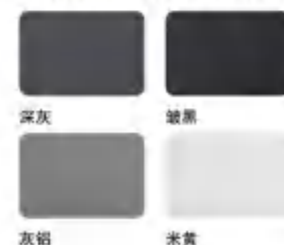

产品尺寸 Product Size

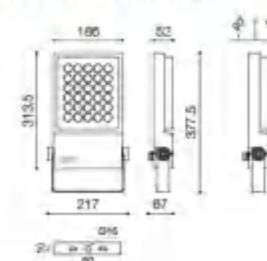

F0076

专利号 Num: 201230618706.6



敞开式散热片, 提高散热效果。
Open-type heat sink, improve heat dissipation efficiency.



RGB DMX512控制, 实现多种变化模式。
RGB DMX512 control, Various control mode combination.



自带控制功能和变化模式调节。
With control function and pattern-adjusting function.



钣金可旋转安装支架带刻度显示。
Rotatable mounting bracket with dial.

适用场合

主要应用于草坪、花园、公园等场所, 或用于照射建筑物。

The Application of Occasions

Suitable places: Lawn, Garden, or to be used to light the buildings.

产品特点说明

1. 极简的工业设计造型, 美学与实用的完美结合, 外观和结构专利。
2. 灯体主体部分采用高压压铸铝, 表面双层静电喷塑处理, 防腐性、抗老化, 延长使用寿命。
3. 透光罩采用丝印钢化玻璃, 提高了灯具整体的美观程度, 灵活的二次光学透镜配光, 根据实际需要多种光束角选择。
4. 采用高效率、高稳定性恒流驱动电源, 保证了光源的稳定工作, 降低光衰, 延长使用寿命。
5. 独立的电源腔体设计, 有效的保证了电源的散热, 延长电源使用寿命, 控制方式可多种选择: 单色、RGB内控、DMX512外控。
6. 采用硅橡胶密封结构设计, 有效保证了防护等级IP65。
7. 可旋转安装支架设计, 根据实际应用调节角度, 使得应用发挥到最佳状态, 并且整灯安装简便。

Product Description

1. Simple and practical design, Perfect aesthetic and practical union, patented appearance and structure technology.
2. High pressure Aluminium die-cast body, double anti-corrosion to expand the working life.
3. Tempered glass diffuser, effectively improve the transmission rate of light. Multiple Beam-angle choice.
4. High efficiency constant current driver, ensure the light source is maximum used.
5. Independent power supply recessed design, extend the power supply working life, Control Mode: Monochrome control; RGB inner control; DMX512 external control.
6. Using silicone rubber leakproof structure design to ensure the high level of IP rating (IP:65).
7. Rotatable mounting bracket design to achieve the best light efficiency.



配光曲线 Light Distribution Curve

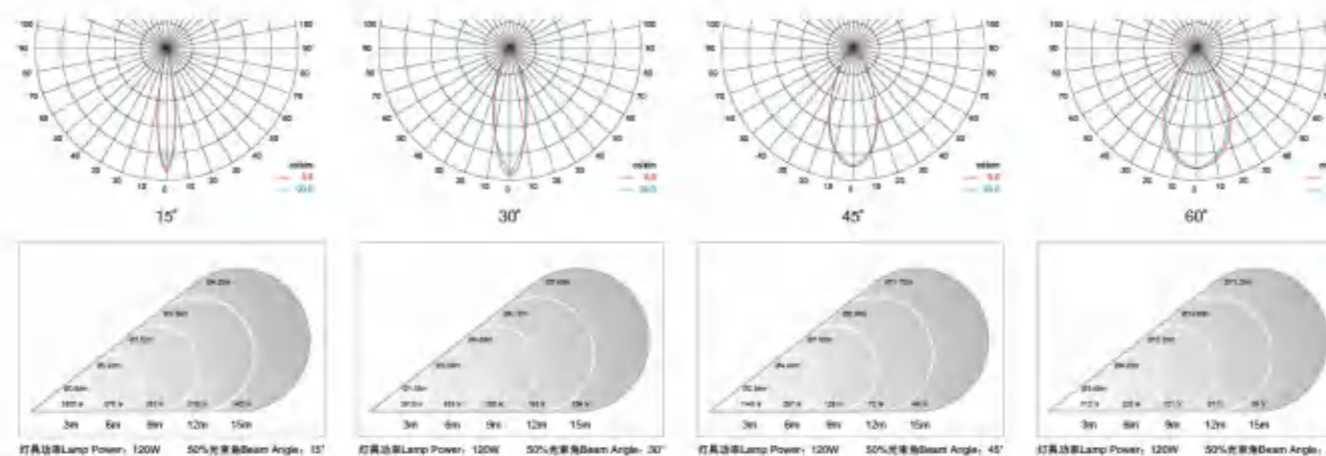

技术参数 Specification

类别 Category	参数 Parameter	类别 Category	参数 Parameter	类别 Category	参数 Parameter
额定功率 Rated Power	120W	光源 / 数量 LED Quantity	LED / 60pcs	输入电压 Input Voltage	DC 24V / AC 220V
色温 Color Temperature	3000K / 4000K / 5700K / RGB	50%光束角 50% Beam Angle	15° 30° 45° 60°	控制方式 Control Mode	ON-OFF / DMX512
使用寿命 Life	>30000H	防护等级 Protection Grade	IP 65	工作环境温度 Temperature of Working Condition	-25°C-50°C
灯具净重 Net Weight	9.5kg	中包规格 Package Specification	515x405x140mm	外箱规格 / 数量 Outside Box Specifications / Quantity	526x425x300mm / 2pcs



颜色选择 Color Selection

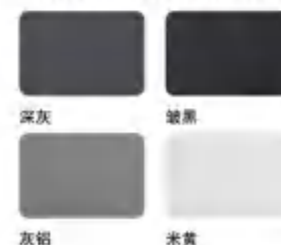

产品尺寸 Product Size

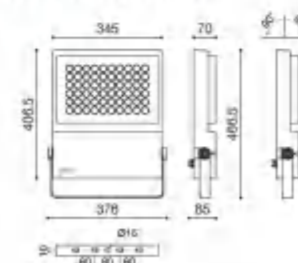

F0111-LED9

专利设计 DESIGN PATENT



F0111-LED3

专利设计 DESIGN PATENT



适用场合

主要应用于草坪、花园、公园等场所，或用于照射建筑物。

The Application of Occasions

Suitable places: Lawn, Garden or to be used to light the buildings.

产品特点说明

1. 极简的工业设计造型，美学与实用的完美结合，外观和结构专利。
2. 灯体主体部分采用高压压铸铝，表面双层静电喷塑处理，防腐性、抗老化，延长使用寿命。
3. 透光罩采用钢化玻璃，提高了灯具整体的美观程度，灵活的二次光学透镜配光，根据实际需要多种光束角选择。
4. 采用高效率、高稳定性恒流驱动电源，保证了光源的稳定工作，降低光衰，延长使用寿命。
5. 独立的电源腔体设计，有效的保证了电源的散热，延长电源使用寿命，控制方式可多种选择：单色、RGB内控、DMX512外控。
6. 采用硅橡胶密封结构设计，有效保证了防护等级IP65。
7. 可旋转安装支架设计，根据实际应用调节角度，使得应用发挥到最佳状态，并且整灯安装简便。

Product Description

1. Simple and practical design, Perfect aesthetic and practical union, patented appearance and structure technology.
2. High pressure Aluminium die-cast body, double anti-corrosion to expand the working life.
3. Tempered glass diffuser, effectively improve the transmission rate of light. Multiple Beam-angle choice.
4. High efficiency constant current driver, ensure the light source is maximum used.
5. Independent power supply recessed design, extend the power supply working life, Control Mode: Monochrome control; RGB inner control; DMX512 external control.
6. Using silicone rubber leakproof structure design to ensure the high level of IP rating (IP:65).
7. Rotatable mounting bracket design to achieve the best light efficiency.



钣金可旋转安装支架带刻度显示。
Rotatable mounting bracket with dial.



敞开式散热片，提高散热效果。
Open-type heat sink, improve heat dissipation efficiency.



配光曲线 Light Distribution Curve

F0111-LED9

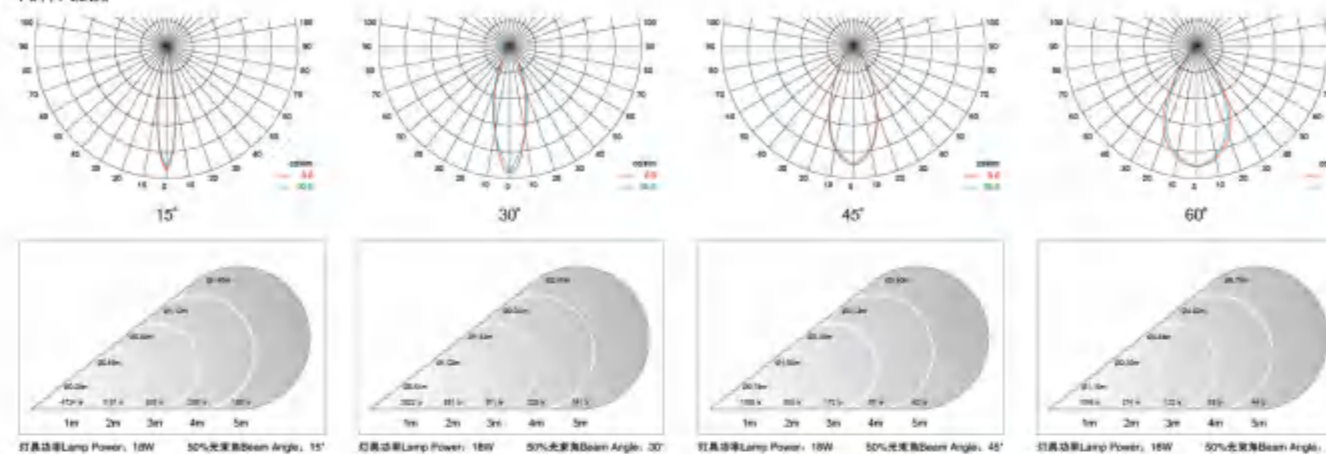

F0111-LED3

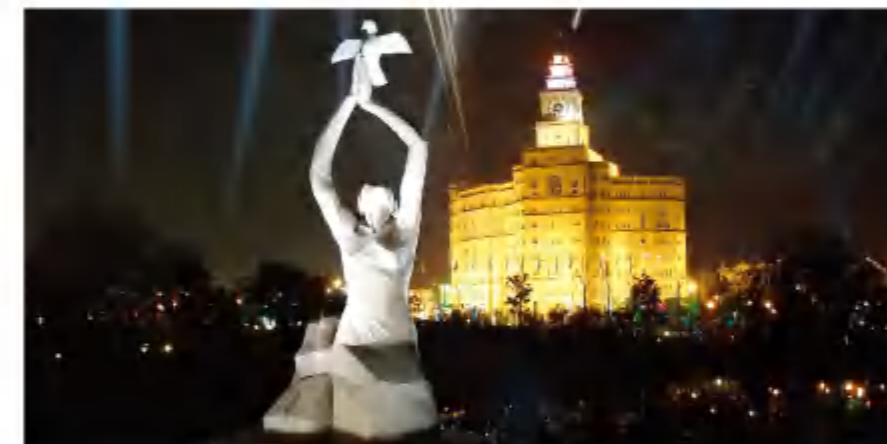
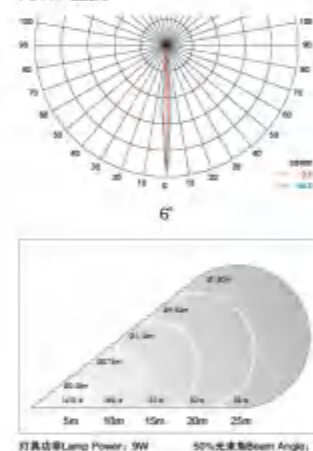

技术参数 Specification

类别 Category	型号 Model		系列 Series		规格 Specification		
	LED9	LED3	LED9	LED3	LED9	LED3	
额定功率 Rated Power	18W	9W	光源 / 数量 LED Quantity	LED / 9pcs	LED / 3pcs	输入电压 Input Voltage	DC 24V / AC 220V
色温 Color Temperature	3000K / 4000K / 5700K / RGB		50%光束角 50% Beam Angle	15° 30° 45° 60°	6°	控制方式 Control Mode	ON-OFF / DMX512
使用寿命 Life	>30000H		防护等级 Protection Grade	IP 65		工作环境温度 Temperature of Working Condition	-25°C~50°C
灯具净重 Net Weight	1.3kg		中包规格 Package Specification	150x150x140mm		外箱规格 / 数量 Outside Box Specifications / Quantity	470x320x310mm / 12pcs

颜色选择 Color Selection

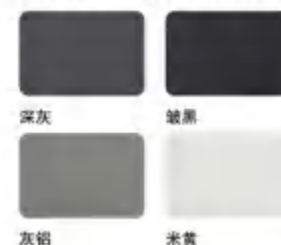

产品尺寸 Product Size

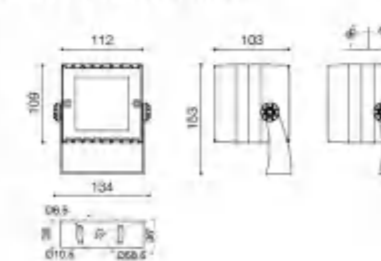

F0112-LED15

专利设计 DESIGN PATENT

F0112-LED6

专利设计 DESIGN PATENT



适用场合

主要应用于草坪、花园、公园等场所，或用于照射建筑物。

The Application of Occasions

Suitable places: Lawn, Garden, or to be used to light the buildings.

产品特点说明

1. 极简的工业设计造型，美学与实用的完美结合，外观和结构专利。
2. 灯体主体部分采用高压压铸铝，表面双层静电喷塑处理，防腐性、抗老化，延长使用寿命。
3. 透光罩采用钢化玻璃，提高了灯具整体的美观程度，灵活的二次光学透镜配光，根据实际需要多种光束角选择。
4. 采用高效率、高稳定性恒流驱动电源，保证了光源的稳定工作，降低光衰，延长使用寿命。
5. 独立的电源腔体设计，有效的保证了电源的散热，延长电源使用寿命，控制方式可多种选择：单色、RGB内控、DMX512外控。
6. 采用硅胶橡胶密封结构设计，有效保证了防护等级IP65。
7. 可旋转安装支架设计，根据实际应用调节角度，使得应用发挥到最佳状态，并且整灯安装简便。

Product Description

1. Simple and practical design, Perfect aesthetic and practical union, patented appearance and structure technology.
2. High pressure Aluminium die-cast body, double anti-corrosion to expand the working life.
3. Tempered glass diffuser, effectively improve the transmission rate of light. Multiple Beam-angle choice.
4. High efficiency constant current driver, ensure the light source is maximum used.
5. Independent power supply recessed design, extend the power supply working life, Control Mode: Monochrome control; RGB inner control; DMX512 external control.
6. Using silicone rubber leakproof structure design to ensure the high level of IP rating (IP:65).
7. Rotatable mounting bracket design to achieve the best light efficiency.



钣金可旋转安装支架带刻度显示。
Rotatable mounting bracket with dial.



敞开式散热片，提高散热效果。
Open-type heat sink, improve heat dissipation efficiency.

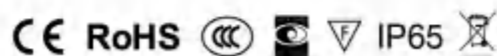

配光曲线 Light Distribution Curve

F0112-LED15

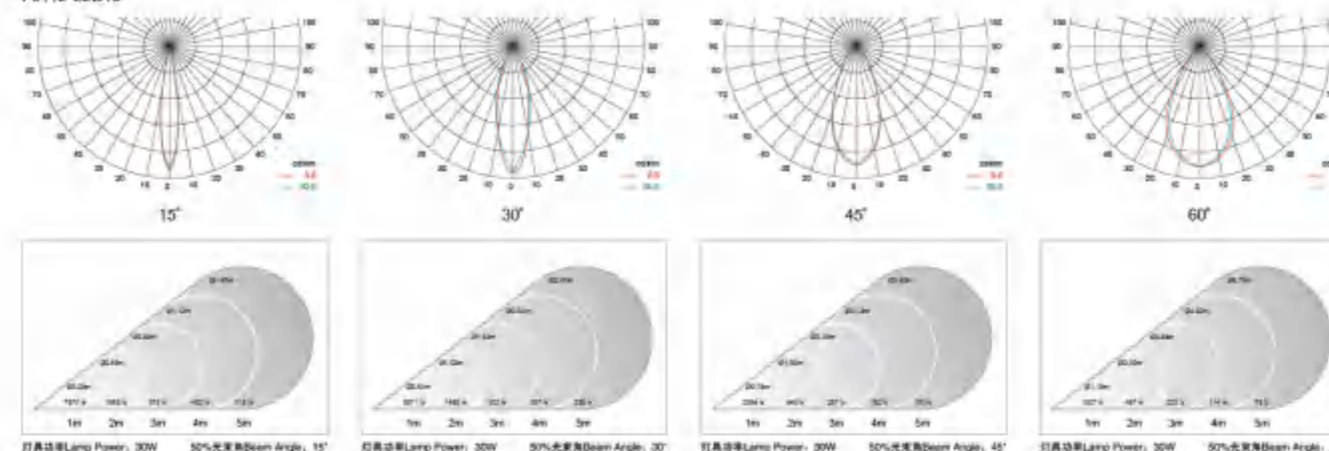

F0112-LED6

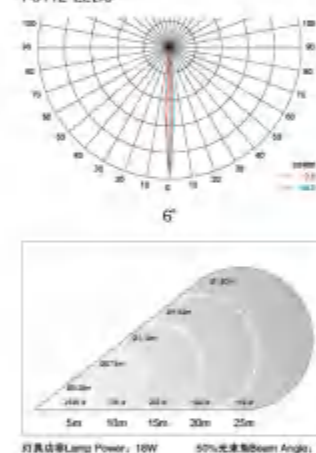

技术参数 Specification

类别	型号		类别		型号		
	LED15	LED6	LED15	LED6	LED15	LED6	
额定功率 Rated Power	30W	18W	光源 / 数量 LED Quantity	LED / 15pcs	LED / 6pcs	输入电压 Input Voltage	DC: 24V / AC: 220V
色温 Color Temperature	3000K / 4000K / 5700K / RGB		50%光束角 50% Beam Angle	15° 30° 45° 60°	6°	控制方式 Control Mode	ON-OFF / DMX512
使用寿命 Life	>30000H		防护等级 Protection Grade	IP 65		工作环境温度 Temperature of Working Condition	-25°C~50°C
灯具净重 Net Weight	2.2kg		中包规格 Package Specification	200x180x170mm		外箱规格 / 数量 Outside Box Specifications / Quantity	420x380x370mm / 8pcs

颜色选择 Color Selection

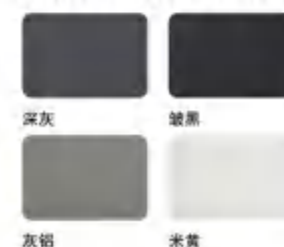

产品尺寸 Product Size

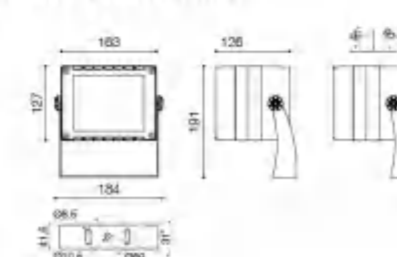

F0113-LED30

专利设计 DESIGN PATENT



F0113-LED12

专利设计 DESIGN PATENT



适用场合

主要应用于草坪、花园、公园等场所，或用于照射建筑物。

The Application of Occasions

Suitable places: Lawn, Garden or to be used to light the buildings.

产品特点说明

1. 极简的工业设计造型，美学与实用的完美结合，外观和结构专利。
2. 灯体主体部分采用高压压铸铝，表面双层静电喷塑处理，防腐性、抗老化，延长使用寿命。
3. 透光罩采用丝印钢化玻璃，提高了灯具整体的美观程度，灵活的二次光学透镜配光，根据实际需要多种光束角选择。
4. 采用高效率、高稳定性恒流驱动电源，保证了光源的稳定工作，降低光衰，延长使用寿命。
5. 独立的电源腔体设计，有效的保证了电源的散热，延长电源使用寿命，控制方式可多种选择：单色、RGB内控、DMX512外控。
6. 采用硅橡胶密封结构设计，有效保证了防护等级IP65。
7. 可旋转安装支架设计，根据实际应用调节角度，使得应用发挥到最佳状态，并且整灯安装简便。

Product Description

1. Simple and practical design, Perfect aesthetic and practical union, patented appearance and structure technology.
2. High pressure Aluminium die-cast body, double anti-corrosion to expand the working life.
3. Tempered glass diffuser, effectively improve the transmission rate of light. Multiple Beam-angle choice.
4. High efficiency constant current driver, ensure the light source is maximum used.
5. Independent power supply recessed design, extend the power supply working life, Control Mode: Monochrome control; RGB inner control; DMX512 external control.
6. Using silicone rubber leakproof structure design to ensure the high level of IP rating (IP:65).
7. Rotatable mounting bracket design to achieve the best light efficiency.



钣金可旋转安装支架带刻度显示。
Rotatable mounting bracket with dial.



敞开式散热片，提高散热效果。
Open-type heat sink, improve heat dissipation efficiency.



配光曲线 Light Distribution Curve

F0113-LED30

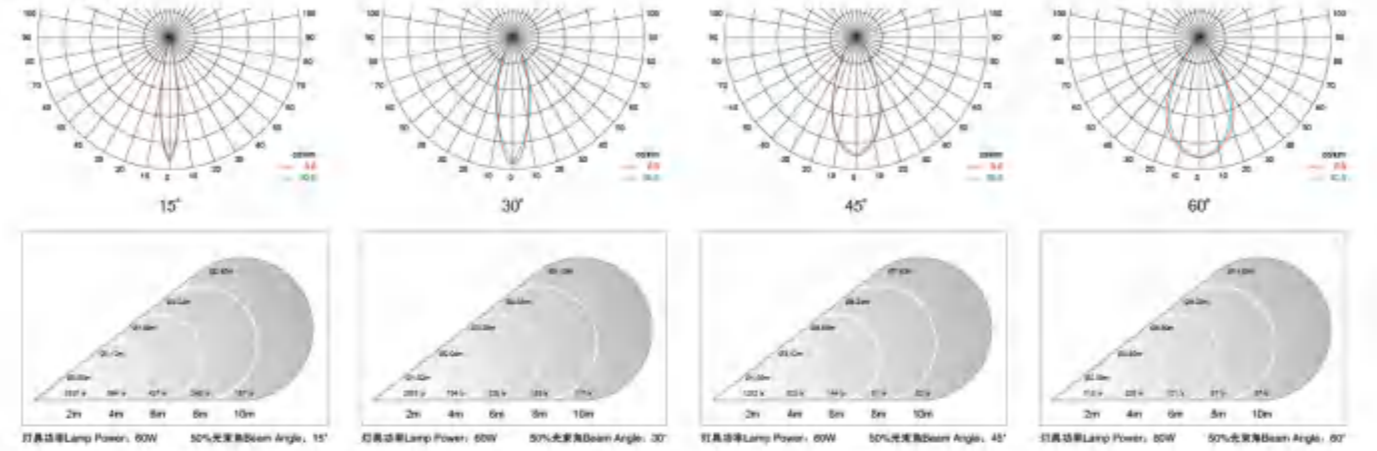

F0113-LED12

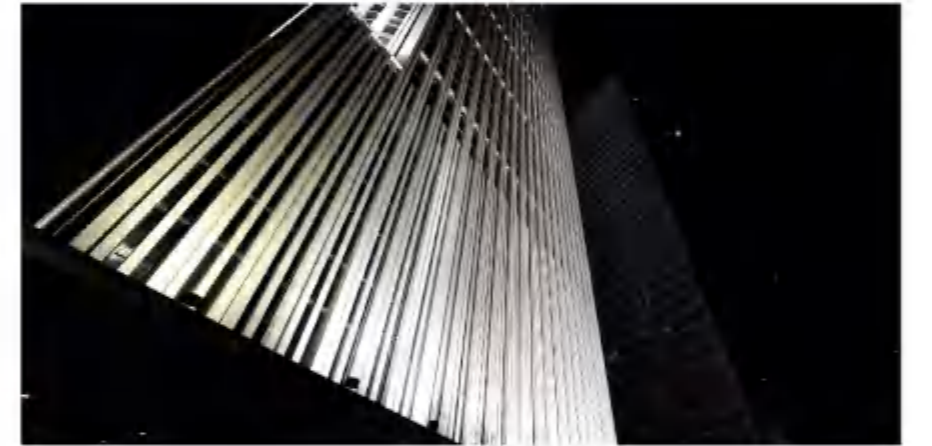
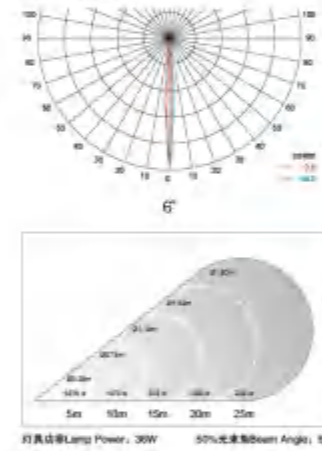

技术参数 Specification

类别	型号		类别	型号		类别	型号	
	LED30	LED12		LED30	LED12		LED30	LED12
额定功率 Rated Power	60W	36W	光源 / 数量 LED Quantity	LED / 30pcs	LED / 12pcs	输入电压 Input Voltage	DC 24V / AC 220V	
色温 Color Temperature	3000K / 4000K / 5700K / RGB		50%光束角 50% Beam Angle	15° 30° 45° 60°	6°	控制方式 Control Mode	ON-OFF / DMX512	
使用寿命 Life	>30000H		防护等级 Protective Grade	IP 65		工作环境温度 Temperature of Working Condition	-25°C~50°C	
灯具净重 Net Weight	3.9kg		中包规格 Package Specification	250x220x170mm		外箱规格 / 数量 Outside Box Specifications / Quantity	520x460x200mm / 4pcs	

颜色选择 Color Selection

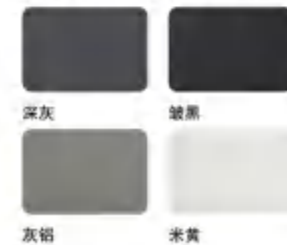

产品尺寸 Product Size

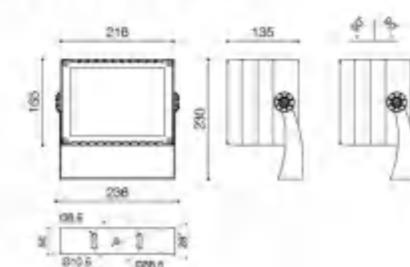

F0107-1LED18

专利设计 DESIGN PATENT



适用场合

主要应用于草坪、花园、公园等场所，或用于照射建筑物。

The Application of Occasions

Suitable places: Lawn, Garden or to be used to light the buildings.

产品特点说明

1. 极简的工业设计造型，美学与实用的完美结合，外观和结构专利。
2. 灯体主体部分采用高压压铸铝，表面双层静电喷塑处理，防腐性、抗老化，保证8年以上的使用寿命。
3. 直接光学透镜二次配光，无玻璃，大大提升整灯光效。
4. 外置防水驱动，高效率、高稳定性恒流驱动电源，保证了光源的稳定工作，降低光衰，延长使用寿命。
5. 模块式独立散热，表面横向、纵向、垂直三向通风，加快散热。
6. 采用硅橡胶密封结构设计，有效保证了防护等级IP65。
7. 光源模组式，便于维护。

Product Description

1. Simple industrial design, perfect aesthetic and practical union, patented appearance and structure technology.
2. High pressure aluminium die-cast body, coated with outdoor used powder, double anti-corrosion to ensure 8 years long-life span.
3. Scientific optical lens design, without glass, greatly improve the luminous efficiency.
4. External water-proof driver, using high efficiency and stability constant current driver to extend working life.
5. Modules design independent speed up heat dissipation.
6. Using silicone rubber leakproof structure design to ensure the high level of IP rating(IP:65).
7. Light source module, easy maintenance.



钣金可旋转安装支架带刻度显示。
Rotatable mounting bracket with dial.



外置防水电源，便于维护。
External waterproof power supply, easy maintenance.



配光曲线 Light Distribution Curve

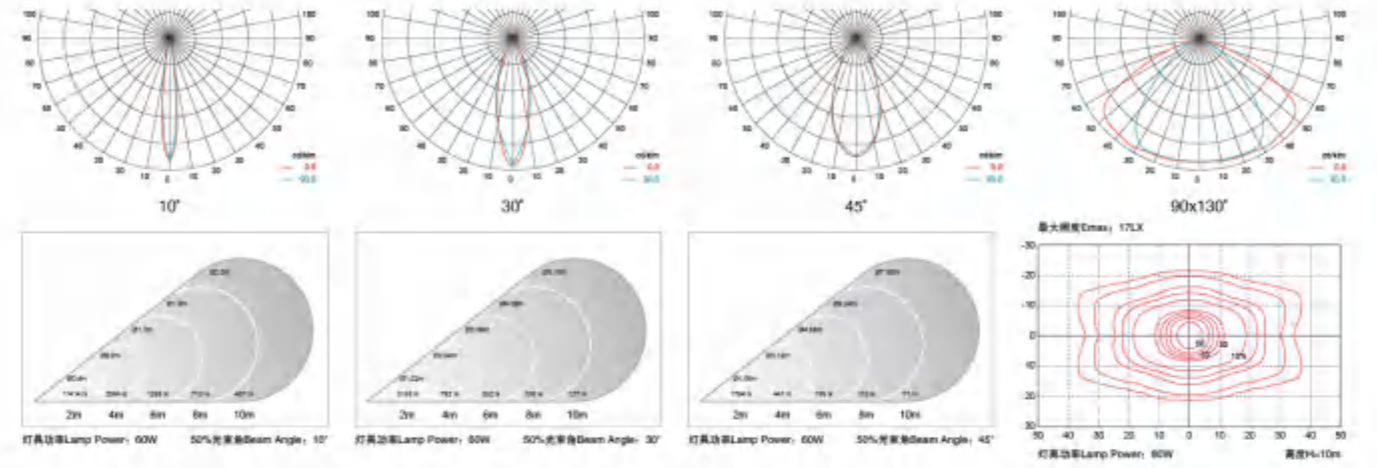

技术参数 Specification

类别	参数	类别	参数	类别	参数
额定功率 Rated Power	60W	光源 / 数量 LED Quantity	LED / 18pcs	输入电压 Input Voltage	DC 24V / AC 220V
色温 Color Temperature	3000K / 4000K / 5700K / RGB	50%光束角 50% Beam Angle	10° 30° 45° 90x130°	控制方式 Control Mode	ON-OFF / DMX512
使用寿命 Life	>30000H	防护等级 Protection Grade	IP 65	工作环境温度 Temperature of Working Condition	-25°C~50°C
灯具净重 Net Weight	3.4kg	中包规格 Package Specification	190x390x160mm	外箱规格 / 数量 Outside Box Specifications / Quantity	410x400x350mm / 4pcs



颜色选择 Color Selection

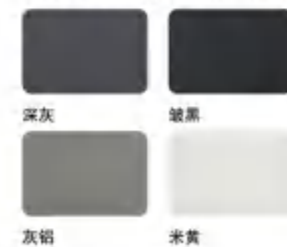

产品尺寸 Product Size

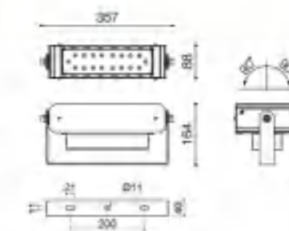

F0107-2LED36

专利设计 DESIGN PATENT



适用场合

主要应用于草坪、花园、公园等场所，或用于照射建筑物。

The Application of Occasions

Suitable places: Lawn, Garden or to be used to light the buildings.

产品特点说明

1. 极简的工业设计造型，美学与实用的完美结合，外观和结构专利。
2. 灯体主体部分采用高压压铸铝，表面双层静电喷涂处理，防腐性、抗老化，保证8年以上的使用寿命。
3. 直接光学透镜二次配光，无玻璃，大大提升整灯光效。
4. 外置防水驱动，高效率、高稳定性恒流驱动电源，保证了光源的稳定工作，降低光衰，延长使用寿命。
5. 模块式独立散热，表面横向、纵向、垂直三向通风，加快散热。
6. 采用硅橡胶密封结构设计，有效保证了防护等级IP65。
7. 光源模组式，便于维护。

Product Description

1. Simple industrial design, perfect aesthetic and practical union, patented appearance and structure technology.
2. High pressure aluminium die-cast body, coated with outdoor used powder, double anti-corrosion to ensure 8 years long-life span.
3. Scientific optical lens design, without glass, greatly improve the luminous efficiency.
4. External water-proof driver, using high efficiency and stability constant current driver to extend working life.
5. Modules design independent speed up heat dissipation.
6. Using silicone rubber leakproof structure design to ensure the high level of IP rating(IP:65).
7. Light source module, easy maintenance.



钣金可旋转安装支架带刻度显示。
Rotatable mounting bracket with dial.



外置防水电源，便于维护。
External waterproof power supply, easy maintenance.



配光曲线 Light Distribution Curve

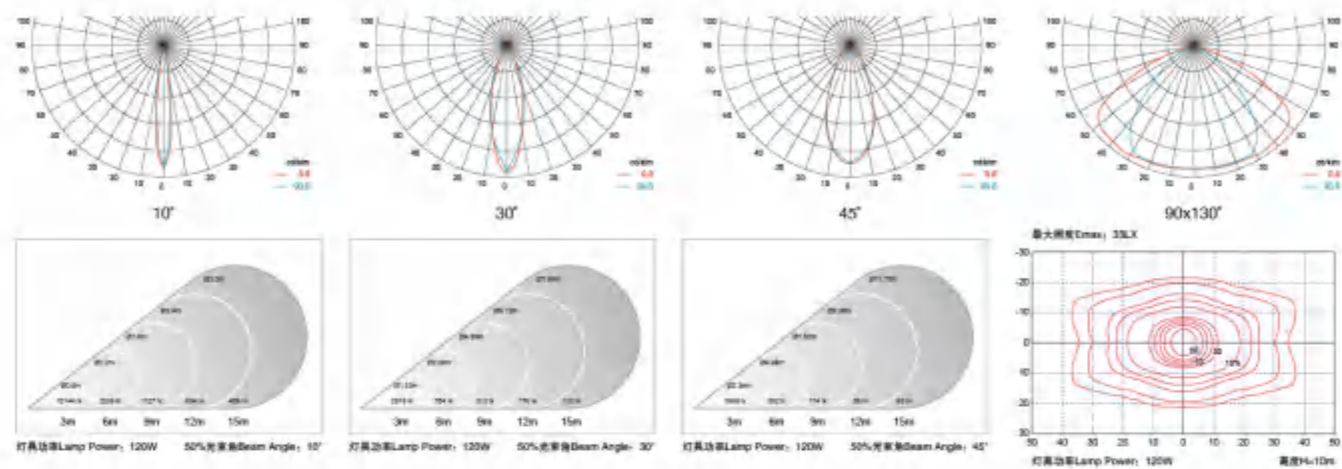

技术参数 Specification

类别	参数	类别	参数	类别	参数
额定功率 Rated Power	120W	光源 / 数量 LED Quantity	LED / 36pcs	输入电压 Input Voltage	DC 24V / AC 220V
色温 Color Temperature	3000K / 4000K / 5700K / RGB	50%光束角 50% Beam Angle	10° 30° 45° 90x130°	控制方式 Control Mode	ON-OFF / DMX512
使用寿命 Life	>30000H	防护等级 Protection Grade	IP 65	工作环境温度 Temperature of Working Condition	-25°C-50°C
灯具净重 Net Weight	4.8kg	中包规格 Package Specification	230x390x160mm	外箱规格 / 数量 Outside Box Specifications / Quantity	410x250x350mm / 2pcs



颜色选择 Color Selection

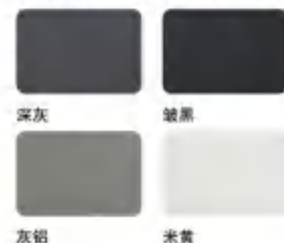

产品尺寸 Product Size

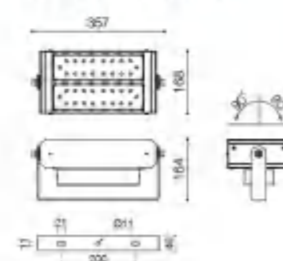

F0107-3LED54

专利设计 DESIGN PATENT



适用场合

主要应用于草坪、花园、公园等场所，或用于照射建筑物。

The Application of Occasions

Suitable places: Lawn, Garden or to be used to light the buildings.

产品特点说明

1. 极简的工业设计造型，美学与实用的完美结合，外观和结构专利。
2. 灯体主体部分采用高压压铸铝，表面双层静电喷塑处理，防腐性、抗老化，保证8年以上的使用寿命。
3. 直接光学透镜二次配光，无玻璃，大大提升整灯光效。
4. 外置防水驱动，高效率、高稳定性恒流驱动电源，保证了光源的稳定工作，降低光衰，延长使用寿命。
5. 模块式独立散热，表面横向、纵向、垂直三向通风，加快散热。
6. 采用硅橡胶密封结构设计，有效保证了防护等级IP65。
7. 光源模组式，便于维护。



钣金可旋转安装支架带刻度显示。
Rotatable mounting bracket with dial.



外置防水电源，便于维护。
External waterproof power supply, easy maintenance.

Product Description

1. Simple industrial design, perfect aesthetic and practical union, patented appearance and structure technology.
2. High pressure aluminium die-cast body, coated with outdoor used powder, double anti-corrosion to ensure 8 years long-life span.
3. Scientific optical lens design, without glass, greatly improve the luminous efficiency.
4. External water-proof driver, using high efficiency and stability constant current driver to extend working life.
5. Modules design independent speed up heat dissipation.
6. Using silicone rubber leakproof structure design to ensure the high level of IP rating(IP:65).
7. Light source module, easy maintenance.



配光曲线 Light Distribution Curve

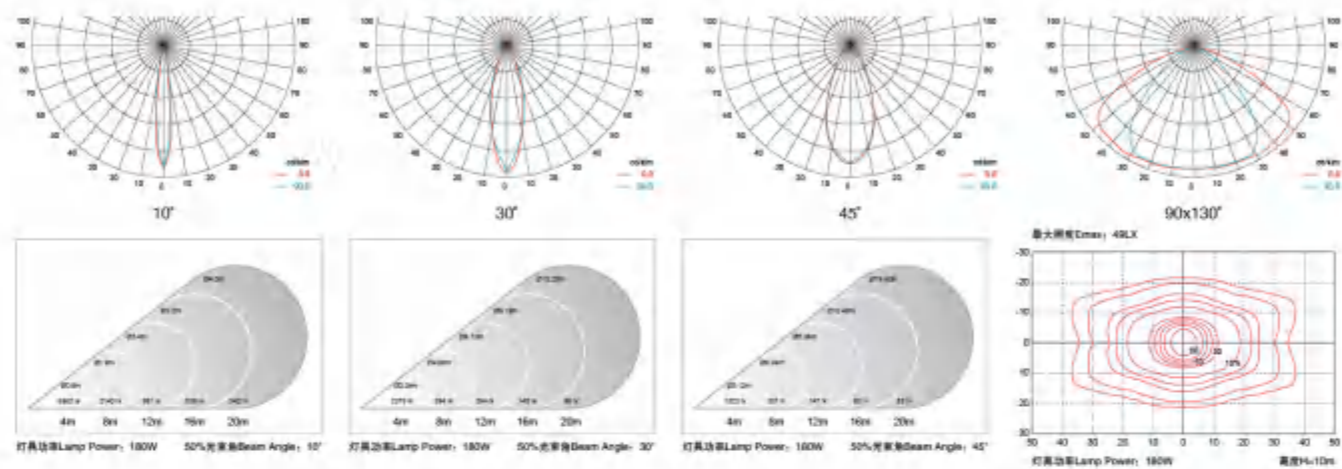

技术参数 Specification

类别	参数	类别	参数	类别	参数
额定功率 Rated Power	180W	光源 / 数量 LED Quantity	LED / 54pcs	输入电压 Input Voltage	DC 24V / AC 220V
色温 Color Temperature	3000K / 4000K / 5700K / RGB	50%光束角 50% Beam Angle	10° 30° 45° 90x130°	控制方式 Control Mode	ON-OFF / DMX512
使用寿命 Life	>30000H	防护等级 Protection Grade	IP 65	工作环境温度 Temperature of Working Condition	-25°C-50°C
灯具净重 Net Weight	6kg	中包规格 Package Specification	390x310x160mm	外箱规格 / 数量 Outside Box Specifications / Quantity	410x330x350mm / 2pcs



颜色选择 Color Selection

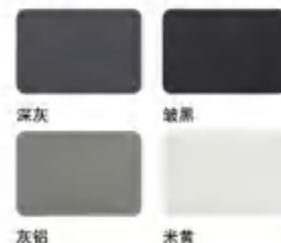

产品尺寸 Product Size

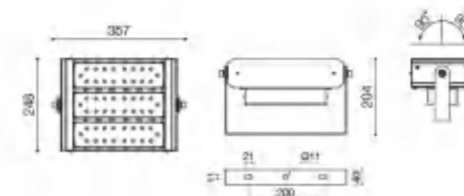

F0107-4LED72

专利设计 DESIGN PATENT



适用场合

主要应用于草坪、花园、公园等场所，或用于照射建筑物。

The Application of Occasions

Suitable places: Lawn, Garden or to be used to light the buildings.

产品特点说明

1. 极简的工业设计造型，美学与实用的完美结合，外观和结构专利。
2. 灯体主体部分采用高压压铸铝，表面双层静电喷涂处理，防腐性、抗老化，保证8年以上的使用寿命。
3. 直接光学透镜二次配光，无玻璃，大大提升整灯光效。
4. 外置防水驱动，高效率、高稳定性恒流驱动电源，保证了光源的稳定工作，降低光衰，延长使用寿命。
5. 模块式独立散热，表面横向、纵向、垂直三向通风，加快散热。
6. 采用硅橡胶密封结构设计，有效保证了防护等级IP65。
7. 光源模组式，便于维护。



钣金可旋转安装支架带刻度显示。
Rotatable mounting bracket with dial.



外置防水电源，便于维护。
External waterproof power supply, easy maintenance.

Product Description

1. Simple industrial design, perfect aesthetic and practical union, patented appearance and structure technology.
2. High pressure aluminium die-cast body, coated with outdoor used powder, double anti-corrosion to ensure 8 years long-life span.
3. Scientific optical lens design, without glass, greatly improve the luminous efficiency.
4. External water-proof driver, using high efficiency and stability constant current driver to extend working life.
5. Modules design independent speed up heat dissipation.
6. Using silicone rubber leakproof structure design to ensure the high level of IP rating(IP:65).
7. Light source module, easy maintenance.



配光曲线 Light Distribution Curve

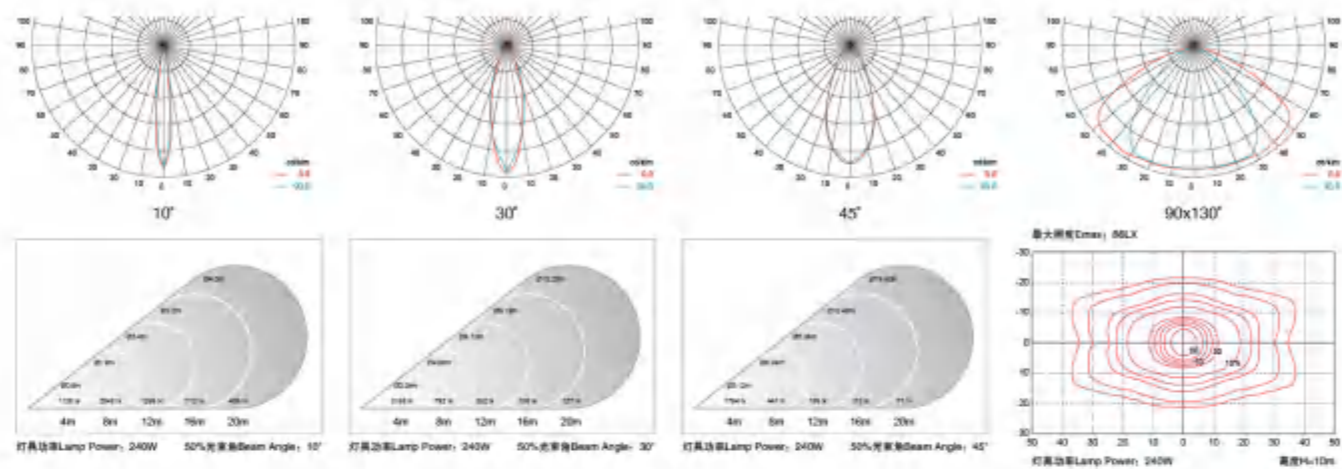

技术参数 Specification

类别	参数	类别	参数	类别	参数
额定功率 Rated Power	240W	光源 / 数量 LED / Qty	LED / 72pcs	输入电压 Input Voltage	DC 24V / AC 220V
色温 Color Temperature	3000K / 4000K / 5700K / RGB	50%光束角 50% Beam Angle	10° 30° 45° 90x130°	控制方式 Control Mode	ON-OFF / DMX512
使用寿命 Life	>30000H	防护等级 Protection Grade	IP 65	工作环境温度 Temperature of Working Condition	-25°C-50°C
灯具净重 Net Weight	7.3kg	中包规格 Package Specification	390x390x160mm	外箱规格 / 数量 Outside Box Specifications / Quantity	410x410x350mm / 2pcs



颜色选择 Color Selection

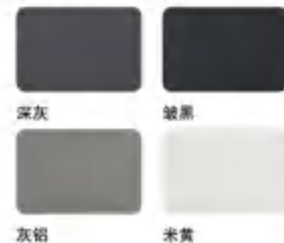

产品尺寸 Product Size

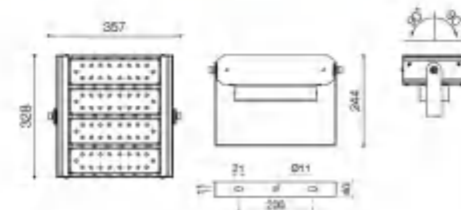

F0107-5LED90

专利设计 DESIGN PATENT



适用场合

主要应用于草坪、花园、公园等场所，或用于照射建筑物。

The Application of Occasions

Suitable places: Lawn, Garden or to be used to light the buildings.

产品特点说明

1. 极简的工业设计造型，美学与实用的完美结合，外观和结构专利。
2. 灯体主体部分采用高压压铸铝，表面双层静电喷塑处理，防腐性、抗老化，保证8年以上的使用寿命。
3. 直接光学透镜二次配光，无玻璃，大大提升整灯光效。
4. 外置防水驱动，高效率、高稳定性恒流驱动电源，保证了光源的稳定工作，降低光衰，延长使用寿命。
5. 模块式独立散热，表面横向、纵向、垂直三向通风，加快散热。
6. 采用硅橡胶密封结构设计，有效保证了防护等级IP65。
7. 光源模组式，便于维护。



钣金可旋转安装支架带刻度显示。
Rotatable mounting bracket with dial.



外置防水电源，便于维护。
External waterproof power supply, easy maintenance.

Product Description

1. Simple industrial design, perfect aesthetic and practical union, patented appearance and structure technology.
2. High pressure aluminium die-cast body, coated with outdoor used powder, double anti-corrosion to ensure 8 years long-life span.
3. Scientific optical lens design, without glass, greatly improve the luminous efficiency.
4. External water-proof driver, using high efficiency and stability constant current driver to extend working life.
5. Modules design independent speed up heat dissipation.
6. Using silicone rubber leakproof structure design to ensure the high level of IP rating(IP:65).
7. Light source module, easy maintenance.



配光曲线 Light Distribution Curve

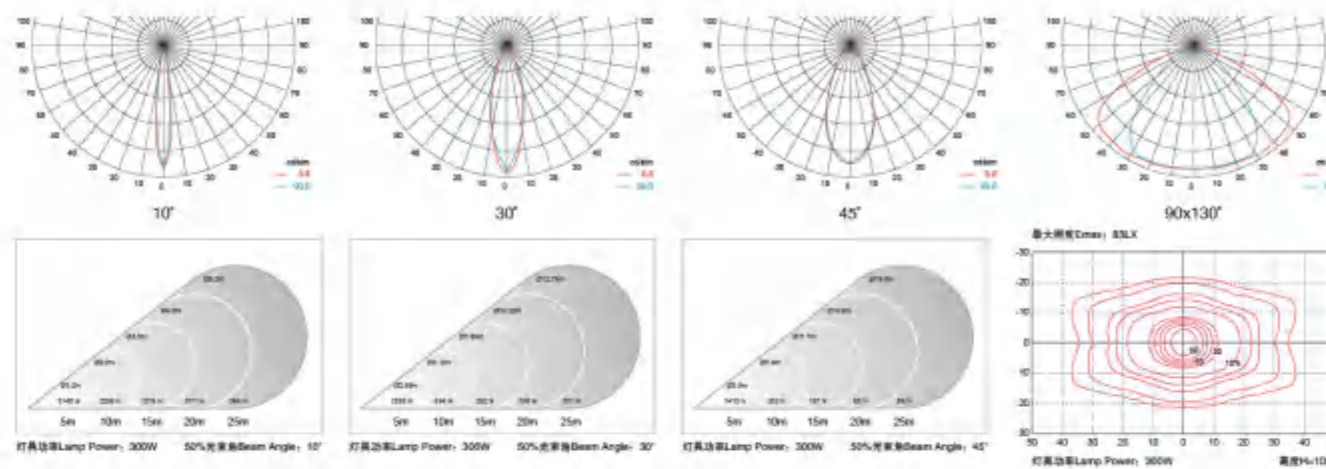

技术参数 Specification

类别	参数	类别	参数	类别	参数
额定功率 Rated Power	300W	光源 / 数量 LED Quantity	LED / 90pcs	输入电压 Input Voltage	DC 24V / AC 220V
色温 Color Temperature	3000K / 4000K / 5700K / RGB	50%光束角 50% Beam Angle	10° 30° 45° 90x130°	控制方式 Control Mode	ON-OFF / DMX512
使用寿命 Life	>30000H	防护等级 Protection Grade	IP 65	工作环境温度 Temperature of Working Condition	-25°C-50°C
灯具净重 Net Weight	3kg	中包规格 Package Specification	470x390x160mm	外箱规格 / 数量 Outside Box Specifications / Quantity	490x410x350mm / 2pcs



颜色选择 Color Selection

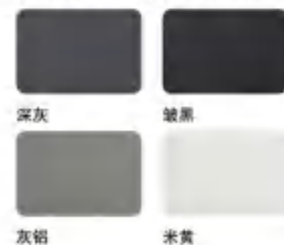

产品尺寸 Product Size

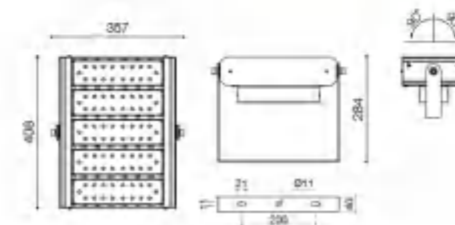

F0085-10W

专利号 Num: 201630151796.0

F0085-20W

专利号 Num: 201630151796.0

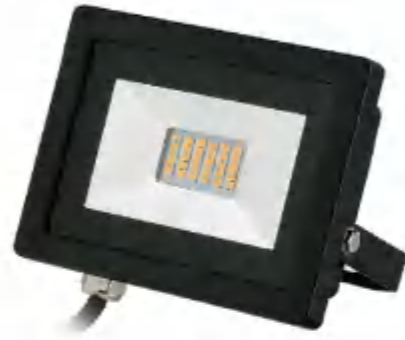
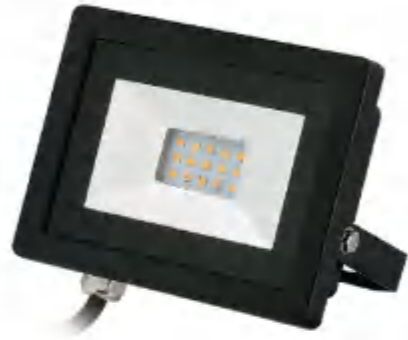

适用场合

主要应用于草坪、花园、公园等场所，或用于照射建筑物。

The Application of Occasions

Suitable places: Lawn, Garden or to be used to light the buildings.



旋转支架设计，可调角度。
Rotary support design, adjustable angle.

产品特点说明

1. 主体采用优质压铸铝材质，表面静电喷塑，颜色可多种选择。
2. 透光采用超白钢化玻璃，高透光率。
3. 合理的二次光学配光设计，满足实际场景使用。
4. 可旋转安装支架设计，提高实际场景的使用性能。
5. 适用于园林、楼宇、桥梁等亮化工程。



定制防水接头，提高性能和美观度。
Custom waterproof joints to improve performance and beauty.

Product Description

1. High pressure aluminium die-cast body, surface electrostatic spray, color customized.
2. Ultrawhite tempered glass diffuser, effectively improve the transmission rate of light.
3. Scientific design meets actual scene using.
4. Rotatable mount bracket design improves actual scene usability.
5. Suitable place: Garden, building, bridge, etc.

CE RoHS CCC IP65

配光曲线 Light Distribution Curve

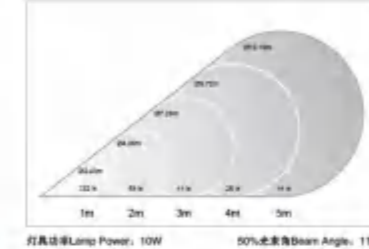
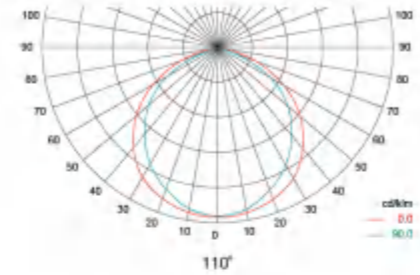

10W

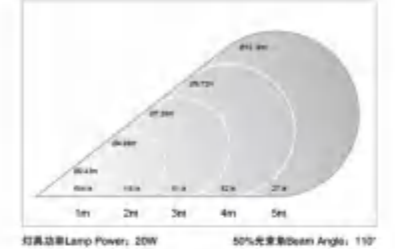

20W

技术参数 Specification

类别 Item	参数 Parameter		类别 Item	参数 Parameter		类别 Item	参数 Parameter	
	10W	20W		10W	20W		10W	20W
额定功率 Rated Power	10W	20W	光源 / 数量 LED Quantity	LED / 15pcs	LED / 30pcs	输入电压 Input Voltage	DC 24V / AC 220V	
色温 Color Temperature	3000K / 4000K / 5700K / RGB		50%光束角 50% Beam Angle	110°		控制方式 Control Mode	ON-OFF	
使用寿命 Life	>30000H		防护等级 Protection Grade	IP 65		工作环境温度 Temperature of Working Condition	-25°C~50°C	
灯具净重 Net Weight	0.5kg		中包规格 Package Specification	140x120x45mm		外箱规格 / 数量 Outside Box Specifications / Quantity	380x300x200mm / 24pcs	



颜色选择 Color Selection

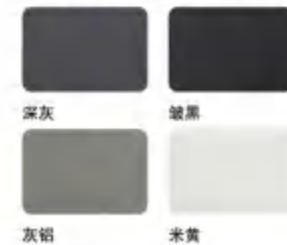

产品尺寸 Product Size

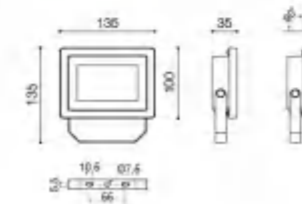

F0085-30W

专利号 Num: 201630151756.6

F0085-50W

专利设计 DESIGN PATENT



适用场合

主要应用于草坪、花园、公园等场所，或用于照射建筑物。

The Application of Occasions

Suitable places: Lawn, Garden or to be used to light the buildings.

产品特点说明

1. 主体采用优质压铸铝材质，表面静电喷塑，颜色可多种选择。
2. 透光采用超白钢化玻璃，高透光率。
3. 合理的二次光学配光设计，满足实际场景使用。
4. 可旋转安装支架设计，提高实际场景的使用性能。
5. 适用于园林、楼宇、桥梁等亮化工程。

Product Description

1. High pressure aluminium die-cast body, surface electrostatic spray, Color customized.
2. Ultrawhite tempered glass diffuser, effectively improve the transmission rate of light.
3. Scientific design meets actual scene using.
4. Rotatable mount bracket design improves actual scene usability.
5. Suitable place: Garden, building, bridge, etc.



旋转支架设计，可调角度。
Rotary support design, adjustable angle.



定制防水接头，提高性能和美观度。
Custom waterproof joints to improve performance and beauty.

CE RoHS CCC IP65

配光曲线 Light Distribution Curve

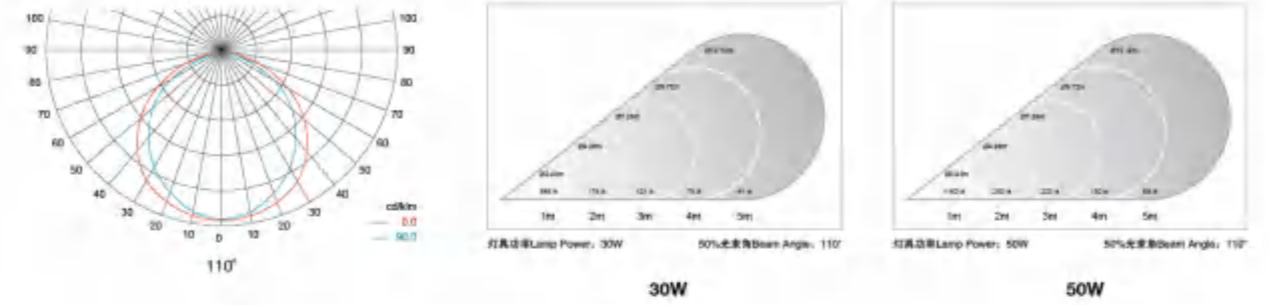

技术参数 Specification

类别	参数		类别	参数	
Type	30W	50W	Type	30W	50W
额定功率 Rated Power	30W	50W	光通 / 数量 LED Quantity	LED / 30pcs	LED / 48pcs
色温 Color Temperature	3000K / 4000K / 5700K / RGB		50%光束角 50% Beam Angle	110°	
使用寿命 Life	>30000H		防护等级 Protection Grade	IP 65	
灯具净重 Net Weight	1.1kg	2kg	中包规格 Package Specification	205x155x70mm	245x75x315mm
			外箱规格 / 数量 Outside Box Specifications / Quantity	485x430x160mm / 12pcs 510x310x335mm / 8pcs	
			输入电压 Input Voltage	DC 24V / AC 220V	
			控制方式 Control Mode	ON-OFF	
			工作环境温度 Temperature of Working Condition	-25°C~50°C	



颜色选择 Color Selection

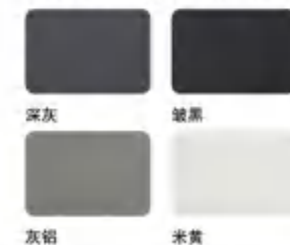

产品尺寸 Product Size

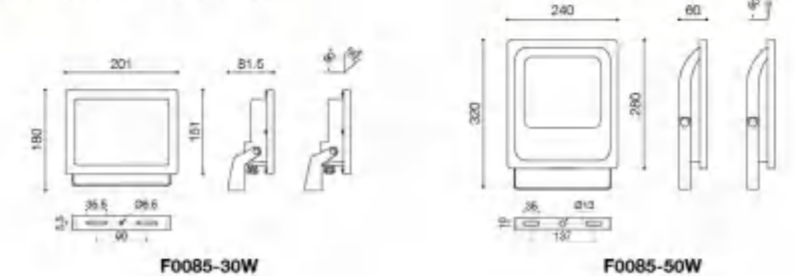

F0062 守护者系列

专利设计 DESIGN PATENT



适用场合

主要应用于草坪、花园、公园等场所，或用于照射建筑物。

The Application of Occasions

Suitable places: Lawn, Garden or to be used to light the buildings.

产品特点说明

1. 极简的工业设计造型，美学与实用的完美结合，外观和结构专利。
2. 灯体主体部分采用高压压铸铝，表面双层静电喷塑处理，防腐性、抗老化，延长使用寿命。
3. 透光罩采用丝印钢化玻璃，提高了灯具整体的美观程度，灵活的二次光学透镜配光，根据实际需要多种光束角选择。
4. 采用高效率、高稳定性恒流驱动电源，保证了光源的稳定工作，降低光衰，延长使用寿命。
5. 独立的电源腔体设计，有效的保证了电源的散热，延长电源使用寿命，控制方式可多种选择：单色、RGB内控、DMX512外控。
6. 采用硅橡胶密封结构设计，有效保证了防护等级IP65。
7. 可旋转安装支架设计，根据实际应用调节角度，使得应用发挥到最佳状态，并且整灯安装简便。

Product Description

1. Simple and practical design, Perfect aesthetic and practical union, patented appearance and structure technology.
2. High pressure Aluminium die-cast body, double anti-corrosion to expand the working life.
3. Tempered glass diffuser, effectively improve the transmission rate of light. Multiple Beam-angle choice.
4. High efficiency constant current driver, ensure the light source is maximum used.
5. Independent power supply recessed design, extend the power supply working life, Control Mode: Monochrome control; RGB inner control; DMX512 external control.
6. Using silicone rubber leakproof structure design to ensure the high level of IP rating (IP:65).
7. Rotatable mounting bracket design to achieve the best light efficiency.



旋转支架设计，可调角度。
Rotary support design, adjustable angle.



定制防水接头，提高性能和美观度。
Custom waterproof joints to improve performance and beauty.



配光曲线 Light Distribution Curve

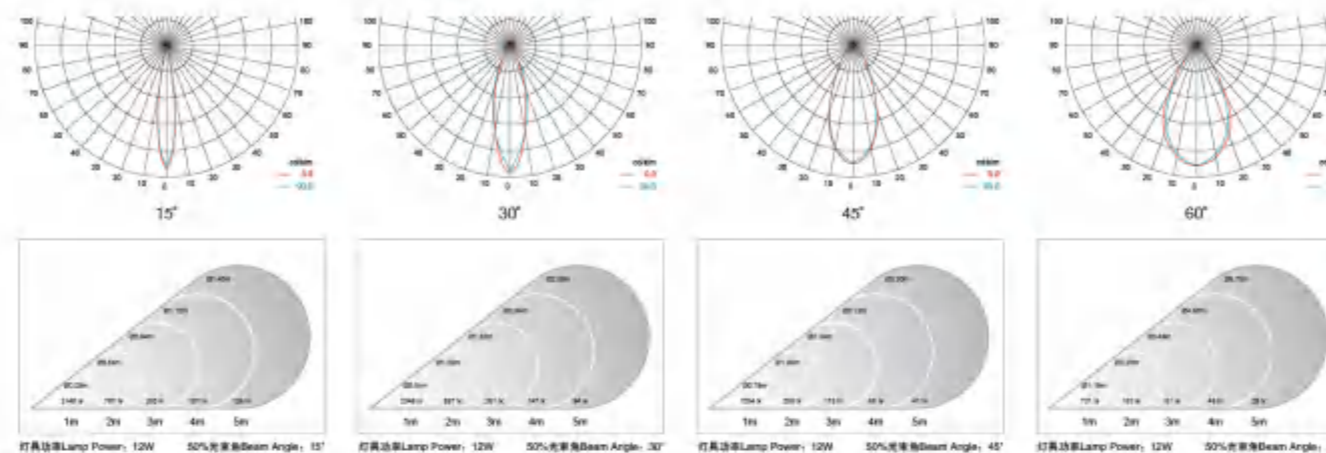

技术参数 Specification

类别	参数	类别	参数	类别	参数
额定功率 Rated Power	12W	光源 / 数量 LED Quantity	LED / 6pcs	输入电压 Input Voltage	DC 24V / AC 220V
色温 Color Temperature	3000K / 4000K / 5700K / RGB	50%光束角 50% Beam Angle	15° 30° 45° 60°	控制方式 Control Mode	ON-OFF / DMX512
使用寿命 Life	>30000H	防护等级 Protection Grade	IP 65	工作环境温度 Temperature of Working Condition	-25°C-50°C
灯具净重 Net Weight	1.3kg	中包规格 Package Specification	210x150x150mm	外箱规格 / 数量 Outside Box Specifications / Quantity	470x440x330mm / 12pcs



颜色选择 Color Selection

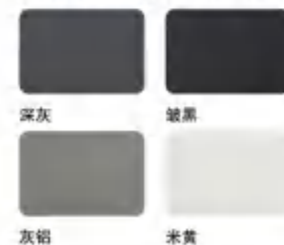

产品尺寸 Product Size

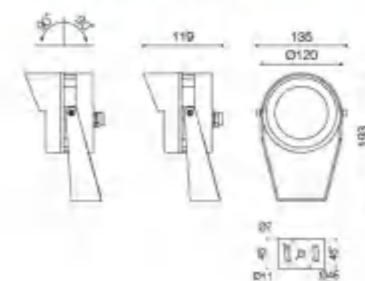

F0063 守护者系列

专利设计 DESIGN PATENT



适用场合

主要应用于草坪、花园、公园等场所，或用于照射建筑物。

The Application of Occasions

Suitable places: Lawn, Garden or to be used to light the buildings.

产品特点说明

1. 极简的工业设计造型，美学与实用的完美结合，外观和结构专利。
2. 灯体主体部分采用高压压铸铝，表面双层静电喷塑处理，防腐性、抗老化，延长使用寿命。
3. 透光罩采用丝印钢化玻璃，提高了灯具整体的美观程度，灵活的二次光学透镜配光，根据实际需要多种光束角选择。
4. 采用高效率、高稳定性恒流驱动电源，保证了光源的稳定工作，降低光衰，延长使用寿命。
5. 独立的电源腔体设计，有效的保证了电源的散热，延长电源使用寿命，控制方式可多种选择：单色、RGB内控、DMX512外控。
6. 采用硅橡胶密封结构设计，有效保证了防护等级IP65。
7. 可旋转安装支架设计，根据实际应用调节角度，使得应用发挥到最佳状态，并且整灯安装简便。

Product Description

1. Simple and practical design, Perfect aesthetic and practical union, patented appearance and structure technology.
2. High pressure Aluminium die-cast body, double anti-corrosion to expand the working life.
3. Tempered glass diffuser, effectively improve the transmission rate of light. Multiple Beam-angle choice.
4. High efficiency constant current driver, ensure the light source is maximum used.
5. Independent power supply recessed design, extend the power supply working life, Control Mode: Monochrome control; RGB inner control; DMX512 external control.
6. Using silicone rubber leakproof structure design to ensure the high level of IP rating (IP:65).
7. Rotatable mounting bracket design to achieve the best light efficiency.



旋转支架设计，可调角度。
Rotary support design, adjustable angle.



定制防水接头，提高性能和美观度。
Custom waterproof joints to improve performance and beauty.

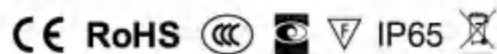

配光曲线 Light Distribution Curve

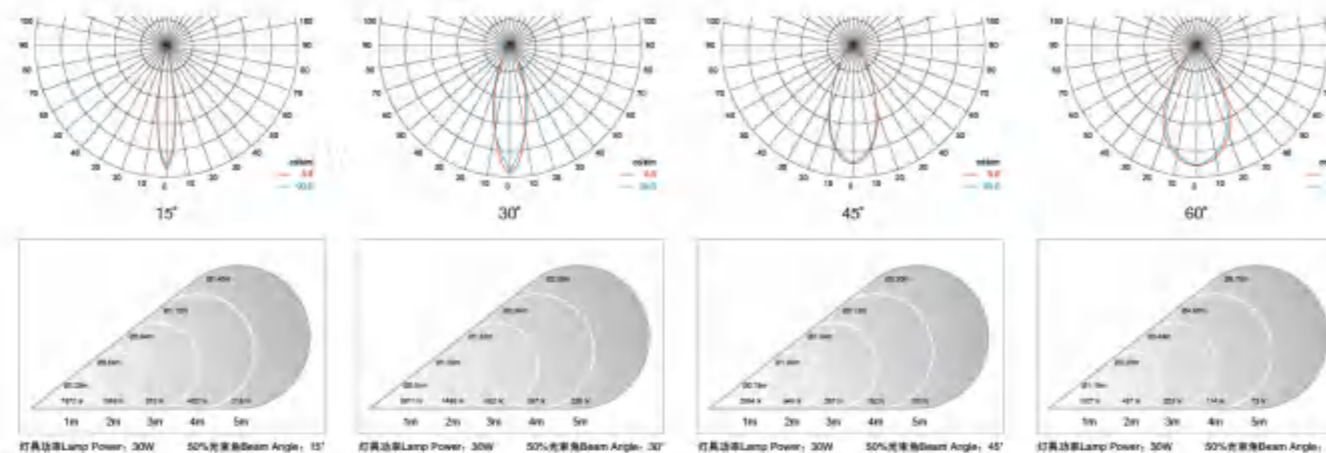

技术参数 Specification

类别 Category	参数 Parameter	类别 Category	参数 Parameter	类别 Category	参数 Parameter
额定功率 Rated Power	30W	光源 / 数量 LED Quantity	LED / 15pcs	输入电压 Input Voltage	DC 24V / AC 220V
色温 Color Temperature	3000K / 4000K / 5700K / RGB	50%光束角 50% Beam Angle	15° 30° 45° 60°	控制方式 Control Mode	ON-OFF / DMX512
使用寿命 Life	>30000H	防护等级 Protection Grade	IP 65	工作环境温度 Temperature of Working Condition	-25°C-50°C
灯具净重 Net Weight	2.3kg	中包规格 Package Specification	270x210x160mm	外箱规格 / 数量 Outside Box Specifications / Quantity	560x440x350mm / 8pcs



颜色选择 Color Selection

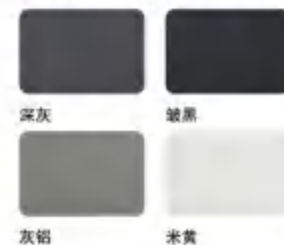

产品尺寸 Product Size

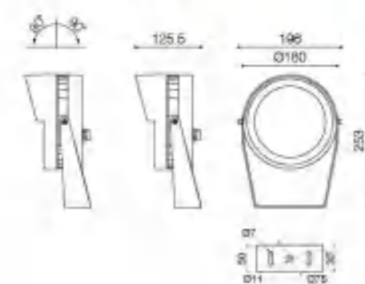

F0064 守护者系列

专利设计 DESIGN PATENT



适用场合

主要应用于草坪、花园、公园等场所，或用于照射建筑物。

The Application of Occasions

Suitable places: Lawn, Garden or to be used to light the buildings.

产品特点说明

1. 极简的工业设计造型，美学与实用的完美结合，外观和结构专利。
2. 灯体主体部分采用高压压铸铝，表面双层静电喷塑处理，防腐性、抗老化，延长使用寿命。
3. 透光罩采用丝印钢化玻璃，提高了灯具整体的美观程度，灵活的二次光学透镜配光，根据实际需要多种光束角选择。
4. 采用高效率、高稳定性恒流驱动电源，保证了光源的稳定工作，降低光衰，延长使用寿命。
5. 独立的电源腔体设计，有效的保证了电源的散热，延长电源使用寿命，控制方式可多种选择：单色、RGB内控、DMX512外控。
6. 采用硅橡胶密封结构设计，有效保证了防护等级IP65。
7. 可旋转安装支架设计，根据实际应用调节角度，使得应用发挥到最佳状态，并且整灯安装简便。



旋转支架设计，可调角度。
Rotary support design, adjustable angle.



定制防水接头，提高性能和美观度。
Custom waterproof joints to improve performance and beauty.

Product Description

1. Simple and practical design, Perfect aesthetic and practical union, patented appearance and structure technology.
2. High pressure Aluminium die-cast body, double anti-corrosion to expand the working life.
3. Tempered glass diffuser, effectively improve the transmission rate of light. Multiple Beam-angle choice.
4. High efficiency constant current driver, ensure the light source is maximum used.
5. Independent power supply recessed design, extend the power supply working life, Control Mode: Monochrome control; RGB inner control; DMX512 external control.
6. Using silicone rubber leakproof structure design to ensure the high level of IP rating (IP:65).
7. Rotatable mounting bracket design to achieve the best light efficiency.

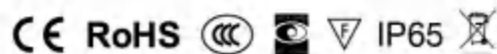

配光曲线 Light Distribution Curve

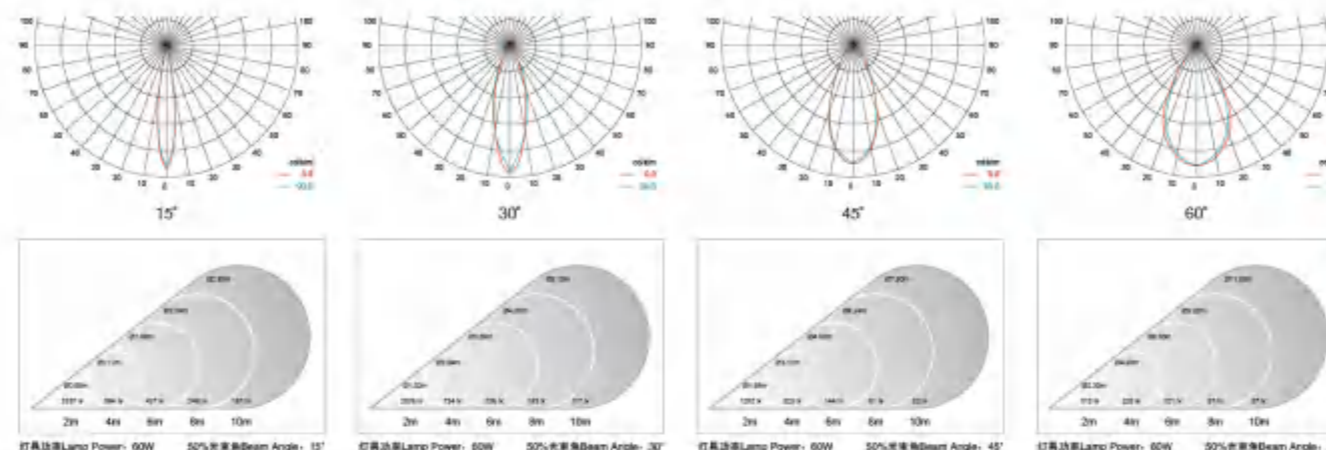

技术参数 Specification

类别 Category	参数 Parameter	类别 Category	参数 Parameter	类别 Category	参数 Parameter
额定功率 Rated Power	60W	光源 / 数量 LED Quantity	LED / 30pcs	输入电压 Input Voltage	DC 24V / AC 220V
色温 Color Temperature	3000K / 4000K / 5700K / RGB	50%光束角 50% Beam Angle	15° 30° 45° 60°	控制方式 Control Mode	ON-OFF / DMX512
使用寿命 Life	>30000H	防护等级 Protection Grade	IP 65	工作环境温度 Temperature of Working Condition	-25°C-50°C
灯具净重 Net Weight	3.6kg	中包规格 Package Specification	340x270x170mm	外箱规格 / 数量 Outside Box Specifications / Quantity	560x360x370mm / 4pcs



颜色选择 Color Selection

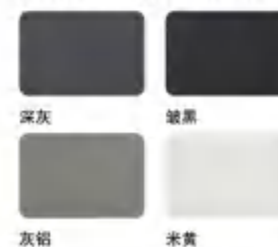

产品尺寸 Product Size

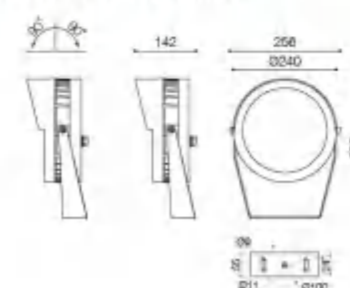

F0091

专利设计 DESIGN PATENT



敞开式散热片, 提高散热效果。
Open-type heat sink, improve heat dissipation efficiency.



RGB DMX512控制, 实现多种变化模式。
RGB DMX512 control, Various control mode combination.



钣金可旋转安装支架带刻度显示。
Rotatable mounting bracket with dial.

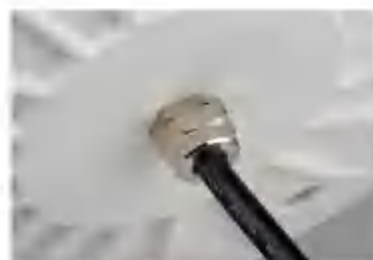

定制防水接头, 提高性能和美观度。
Custom waterproof joints to improve performance and beauty.

适用场合

主要应用于草坪、花园、公园等场所, 或用于照射建筑物。

The Application of Occasions

Suitable places: Lawn, Garden, or to be used to light the buildings.

产品特点说明

1. 极简的工业设计造型, 美学与实用的完美结合, 外观和结构专利。
2. 灯体主体部分采用高压压铸铝, 表面双层静电喷塑处理, 防腐性、抗老化, 延长使用寿命。
3. 透光罩采用丝印钢化玻璃, 提高了灯具整体的美观程度, 灵活的二次光学透镜配光, 根据实际需要多种光束角选择。
4. 采用高效率、高稳定性恒流驱动电源, 保证了光源的稳定工作, 降低光衰, 延长使用寿命。
5. 独立的电源腔体设计, 有效的保证了电源的散热, 延长电源使用寿命, 控制方式可多种选择: 单色、RGB内控、DMX512外控。
6. 采用硅橡胶密封结构设计, 有效保证了防护等级IP65。
7. 可旋转安装支架设计, 根据实际应用调节角度, 使得应用发挥到最佳状态, 并且整灯安装简便。

Product Description

1. Simple and practical design, Perfect aesthetic and practical union, patented appearance and structure technology.
2. High pressure Aluminium die-cast body, double anti-corrosion to expand the working life.
3. Tempered glass diffuser, effectively improve the transmission rate of light. Multiple Beam-angle choice.
4. High efficiency constant current driver, ensure the light source is maximum used.
5. Independent power supply recessed design, extend the power supply working life, Control Mode: Monochrome control; RGB inner control; DMX512 external control.
6. Using silicone rubber leakproof structure design to ensure the high level of IP rating (IP:65).
7. Rotatable mounting bracket design to achieve the best light efficiency.



配光曲线 Light Distribution Curve

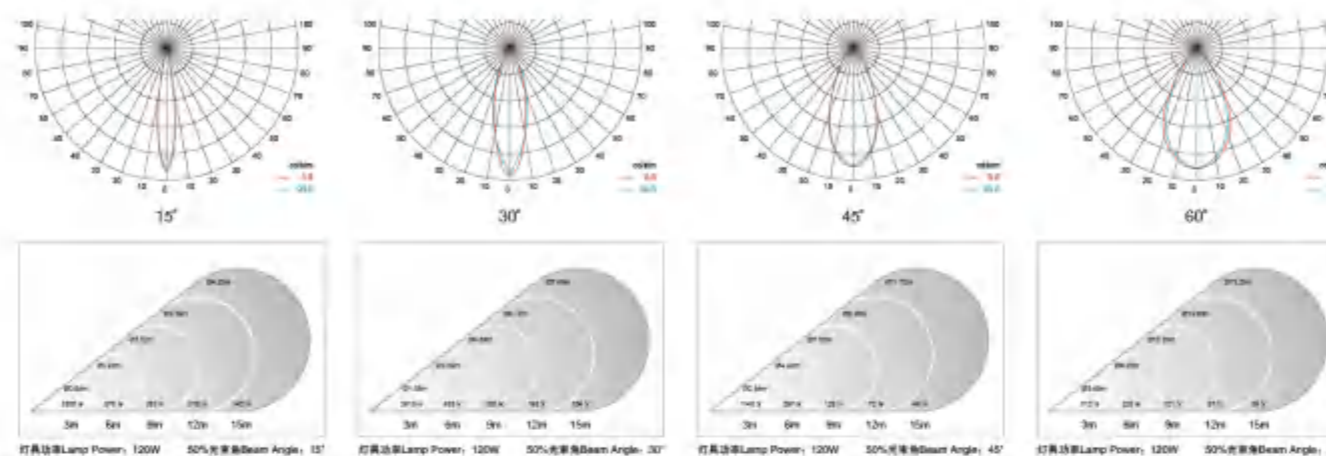

技术参数 Specification

项目	参数	类别	参数	类别	参数
额定功率 Rated Power	120W	光源 / 数量 LED Quantity	LED / 60pcs	输入电压 Input Voltage	DC 24V / AC 220V
色温 Color Temperature	3000K / 4000K / 5700K / RGB	50%光束角 50% Beam Angle	15° 30° 45° 60°	控制方式 Control Mode	ON-OFF / DMX512
使用寿命 Life	>30000H	防护等级 Protection Grade	IP 65	工作环境温度 Temperature of Working Condition	-25°C-50°C
灯具净重 Net Weight	7.5kg	中包规格 Package Specification	430x400x180mm	外箱规格 / 数量 Outside Box Specifications / Quantity	450x420x400mm / 2pcs



颜色选择 Color Selection

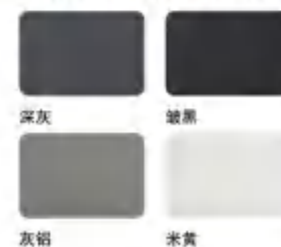

产品尺寸 Product Size

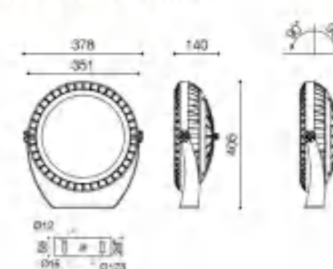

F0110

专利设计 DESIGN PATENT



敞开式散热片, 提高散热效果。
Open-type heat sink, improve heat dissipation efficiency.



RGB DMX512控制, 实现多种变化模式。
RGB DMX512 control, Various control mode combination.



钣金可旋转安装支架带刻度显示。
Rotatable mounting bracket with dial.



定制防水接头, 提高性能和美观度。
Custom waterproof joints to improve performance and beauty.

适用场合

主要应用于草坪、花园、公园等场所, 或用于照射建筑物。

The Application of Occasions

Suitable places: Lawn, Garden, or to be used to light the buildings.

产品特点说明

1. 极简的工业设计造型, 美学与实用的完美结合, 外观和结构专利。
2. 灯体主体部分采用高压压铸铝, 表面双层静电喷涂处理, 防腐性、抗老化, 延长使用寿命。
3. 透光罩采用钢化玻璃, 提高了灯具整体的美观程度, 灵活的二次光学透镜配光, 根据实际需要多种光束角选择。
4. 采用高效率、高稳定性恒流驱动电源, 保证了光源的稳定工作, 降低光衰, 延长使用寿命。
5. 独立的电源腔体设计, 有效的保证了电源的散热, 延长电源使用寿命, 控制方式可多种选择: 单色、RGB 内控、DMX512外控。
6. 采用硅橡胶密封结构设计, 有效保证了防护等级IP65。
7. 可旋转安装支架设计, 根据实际应用调节角度, 使得应用发挥到最佳状态, 并且整灯安装简便。

Product Description

1. Simple and practical design, Perfect aesthetic and practical union, patented appearance and structure technology.
2. High pressure Aluminium die-cast body, double anti-corrosion to expand the working life.
3. Tempered glass diffuser, effectively improve the transmission rate of light. Multiple Beam-angle choice.
4. High efficiency constant current driver, ensure the light source is maximum used.
5. Independent power supply recessed design, extend the power supply working life, Control Mode: Monochrome control; RGB inner control; DMX512 external control.
6. Using silicone rubber leakproof structure design to ensure the high level of IP rating (IP:65).
7. Rotatable mounting bracket design to achieve the best light efficiency.



配光曲线 Light Distribution Curve

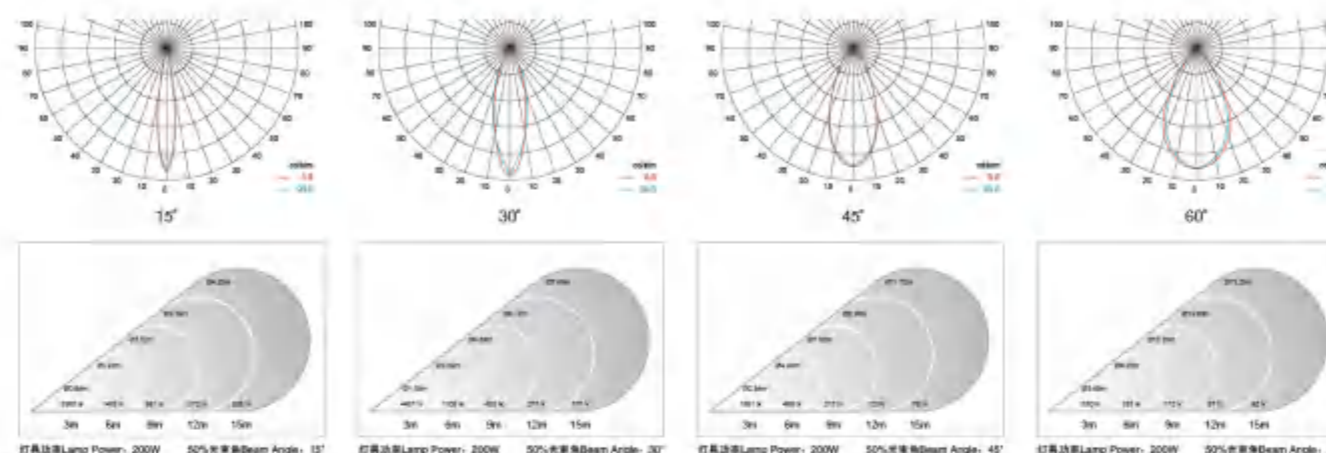

技术参数 Specification

项目	参数	类别	参数	类别	参数
额定功率 Rated Power	200W	光源 / 数量 LED Quantity	LED / 108pcs	输入电压 Input Voltage	DC 24V / AC 220V
色温 Color Temperature	3000K / 4000K / 5700K / RGB	50%光束角 50% Beam Angle	15° 30° 45° 60°	控制方式 Control Mode	ON-OFF / DMX512
使用寿命 Life	>30000H	防护等级 Protection Grade	IP 65	工作环境温度 Temperature of Working Condition	-25°C-50°C
灯具净重 Net Weight	15kg	中包规格 Package Specification	—	外箱规格 / 数量 Outside Box Specifications / Quantity	600x555x170mm / 1pcs



颜色选择 Color Selection

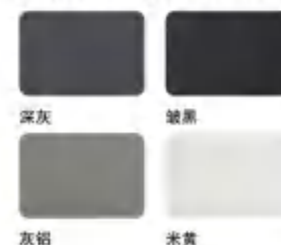

产品尺寸 Product Size

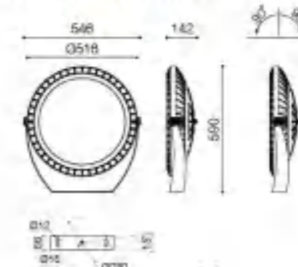

F0072A-LED6

专利号 Num: 201230618764.9



F0072A-G12 35W/70W

专利号 Num: 201230618764.9



适用场合

主要应用于草坪、花园、公园等场所，或用于照射建筑物。

The Application of Occasions

Suitable places: Lawn, Garden or to be used to light the buildings.

产品特点说明

1. 极简的工业设计造型，美学与实用的完美结合，外观和结构专利。
2. 灯体主体部分采用高压压铸铝，表面双层静电喷塑处理，防腐蚀、抗老化、延长使用寿命。
3. 透光罩采用钢化玻璃，提高了灯具整体的美观程度，灵活的二次光学透镜配光，根据实际需要多种光束角选择。
4. 采用高效率、高稳定性恒流驱动电源，保证了光源的稳定工作，降低光衰，延长使用寿命。
5. 散热主体表面设计了纵向散热片更有利于通风，增加散热面积，迅速散热，升华了灯具的整体美观程度。
6. 独立的电源腔体设计，有效的保证了电源的散热，延长电源使用寿命，控制方式可多种选择：单色、RGB 内控、DMX512 外控。
7. 采用硅橡胶密封结构设计，有效保证了防护等级IP65。



可调节照射角度，金属刻度盘显示。
Adjustable beam angle with metal dial.



压铸法兰底座，便于安装。
Aluminium die-cast flange base, convenient for installation.

CE RoHS CCC IP65

F0072B H1-LED6

专利号 Num: 201230618632.6



F0072B H1-G12 35W/70W

专利号 Num: 201230618632.6



适用场合

主要应用于草坪、花园、公园等场所，或用于照射建筑物。

The Application of Occasions

Suitable places: Lawn, Garden or to be used to light the buildings.

产品特点说明

1. 极简的工业设计造型，美学与实用的完美结合，外观和结构专利。
2. 灯体主体部分采用高压压铸铝，表面双层静电喷塑处理，防腐蚀、抗老化、延长使用寿命。
3. 透光罩采用钢化玻璃，提高了灯具整体的美观程度，灵活的二次光学透镜配光，根据实际需要多种光束角选择。
4. 采用高效率、高稳定性恒流驱动电源，保证了光源的稳定工作，降低光衰，延长使用寿命。
5. 散热主体表面设计了纵向散热片更有利于通风，增加散热面积，迅速散热，升华了灯具的整体美观程度。
6. 独立的电源腔体设计，有效的保证了电源的散热，延长电源使用寿命，控制方式可多种选择：单色、RGB 内控、DMX512 外控。
7. 采用硅橡胶密封结构设计，有效保证了防护等级IP65。



可调节照射角度，金属刻度盘显示。
Adjustable beam angle with metal dial.



压铸法兰底座，便于安装。
Aluminium die-cast flange base, convenient for installation.

CE RoHS CCC IP65

F0072C H2-2xLED6

专利号 Num: 201230619205.X

F0072C H2-2xG12 35W/70W

专利号 Num: 201230619205.X



适用场合

主要应用于草坪、花园、公园等场所，或用于照射建筑物。

The Application of Occasions

Suitable places: Lawn, Garden or to be used to light the buildings.

产品特点说明

1. 极简的工业设计造型，美学与实用的完美结合，外观和结构专利。
2. 灯体主体部分采用高压压铸铝，表面双层静电喷塑处理，防腐蚀、抗老化、延长使用寿命。
3. 透光罩采用丝印钢化玻璃，提高了灯具整体的美观程度，灵活的二次光学透镜配光，根据实际需要多种光束角选择。
4. 采用高效率、高稳定性恒流驱动电源，保证了光源的稳定工作，降低光衰，延长使用寿命。
5. 散热主体表面设计了横纵向散热片更有利于通风，增加散热面积，迅速散热，升华了灯具的整体美观程度。
6. 独立的电源腔体设计，有效的保证了电源的散热，延长电源使用寿命，控制方式可多种选择：单色、RGB 内控、DMX512 外控。
7. 采用硅橡胶密封结构设计，有效保证了防护等级IP65。



可调节照射角度，金属刻度盘显示。
Adjustable beam angle with metal dial.

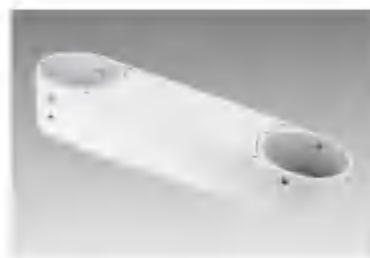

整体压铸安装横臂。
Aluminium die-cast mounting cross arm.

Product Description

1. Simple and practical design, Perfect aesthetic and practical union, patented appearance and structure technology.
2. High pressure Aluminium die-cast body, double anti-corrosion to expand the working life.
3. Tempered glass diffuser, effectively improve the transmission rate of light. Multiple Beam-angle choice.
4. High efficiency constant current driver, ensure the light source is maximum used.
5. Lateral and Axial Heat sink design on the light body surface, increase the efficiency of heat-dissipation.
6. Independent power supply recessed design, extend the power supply working life, Control Mode: Monochrome control; RGB inner control; DMX512 external control.
7. Using silicone rubber leakproof structure design to ensure the high level of IP rating(IP:65).



配光曲线 Light Distribution Curve

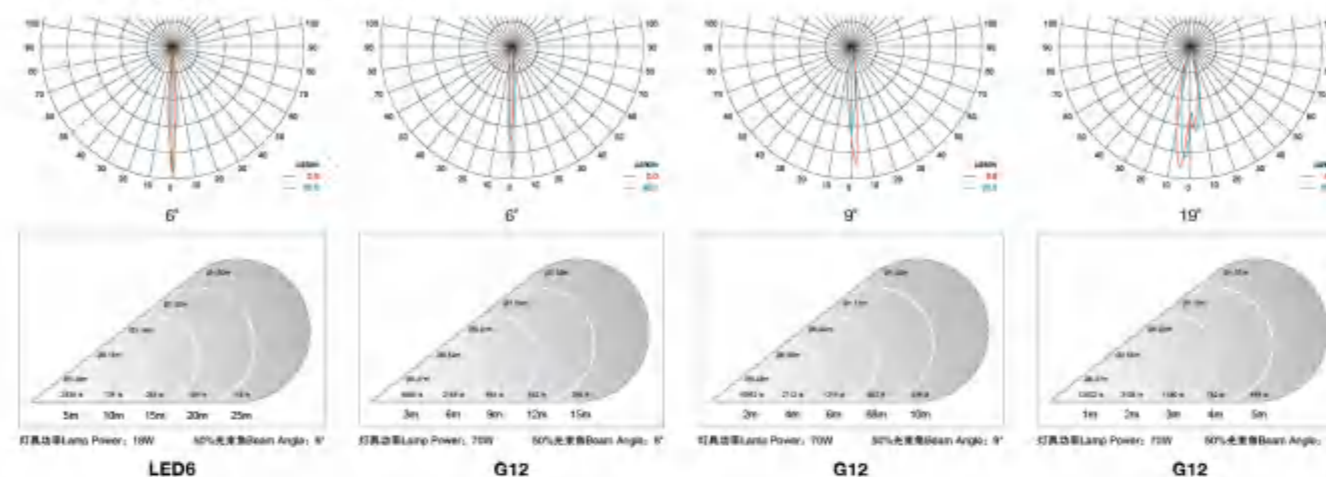

技术参数 Specification

类别	Product Code	参数 Parameter	参数 Parameter
额定功率	Rated Power	18W	70W
光源 / 数量	Light Source / Quantity	LED / 6pcs	G12 / 1pcs
输入电压	Input Voltage	DC 24V / AC 220V	AC 220V
色温	Color Temperature	3000K / 4000K / 5700K / RGB	3000K / 4200K
50%光束角	50% Beam Angle	6°	6° 9° 19°
控制方式	Control Mode	ON-OFF / DMX512	ON-OFF
使用寿命	Life	>30000H	>8000H
防护等级	Protection Grade	IP 65	IP 65
工作环境温度	Temperature of Working Condition	-25°C~50°C	-25°C~50°C
灯具净重	Net Weight	4.6kg	4.5kg
中包规格	Package Specification	A: 350x340x220mm	A: 350x340x220mm
外箱规格 / 数量	Outside Box Specifications / Quantity	A: 370x360x470mm / 2pcs	A: 370x360x470mm / 2pcs



颜色选择 Color Selection

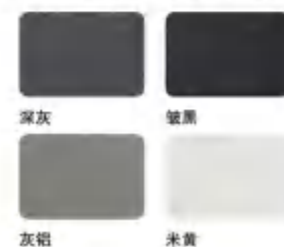

产品尺寸 Product Size

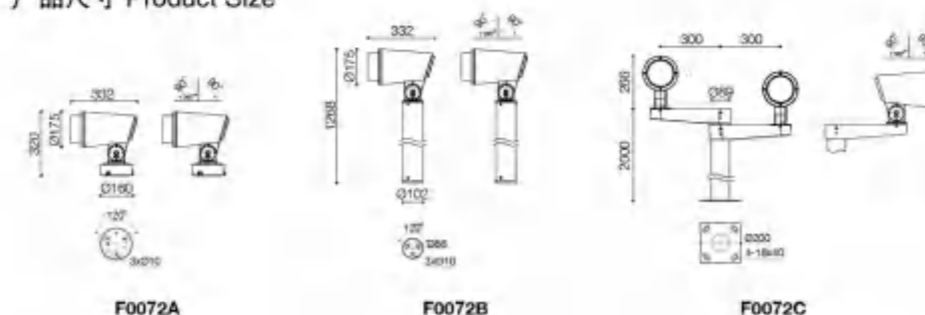

P0001 Series

专利号 Num: 201230154184.9
201230154188.7



适用场合

主要应用于楼宇、桥梁、河道等亮化工程。

The Application of Occasions

Suitable places: Buildings, Bridges, Rivers and Other lighting.

产品特点说明

1. 灯体主体部分采用高压压铸铝，表面双层静电喷塑处理，防腐性、抗老化，延长使用寿命。
2. 透光罩采用进口PC材料，更有效的提高了光的透射率。
3. 采用光学PC罩二次配光。
4. 采用高效率、高稳定性恒流驱动电源，保证了光源的稳定工作，降低光衰，延长使用寿命。
5. 灯体表面设计了散热片更有利于通风，增加散热面积，迅速散热，升华了灯具的整体美观程度，同时有利于去雨雪和灰尘，提高了灯具的自洁能力。
6. 控制方式可多种选择：单色、RGB内控、外控。
7. 采用硅橡胶密封结构设计，有效保证了防护等级IP65。



整体压铸散热灯体，提高散热效果。
Aluminium die-cast heat dissipation body,
increase heat dissipation efficiency.



钣金安装支架，便于安装。
Metal plate mounting bracket, convenient for
installation.

Product Description

1. High pressure Aluminium die-cast housing, coated with outdoor used powder, double anti-corrosion to extend service life.
2. Imported PC diffuser, effectively improve the transmission rate of the light.
3. Scientific secondary optical lens design.
4. High efficiency constant current driver, ensure the light source is maximum used.
5. Heat sink design on light body surface, increase the efficiency of heat-dissipation.
6. Control Mode: Monochrome control; RGB Inner control; RGB External control.
7. Using silicone rubber leakproof structure design to ensure the high level of IP rating (IP:65).

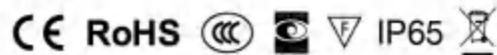

配光曲线 Light Distribution Curve

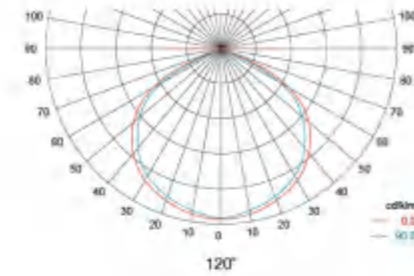

等照度图 Illumination Map

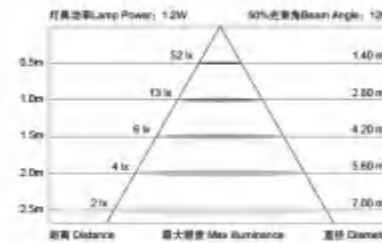

技术参数 Specification

类别	Product Code	参数 Parameter
额定功率	Rated Power	1.2W
光源 / 数量	LED Quantity	LED / 6pcs
输入电压	Input Voltage	DC 24V
色温	Color Temperature	3000K / 4000K / 5700K / RGB
50%光束角	50% Beam Angle	120°
控制方式	Control Mode	ON-OFF / DMX512
使用寿命	Life	>30000H
防护等级	Protection Grade	IP 65
工作环境温度	Temperature of Working Condition	-25°C~50°C
灯具净重	Net Weight	0.2kg
中包规格	Package Specification	90x90x60mm
外包装规格 / 数量	Outside Box Specifications / Quantity	470x200x330mm / 50pcs

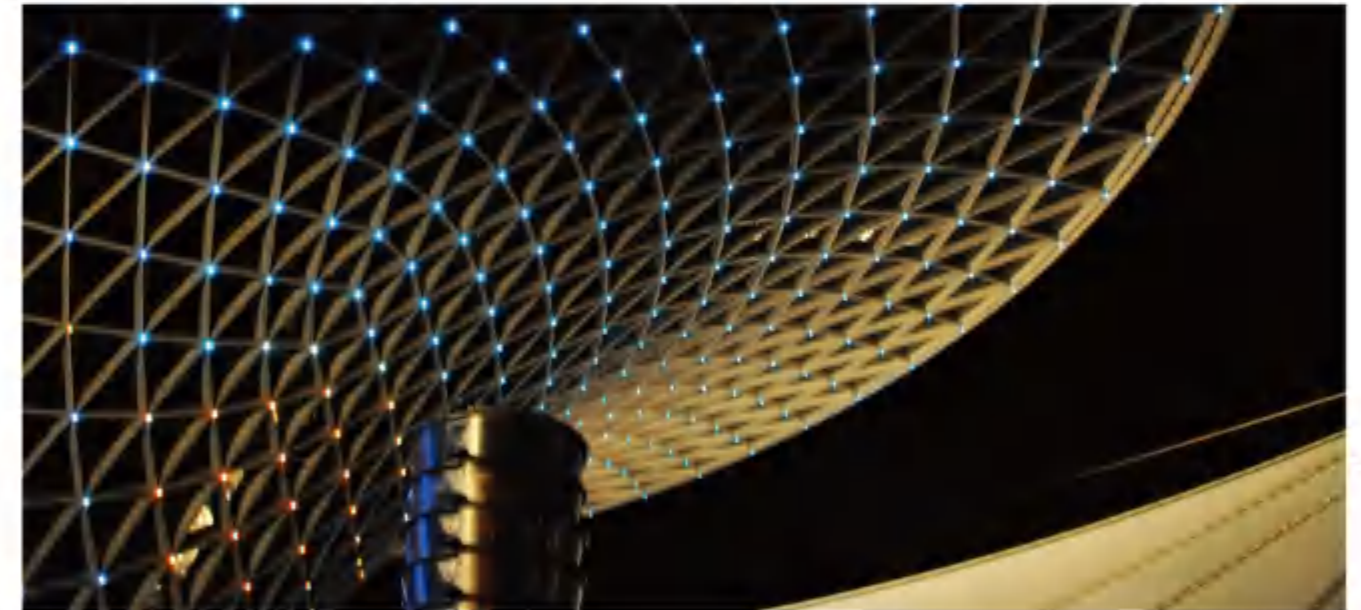

颜色选择 Color Selection

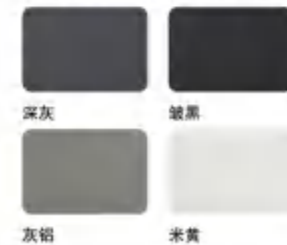

产品尺寸 Product Size

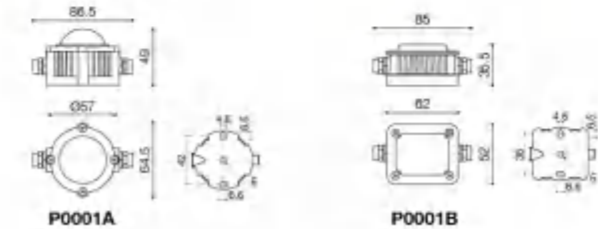

P0002 Series

专利号 Num: 201230619050.X
201230618772.3



适用场合

主要应用于楼宇、桥梁、河道等亮化工程。

The Application of Occasions

Suitable places: Buildings, Bridges, Rivers and Other lighting.

产品特点说明

1. 灯体主体部分采用高压压铸铝，表面双层静电喷塑处理，防腐性、抗老化，延长使用寿命。
2. 透光罩采用进口PC材料，更有效的提高了光的透射率。
3. 采用光学PC罩二次配光。
4. 采用高效率、高稳定性恒流驱动电源，保证了光源的稳定工作，降低光衰，延长使用寿命。
5. 灯体表面设计了散热片更有利于通风，增加散热面积，迅速散热，升华了灯具的整体美观程度，同时有利于去雨雪和灰尘，提高了灯具的自洁能力。
6. 控制方式可多种选择：单色、RGB内控、外控。
7. 采用硅橡胶密封结构设计，有效保证了防护等级IP65。

Product Description

1. High pressure Aluminium die-cast housing, coated with outdoor used powder, double anti-corrosion to extend service life.
2. Imported PC diffuser, effectively improve the transmission rate of the light.
3. Scientific secondary optical lens design.
4. High efficiency constant current driver, ensure the light source is maximum used.
5. Heat sink design on light body surface, increase the efficiency of heat-dissipation.
6. Control Mode: Monochrome control; RGB inner control; RGB External control.
7. Using silicone rubber leakproof structure design to ensure the high level of IP rating (IP:65).



整体压铸散热灯体，提高散热效果。
Aluminium die-cast heat dissipation body,
increase heat dissipation efficiency.



钣金安装支架，便于安装。
Metal plate mounting bracket, convenient for
installation.

CE RoHS CCC IP65

配光曲线 Light Distribution Curve

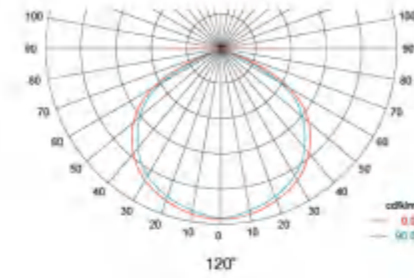

等照度图 Illumination Map

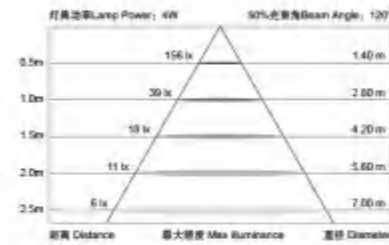

技术参数 Specification

类别	Product Code	参数 Parameter
额定功率	Rated Power	4W
光源 / 数量	LED Quantity	LED / 18pcs
输入电压	Input Voltage	DC 24V
色温	Color Temperature	3000K / 4000K / 5700K / RGB
50%光束角	50% Beam Angle	120°
控制方式	Control Mode	ON-OFF / DMX512
使用寿命	Life	>30000H
防护等级	Protection Grade	IP 65
工作环境温度	Temperature of Working Condition	-25°C~50°C
灯具净重	Net Weight	0.3kg
中包规格	Package Specification	120x120x70mm
外包装规格 / 数量	Outside Box Specifications / Quantity	500x260x380mm / 40pcs



颜色选择 Color Selection

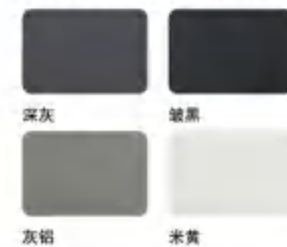

产品尺寸 Product Size

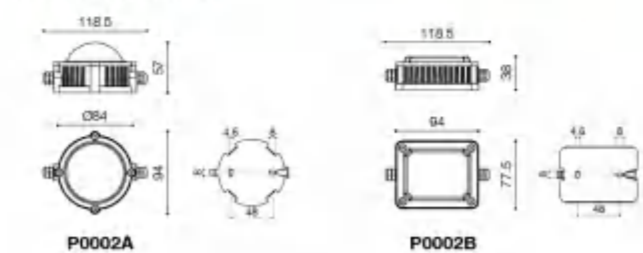

P0003A

专利设计 DESIGN PATENT



乳白PC罩, 提高光线均匀度。
Opal PC diffuser, increase the uniformity of light.



整体压铸散热灯体, 提高散热效果。
Aluminium die-cast heat dissipation body, increase heat dissipation efficiency.



钣金安装支架, 便于安装。
Metal plate mounting bracket, convenient for installation.



特质不锈钢防水接头, 保证防水性能。
Stainless steel water-proof joint to ensure waterproofness.

适用场合

主要应用于楼宇、桥梁、河道等亮化工程。

The Application of Occasions

Suitable places: Buildings, Bridges, Rivers and Other lighting.

产品特点说明

1. 灯体主体部分采用高压压铸铝, 表面双层静电喷塑处理, 防腐性、抗老化, 延长使用寿命。
2. 透光罩采用进口PC材料, 更有效的提高了光的透射率。
3. 采用光学PC罩二次配光。
4. 采用高效率、高稳定性恒流驱动电源, 保证了光源的稳定工作, 降低光衰, 延长使用寿命。
5. 灯体表面设计了散热片更有利于通风, 增加散热面积, 迅速散热, 升华了灯具的整体美观程度, 同时有利于去雨雪和灰尘, 提高了灯具的自治能力。
6. 控制方式可多种选择: 单色、RGB内控、外控。
7. 采用硅橡胶密封结构设计, 有效保证了防护等级IP65。

Product Description

1. High pressure Aluminium die-cast housing, coated with outdoor used powder, double anti-corrosion to extend service life.
2. Imported PC diffuser, effectively improve the transmission rate of the light.
3. Scientific secondary optical lens design.
4. High efficiency constant current driver, ensure the light source is maximum used.
5. Heat sink design on light body surface, increase the efficiency of heat-dissipation.
6. Control Mode: Monochrome control; RGB Inner control; RGB External control.
7. Using silicone rubber leakproof structure design to ensure the high level of IP rating (IP:65).

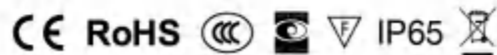

配光曲线 Light Distribution Curve

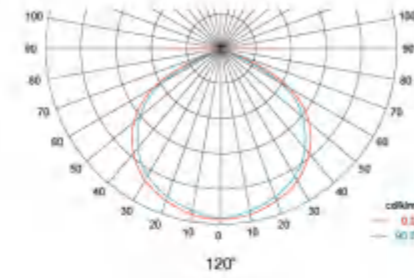

等照度图 Illumination Map

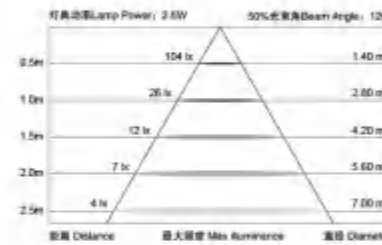

技术参数 Specification

类别	Product Code	参 数 Parameter
额定功率	Rated Power	2.5W
光源 / 数量	LED Quantity	LED / 12pcs
输入电压	Input Voltage	DC 24V
色温	Color Temperature	3000K / 4000K / 5700K / RGB
50%光束角	50% Beam Angle	120°
控制方式	Control Mode	ON-OFF / DMX512
使用寿命	Life	>30000H
防护等级	Protection Grade	IP 65
工作环境温度	Temperature of Working Condition	-25°C~50°C
灯具净重	Net Weight	0.2kg
中包规格	Package Specification	130x130x70mm
外包装规格 / 数量	Outside Box Specifications / Quantity	410x410x310mm / 36pcs



颜色选择 Color Selection

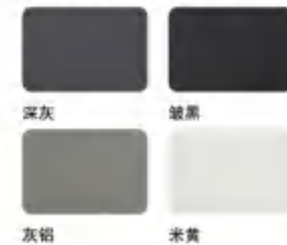

产品尺寸 Product Size

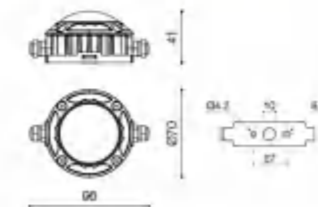

P0004A

专利设计 DESIGN PATENT



乳白PC罩, 提高光线均匀度。
Opal PC diffuser, increase the uniformity of light.



整体压铸散热灯体, 提高散热效果。
Aluminium die-cast heat dissipation body, increase heat dissipation efficiency.



钣金安装支架, 便于安装。
Metal plate mounting bracket, convenient for installation.



特质不锈钢防水接头, 保证防水性能。
Stainless steel water-proof joint to ensure waterproofness.

适用场合

主要应用于楼宇、桥梁、河道等亮化工程。

The Application of Occasions

Suitable places: Buildings, Bridges, Rivers and Other lighting.

产品特点说明

1. 灯体主体部分采用高压压铸铝, 表面双层静电喷塑处理, 防腐性、抗老化, 延长使用寿命。
2. 透光罩采用进口PC材料, 更有效的提高了光的透射率。
3. 采用光学PC罩二次配光。
4. 采用高效率、高稳定性恒流驱动电源, 保证了光源的稳定工作, 降低光衰, 延长使用寿命。
5. 灯体表面设计了散热片更有利于通风, 增加散热面积, 迅速散热, 升华了灯具的整体美观程度, 同时有利于去雨雪和灰尘, 提高了灯具的自洁能力。
6. 控制方式可多种选择: 单色、RGB内控、外控。
7. 采用硅橡胶密封结构设计, 有效保证了防护等级IP65。

Product Description

1. High pressure Aluminium die-cast housing, coated with outdoor used powder, double anti-corrosion to extend service life.
2. Imported PC diffuser, effectively improve the transmission rate of the light.
3. Scientific secondary optical lens design.
4. High efficiency constant current driver, ensure the light source is maximum used.
5. Heat sink design on light body surface, increase the efficiency of heat-dissipation.
6. Control Mode: Monochrome control; RGB Inner control; RGB External control.
7. Using silicone rubber leakproof structure design to ensure the high level of IP rating (IP:65).



配光曲线 Light Distribution Curve

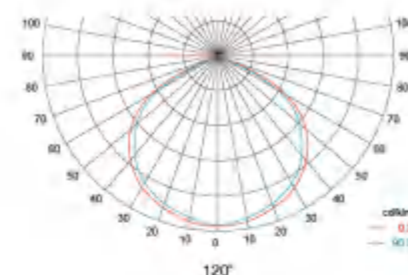

等照度图 Illumination Map

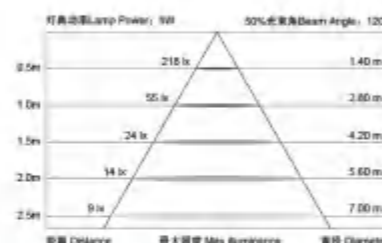

技术参数 Specification

类别	Product Code	参 数 Parameter
额定功率	Rated Power	5W
光源 / 数量	LED Quantity	LED / 24pcs
输入电压	Input Voltage	DC 24V
色温	Color Temperature	3000K / 4000K / 5700K / RGB
50%光束角	50% Beam Angle	120°
控制方式	Control Mode	ON-OFF / DMX512
使用寿命	Life	>30000H
防护等级	Protection Grade	IP 65
工作环境温度	Temperature of Working Condition	-25°C~50°C
灯具净重	Net Weight	0.4kg
中包规格	Package Specification	170x170x80mm
外箱规格 / 数量	Outside Box Specifications / Quantity	530x360x330mm / 24pcs



颜色选择 Color Selection

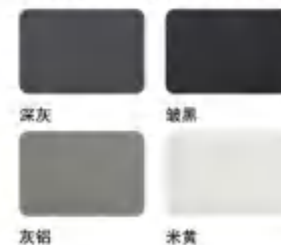

产品尺寸 Product Size

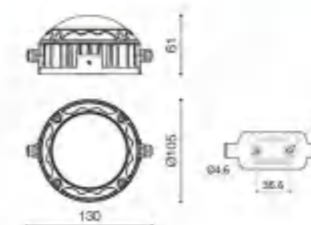

P0007

专利设计 DESIGN PATENT



进口透明PC罩透光。
Imported transparent PC cover light.



炫彩装饰片。
Colorful decorative film.



钢丝绳安装。
Wire rope installation.



安装卡扣。
Mounting clip.

适用场合

主要应用于楼宇、桥梁、河道等亮化工程。

The Application of Occasions

Suitable places: Buildings, Bridges, Rivers and Other lighting.

产品特点说明

1. 主体采用进口PC材质，一次注塑成型。
2. 配套图案装饰面盖，颜色可选，可组合图案，增强白天视觉感。
3. 安装卡扣支架，配合钢丝绳安装，便于安装。
4. 一体式光源及系统，使得灯具微小，便于隐藏。
5. 融入DMX512外控，可实现视频等各种亮化效果。
6. 整体灌胶处理，有效保证防护等级。

Product Description

1. The main use of imported PC material, a plastic injection molding.
2. Decorative pattern decorative cover, color can be combined pattern, enhance the visual sense of the day.
3. Install buckle bracket, with wire rope installation, easy to install.
4. Integrated light source and system, making the lamp small, easy to hide.
5. Into the DMX512 control, can realize video and other lighting effects.
6. The whole pouring glue treatment, effective protection level.

CE RoHS CCC IP65

配光曲线 Light Distribution Curve

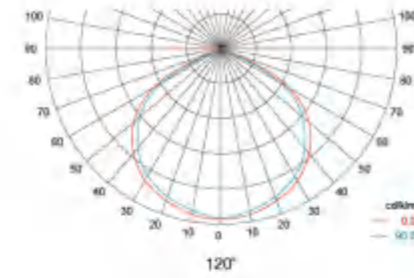

等照度图 Illumination Map

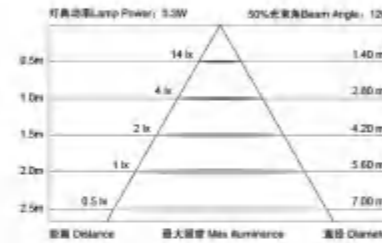

技术参数 Specification

类别	Product Code	参数 Parameter
额定功率	Rated Power	0.3W
光源 / 数量	LED Quantity	LED / 1pcs
输入电压	Input Voltage	DC 5V
色温	Color Temperature	3000K / 4000K / 5700K / RGB
50%光束角	50% Beam Angle	120°
控制方式	Control Mode	ON-OFF / DMX512
使用寿命	Life	>30000H
防护等级	Protection Grade	IP 65
工作环境温度	Temperature of Working Condition	-25°C-50°C
灯具净重	Net Weight	10g
中包规格	Package Specification	40灯 / 串 / 袋
外包装规格 / 数量	Outside Box Specifications / Quantity	600x400x350mm / 1000pcs



产品尺寸 Product Size

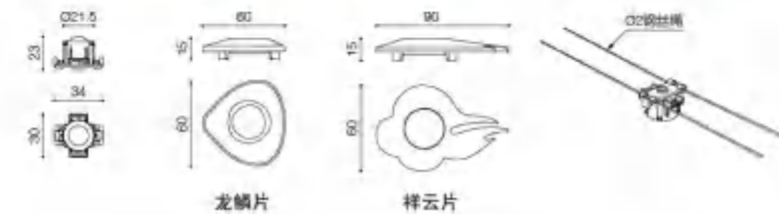

P0009

专利设计 DESIGN PATENT



适用场合

主要应用于楼宇、桥梁、河道等亮化工程。

The Application of Occasions

Suitable places: Buildings, Bridges, Rivers and Other lighting.

产品特点说明

1. 主体采用进口PC材质，一次注塑成型。
2. 卡扣式安装，安装及线槽铝材配套使用，便于安装。
3. 一体式光源及系统，使得灯具微小，便于隐藏。
4. 融入DMX512外控，可实现视频等各种亮化效果。
5. 整体灌胶处理，有效保证防护等级。

Product Description

1. The main use of imported PC material, a plastic injection molding;
2. Buckle type installation, installation and aluminum wire slot matching use, easy to install;
3. Integrated light source and system, making the lamp small, easy to hide;
4. Into the DMX512 control, can realize video and other lighting effects;
5. The whole pouring glue treatment, effective protection level;

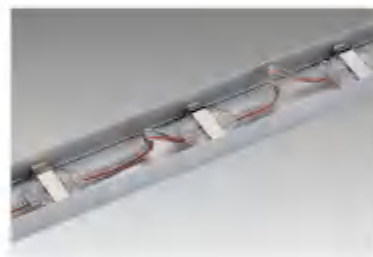

铝合金型材安装铝槽。
Aluminum alloy profile installation aluminum trough.



弹簧卡有效固定。
Spring card fixing.



配光曲线 Light Distribution Curve

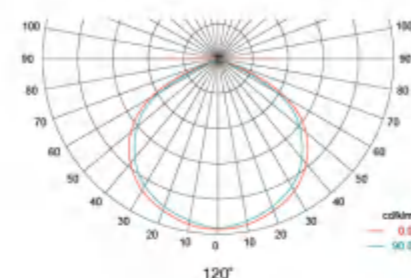

等照度图 Illumination Map



技术参数 Specification

类别	Product Code	参数 Parameter
额定功率	Rated Power	0.7W
光源 / 数量	LED Quantity	LED / 3pcs
输入电压	Input Voltage	DC 12V
色温	Color Temperature	3000K / 4000K / 5700K / RGB
50%光束角	50% Beam Angle	120°
控制方式	Control Mode	ON-OFF / DMX512
使用寿命	Life	>30000H
防护等级	Protection Grade	IP 65
工作环境温度	Temperature of Working Condition	-25°C-50°C
灯具净重	Net Weight	15g
中包规格	Package Specification	40灯 / 串 / 袋
外箱规格 / 数量	Outside Box Specifications / Quantity	600x400x350mm / 800pcs

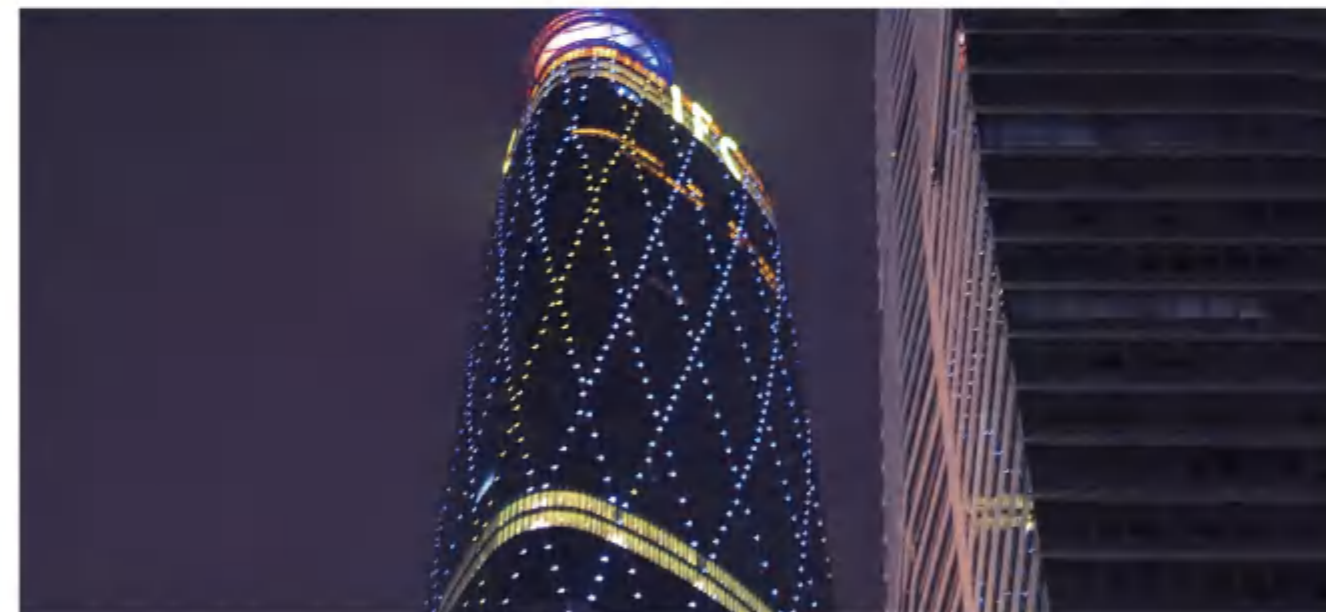

颜色选择 Color Selection

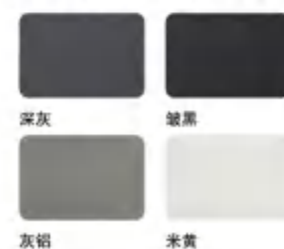

产品尺寸 Product Size

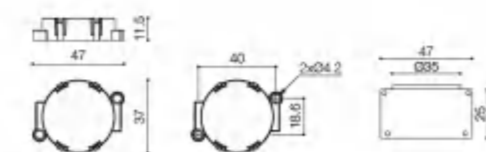

P0010

专利设计 DESIGN PATENT



适用场合

主要应用于楼宇、桥梁、河道等亮化工程。

The Application of Occasions

Suitable places: Buildings, Bridges, Rivers and Other lighting.

产品特点说明

1. 主体采用进口PC材质，一次注塑成型。
2. 卡扣式安装，安装及线槽铝材配套使用，便于安装。
3. 一体式光源及系统，使得灯具微小，便于隐藏。
4. 融入DMX512外控，可实现视频等各种亮化效果。
5. 整体灌胶处理，有效保证防护等级。

Product Description

1. The main use of imported PC material, a plastic injection molding;
2. Buckle type installation, installation and aluminum wire slot matching use, easy to install;
3. Integrated light source and system, making the lamp small, easy to hide;
4. Into the DMX512 control, can realize video and other lighting effects;
5. The whole pouring glue treatment, effective protection level;



铝合金型材安装铝槽。
Aluminum alloy profile installation aluminum trough.



整灯轻薄。
Whole lamp light.



配光曲线 Light Distribution Curve

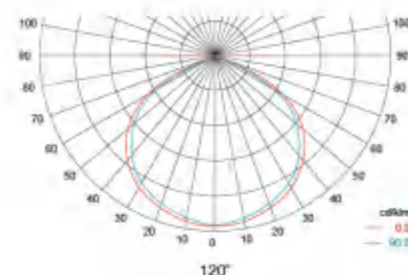

等照度图 Illumination Map



技术参数 Specification

类别	Product Code	参数 Parameter
额定功率	Rated Power	1.5W
光源 / 数量	LED Quantity	LED / 6pcs
输入电压	Input Voltage	DC 24V
色温	Color Temperature	3000K / 4000K / 5700K / RGB
50%光束角	50% Beam Angle	120°
控制方式	Control Mode	ON-OFF / DMX512
使用寿命	Life	>30000H
防护等级	Protection Grade	IP 65
工作环境温度	Temperature of Working Condition	-25°C-50°C
灯具净重	Net Weight	30g
中包规格	Package Specification	40灯 / 串 / 袋
外箱规格 / 数量	Outside Box Specifications / Quantity	600x400x350mm / 600pcs



颜色选择 Color Selection

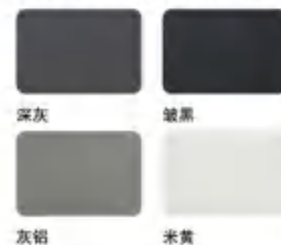

产品尺寸 Product Size

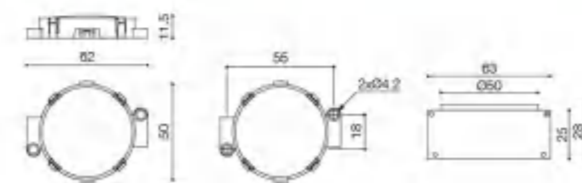

BT7307A

专利设计 DESIGN PATENT



BT7307B

专利设计 DESIGN PATENT



适用场合

主要应用于草坪、花园、公园、小区道路、步行街等。

The Application of Occasions

Suitable places: Lawn, Garden, Park, Path, Pedestrian, Precinct etc.

产品特点说明

1. 灯体主体部分采用不锈钢，表面采用电泳处理，防腐蚀、抗老化，延长使用寿命。
2. 透光罩采用钢化超白玻璃，更有效的提高了光的透射率。
3. 采用光学透镜二次配光，根据实际应用可选择透镜角度。
4. 采用高效率、高稳定性恒流驱动电源，保证了光源的稳定工作，降低光衰，延长使用寿命。
5. 安装采用塑料预埋件，安装简洁方便。
6. 采用硅橡胶密封结构设计，有效保证了防护等级IP67。

Product Description

1. Stainless steel body, the surface is electrophoresis coated with outdoor used clear lacquer, smooth, acid and alkali resistant, Aging resistant.
2. Ultrawhite tempered glass diffuser, effectively improve the transmission rate of light.
3. Scientific optical lens design, with different lens angle choice.
4. High efficiency constant current driver, ensure the light source is maximum used.
5. Plastic recessed housing included.
6. Using silicone rubber leakproof structure design to ensure the high level of IP rating (IP:67).



不锈钢弹簧片，便于安装。

Stainless steel spring, convenient for installation.



整体注塑预埋桶，便于安装维护。

Plastic recessed housing, convenient for installation and maintenance.



配光曲线 Light Distribution Curve

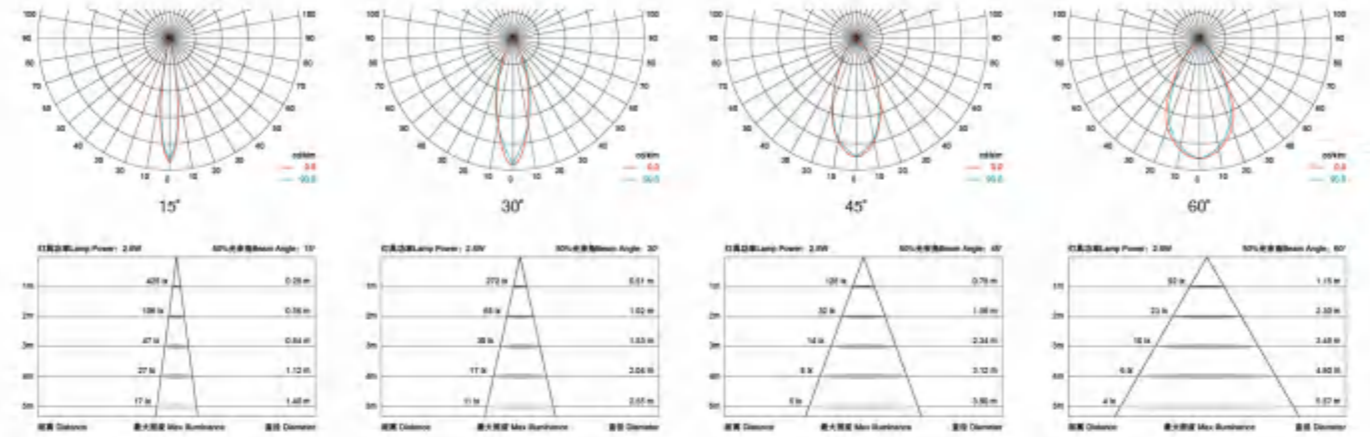

技术参数 Specification

类别	参数	类别	参数	类别	参数
额定功率 Rated Power	2.5W	光源 / 数量 LED Quantity	LED / 1pcs	输入电压 Input Voltage	DC 24V / AC 220V
色温 Color Temperature	3000K / 4000K / 5700K	50%光束角 50% Beam Angle	15° 30° 45° 60°	控制方式 Control Mode	ON-OFF
使用寿命 Life	>30000H	防护等级 Protection Grade	IP 67	工作环境温度 Temperature of Working Condition	-25°C-50°C
灯具净重 Net Weight	0.3kg	中包规格 Package Specification	100x100x100mm	外箱规格 / 数量 Outside Box Specifications / Quantity	420x320x320mm / 24pcs



材质 Material



304

316

产品尺寸 Product Size



开孔尺寸为Φ38

开孔示意图

开孔示意图

BT7307A

BT7307B

BT7025S

专利号 Num: 201230155472.6



二次光学透镜配光, 多种角度选择。
Scientific optical lens with different beam angle choice.

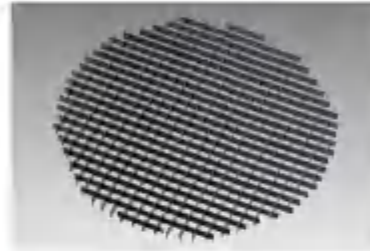

可选配蜂窝格栅防眩光罩。
Optional cellular anti glare grille mask.



敞开式散热片, 提高散热效果。
Open-type heat sink, improve heat dissipation efficiency.



整体注塑预埋桶, 便于安装维护。
Plastic recessed housing, convenient for installation and maintenance.

适用场合

主要应用于草坪、花园、公园、小区道路, 步行街等。

The Application of Occasions

Suitable places: Lawn, Garden, Park, Path, Pedestrian, Precinct etc.

产品特点说明

- 灯体主体部分采用高压压铸铝和不锈钢, 表面采用静电喷塑和电泳处理, 防腐蚀、抗老化, 延长使用寿命。
- 透光罩采用钢化超白玻璃, 更有效的提高了光的透射率。
- 采用光学透镜二次配光, 根据实际应用可选择透镜角度。
- 采用高效率、高稳定性恒流驱动电源, 保证了光源的稳定工作, 降低光衰, 延长使用寿命。
- 灯体表面设计了横纵向散热片更有利于通风, 增加散热面积, 迅速散热, 升华了灯具的整体美观程度。
- 独立的电源腔体设计, 有效的保证了电源的散热, 延长电源使用寿命。
- 安装采用塑料预埋件, 安装简洁方便。
- 采用硅橡胶密封结构设计, 有效保证了防护等级IP67。

Product Description

- Aluminium die-cast housing, stainless steel cover, double anti-corrosion to extend service life.
- Ultrawhite tempered glass diffuser, effectively improve the transmission rate of light.
- Scientific optical lens design, with different lens angle choice.
- High efficiency constant current driver, ensure the light source is maximum used.
- Lateral and axial heat sink design on light body surface, increase the efficiency of heat-dissipation.
- Independent power supply recessed design, extend the power supply working life.
- Plastic recessed housing included.
- Using silicone rubber leakproof structure design to ensure the high level of IP rating (IP:67).



配光曲线 Light Distribution Curve

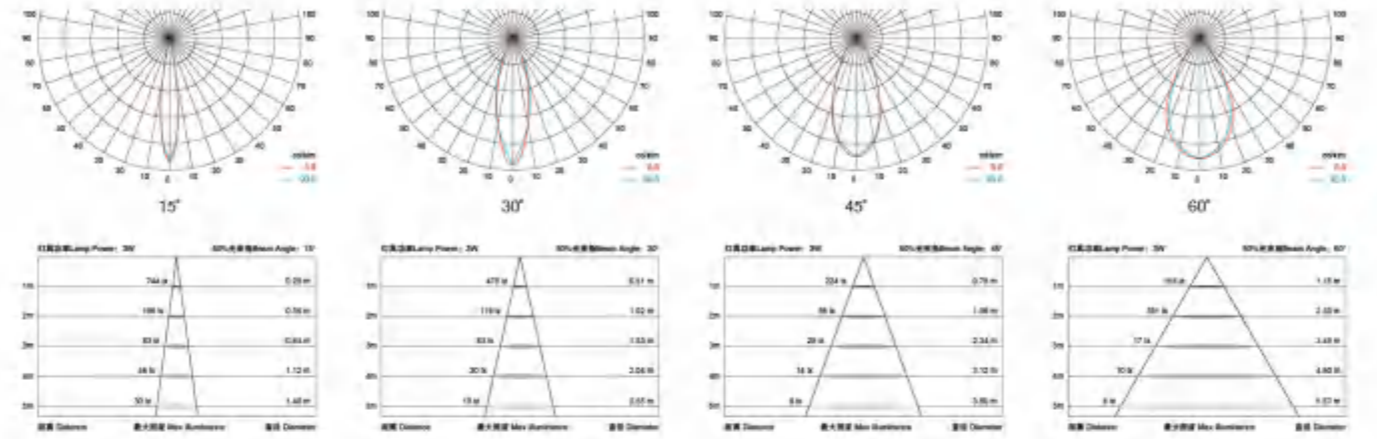

技术参数 Specification

类别	参数	类别	参数	类别	参数
额定功率 Rated Power	3W	光源 / 数量 LED Quantity	LED / 3pcs	输入电压 Input Voltage	DC 24V / AC 220V
色温 Color Temperature	3000K / 4000K / 5700K / RGB	50%光束角 50% Beam Angle	15° 30° 45° 60°	控制方式 Control Mode	ON-OFF / DMX512
使用寿命 Life	>30000H	防护等级 Protection Grade	IP 67	工作环境温度 Temperature of Working Condition	-25°C~50°C
灯具净重 Net Weight	0.7kg	中包规格 Package Specification	105x105x110mm	外箱规格 / 数量 Outside Box Specification / Quantity	450x340x230mm / 24pcs



材质 Material



产品尺寸 Product Size

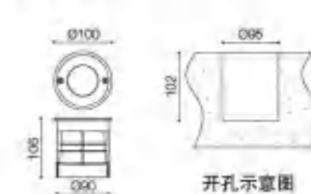

开孔示意图

BT7025B

专利号 Num: 201230155467.5



二次光学透镜配光, 多种角度选择。
Scientific optical lens with different beam angle choice.



可选配蜂窝格栅防眩光罩。
Optional cellular anti glare grille mask.



敞开式散热片, 提高散热效果。
Open-type heat sink, improve heat dissipation efficiency.



整体注塑预埋桶, 便于安装维护。
Plastic recessed housing, convenient for installation and maintenance.

适用场合

主要应用于草坪、花园、公园、小区道路, 步行街等。

The Application of Occasions

Suitable places: Lawn, Garden, Park, Path, Pedestrian, Precinct etc.

产品特点说明

- 灯体主体部分采用高压压铸铝和不锈钢, 表面采用静电喷塑和电泳处理, 防腐蚀、抗老化, 延长使用寿命。
- 透光罩采用钢化超白玻璃, 更有效的提高了光的透射率。
- 采用光学透镜二次配光, 根据实际应用可选择透镜角度。
- 采用高效率、高稳定性恒流驱动电源, 保证了光源的稳定工作, 降低光衰, 延长使用寿命。
- 灯体表面设计了横纵向散热片更有利于通风, 增加散热面积, 迅速散热, 升华了灯具的整体美观程度。
- 独立的电源腔体设计, 有效的保证了电源的散热, 延长电源使用寿命。
- 安装采用塑料预埋件, 安装简洁方便。
- 采用硅橡胶密封结构设计, 有效保证了防护等级IP67。

Product Description

- Aluminium die-cast housing, stainless steel cover, double anti-corrosion to extend service life.
- Ultrawhite tempered glass diffuser, effectively improve the transmission rate of light.
- Scientific optical lens design, with different lens angle choice.
- High efficiency constant current driver, ensure the light source is maximum used.
- Lateral and axial heat sink design on light body surface, increase the efficiency of heat-dissipation.
- Independent power supply recessed design, extend the power supply working life.
- Plastic recessed housing included.
- Using silicone rubber leakproof structure design to ensure the high level of IP rating (IP:67).



配光曲线 Light Distribution Curve

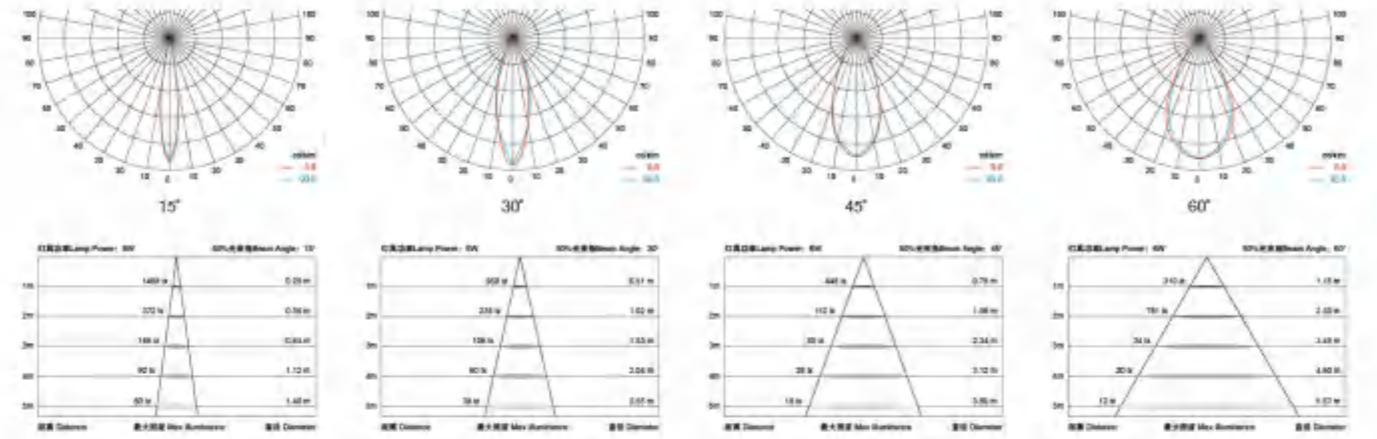

技术参数 Specification

类别	参数	类别	参数	类别	参数
额定功率 Rated Power	6W	光源 / 数量 LED Quantity	LED / 6pcs	输入电压 Input Voltage	DC 24V / AC 220V
色温 Color Temperature	3000K / 4000K / 5700K / RGB	50°光束角 50° Beam Angle	15° 30° 45° 60°	控制方式 Control Mode	ON-OFF / DMX512
使用寿命 Life	>30000H	防护等级 Protection Grade	IP 67	工作环境温度 Temperature of Working Condition	-25°C~50°C
灯具净重 Net Weight	1.4kg	中包规格 Package Specification	165x165x115mm	外箱规格 / 数量 Outside Box Specification / Quantity	500x340x240mm / 12pcs



材质 Material



产品尺寸 Product Size

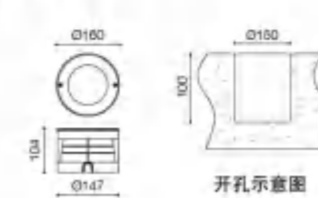

BT7025C

专利号 Num: 201230155487.2



二次光学透镜配光, 多种角度选择。
Scientific optical lens with different beam angle choice.



可选配蜂窝格栅防眩光罩。
Optional cellular anti glare grille mask.



敞开式散热片, 提高散热效果。
Open-type heat sink, improve heat-dissipation efficiency.



整体注塑预埋桶, 便于安装维护。
Plastic recessed housing, convenient for installation and maintainance.

适用场合

主要应用于草坪、花园、公园、小区道路, 步行街等。

The Application of Occasions

Suitable places: Lawn, Garden, Park, Path, Pedestrian, Precinct etc.

产品特点说明

- 灯体主体部分采用高压压铸铝和不锈钢, 表面采用静电喷塑和电泳处理, 防腐蚀、抗老化, 延长使用寿命。
- 透光罩采用钢化超白玻璃, 更有效的提高了光的透射率。
- 采用光学透镜二次配光, 根据实际应用可选择透镜角度。
- 采用高效率、高稳定性恒流驱动电源, 保证了光源的稳定工作, 降低光衰, 延长使用寿命。
- 灯体表面设计了横纵向散热片更有利于通风, 增加散热面积, 迅速散热, 升华了灯具的整体美观程度。
- 独立的电源腔体设计, 有效的保证了电源的散热, 延长电源使用寿命。
- 安装采用塑料预埋件, 安装简洁方便。
- 采用硅橡胶密封结构设计, 有效保证了防护等级IP67。

Product Description

- Aluminium die-cast housing, stainless steel cover, double anti-corrosion to extend service life.
- Ultrawhite tempered glass diffuser, effectively improve the transmission rate of light.
- Scientific optical lens design, with different lens angle choice.
- High efficiency constant current driver, ensure the light source is maximum used.
- Lateral and axial heat sink design on light body surface, increase the efficiency of heat-dissipation.
- Independent power supply recessed design, extend the power supply working life.
- Plastic recessed housing included.
- Using silicone rubber leakproof structure design to ensure the high level of IP rating (IP:67).



配光曲线 Light Distribution Curve

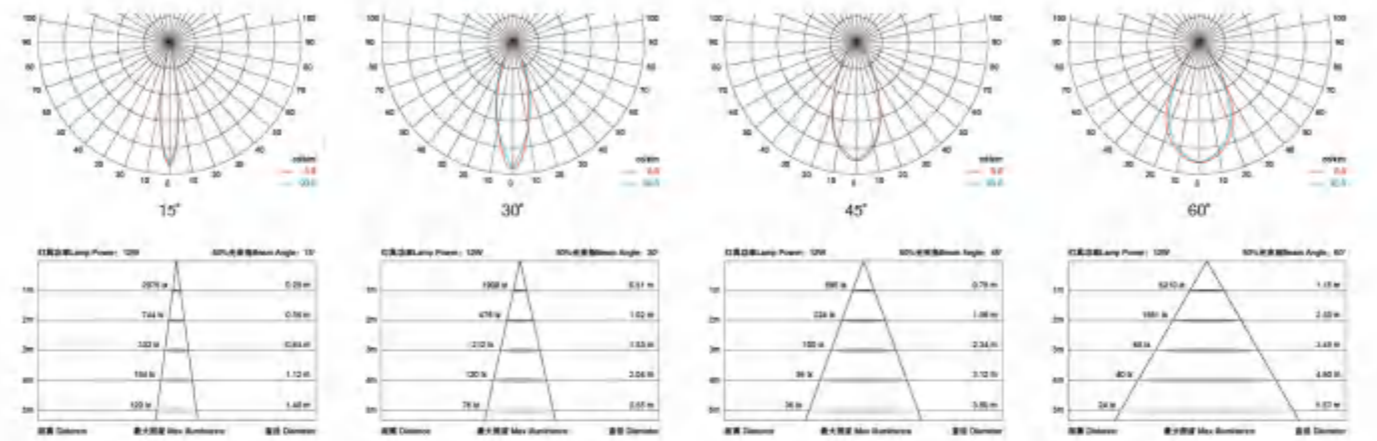

技术参数 Specification

变更项目	参数	变更项目	参数	变更项目	参数
额定功率 Rated Power	12W	光源 / 数量 LED Quantity	LED / 12pcs	输入电压 Input Voltage	DC 24V / AC 220V
色温 Color Temperature	3000K / 4000K / 5700K / RGB	50%光束角 50% Beam Angle	15° 30° 45° 60°	控制方式 Control Mode	ON-OFF / DMX512
使用寿命 Life	>30000H	防护等级 Protection Grade	IP 67	工作环境温度 Temperature of Working Condition	-25°C~50°C
灯具净重 Net Weight	1.5kg	中包规格 Package Specification	185x185x130mm	外箱规格 / 数量 Outside Box Specification / Quantity	380x380x270mm / 8pcs



材质 Material



产品尺寸 Product Size

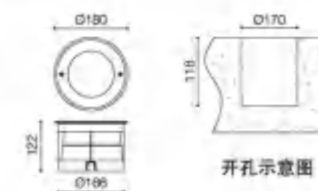

BT7025D

专利号 Num: 201230155581.8



二次光学透镜配光, 多种角度选择。
Scientific optical lens with different beam angle choice.

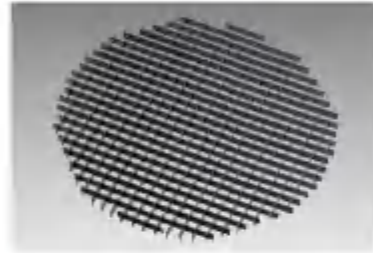

可选配蜂窝格栅防眩光罩。
Optional cellular anti glare grille mask.



敞开式散热片, 提高散热效果。
Open-type heat sink, improve heat dissipation efficiency.



整体注塑预埋桶, 便于安装维护。
Plastic recessed housing, convenient for installation and maintenance.

适用场合

主要应用于草坪、花园、公园、小区道路, 步行街等。

The Application of Occasions

Suitable places: Lawn, Garden, Park, Path, Pedestrian, Precinct etc.

产品特点说明

- 灯体主体部分采用高压压铸铝和不锈钢, 表面采用静电喷塑和电泳处理, 防腐蚀、抗老化, 延长使用寿命。
- 透光罩采用钢化超白玻璃, 更有效的提高了光的透射率。
- 采用光学透镜二次配光, 根据实际应用可选择透镜角度。
- 采用高效率、高稳定性恒流驱动电源, 保证了光源的稳定工作, 降低光衰, 延长使用寿命。
- 灯体表面设计了横纵向散热片更有利于通风, 增加散热面积, 迅速散热, 升华了灯具的整体美观程度。
- 独立的电源腔体设计, 有效的保证了电源的散热, 延长电源使用寿命。
- 安装采用塑料预埋件, 安装简洁方便。
- 采用硅橡胶密封结构设计, 有效保证了防护等级IP67。

Product Description

- Aluminium die-cast housing, stainless steel cover, double anti-corrosion to extend service life.
- Ultrawhite tempered glass diffuser, effectively improve the transmission rate of light.
- Scientific optical lens design, with different lens angle choice.
- High efficiency constant current driver, ensure the light source is maximum used.
- Lateral and axial heat sink design on light body surface, increase the efficiency of heat-dissipation.
- Independent power supply recessed design, extend the power supply working life.
- Plastic recessed housing included.
- Using silicone rubber leakproof structure design to ensure the high level of IP rating (IP:67).



配光曲线 Light Distribution Curve

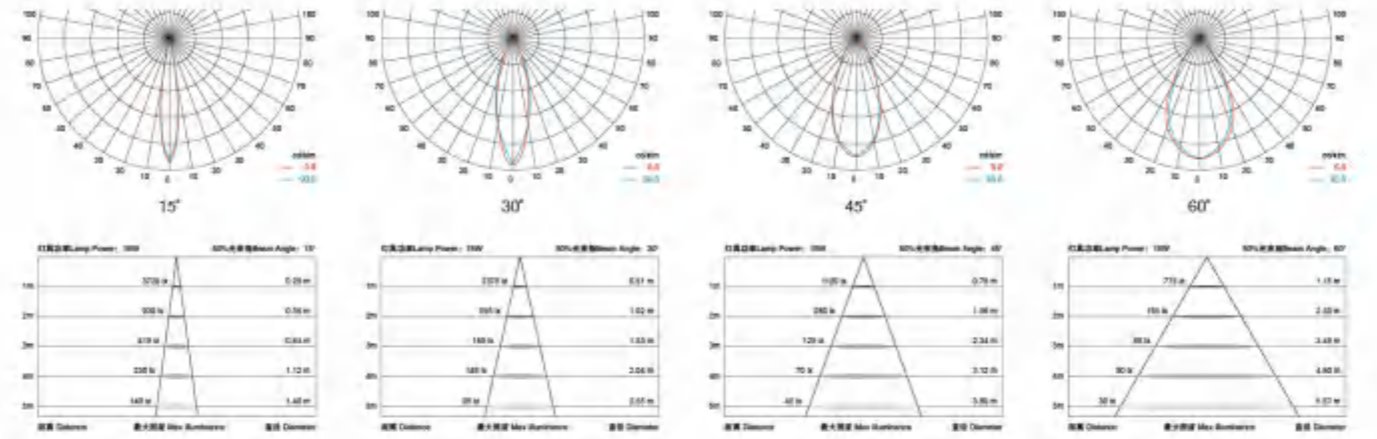

技术参数 Specification

类别	参数	类别	参数	类别	参数
额定功率 Rated Power	15W	光源 / 数量 LED Quantity	LED / 15pcs	输入电压 Input Voltage	DC 24V / AC 220V
色温 Color Temperature	3000K / 4000K / 5700K / RGB	50°光束角 50° Beam Angle	15° 30° 45° 60°	控制方式 Control Mode	ON-OFF / DMX512
使用寿命 Life	>30000H	防护等级 Protection Grade	IP 67	工作环境温度 Temperature of Working Condition	-25°C~50°C
灯具净重 Net Weight	2.2kg	中包规格 Package Specification	215x215x125mm	外箱规格 / 数量 Outside Box Specification / Quantity	440x440x250mm / 8pcs



材质 Material



产品尺寸 Product Size

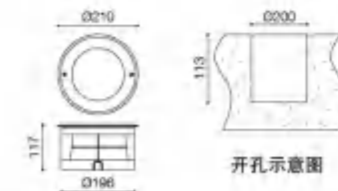

BT7025E

专利号 Num: 201230155490.4



二次光学透镜配光, 多种角度选择。
Scientific optical lens with different beam angle choice.

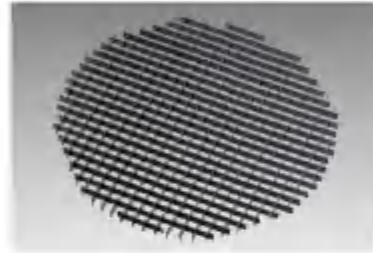

可选配蜂窝格栅防眩光罩。
Optional cellular anti glare grille mask.



敞开式散热片, 提高散热效果。
Open-type heat sink, improve heat dissipation efficiency.



整体注塑预埋桶, 便于安装维护。
Plastic recessed housing, convenient for installation and maintenance.

适用场合

主要应用于草坪、花园、公园、小区道路, 步行街等。

The Application of Occasions

Suitable places: Lawn, Garden, Park, Path, Pedestrian, Precinct etc.

产品特点说明

1. 灯体主体部分采用高压压铸铝和不锈钢, 表面采用静电喷塑和电泳处理, 防腐蚀、抗老化, 延长使用寿命。
2. 透光罩采用钢化超白玻璃, 更有效的提高了光的透射率。
3. 采用光学透镜二次配光, 根据实际应用可选择透镜角度。
4. 采用高效率、高稳定性恒流驱动电源, 保证了光源的稳定工作, 降低光衰, 延长使用寿命。
5. 灯体表面设计了纵向散热片更有利于通风, 增加散热面积, 迅速散热, 升华了灯具的整体美观程度。
6. 独立的电源腔体设计, 有效的保证了电源的散热, 延长电源使用寿命。
7. 安装采用塑料预埋件, 安装简洁方便。
8. 采用硅橡胶密封结构设计, 有效保证了防护等级IP67。

Product Description

1. Aluminium die-cast housing, stainless steel cover, double anti-corrosion to extend service life.
2. Ultrawhite tempered glass diffuser, effectively improve the transmission rate of light.
3. Scientific optical lens design, with different lens angle choice.
4. High efficiency constant current driver, ensure the light source is maximum used.
5. Lateral and axial heat sink design on light body surface, increase the efficiency of heat-dissipation.
6. Independent power supply recessed design, extend the power supply working life.
7. Plastic recessed housing included.
8. Using silicone rubber leakproof structure design to ensure the high level of IP rating (IP:67).



配光曲线 Light Distribution Curve

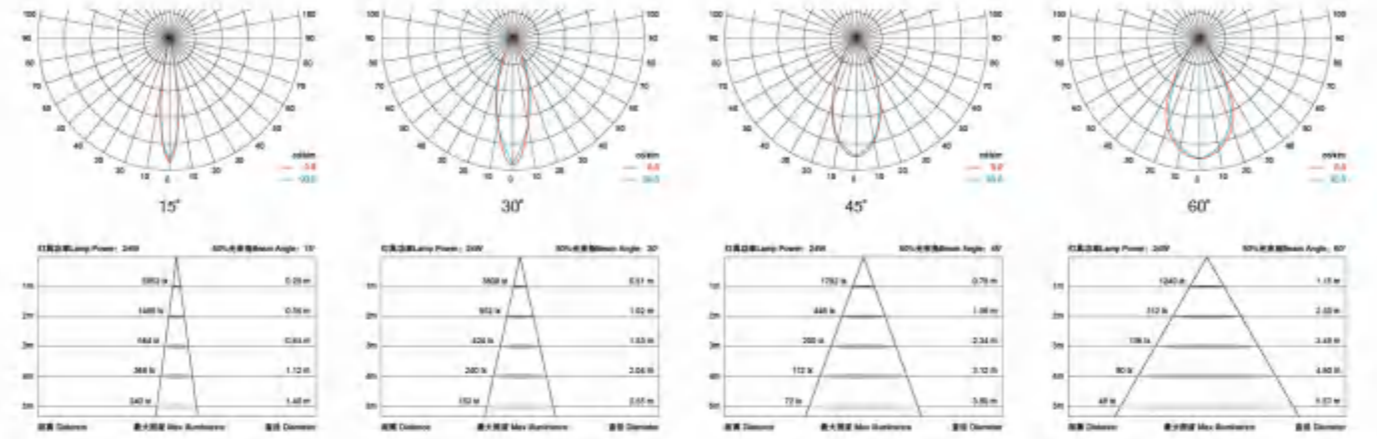

技术参数 Specification

说明 Description	参数 Parameter	说明 Description	参数 Parameter
额定功率 Rated Power	24W	光源 / 数量 LED Quantity	LED / 24pcs
色温 Color Temperature	3000K / 4000K / 5700K / RGB	50°光束角 50% Beam Angle	15° 30° 45° 60°
使用寿命 Life	>30000H	防护等级 Protection Grade	IP 67
灯具净重 Net Weight	3.2kg	中包规格 Package Specification	265x265x125mm
		输入电压 Input Voltage	DC 24V / AC 220V
		控制方式 Control Mode	ON-OFF / DMX512
		工作环境温度 Temperature of Working Condition	-25°C~50°C
		外箱规格 / 数量 Outside Box Specification / Quantity	550x280x260mm / 4pcs

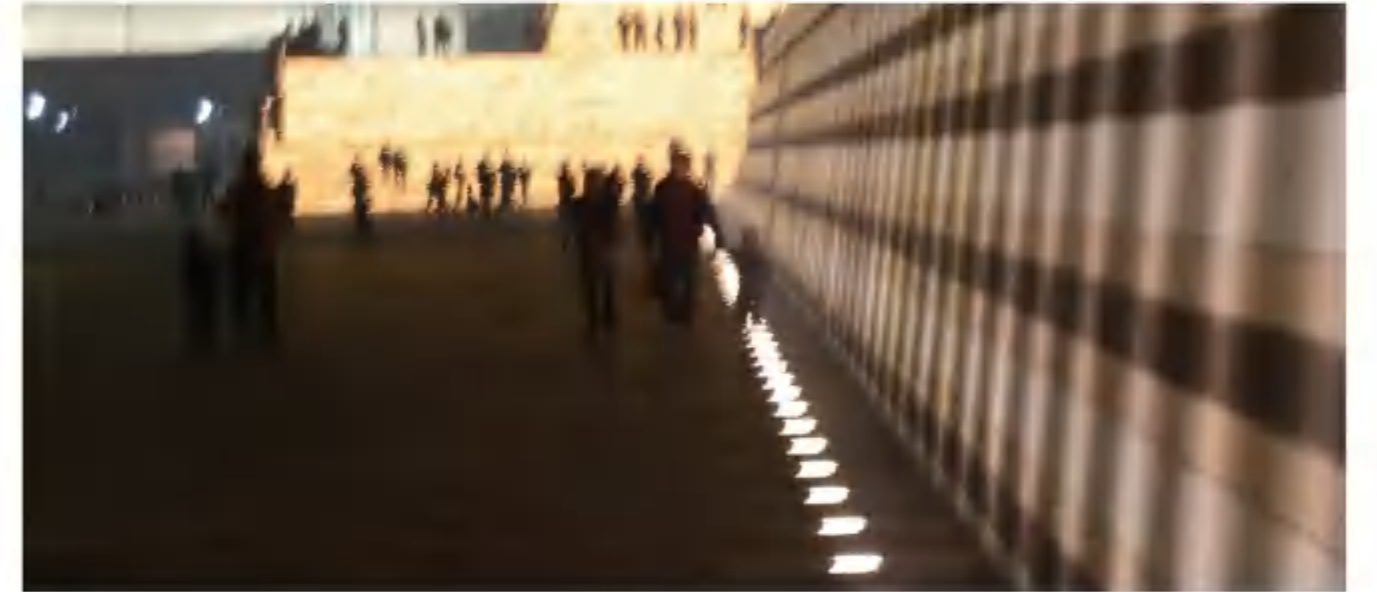

材质 Material



产品尺寸 Product Size

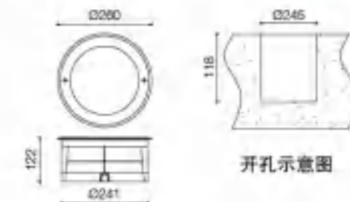

BT7025F

专利设计 DESIGN PATENT



二次光学透镜配光, 多种角度选择。
Scientific optical lens with different beam angle choice.



可选配蜂窝格栅防眩光罩。
Optional cellular anti glare grille mask.



敞开式散热片, 提高散热效果。
Open-type heat sink, improve heat-dissipation efficiency.



整体注塑预埋桶, 便于安装维护。
Plastic recessed housing, convenient for installation and maintainance.

适用场合

主要应用于草坪、花园、公园、小区道路, 步行街等。

The Application of Occasions

Suitable places: Lawn, Garden, Park, Path, Pedestrian, Precinct etc.

产品特点说明

- 灯体主体部分采用高压压铸铝和不锈钢, 表面采用静电喷塑和电泳处理, 防腐蚀、抗老化, 延长使用寿命。
- 透光罩采用钢化超白玻璃, 更有效的提高了光的透射率。
- 采用光学透镜二次配光, 根据实际应用可选择透镜角度。
- 采用高效率、高稳定性恒流驱动电源, 保证了光源的稳定工作, 降低光衰, 延长使用寿命。
- 灯体表面设计了横纵向散热片更有利于通风, 增加散热面积, 迅速散热, 升华了灯具的整体美观程度。
- 独立的电源腔体设计, 有效的保证了电源的散热, 延长电源使用寿命。
- 安装采用塑料预埋件, 安装简洁方便。
- 采用硅橡胶密封结构设计, 有效保证了防护等级IP67。

Product Description

- Aluminium die-cast housing, stainless steel cover, double anti-corrosion to extend service life.
- Ultrawhite tempered glass diffuser, effectively improve the transmission rate of light.
- Scientific optical lens design, with different lens angle choice.
- High efficiency constant current driver, ensure the light source is maximum used.
- Lateral and axial heat sink design on light body surface, increase the efficiency of heat-dissipation.
- Independent power supply recessed design, extend the power supply working life.
- Plastic recessed housing included.
- Using silicone rubber leakproof structure design to ensure the high level of IP rating (IP:67).



配光曲线 Light Distribution Curve

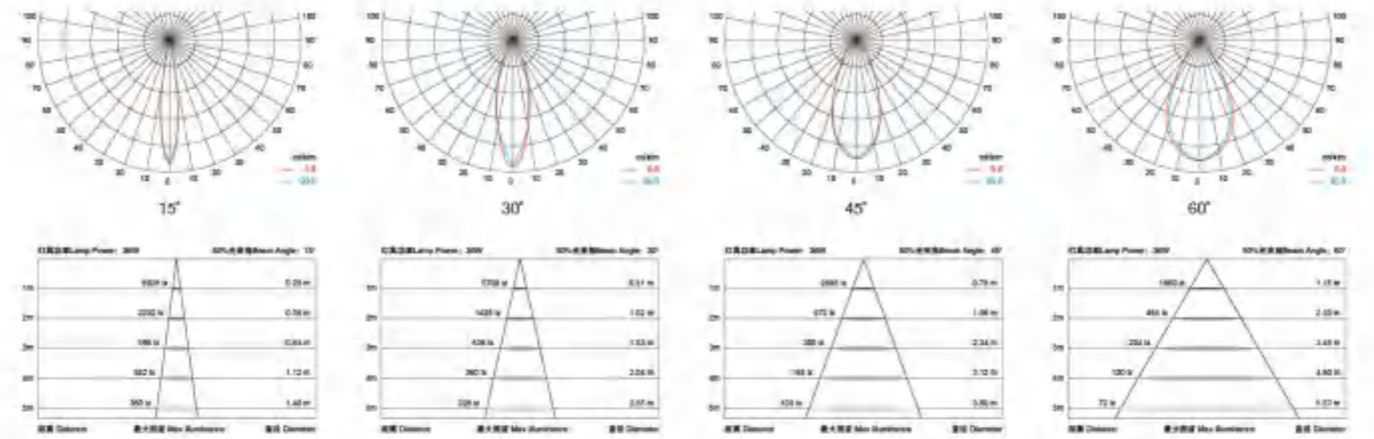

技术参数 Specification

类别	参数	类别	参数	类别	参数
额定功率 Rated Power	36W	光源 / 数量 LED Quantity	LED / 36pcs	输入电压 Input Voltage	DC 24V / AC 220V
色温 Color Temperature	3000K / 4000K / 5700K / RGB	50%光束角 50% Beam Angle	15° 30° 45° 60°	控制方式 Control Mode	ON-OFF / DMX512
使用寿命 Life	>30000H	防护等级 Protection Grade	IP 67	工作环境温度 Temperature of Working Condition	-25°C~50°C
灯具净重 Net Weight	5.5kg	中包规格 Package Specification	325x325x115mm	外箱规格 / 数量 Outside Box Specification / Quantity	330x330x250mm / 2pcs



材质 Material



产品尺寸 Product Size

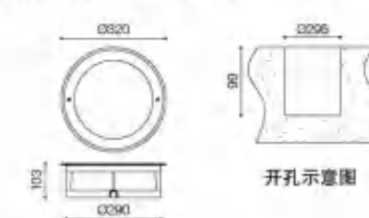

BT7035S

专利设计 DESIGN PATENT



二次光学透镜配光, 多种角度选择。
Scientific optical lens with different beam angle choice.



可选配蜂窝格栅防眩光罩。
Optional cellular anti glare grille mask.



旋转结构设计, 可旋转15度。
Rotating structure design, can rotate 15 degrees.



整体注塑预埋桶, 便于安装维护。
Plastic recessed housing, convenient for installation and maintenance.

适用场合

主要应用于草坪、花园、公园、小区道路, 步行街等。

The Application of Occasions

Suitable places: Lawn, Garden, Park, Path, Pedestrian, Precinct etc.

产品特点说明

- 灯体主体部分采用高压压铸铝和不锈钢, 表面采用静电喷塑和电泳处理, 防腐蚀、抗老化, 延长使用寿命。
- 透光罩采用钢化超白玻璃, 更有效的提高了光的透射率。
- 采用光学透镜二次配光, 根据实际应用可选择透镜角度。
- 采用高效率、高稳定性恒流驱动电源, 保证了光源的稳定工作, 降低光衰, 延长使用寿命。
- 灯体表面设计了横纵向散热片更有利于通风, 增加散热面积, 迅速散热, 升华了灯具的整体美观程度。
- 独立的电源腔体设计, 有效的保证了电源的散热, 延长电源使用寿命。
- 安装采用塑料预埋件, 安装简洁方便。
- 采用硅橡胶密封结构设计, 有效保证了防护等级IP67。

Product Description

- Aluminium die-cast housing, stainless steel cover, double anti-corrosion to extend service life.
- Ultrawhite tempered glass diffuser, effectively improve the transmission rate of light.
- Scientific optical lens design, with different lens angle choice.
- High efficiency constant current driver, ensure the light source is maximum used.
- Lateral and axial heat sink design on light body surface, increase the efficiency of heat-dissipation.
- Independent power supply recessed design, extend the power supply working life.
- Plastic recessed housing included.
- Using silicone rubber leakproof structure design to ensure the high level of IP rating (IP:67).



配光曲线 Light Distribution Curve

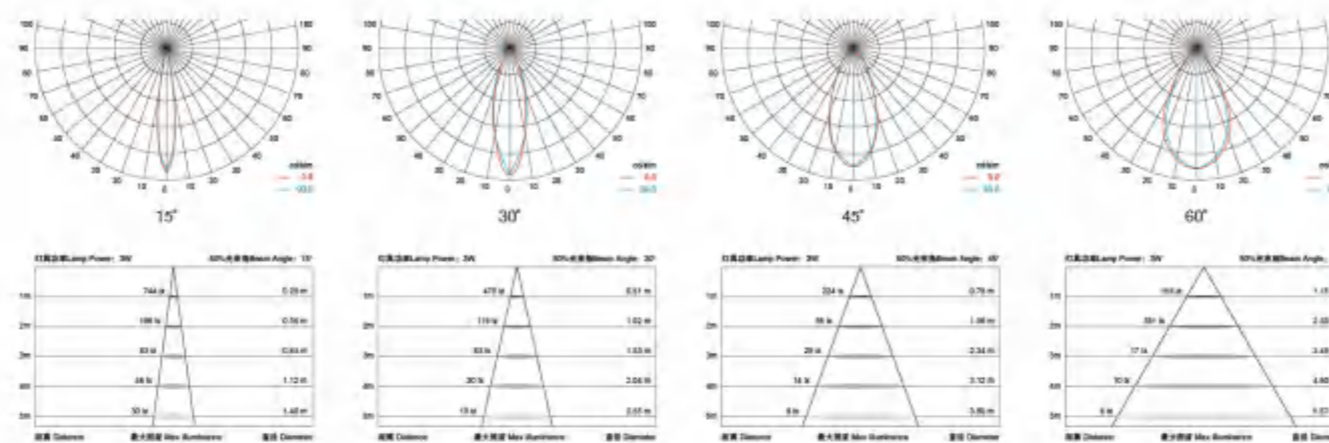

技术参数 Specification

类别	参数	类别	参数	类别	参数
额定功率 Rated Power	3W	光源 / 数量 LED Quantity	LED / 3pcs	输入电压 Input Voltage	DC 24V / AC 220V
色温 Color Temperature	3000K / 4000K / 5700K / RGB	50%光束角 50% Beam Angle	15° 30° 45° 60°	控制方式 Control Mode	ON-OFF / DMX512
使用寿命 Life	>30000H	防护等级 Protection Grade	IP 67	工作环境温度 Temperature of Working Condition	-25°C~50°C
灯具净重 Net Weight	1kg	中包规格 Package Specification	135x135x150mm	外箱规格 / 数量 Outside Box Specification / Quantity	560x430x330mm / 24pcs

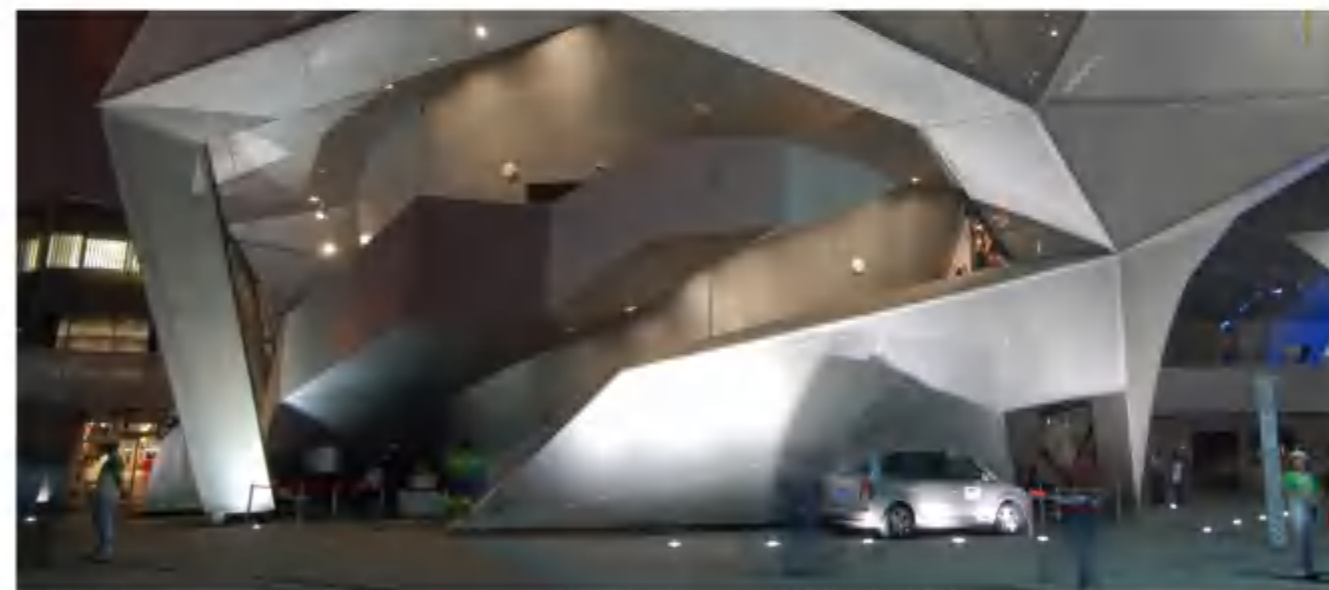

材质 Material



产品尺寸 Product Size

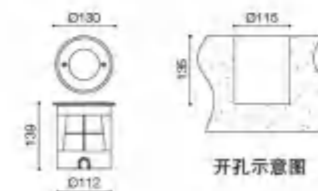

BT7035B

专利设计 DESIGN PATENT



二次光学透镜配光，多种角度选择。
Scientific optical lens with different beam angle choice.



可选配蜂窝格栅防眩光罩。
Optional cellular anti glare grille mask.



旋转结构设计，可旋转15度。
Rotating structure design, can rotate 15 degrees.



整体注塑预埋桶，便于安装维护。
Plastic recessed housing, convenient for installation and maintenance.

适用场合

主要应用于草坪、花园、公园、小区道路，步行街等。

The Application of Occasions

Suitable places: Lawn, Garden, Park, Path, Pedestrian, Precinct etc.

产品特点说明

- 灯体主体部分采用高压压铸铝和不锈钢，表面采用静电喷塑和电泳处理，防腐蚀、抗老化，延长使用寿命。
- 透光罩采用钢化超白玻璃，更有效的提高了光的透射率。
- 采用光学透镜二次配光，根据实际应用可选择透镜角度。
- 采用高效率、高稳定性恒流驱动电源，保证了光源的稳定工作，降低光衰，延长使用寿命。
- 灯体表面设计了横纵向散热片更有利于通风，增加散热面积，迅速散热，升华了灯具的整体美观程度。
- 独立的电源腔体设计，有效的保证了电源的散热，延长电源使用寿命。
- 安装采用塑料预埋件，安装简洁方便。
- 采用硅橡胶密封结构设计，有效保证了防护等级IP67。

Product Description

- Aluminium die-cast housing, stainless steel cover, double anti-corrosion to extend service life.
- Ultrawhite tempered glass diffuser, effectively improve the transmission rate of light.
- Scientific optical lens design, with different lens angle choice.
- High efficiency constant current driver, ensure the light source is maximum used.
- Lateral and axial heat sink design on light body surface, increase the efficiency of heat-dissipation.
- Independent power supply recessed design, extend the power supply working life.
- Plastic recessed housing included.
- Using silicone rubber leakproof structure design to ensure the high level of IP rating (IP-67).



配光曲线 Light Distribution Curve

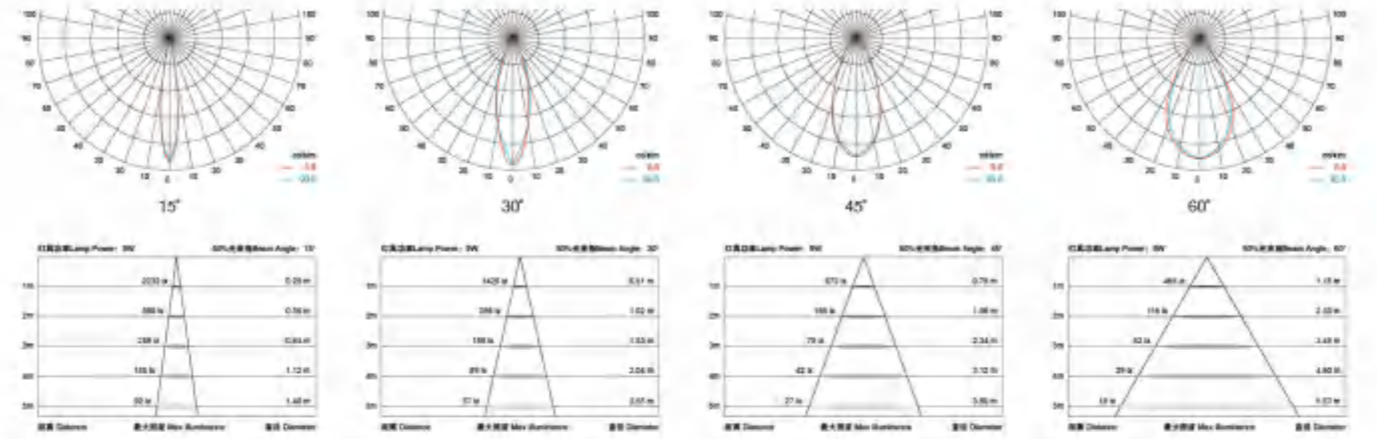

技术参数 Specification

类别	参数	类别	参数	类别	参数
额定功率 Rated Power	9W	光源 / 数量 LED Quantity	LED / 9pcs	输入电压 Input Voltage	DC 24V / AC 220V
色温 Color Temperature	3000K / 4000K / 5700K / RGB	50%光束角 50% Beam Angle	15° 30° 45° 60°	控制方式 Control Mode	ON-OFF / DMX512
使用寿命 Life	>30000H	防护等级 Protection Grade	IP 67	工作环境温度 Temperature of Working Condition	-25°C~50°C
灯具净重 Net Weight	1.7kg	中包规格 Package Specification	165x165x165mm	外箱规格 / 数量 Outside Box Specification / Quantity	520x350x360mm / 12pcs



材质 Material



产品尺寸 Product Size

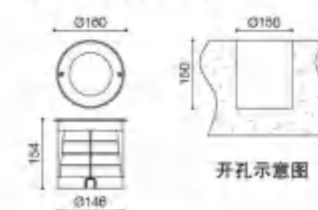

BT7035C

专利设计 DESIGN PATENT



二次光学透镜配光, 多种角度选择。
Scientific optical lens with different beam angle choice.

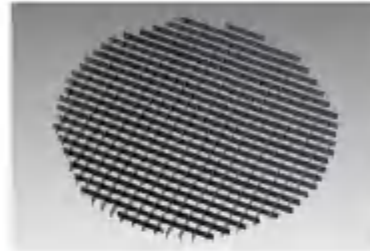

可选配蜂窝格栅防眩光罩。
Optional cellular anti glare grille mask.



旋转结构设计, 可旋转15度。
Rotating structure design, can rotate 15 degrees.



整体注塑预埋桶, 便于安装维护。
Plastic recessed housing, convenient for installation and maintenance.

适用场合

主要应用于草坪、花园、公园、小区道路, 步行街等。

The Application of Occasions

Suitable places: Lawn, Garden, Park, Path, Pedestrian, Precinct etc.

产品特点说明

- 灯体主体部分采用高压压铸铝和不锈钢, 表面采用静电喷塑和电泳处理, 防腐蚀、抗老化, 延长使用寿命。
- 透光罩采用钢化超白玻璃, 更有效的提高了光的透射率。
- 采用光学透镜二次配光, 根据实际应用可选择透镜角度。
- 采用高效率、高稳定性恒流驱动电源, 保证了光源的稳定工作, 降低光衰, 延长使用寿命。
- 灯体表面设计了纵向散热片更有利于通风, 增加散热面积, 迅速散热, 升华了灯具的整体美观程度。
- 独立的电源腔体设计, 有效的保证了电源的散热, 延长电源使用寿命。
- 安装采用塑料预埋件, 安装简洁方便。
- 采用硅橡胶密封结构设计, 有效保证了防护等级IP67。

Product Description

- Aluminium die-cast housing, stainless steel cover, double anti-corrosion to extend service life.
- Ultrawhite tempered glass diffuser, effectively improve the transmission rate of light.
- Scientific optical lens design, with different lens angle choice.
- High efficiency constant current driver, ensure the light source is maximum used.
- Lateral and axial heat sink design on light body surface, increase the efficiency of heat-dissipation.
- Independent power supply recessed design, extend the power supply working life.
- Plastic recessed housing included.
- Using silicone rubber leakproof structure design to ensure the high level of IP rating (IP:67).



配光曲线 Light Distribution Curve

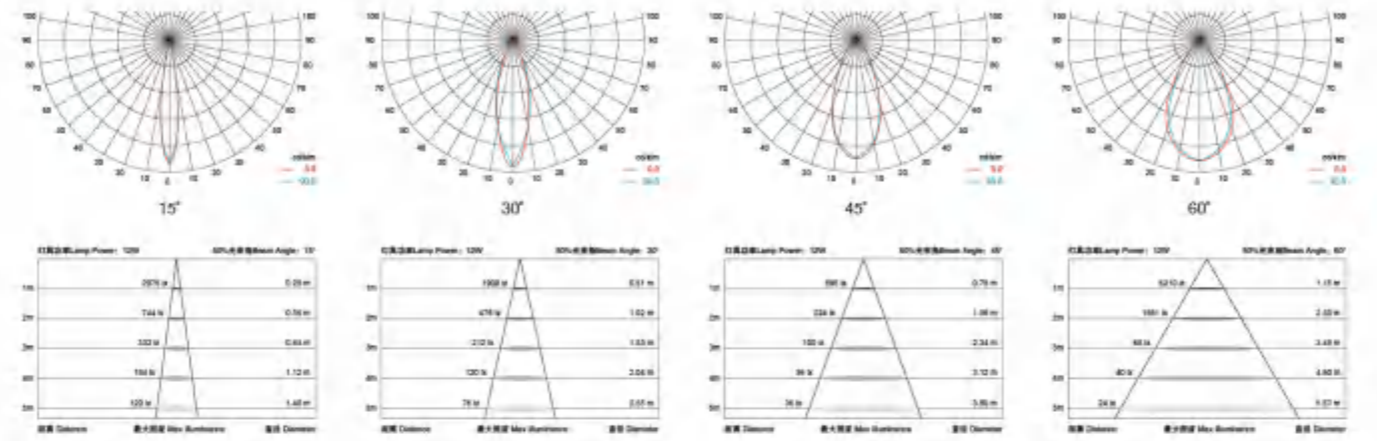

技术参数 Specification

类别	参数	类别	参数	类别	参数
额定功率 Rated Power	12W	光源 / 数量 LED Quantity	LED / 12pcs	输入电压 Input Voltage	DC 24V / AC 220V
色温 Color Temperature	3000K / 4000K / 5700K / RGB	50°光束角 50° Beam Angle	15° 30° 45° 60°	控制方式 Control Mode	ON-OFF / DMX512
使用寿命 Life	>30000H	防护等级 Protection Grade	IP 67	工作环境温度 Temperature of Working Condition	-25°C~50°C
灯具净重 Net Weight	3.1kg	中包规格 Package Specification	215x215x255mm	外箱规格 / 数量 Outside Box Specification / Quantity	450x450x540mm / 8pcs



材质 Material



产品尺寸 Product Size

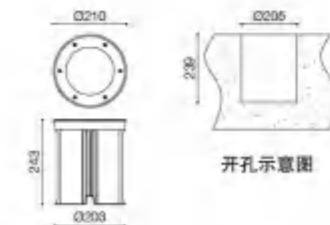

BT7035E

专利设计 DESIGN PATENT



二次光学透镜配光，多种角度选择。
Scientific optical lens with different beam angle choice.



可选配蜂窝格栅防眩光罩。
Optional cellular anti glare grille mask.



旋转结构设计，可旋转15度。
Rotating structure design, can rotate 15 degrees.



整体注塑预埋桶，便于安装维护。
Plastic recessed housing, convenient for installation and maintenance.

适用场合

主要应用于草坪、花园、公园、小区道路、步行街等。

The Application of Occasions

Suitable places: Lawn, Garden, Park, Path, Pedestrian, Precinct etc.

产品特点说明

1. 灯体主体部分采用高压压铸铝和不锈钢，表面采用静电喷塑和电泳处理，防腐蚀、抗老化，延长使用寿命。
2. 透光罩采用钢化超白玻璃，更有效的提高了光的透射率。
3. 采用光学透镜二次配光，根据实际应用可选择透镜角度。
4. 采用高效率、高稳定性恒流驱动电源，保证了光源的稳定工作，降低光衰，延长使用寿命。
5. 灯体表面设计了横纵向散热片更有利于通风，增加散热面积，迅速散热，升华了灯具的整体美观程度。
6. 独立的电源腔体设计，有效的保证了电源的散热，延长电源使用寿命。
7. 安装采用塑料预埋件，安装简洁方便。
8. 采用硅橡胶密封结构设计，有效保证了防护等级IP67。

Product Description

1. Aluminium die-cast housing, stainless steel cover, double anti-corrosion to extend service life.
2. Ultrawhite tempered glass diffuser, effectively improve the transmission rate of light.
3. Scientific optical lens design, with different lens angle choice.
4. High efficiency constant current driver, ensure the light source is maximum used.
5. Lateral and axial heat sink design on light body surface, increase the efficiency of heat-dissipation.
6. Independent power supply recessed design, extend the power supply working life.
7. Plastic recessed housing included.
8. Using silicone rubber leakproof structure design to ensure the high level of IP rating (IP:67).



配光曲线 Light Distribution Curve

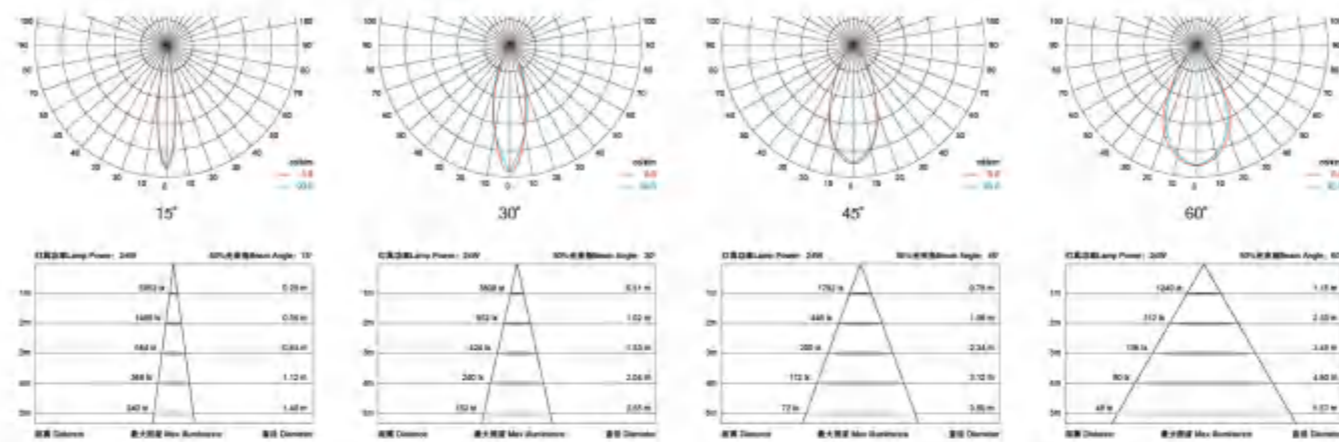

技术参数 Specification

类别	参数	类别	参数	类别	参数
额定功率 Rated Power	24W	光源 / 数量 LED Quantity	LED / 24pcs	输入电压 Input Voltage	DC 24V / AC 220V
色温 Color Temperature	3000K / 4000K / 5700K / RGB	50%光束角 50% Beam Angle	15° 30° 45° 60°	控制方式 Control Mode	ON-OFF / DMX512
使用寿命 Life	>30000H	防护等级 Protection Grade	IP 67	工作环境温度 Temperature of Working Condition	-25°C~50°C
灯具净重 Net Weight	4.7kg	中包规格 Package Specification	265x265x205mm	外箱规格 / 数量 Outer Box Specification / Quantity	550x280x440mm / 4pcs



材质 Material



产品尺寸 Product Size

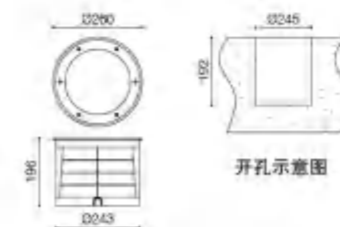

开孔示意图

BT7006P-LED9

专利设计 DESIGN PATENT



光源偏光设计。
Polarized light source design.

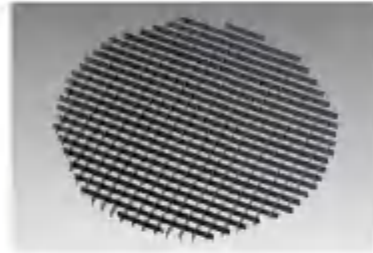

可选配蜂窝格栅防眩光罩。
Optional cellular anti glare grille mask.



配置可调节照射角度装置。
With adjustable beam angle device.



整体注塑预埋桶，便于安装维护。
Plastic recessed housing, convenient for installation and maintainance.

适用场合

主要应用于草坪、花园、公园、小区道路、步行街等。

The Application of Occasions

Suitable places: Lawn, Garden, Park, Path, Pedestrian, Precinct etc.

产品特点说明

1. 灯体采用高强度压铸铝一次成型，表面静电喷塑处理，防腐蚀、抗老化，延长使用寿命。
2. 不锈钢面盖，表面精工抛光电泳处理。
3. 透光罩采用透明加厚钢化玻璃，增强耐压程度和透光效率。
4. 反光罩采用进口铝板成型表面氧化处理，提高反射效率。
5. 防眩光装置和可调节角度装置，更为人性化处理和推广应用。
6. 采用硅橡胶密封结构设计，有效保证了防护等级IP67。
7. 安装采用塑料预埋件，使得安装方便。

Product Description

1. Aluminium die-cast body, coated with outdoor used powder, double anti-corrosion to ensure long life-span.
2. Stainless steel cover, polish and electrophoresised with clear lacquer.
3. Using thick transparent tempered glass diffuser, strengthen pressure-resistant and luminous efficacy.
4. Scientific aluminium reflector, anodised surface, deeply improve the reflect efficiency.
5. Humanized anti-dizzy device and angle adjusting device, deeply improve the product quality level.
6. Using silicone rubber leakproof structure design to ensure the high level of IP rating(IP:67).
7. Plastic recessed housing included.

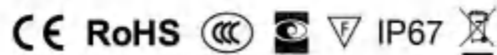

配光曲线 Light Distribution Curve

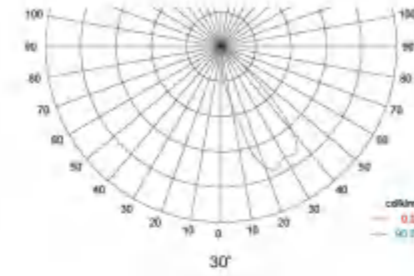

等照度图 Illumination Map

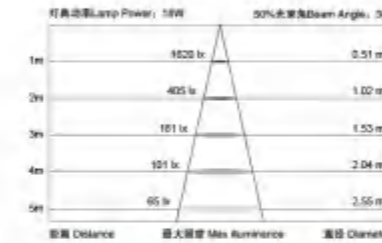

技术参数 Specification

类别	Product Code	参 数 Parameter
额定功率	Rated Power	18W
光源 / 数量	LED Quantity	LED / 9pcs
输入电压	Input Voltage	DC 24V / AC 220V
色温	Color Temperature	3000K / 4000K / 5700K / RGB
50%光束角	50% Beam Angle	30°
控制方式	Control Mode	ON-OFF / DMX512
使用寿命	Life	>30000H
防护等级	Protection Grade	IP 67
工作环境温度	Temperature of Working Condition	-25°C-50°C
灯具净重	Net Weight	3kg
中包规格	Package Specification	215x215x280mm
外箱规格 / 数量	Outside Box Specifications / Quantity	650x450x260mm / 6pcs.



材质 Material



产品尺寸 Product Size

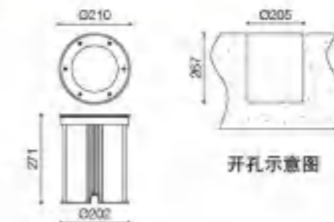

BT7007P-LED15

专利设计 DESIGN PATENT



一次成型聚光罩设计。
The design of primary forming condenser.

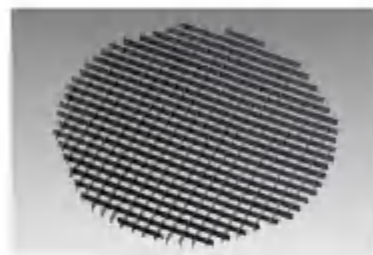

可选配蜂窝格栅防眩光罩。
Optional cellular anti glare grille mask.



配置可调节照射角度装置。
With adjustable beam angle device.



整体注塑预埋桶，便于安装维护。
Plastic recessed housing, convenient for installation and maintainance.

适用场合

主要应用于草坪、花园、公园、小区道路，步行街等。

The Application of Occasions

Suitable places: Lawn, Garden, Park, Path, Pedestrian, Precinct etc.

产品特点说明

1. 灯体采用高强度压铸铝一次成型，表面静电喷塑处理，防腐蚀、抗老化，延长使用寿命。
2. 不锈钢面盖，表面精工抛光电泳处理。
3. 透光罩采用透明加厚钢化玻璃，增强耐压程度和透光效率。
4. 反光罩采用进口铝板成型表面氧化处理，提高反射效率。
5. 防眩光装置和可调节角度装置，更为人性化处理和推广应用。
6. 采用硅橡胶密封结构设计，有效保证了防护等级IP67。
7. 安装采用塑料预埋件，使得安装方便。

Product Description

1. Aluminium die-cast body, coated with outdoor used powder, double anti-corrosion to ensure long life-span.
2. Stainless steel cover, polish and electrophoresised with clear lacquer.
3. Using thick transparent tempered glass diffuser, strengthen pressure-resistant and luminous efficacy.
4. Scientific aluminium reflector, anodised surface, deeply improve the reflect efficiency.
5. Humanized anti-dizzy device and angle adjusting device, deeply improve the product quality level.
6. Using silicone rubber leakproof structure design to ensure the high level of IP rating(IP:67).
7. Plastic recessed housing included.

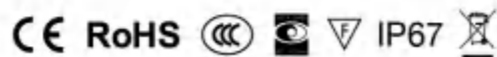

配光曲线 Light Distribution Curve

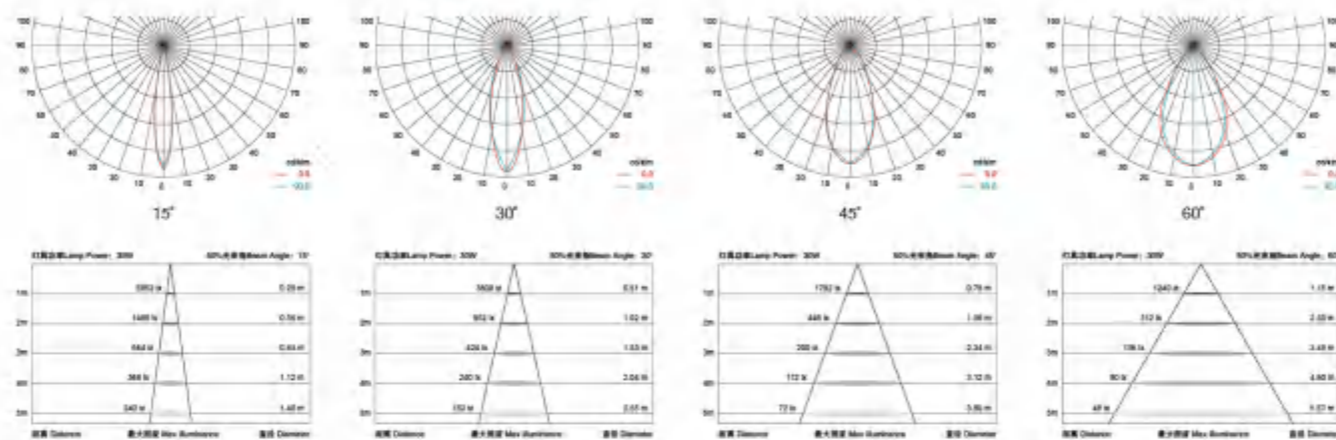

技术参数 Specification

类别	参数	类别	参数	类别	参数
额定功率 Rated Power	30W	光源 / 数量 LED Quantity	LED / 15pcs	输入电压 Input Voltage	DC 24V / AC 220V
色温 Color Temperature	3000K / 4000K / 5700K / RGB	50%光束角 50% Beam Angle	15° 30° 45° 60°	控制方式 Control Mode	ON-OFF / DMX512
使用寿命 Life	>30000H	防护等级 Protection Grade	IP 67	工作环境温度 Temperature of Working Condition	-25°C~50°C
灯具净重 Net Weight	3.4kg	中包规格 Package Specification	235x235x300mm	外箱规格 / 数量 Outside Box Specification / Quantity	480x480x320mm / 4pcs



材质 Material



产品尺寸 Product Size

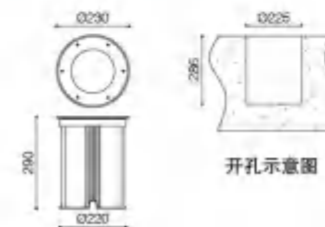

BT7007P230

专利设计 DESIGN PATENT



螺钉机械固定有效保证防水性能。
Screw fixed with machinery design, to ensure the waterproofness.



配置可调节照射角度及防眩光装置。
With adjustable beam angle device and anti-glare device.



进口铝旋压反光罩，表面特种工艺处理。
Imported aluminium reflector.



整体注塑预埋桶，便于安装维护。
Plastic recessed housing, convenient for installation and maintenance.

适用场合

主要应用于草坪、花园、公园、小区道路，步行街等。

The Application of Occasions

Suitable places: Lawn, Garden, Park, Path, Pedestrian, Precinct etc.

产品特点说明

1. 灯体采用高强度压铸铝一次成型，表面静电喷塑处理，防腐蚀、抗老化，延长使用寿命。
2. 不锈钢面盖，表面精加工抛光电泳处理。
3. 透光罩采用透明加厚钢化玻璃，增强耐压程度和透光效率。
4. 反光罩采用进口铝板成型表面氧化处理，提高反射效率。
5. 防眩光装置和可调节角度装置，更为人性化处理和推广应用。
6. 采用硅橡胶密封结构设计，有效保证了防护等级IP67。
7. 安装采用塑料预埋件，使得安装方便。

Product Description

1. Aluminium die-cast body, coated with outdoor used powder, double anti-corrosion to ensure long life-span.
2. Stainless steel cover, polish and electrophoresised with clear lacquer.
3. Using thick transparent tempered glass diffuser, strengthen pressure-resistant and luminous efficacy.
4. Scientific aluminium reflector, anodised surface, deeply improve the reflect efficiency.
5. Humanized anti-dizzy device and angle adjusting device, deeply improve the product quality level.
6. Using silicone rubber leakproof structure design to ensure the high level of IP rating(IP:67).
7. Plastic recessed housing included.

CE RoHS CCC IP67

配光曲线 Light Distribution Curve

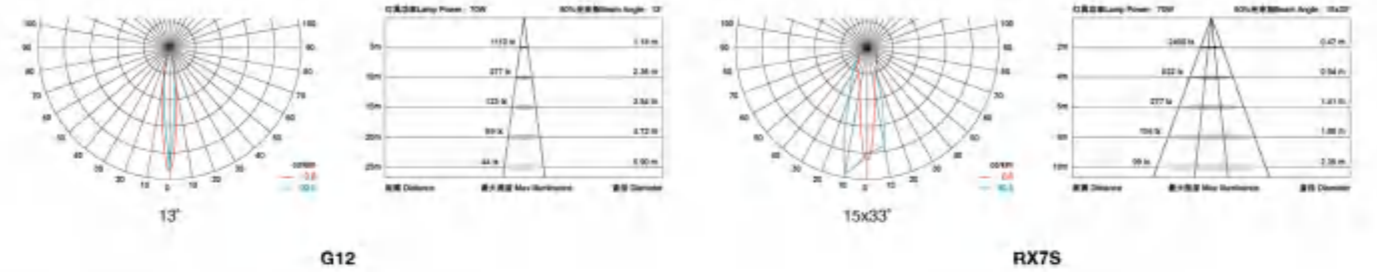

技术参数 Specification

类别 Category	参数 Parameter	类别 Category	参数 Parameter	类别 Category	参数 Parameter
额定功率 Rated Power	70W	光源 / 数量 LED Quantity	G12 / RX7S / 1pcs	输入电压 Input Voltage	AC 220V
色温 Color Temperature	3000K / 4200K	50%光束角 50% Beam Angle	13° / 15x33°	控制方式 Control Mode	ON-OFF
使用寿命 Life	>30000H	防护等级 Protection Grade	IP 67	工作环境温度 Temperature of Working Condition	-25°C~50°C
灯具净重 Net Weight	4.1kg	中包规格 Package Specification	235x235x300mm	外箱规格 / 数量 Outside Box Specifications / Quantity	480x480x320mm / 4pcs



材质 Material



产品尺寸 Product Size

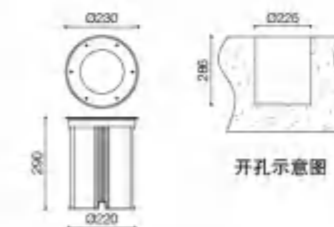

BT7008P260

专利设计 DESIGN PATENT



螺钉机械固定有效保证防水性能。
Screw fixed with machinery design, to ensure the waterproofness.



配置可调节照射角度及防眩光装置。
With adjustable beam angle device and anti-glare device.



进口铝旋压反光罩，表面特种工艺处理。
Imported aluminium reflector.



整体注塑预埋桶，便于安装维护。
Plastic recessed housing, convenient for installation and maintenance.

适用场合

主要应用于草坪、花园、公园、小区道路，步行街等。

The Application of Occasions

Suitable places: Lawn, Garden, Park, Path, Pedestrian, Precinct etc.

产品特点说明

1. 灯体采用高强度压铸铝一次成型，表面静电喷塑处理，防腐蚀、抗老化，延长使用寿命。
2. 不锈钢面盖，表面精加工抛光电泳处理。
3. 透光罩采用透明加厚钢化玻璃，增强耐压程度和透光效率。
4. 反光罩采用进口铝板成型表面氧化处理，提高反射效率。
5. 防眩光装置和可调节角度装置，更为人性化处理和推广应用。
6. 采用硅橡胶密封结构设计，有效保证了防护等级IP67。
7. 安装采用塑料预埋件，使得安装方便。

Product Description

1. Aluminium die-cast body, coated with outdoor used powder, double anti-corrosion to ensure long life-span.
2. Stainless steel cover, polish and electrophoresised with clear lacquer.
3. Using thick transparent tempered glass diffuser, strengthen pressure-resistant and luminous efficacy.
4. Scientific aluminium reflector, anodised surface, deeply improve the reflect efficiency.
5. Humanized anti-dizzy device and angle adjusting device, deeply improve the product quality level.
6. Using silicone rubber leakproof structure design to ensure the high level of IP rating(IP:67).
7. Plastic recessed housing included.



配光曲线 Light Distribution Curve

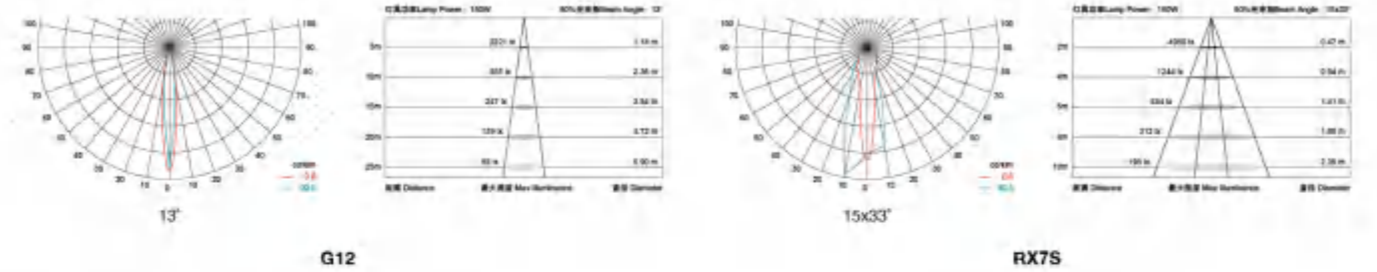

技术参数 Specification

参数 Parameter	单位 Unit	类别 Category	数量 Quantity	类别 Category	参数 Parameter
额定功率 Rated Power	150W	光源 / 数量 LED Quantity	G12 / RX7S / 1pcs	输入电压 Input Voltage	AC 220V
色温 Color Temperature	3000K / 4200K	50%光束角 50% Beam Angle	13° / 15x33°	控制方式 Control Mode	ON-OFF
使用寿命 Life	>30000H	防护等级 Protection Grade	IP 67	工作环境温度 Temperature of Working Condition	-25°C~50°C
灯具净重 Net Weight	5.5kg	中包规格 Package Specification	265x265x325mm	外箱规格 / 数量 Outside Box Specifications / Quantity	550x550x330mm / 4pcs



材质 Material



产品尺寸 Product Size

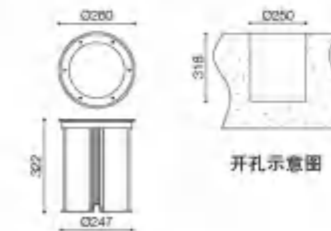

BT7025BM

专利设计 DESIGN PATENT



二次光学透镜配光，多种角度选择。
Scientific optical lens with different beam angle choice.



可选配蜂窝格栅防眩光罩。
Optional cellular anti glare grille mask.



敞开式散热片，提高散热效果。
Open-type heat sink, improve heat-dissipation efficiency.



整体金属预埋桶，便于安装维护。
Metal recessed housing, convenient for installation and maintainance.

适用场合

主要应用于草坪、花园、公园、小区道路，步行街等。

The Application of Occasions

Suitable places: Lawn, Garden, Park, Path, Pedestrian, Precinct etc.

产品特点说明

- 灯体主体部分采用高压压铸铝和不锈钢，表面采用静电喷塑和电泳处理，防腐蚀、抗老化，延长使用寿命。
- 透光罩采用钢化超白玻璃，更有效的提高了光的透射率。
- 采用光学透镜二次配光，根据实际应用可选择透镜角度。
- 采用高效率、高稳定性恒流驱动电源，保证了光源的稳定工作，降低光衰，延长使用寿命。
- 灯体表面设计了横纵向散热片更有利于通风，增加散热面积，迅速散热，升华了灯具的整体美观程度。
- 独立的电源腔体设计，有效的保证了电源的散热，延长电源使用寿命。
- 安装采用金属预埋件，安装简洁方便。
- 采用硅橡胶密封结构设计，有效保证了防护等级IP67。

Product Description

- Aluminium die-cast housing, stainless steel cover, double anti-corrosion to extend service life.
- Ultrawhite tempered glass diffuser, effectively improve the transmission rate of light.
- Scientific optical lens design, with different lens angle choice.
- High efficiency constant current driver, ensure the light source is maximum used.
- Lateral and axial heat sink design on light body surface, increase the efficiency of heat-dissipation.
- Independent power supply recessed design, extend the power supply working life.
- Metal recessed housing included.
- Using silicone rubber leakproof structure design to ensure the high level of IP rating (IP:67).



配光曲线 Light Distribution Curve

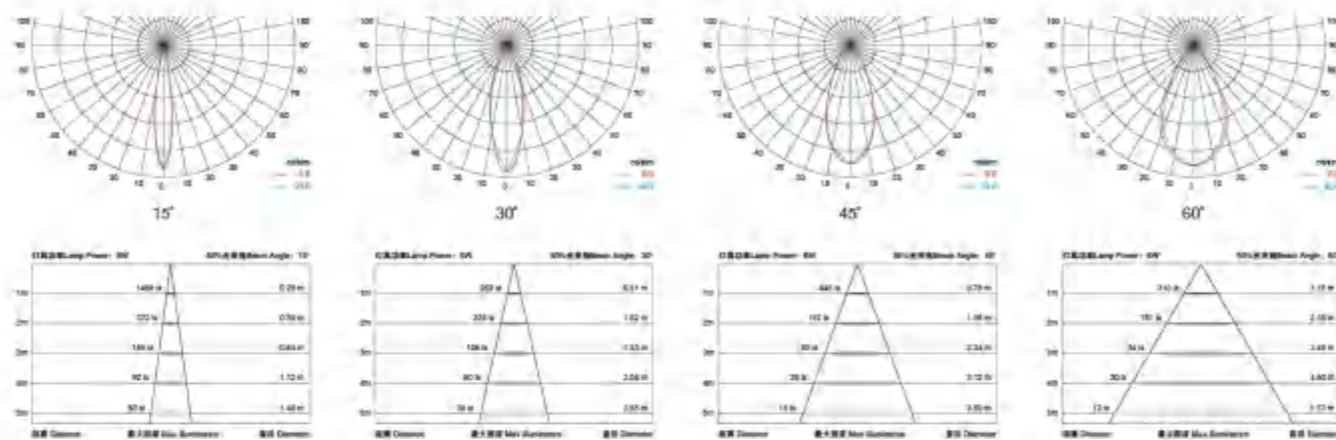

技术参数 Specification

参数	指标	单位	备注	参数	指标
额定功率 Rated Power	6W			光源 / 数量 LED Quantity	LED / 6pcs
色温 Color Temperature	3000K / 4000K / 5700K / RGB			50%光束角 50% Beam Angle	15° 30° 45° 60°
使用寿命 Life	>30000H			防护等级 Protection Grade	IP 67
灯具净重 Net Weight	2.3kg			外包装规格 / 数量 Package Specification / Quantity	230x230x230mm 480x480x250mm / 4pcs
				输入电压 Input Voltage	DC 24V / AC 220V
				控制方式 Control Mode	ON-OFF / DMX512
				工作环境温度 Temperature of Working Condition	-25°C~50°C



颜色选择 Color Selection

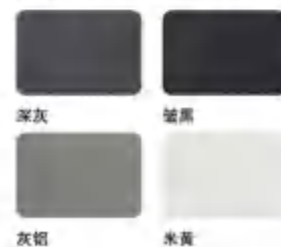

材质 Material



产品尺寸 Product Size

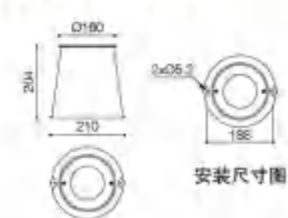

BT7007PM-LED15

专利设计 DESIGN PATENT



二次光学透镜配光, 多种角度选择。
Scientific optical lens with different beam angle choice.



可选配蜂窝格栅防眩光罩。
Optional cellular anti glare grille mask.



配置可调节照射角度装置。
With adjustable beam angle device.

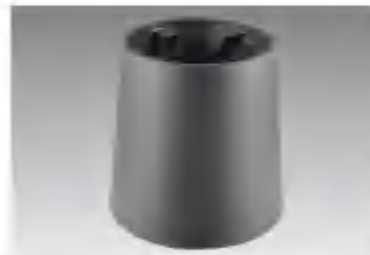

整体金属预埋桶, 便于安装维护。
Metal recessed housing, convenient for installation and maintenance.

适用场合

主要应用于草坪、花园、公园、小区道路, 步行街等。

The Application of Occasions

Suitable places: Lawn, Garden, Park, Path, Pedestrian, Precinct etc.

产品特点说明

- 灯体主体部分采用高压压铸铝和不锈钢, 表面采用静电喷塑和电泳处理, 防腐蚀、抗老化, 延长使用寿命。
- 透光罩采用钢化超白玻璃, 更有效的提高了光的透射率。
- 采用光学透镜二次配光, 根据实际应用可选择透镜角度。
- 采用高效率、高稳定性恒流驱动电源, 保证了光源的稳定工作, 降低光衰, 延长使用寿命。
- 灯体表面设计了纵向散热片更有利于通风, 增加散热面积, 迅速散热, 升华了灯具的整体美观程度。
- 独立的电源腔体设计, 有效的保证了电源的散热, 延长电源使用寿命。
- 安装采用金属预埋件, 安装简洁方便。
- 采用硅橡胶密封结构设计, 有效保证了防护等级IP67。

Product Description

- Aluminium die-cast housing, stainless steel cover, double anti-corrosion to extend service life.
- Ultrawhite tempered glass diffuser, effectively improve the transmission rate of light.
- Scientific optical lens design, with different lens angle choice.
- High efficiency constant current driver, ensure the light source is maximum used.
- Lateral and axial heat sink design on light body surface, increase the efficiency of heat-dissipation.
- Independent power supply recessed design, extend the power supply working life.
- Metal recessed housing included.
- Using silicone rubber leakproof structure design to ensure the high level of IP rating (IP-67).



配光曲线 Light Distribution Curve

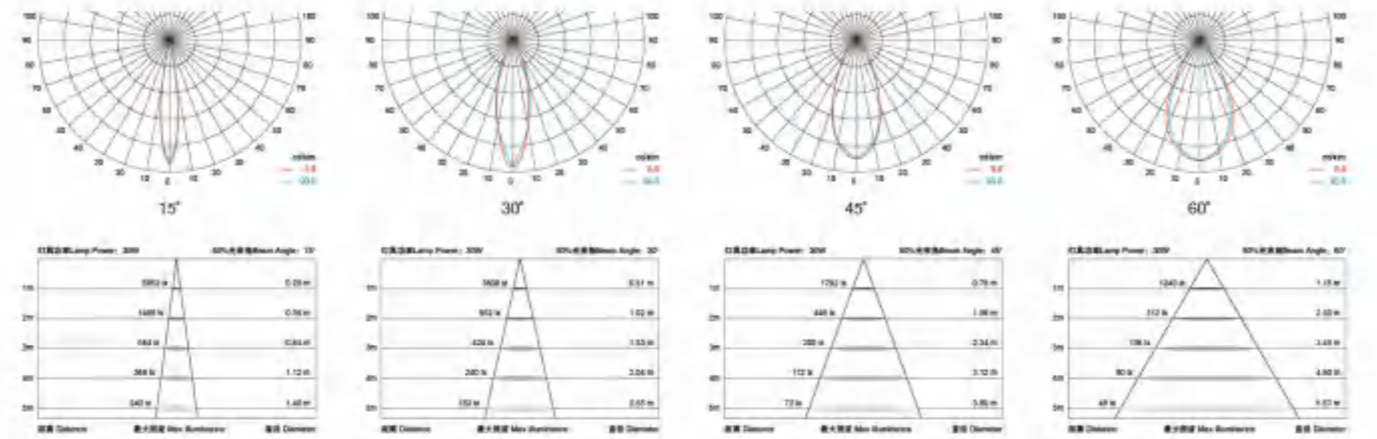

技术参数 Specification

参数 Parameter	指标 Indicator	参数 Parameter	指标 Indicator
额定功率 Rated Power	30W	光源 / 数量 LED Quantity	LED / 15pcs
色温 Color Temperature	3000K / 4000K / 5700K / RGB	50%光束角 50% Beam Angle	15° 30° 45° 60°
使用寿命 Life	>30000H	防护等级 Protection Grade	IP 67
灯具净重 Net Weight	5.2kg	中包规格 Package Specification	305x305x305mm
		输入电压 Input Voltage	DC 24V / AC 220V
		控制方式 Control Mode	ON-OFF / DMX512
		工作环境温度 Temperature of Working Condition	-25°C~50°C
		外箱规格 / 数量 Outside Box Specification / Quantity	620x320x320mm / 2pcs



颜色选择 Color Selection

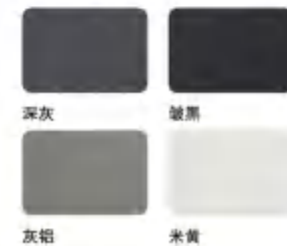

产品尺寸 Product Size

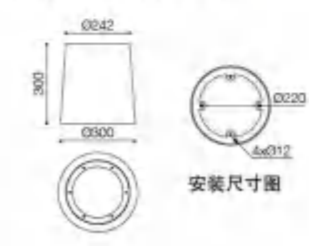

BT7007PM242

专利设计 DESIGN PATENT

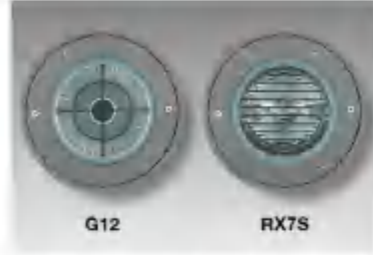

螺钉机械固定有效保证防水性能。
Screw fixed with machinery design, to ensure the waterproofness.



配置可调节照射角度及防眩光装置。
With adjustable beam angle device and anti-glare device.



进口铝旋压反光罩，表面特种工艺处理。
Imported aluminium reflector.



整体金属预埋桶，便于安装维护。
Metal recessed housing, convenient for installation and maintainance.

适用场合

主要应用于草坪、花园、公园、小区道路、步行街等。

The Application of Occasions

Suitable places: Lawn, Garden, Park, Path, Pedestrian, Precinct etc.

产品特点说明

1. 灯体主体部分采用高压压铸铝和不锈钢，表面采用静电喷塑和电泳处理，防腐蚀、抗老化，延长使用寿命。
2. 透光罩采用钢化超白玻璃，更有效的提高了光的透射率。
3. 采用光学透镜二次配光，根据实际应用可选择透镜角度。
4. 采用高效率、高稳定性恒流驱动电源，保证了光源的稳定工作，降低光衰，延长使用寿命。
5. 灯体表面设计了横向散热片更有利于通风，增加散热面积，迅速散热，升华了灯具的整体美观程度。
6. 独立的电源腔体设计，有效的保证了电源的散热，延长电源使用寿命。
7. 安装采用金属预埋件，安装简洁方便。
8. 采用硅胶橡胶密封结构设计，有效保证了防护等级IP67。

Product Description

1. Aluminium die-cast housing, stainless steel cover, double anti-corrosion to extend service life.
2. Ultrawhite tempered glass diffuser, effectively improve the transmission rate of light.
3. Scientific optical lens design, with different lens angle choice.
4. High efficiency constant current driver, ensure the light source is maximum used.
5. Lateral and axial heat sink design on light body surface, increase the efficiency of heat-dissipation.
6. Independent power supply recessed design, extend the power supply working life.
7. Metal recessed housing included.
8. Using silicone rubber leakproof structure design to ensure the high level of IP rating (IP:67).



配光曲线 Light Distribution Curve

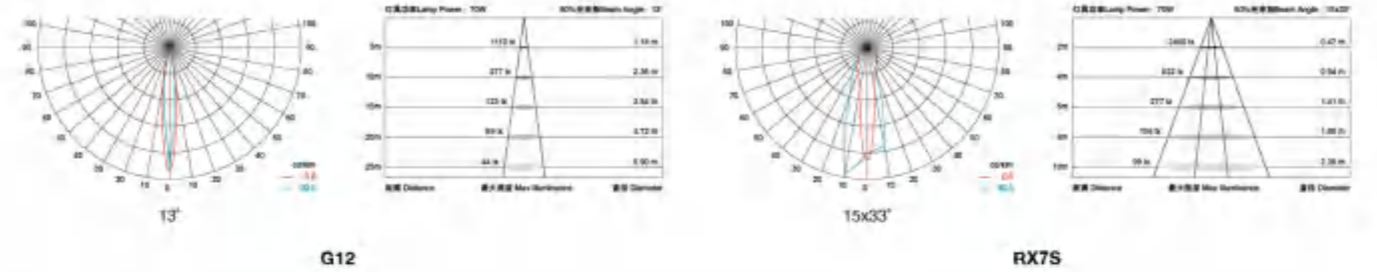

技术参数 Specification

名称 Name	参数 Parameter	名称 Name	参数 Parameter	名称 Name	参数 Parameter
额定功率 Rated Power	70W	光源 / 数量 LED Quantity	G12 / RX7S / 1pcs	输入电压 Input Voltage	AC 220V
色温 Color Temperature	3000K / 4200K	50%光束角 50% Beam Angle	13° / 15x33°	控制方式 Control Mode	ON-OFF
使用寿命 Life	>30000H	防护等级 Protection Grade	IP 67	工作环境温度 Temperature of Working Condition	-25°C~50°C
灯具净重 Net Weight	8kg	中包规格 Package Specification	305x305x306mm	外箱规格 / 数量 Outside Box Specifications / Quantity	620x320x320mm / 2pcs



颜色选择 Color Selection

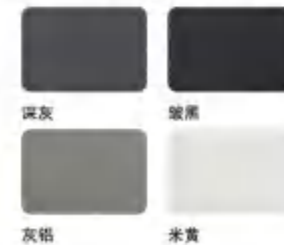

产品尺寸 Product Size

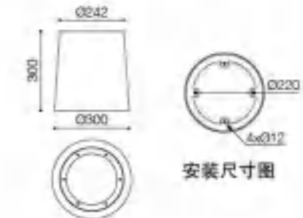

BT9218M

专利设计 DESIGN PATENT



二次光学透镜配光，多种角度选择。
Scientific optical lens with different beam angle choice.



便携式机械固定安装。
Portable mechanical mounting.



压铸端盖，优质硅胶密封。
Aluminium die-cast end cap with quality silicone rubber.

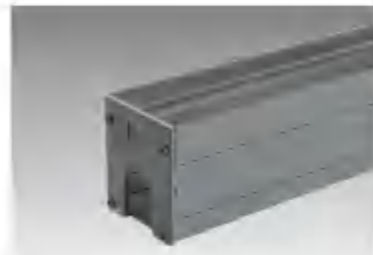

整体金属预埋槽，便于安装维护。
Metal recessed housing, convenient for installation and maintenance.

适用场合

主要应用于草坪、花园、公园、小区道路、步行街等。

The Application of Occasions

Suitable places: Lawn, Garden, Park, Path, Pedestrian, Precinct etc.

产品特点说明

1. 灯体主体部分采用高压压铸铝和不锈钢，表面采用静电喷塑和电泳处理，防腐蚀、抗老化，延长使用寿命。
2. 透光罩采用钢化超白玻璃，更有效的提高了光的透射率。
3. 采用光学透镜二次配光，根据实际应用可选择透镜角度。
4. 采用高效率、高稳定性恒流驱动电源，保证了光源的稳定工作，降低光衰，延长使用寿命。
5. 灯体表面设计了纵向散热片更有利于通风，增加散热面积，迅速散热，升华了灯具的整体美观程度。
6. 独立的电源腔体设计，有效的保证了电源的散热，延长电源使用寿命。
7. 安装采用金属预埋件，安装简洁方便。
8. 采用硅胶橡胶密封结构设计，有效保证了防护等级IP67。

Product Description

1. Aluminium die-cast housing, stainless steel cover, double anti-corrosion to extend service life.
2. Ultrawhite tempered glass diffuser, effectively improve the transmission rate of light.
3. Scientific optical lens design, with different lens angle choice.
4. High efficiency constant current driver, ensure the light source is maximum used.
5. Lateral and axial heat sink design on light body surface, increase the efficiency of heat-dissipation.
6. Independent power supply recessed design, extend the power supply working life.
7. Metal recessed housing included.
8. Using silicone rubber leakproof structure design to ensure the high level of IP rating (IP:67).

CE RoHS CCC IP67

配光曲线 Light Distribution Curve

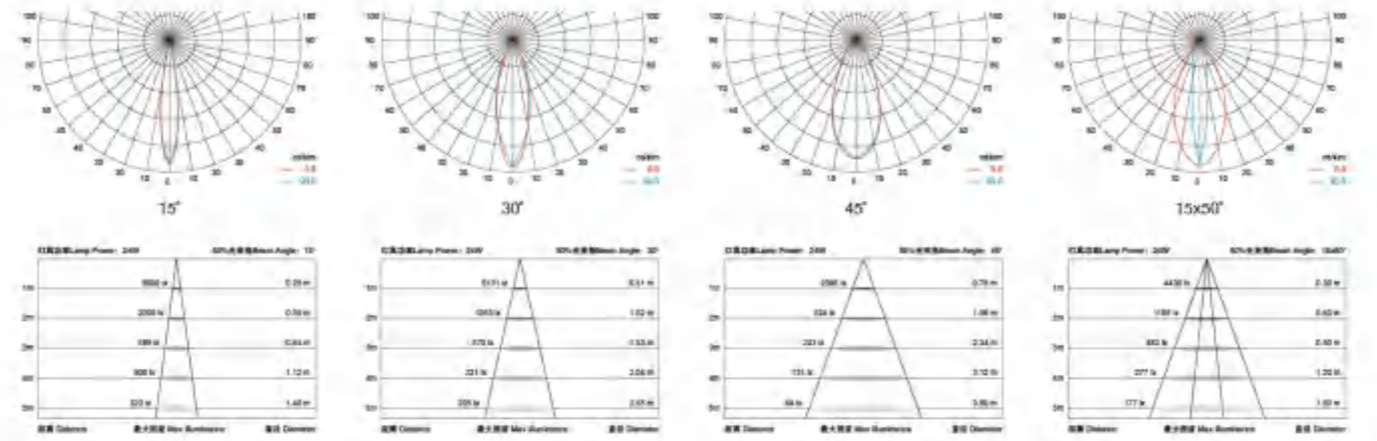

技术参数 Specification

类别	参数	类别	参数	类别	参数
额定功率 Rated Power	24W	光源 / 数量 LED Quantity	LED / 24pcs	输入电压 Input Voltage	DC 24V / AC 220V
色温 Color Temperature	3000K / 4000K / 5700K / RGB	50%光束角 50% Beam Angle	15° 30° 45° 15x50°	控制方式 Control Mode	ON-OFF / DMX512
使用寿命 Life	>30000H	防护等级 Protection Grade	IP 67	工作环境温度 Temperature of Working Condition	-25°C~50°C
灯具净重 Net Weight	6.2kg	中包规格 Package Specification	115x105x1010mm	外箱规格 / 数量 Display Box Specification / Quantity	1030x250x130mm / 2pcs



材质 Material



产品尺寸 Product Size

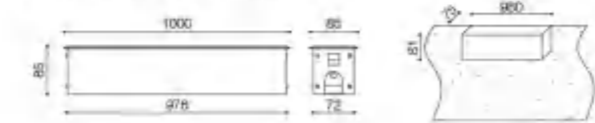

开孔示意图

BT7115E

专利设计 DESIGN PATENT



整体压铸，外观表面特种工艺处理。
Integral casting, special processing on surface.



RGB DMX512控制，实现多种变化模式。
RGB DMX512 control, Various control mode combination.



敞开式散热片，提高散热效果。
Open-type heat sink, improve heat-dissipation efficiency.



可旋转安装支架，配套加强安装底板。
Rotatable mounting bracket with strong mounting plate.

适用场合

主要应用于水族馆、水池雕塑、广场喷泉、游泳池等。

The Application of Occasions

Suitable places: Aquatic animals exhibition halls, Water pool sculptures, Fountains, Swimming pools etc.

产品特点说明

1. 极简的工业设计造型，美学与实用的完美结合，外观和结构专利。
2. 灯体主体部分采用不锈钢整体浇注而成，表面精工处理后再全灯电泳处理，防腐性、抗老化，延长使用寿命。
3. 透光罩采用钢化玻璃，提高了灯具整体的美观程度，灵活的二次光学透镜配光，根据实际需要多种光束角选择。
4. 采用高效率、高稳定性恒流驱动电源，保证了光源的稳定工作，降低光衰，延长使用寿命。
5. 散热主体表面设计了横纵向散热片更有利于通风，增加散热面积，迅速散热，升华了灯具的整体美观程度。
6. 采用硅橡胶密封结构设计，有效保证了防护等级IP68。
7. 可旋转安装支架设计，根据实际应用调节角度，使得应用发挥到最佳状态，并且整灯安装简便。

Product Description

1. Simple and practical design, Perfect aesthetic and practical union, patented appearance and structure technology.
2. Stainless steel casting body, surface finishing and electrophoresis coated to expand the working life.
3. Tempered glass diffuser, effectively improve the transmission rate of light. Multiple Beam-angle choice.
4. High efficiency constant current driver, ensure the light source is maximum used.
5. Lateral and Axial Heat sink design on the light body surface, increase the efficiency of heat-dissipation.
6. Using silicone rubber leakproof structure design to ensure the high level of IP rating (IP:68).
7. Rotatable mounting bracket design to achieve the best light efficiency.

CE RoHS CCC IP68

配光曲线 Light Distribution Curve

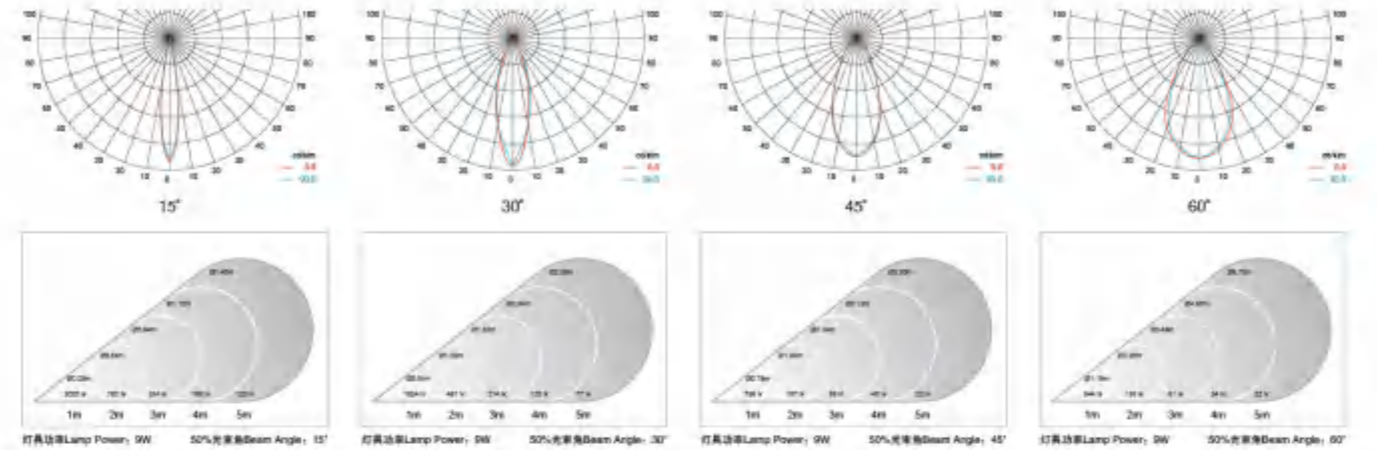

技术参数 Specification

类别	参数	类别	参数	类别	参数
额定功率 Rated Power	9W	光源 / 数量 LED Quantity	LED / 6pcs	输入电压 Input Voltage	DC 24V / DC 12V
色温 Color Temperature	3000K / 4000K / 5700K / RGB	50%光束角 50% Beam Angle	15° 30° 45° 60°	控制方式 Control Mode	ON-OFF / DMX512
使用寿命 Life	>30000H	防护等级 Protection Grade	IP 68	工作环境温度 Temperature of Working Condition	-25°C-50°C
灯具净重 Net Weight	1.8kg	中包规格 Package Specification	175x135x110mm	外箱规格 / 数量 Outside Box Specifications / Quantity	370x290x250mm / 8pcs



材质 Material



产品尺寸 Product Size

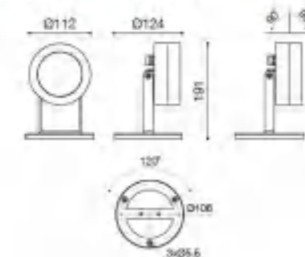

BT7115B

专利号 Num: 201230154198.0



整体压铸，外观表面特种工艺处理。
Integral casting, special processing on surface.



RGB DMX512控制，实现多种变化模式。
RGB DMX512 control, Various control mode combination.

适用场合

主要应用于水族馆、水池雕塑、广场喷泉、游泳池等。

The Application of Occasions

Suitable places: Aquatic animals exhibition halls, Water pool sculptures, Fountains, Swimming pools etc.

产品特点说明

1. 极简的工业设计造型，美学与实用的完美结合，外观和结构专利。
2. 灯体主体部分采用不锈钢整体浇注而成，表面精加工处理后再全灯电泳处理，防腐性、抗老化，延长使用寿命。
3. 透光罩采用钢化玻璃，提高了灯具整体的美观程度，灵活的二次光学透镜配光，根据实际需要多种光束角选择。
4. 采用高效率、高稳定性恒流驱动电源，保证了光源的稳定工作，降低光衰，延长使用寿命。
5. 散热主体表面设计了横纵向散热片更有利于通风，增加散热面积，迅速散热，升华了灯具的整体美观程度。
6. 采用硅橡胶密封结构设计，有效保证了防护等级IP68。
7. 可旋转安装支架设计，根据实际应用调节角度，使得应用发挥到最佳状态，并且整灯安装简便。

Product Description

1. Simple and practical design, Perfect aesthetic and practical union, patented appearance and structure technology.
2. Stainless steel casting body, surface finishing and electrophoresis coated to expand the working life.
3. Tempered glass diffuser, effectively improve the transmission rate of light. Multiple Beam-angle choice.
4. High efficiency constant current driver, ensure the light source is maximum used.
5. Lateral and Axial Heat sink design on the light body surface, increase the efficiency of heat-dissipation.
6. Using silicone rubber leakproof structure design to ensure the high level of IP rating (IP:68).
7. Rotatable mounting bracket design to achieve the best light efficiency.



敞开式散热片，提高散热效果。
Open-type heat sink, improve heat-dissipation efficiency.



可旋转安装支架，配套加强安装底板。
Rotatable mounting bracket with strong mounting plate.



配光曲线 Light Distribution Curve

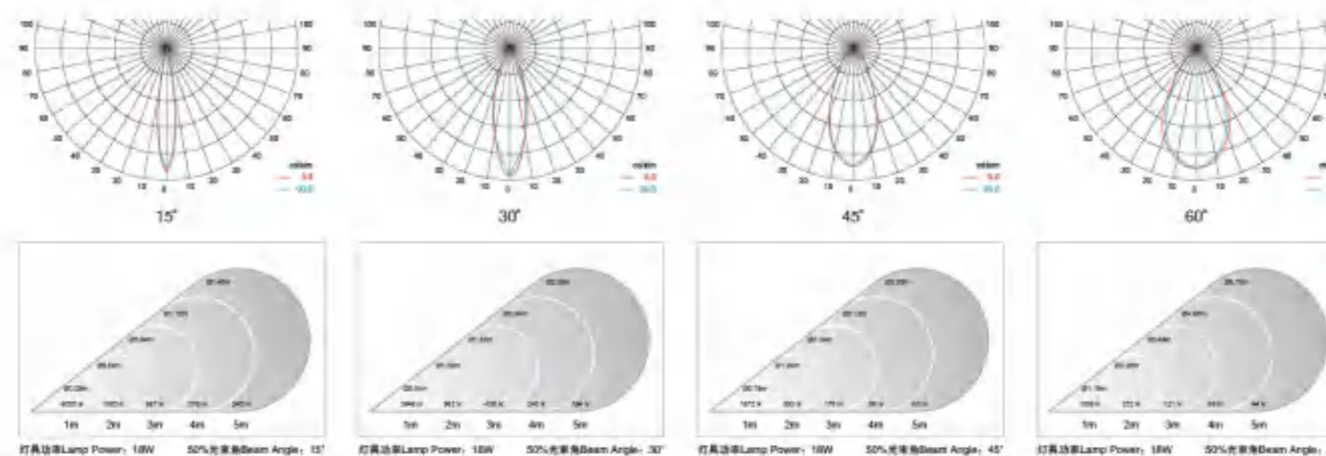

技术参数 Specification

类别	参数	类别	参数	类别	参数
额定功率 Rated Power	18W	光源 / 数量 LED Quantity	LED / 12pcs	输入电压 Input Voltage	DC 24V / DC 12V
色温 Color Temperature	3000K / 4000K / 5700K / RGB	50%光束角 50% Beam Angle	15° 30° 45° 60°	控制方式 Control Mode	ON-OFF / DMX512
使用寿命 Life	>30000H	防护等级 Protection Grade	IP 68	工作环境温度 Temperature of Working Condition	-25°C-50°C
灯具净重 Net Weight	2.7kg	中包规格 Package Specification	220x150x110mm	外箱规格 / 数量 Outside Box Specifications / Quantity	320x240x250mm / 6pcs

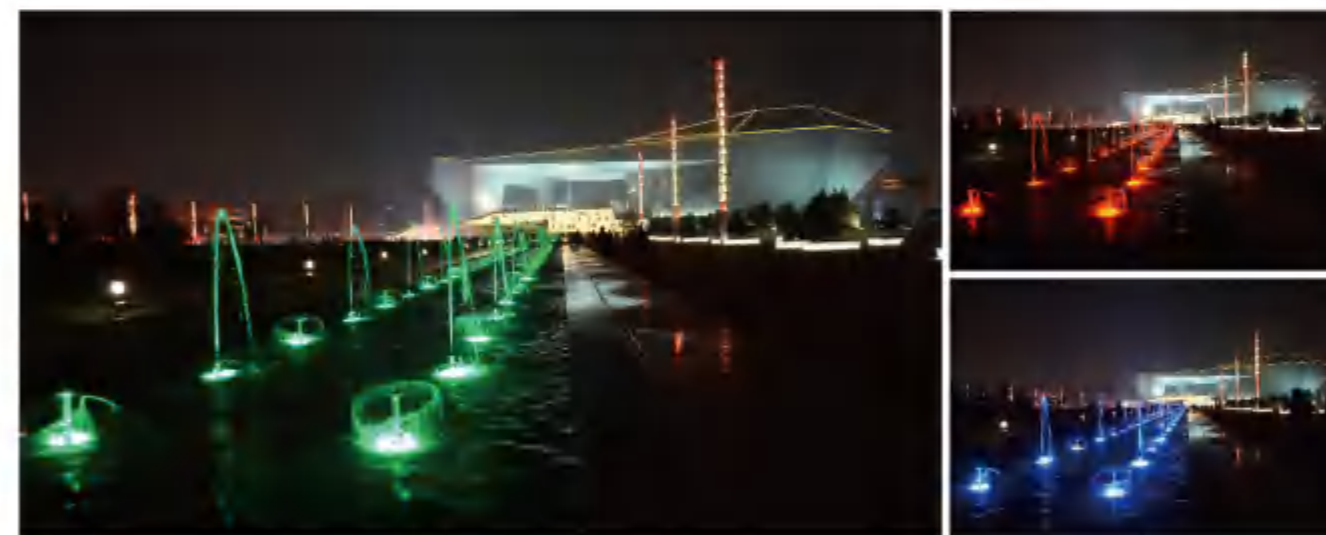

材质 Material



产品尺寸 Product Size

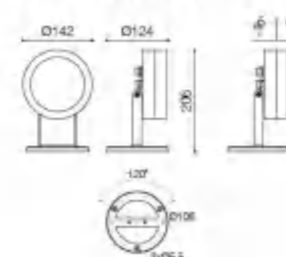

BT7115C

专利号 Num: 201230154193.8



整体压铸，外观表面特种工艺处理。
Integral casting, special processing on surface.



RGB DMX512控制，实现多种变化模式。
RGB DMX512 control, Various control mode combination.



敞开式散热片，提高散热效果。
Open-type heat sink, improve heat-dissipation efficiency.



可旋转安装支架，配套加强安装底板。
Rotatable mounting bracket with strong mounting plate.

适用场合

主要应用于水族馆、水池雕塑、广场喷泉、游泳池等。

The Application of Occasions

Suitable places: Aquatic animals exhibition halls, Water pool sculptures, Fountains, Swimming pools etc.

产品特点说明

1. 极简的工业设计造型，美学与实用的完美结合，外观和结构专利。
2. 灯体主体部分采用不锈钢整体浇注而成，表面精加工处理后再全灯电泳处理，防腐性、抗老化，延长使用寿命。
3. 透光罩采用钢化玻璃，提高了灯具整体的美观程度，灵活的二次光学透镜配光，根据实际需要多种光束角选择。
4. 采用高效率、高稳定性恒流驱动电源，保证了光源的稳定工作，降低光衰，延长使用寿命。
5. 散热主体表面设计了横纵向散热片更有利于通风，增加散热面积，迅速散热，升华了灯具的整体美观程度。
6. 采用硅橡胶密封结构设计，有效保证了防护等级IP68。
7. 可旋转安装支架设计，根据实际应用调节角度，使得应用发挥到最佳状态，并且整灯安装简便。

Product Description

1. Simple and practical design, Perfect aesthetic and practical union, patented appearance and structure technology.
2. Stainless steel casting body, surface finishing and electrophoresis coated to expand the working life.
3. Tempered glass diffuser, effectively improve the transmission rate of light. Multiple Beam-angle choice.
4. High efficiency constant current driver, ensure the light source is maximum used.
5. Lateral and Axial Heat sink design on the light body surface, increase the efficiency of heat-dissipation.
6. Using silicone rubber leakproof structure design to ensure the high level of IP rating (IP:68).
7. Rotatable mounting bracket design to achieve the best light efficiency.



配光曲线 Light Distribution Curve

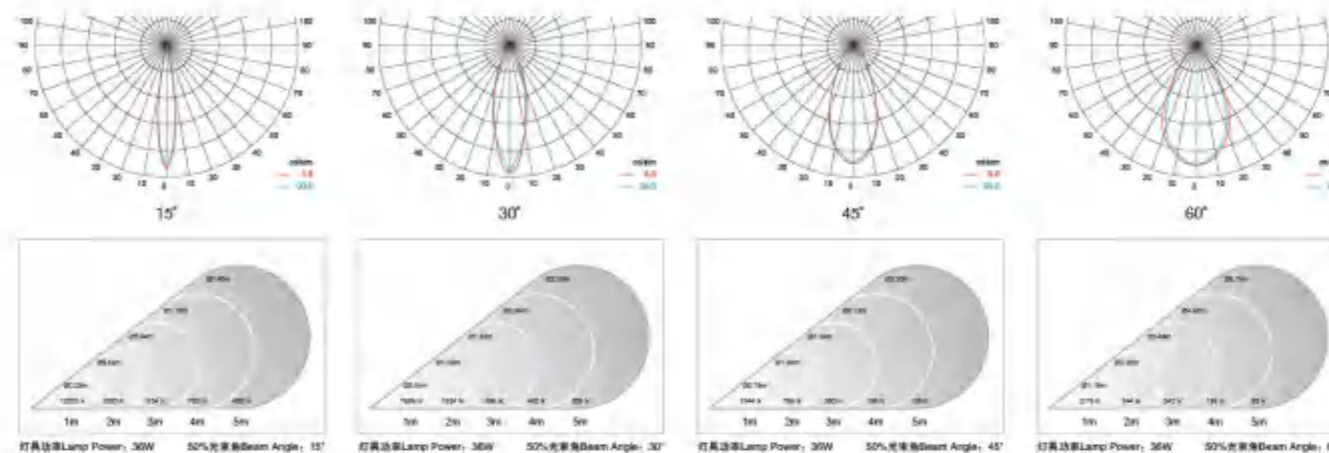

技术参数 Specification

类别	参数	类别	参数	类别	参数
额定功率 Rated Power	36W	光源 / 数量 LED Quantity	LED / 24pcs	输入电压 Input Voltage	DC 24V / DC 12V
色温 Color Temperature	3000K / 4000K / 5700K / RGB	50%光束角 50% Beam Angle	15° 30° 45° 60°	控制方式 Control Mode	ON-OFF / DMX512
使用寿命 Life	>30000H	防护等级 Protection Grade	IP 68	工作环境温度 Temperature of Working Condition	-25°C~50°C
灯具净重 Net Weight	4.5kg	中包规格 Package Specification	240x200x110mm	外箱规格 / 数量 Outside Box Specifications / Quantity	420x260x250mm / 4pcs



材质 Material



产品尺寸 Product Size

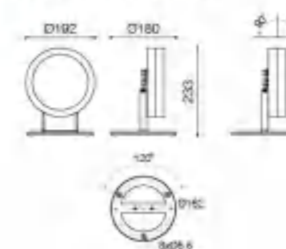

BT7115D

专利号 Num: 201230154194.2



整体压铸，外观表面特种工艺处理。
Integral casting, special processing on surface.



RGB DMX512控制，实现多种变化模式。
RGB DMX512 control, Various control mode combination.



敞开式散热片，提高散热效果。
Open-type heat sink, improve heat-dissipation efficiency.



可旋转安装支架，配套加强安装底板。
Rotatable mounting bracket with strong mounting plate.

适用场合

主要应用于水族馆、水池雕塑、广场喷泉、游泳池等。

The Application of Occasions

Suitable places: Aquatic animals exhibition halls, Water pool sculptures, Fountains, Swimming pools etc.

产品特点说明

1. 极简的工业设计造型，美学与实用的完美结合，外观和结构专利。
2. 灯体主体部分采用不锈钢整体浇注而成，表面精加工处理后再全灯电泳处理，防腐性、抗老化，延长使用寿命。
3. 透光罩采用钢化玻璃，提高了灯具整体的美观程度，灵活的二次光学透镜配光，根据实际需要多种光束角选择。
4. 采用高效率、高稳定性恒流驱动电源，保证了光源的稳定工作，降低光衰，延长使用寿命。
5. 散热主体表面设计了横纵向散热片更有利于通风，增加散热面积，迅速散热，升华了灯具的整体美观程度。
6. 采用硅橡胶密封结构设计，有效保证了防护等级IP68。
7. 可旋转安装支架设计，根据实际应用调节角度，使得应用发挥到最佳状态，并且整灯安装简便。

Product Description

1. Simple and practical design, Perfect aesthetic and practical union, patented appearance and structure technology.
2. Stainless steel casting body, surface finishing and electrophoresis coated to expand the working life.
3. Tempered glass diffuser, effectively improve the transmission rate of light. Multiple Beam-angle choice.
4. High efficiency constant current driver, ensure the light source is maximum used.
5. Lateral and Axial Heat sink design on the light body surface, increase the efficiency of heat-dissipation.
6. Using silicone rubber leakproof structure design to ensure the high level of IP rating (IP-68).
7. Rotatable mounting bracket design to achieve the best light efficiency.



配光曲线 Light Distribution Curve

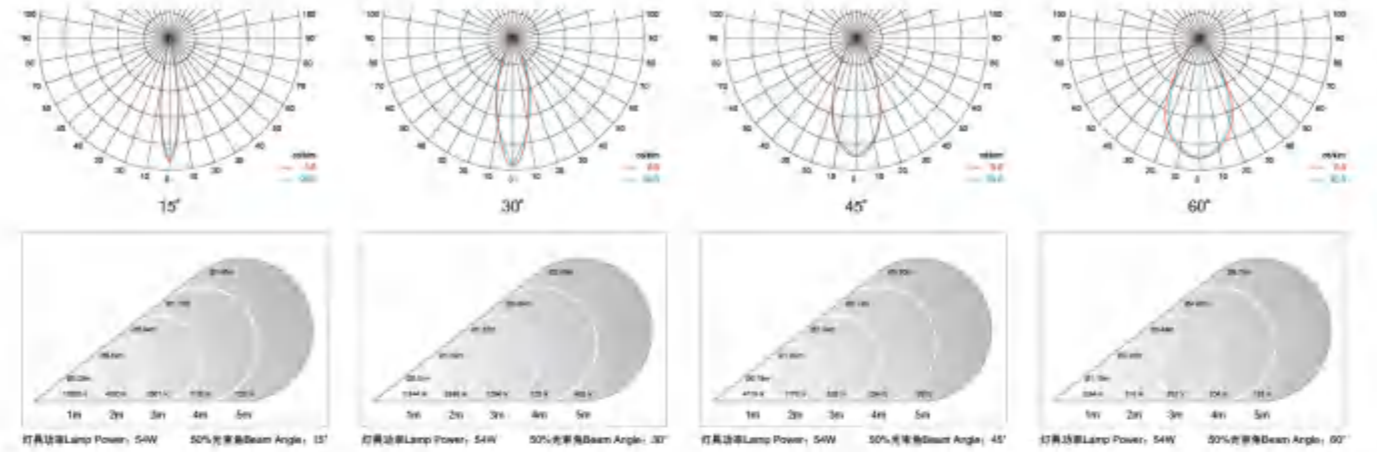

技术参数 Specification

参数 (Parameter)	数值 (Value)	参数 (Parameter)	数值 (Value)
额定功率 (Rated Power)	54W	光源 / 数量 (LED Quantity)	LED / 36pcs
色温 (Color Temperature)	3000K / 4000K / 5700K / RGB	50%光束角 (50% Beam Angle)	15° 30° 45° 60°
使用寿命 (Life)	>30000H	防护等级 (Protection Grade)	IP 68
灯具净重 (Net Weight)	5.3kg	中包规格 (Package Specification)	290x240x110mm
		输入电压 (Input Voltage)	DC 24V / DC 12V
		控制方式 (Control Mode)	ON-OFF / DMX512
		工作环境温度 (Temperature of Working Condition)	-25°C~50°C
		外箱规格 / 数量 (Outside Box Specifications / Quantity)	500x290x240mm / 4pcs



材质 Material



产品尺寸 Product Size

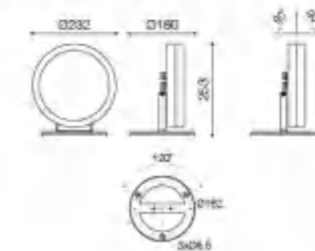

BT2801A

专利设计 DESIGN PATENT



BT2801B

专利设计 DESIGN PATENT



BT2801C

专利设计 DESIGN PATENT



适用场合

主要应用于室内装饰、户外走廊、庭院等。

产品特点说明

1. 经典的工业设计造型，美学与实用的完美结合，外观和结构专利。
2. 灯体主体部分采用高压压铸铝，表面静电喷塑处理，防腐性、抗老化，延长使用寿命。
3. 透光罩采用钢化磨砂玻璃，使得光线更加均匀柔和。
4. 电器板采用钣金冲压成型，表面喷白处理，电气安装方便同时有效提高了光的利用率。
5. 灯体面罩根据实际安装场景和所需效果可多种选择。
6. 采用硅橡胶密封结构设计，有效保证了防护等级IP65。
7. 安装采用金属预埋盒，使得安装方便牢固。

The Application of Occasions

Suitable places: Interior decoration, Outdoor corridor, Garden etc.

Product Description

1. Classical industrial design, Perfect aesthetic and practical union.
2. High pressure Aluminium die-cast body, coated with outdoor used powder, double anti-corrosion to extend service life.
3. Frosted tempered glass diffuser, make the light downy and evenness.
4. Stamping wire plate, coated in pure white, effectively improve the utilization of light.
5. Multiple lamp cover choice.
6. Using silicone rubber leakproof structure design to ensure the high level of IP rating (IP:65).
7. Using metal recessed housing, simple installation.

CE RoHS CCC IP65

配光曲线 Light Distribution Curve

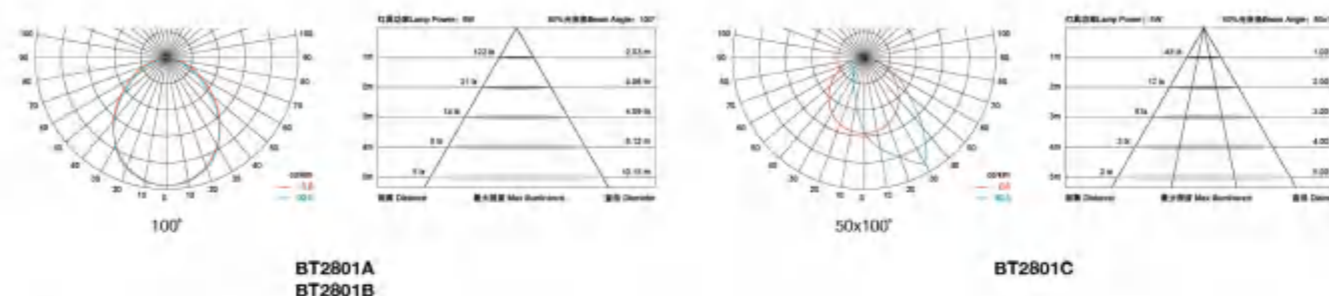

技术参数 Specification

类别	参数	类别	参数
额定功率 Rated Power	5W	光源 / 数量 LED Quantity	LED / 24pcs
色温 Color Temperature	3000K / 4000K / 5700K	50%光束角 50% Beam Angle	A: B: 100° / C: 50x100°
使用寿命 Life	>30000H	防护等级 Protection Grade	IP 65
灯具净重 Net Weight	2kg	中包规格 Package Specification	270x110x130mm
		输入电压 Input Voltage	DC 24V / AC 220V
		控制方式 Control Mode	ON-OFF
		工作环境温度 Temperature of Working Condition	-25°C~50°C
		外箱规格 / 数量 Outside Box Specifications / Quantity	350x290x280mm / 6pcs



颜色选择 Color Selection

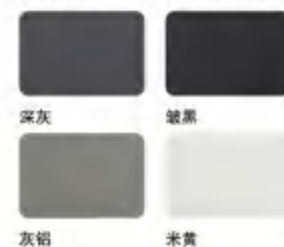

产品尺寸 Product Size

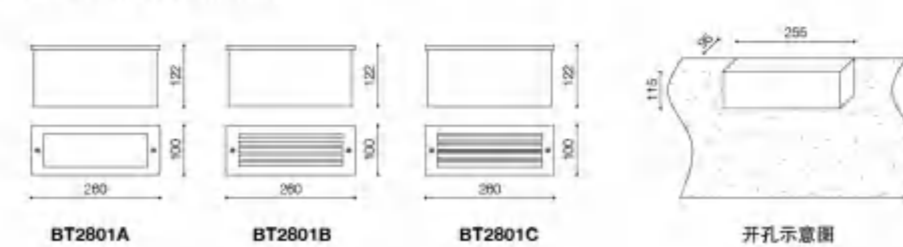

BT2932A

专利设计 DESIGN PATENT



BT2933A

专利设计 DESIGN PATENT



适用场合

主要应用于室内装饰、户外走廊、庭院等。

The Application of Occasions

Suitable places: Interior decoration, Outdoor corridor, Garden etc.

产品特点说明

1. 灯体主体采用高强度压铸铝，表面采用静电喷塑处理，防腐蚀、抗老化、延长使用寿命。
2. 透光罩采用钢化磨砂玻璃，使得光线更加均匀柔和。
3. 灵活的二次光学透镜配光，根据实际需要多种光束角选择。
4. 独立的电源腔体并采用高效率、高稳定性恒流驱动电源，保证了光源的稳定工作，降低光衰，延长使用寿命。
5. 灯体表面设计了纵向散热片有利于通风，增加散热面积，迅速散热，升华了灯具的整体美观程度。
6. 采用硅橡胶密封结构设计，有效保证了防护等级IP54。
7. 安装采用塑料预埋件，使得安装方便。

Product Description

1. Aluminium die-cast body, coated with outdoor used powder, double anti-corrosion to ensure 8 years long-life span.
2. Frosted tempered glass diffuser, make the light downy and eveness.
3. Flexible optical lens design, multiple beam angle to satisfy the different requests.
4. Independent power supply recessed design, using high efficiency and stability constant current driver to extend working life.
5. Axial heat sink design on light body surface, increase the efficiency of heat-dissipation and improve the aesthetic measure of lanterns.
6. Using silicone rubber leakproof structure design to ensure the high level of IP rating(IP:54).
7. Plastic recessed housing included.



下斜式出光，防止眩光。
A type of light, to prevent glare.



整体注塑预埋桶，便于安装维护。
Plastic recessed housing, convenient for installation and maintainance.



配光曲线 Light Distribution Curve

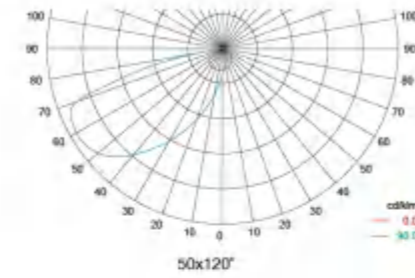

等照度图 Illumination Map

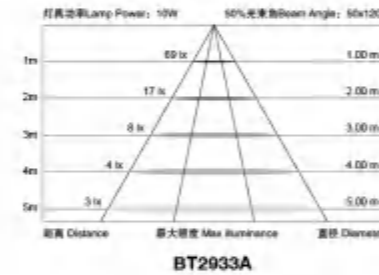
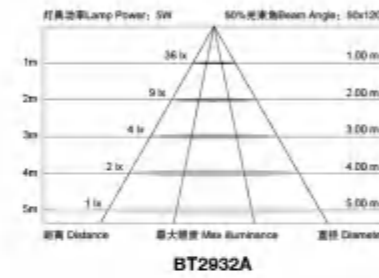

颜色选择 Color Selection

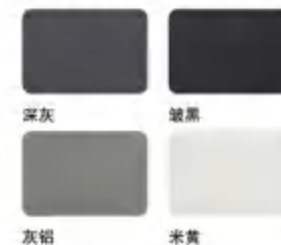

产品尺寸 Product Size

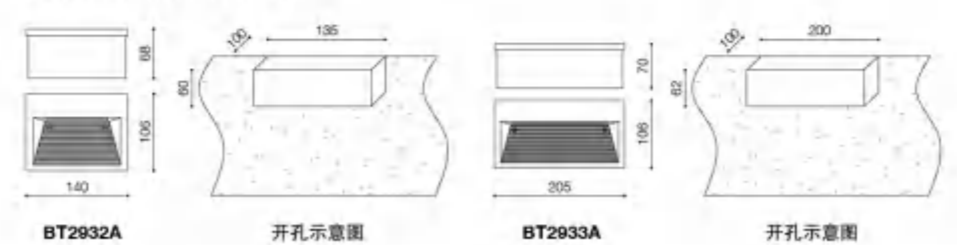

技术参数 Specification

类别	Product Code	参数 Parameter	
		BT2932A	BT2933A
额定功率	Rated Power	5W	10W
光源 / 数量	LED Quantity	LED / 24pcs	LED / 40pcs
输入电压	Input Voltage	DC 24V / AC 220V	
色温	Color Temperature	3000K / 4000K / 5700K	
50%光束角	50% Beam Angle	50°x120°	
控制方式	Control Mode	ON-OFF	
使用寿命	Life	>30000H	
防护等级	Protection Grade	IP 54	
工作环境温度	Temperature of Working Condition	-25°C-50°C	
灯具净重	Net Weight	0.5kg	0.8kg
中包规格	Package Specification	150x115x85mm	215x115x85mm
外箱规格 / 数量	Outside Box Specifications / Quantity	480x320x280mm/24pcs	450x365x200mm/12pcs



BT1083MA

专利号 Num: 201130120912.X

BT1083MB

专利号 Num: 201130120914.9



适用场合

主要应用于室内装饰、户外走廊、庭院等。

The Application of Occasions

Suitable places: Interior decoration, Outdoor corridor, Garden etc.

产品特点说明

1. 经典的工业设计造型，美学与实用的完美结合，外观和结构专利。
2. 灯体主体部分采用高压压铸铝和铝合金型材，表面双层静电喷塑处理，防腐性、抗老化，延长使用寿命。
3. 透光罩采用钢化超白玻璃，更有效的提高了光的透射率。
4. 采用光学透镜二次配光，根据实际应用可选择透镜角度。
5. 采用高效率、高稳定性恒流驱动电源，保证了光源的稳定工作，降低光衰，延长使用寿命。
6. 灯体表面设计了散热片，增加散热面积，迅速散热，升华了灯具的整体美观程度。
7. 独立的电源腔体设计，有效的保证了电源的散热，延长电源使用寿命。
8. 安装采用高压压铸铝底座和金属底盘配合使用，安装简便。
9. 采用硅橡胶密封结构设计，有效保证了防护等级IP65。

Product Description

1. Classical industrial design, Perfect aesthetic and practical union, patented appearance and structure technology.
2. Aluminium die-cast body, coated with outdoor used powder, double anti-corrosion to extend service life.
3. Ultrawhite tempered glass diffuser, effectively improve the transmission rate of light.
4. Scientific optical lens design, with different lens angle choice.
5. High efficiency constant current driver, ensure the light source is maximum used.
6. Heat sink design on light body surface, increase the efficiency of heat-dissipation.
7. Independent power supply recessed design, extend the power supply working life.
8. Using high pressure aluminium die-cast base and metal chassis installation.
9. Using silicone rubber leakproof structure design to ensure the high level of IP rating (IP65).



二次光学透镜配光，多种角度选择。
Scientific optical lens with different beam angle choice.



敞开式散热片，提高散热效果。
Open-type heat sink, improve heat dissipation efficiency.



配光曲线 Light Distribution Curve

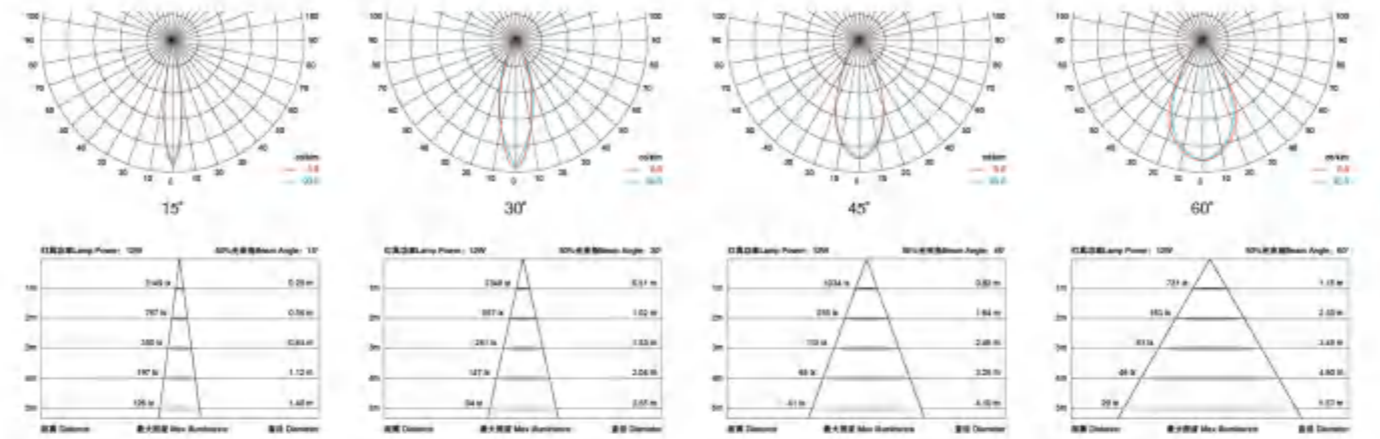

技术参数 Specification

参数	BT1083MA	BT1083MB	参数	BT1083MA	BT1083MB	参数	BT1083MA	BT1083MB	
额定功率 Rated Power	12W	24W	光源 / 数量 LED Quantity	LED / 9pcs	LED / 18pcs	输入电压 Input Voltage	DC 24V / AC 220V		
色温 Color Temperature	3000K / 4000K / 5700K		50%光束角 50% Beam Angle	15° 30° 45° 60°	控制方式 Control Mode	ON-OFF			
使用寿命 Life	>30000H		防护等级 Protection Grade	IP 65		工作环境温度 Temperature of Working Condition	-25°C~50°C		
灯具净重 Net Weight	2.5kg	3.5kg	中包规格 Package Specification	290x190x210mm	340x210x180mm	外箱规格 / 数量 Outside Box Specifications / Quantity	400x310x140mm / 4pcs	440x360x137mm / 4pcs	

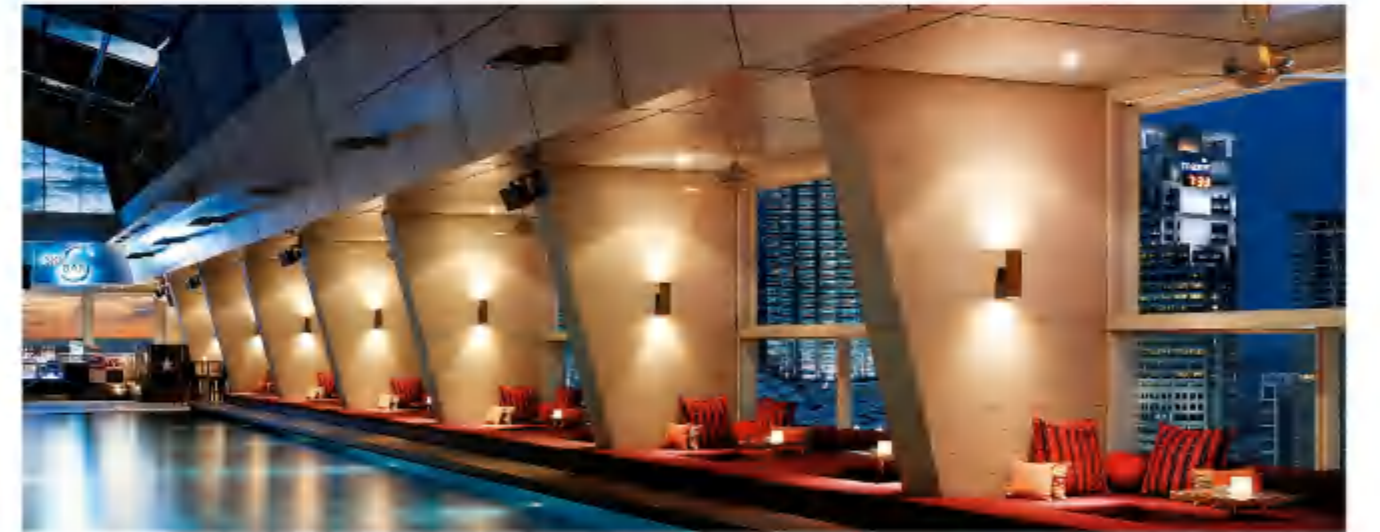

颜色选择 Color Selection

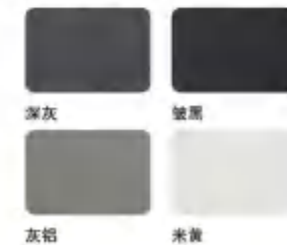

产品尺寸 Product Size

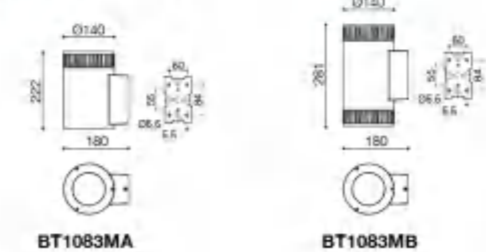

BT3444 UP-LED8

专利号 Num: 201130120926.1
201020168920.1

BT3444 UP-E27

专利号 Num: 201130120926.1
201020168920.1



适用场合

主要应用于室内装饰、户外走廊、庭院等。

The Application of Occasions

Suitable places: Interior decoration, Outdoor corridor, Garden etc.

产品特点说明

1. 经典的工业设计造型, 美学与实用的完美结合, 外观和结构专利。
2. 灯体主体部分采用高压压铸铝, 表面静电喷塑处理, 防腐蚀、抗老化, 延长使用寿命。
3. 反射器采用进口镜面铝板, 冲压成型, 提高了光的利用率。
4. 透光罩采用压制磨砂玻璃, 抗老化、防紫外线。
5. 整体头部与灯杆连接外表无螺钉出现, 巧妙的结构设计, 增强整体美感。
6. 安装采用高压压铸铝挂角和金属底盘配合使用, 安装简洁方便。
7. 采用硅橡胶密封结构设计, 有效保证了防护等级IP65。

Product Description

1. Classical industrial design, Perfect aesthetic and practical union, patented appearance and structure technology.
2. High pressure Aluminium die-cast housing, coated with outdoor used powder, double anti-corrosion to extend service life.
3. Stamping mirror-plane aluminium reflector, improve the transmission rate of light.
4. Frosted pressing glass diffuser, aging resistant, Uv-stabilized.
5. Overall the head and body without bolt connection, clever structure design, enhance overall aesthetic feeling.
6. Using Aluminium die-cast base and metal chassis installation.
7. Using silicone rubber leakproof structure design to ensure the high level of IP rating (IP-65).



整体压制磨砂玻璃罩。
Frosted glass diffuser.



进口纯铝反光片。
Imported aluminium reflector.



配光曲线 Light Distribution Curve

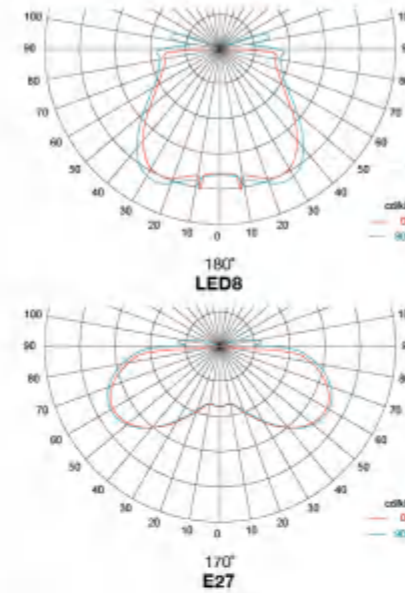

等照度图 Illumination Map

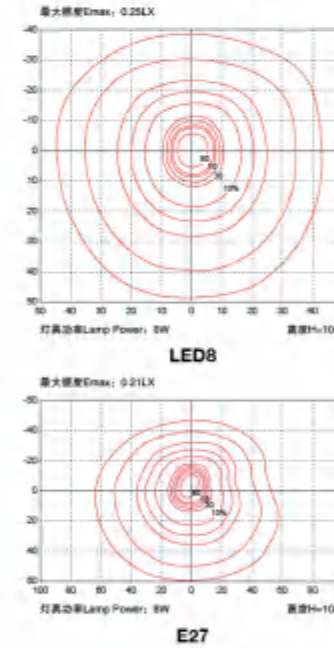

颜色选择 Color Selection

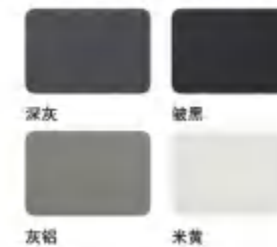

技术参数 Specification

类别	Product Code	参数 Parameter	
		LED8	E27
额定功率	Rated Power	8W	8W
光源 / 数量	LED Quantity	LED / 8pcs	E27 / 1pcs
输入电压	Input Voltage	DC 24V / AC 220V	
色温	Color Temperature	3000K / 4000K / 5700K	
50%光束角	50% Beam Angle	180°	170°
控制方式	Control Mode	ON-OFF	
使用寿命	Life	>30000H	
防护等级	Protection Grade	IP 65	
工作环境温度	Temperature of Working Condition	-25°C-50°C	
灯具净重	Net Weight	3.5kg	6.5kg
中包规格	Package Specification	--	
外箱规格 / 数量	Outside Box Specifications / Quantity	370x400x400mm / 1pcs	



产品尺寸 Product Size

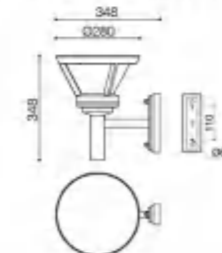

S0090UP

专利号 Num: 201230154189.1



整体压制二次配光玻璃罩。
Pressing glass diffuser.



敞开式散热片, 提高散热效果。
Open-type heat sink, improve heat dissipation efficiency.



整体压铸安装底座。
Aluminium die-cast mounting base.



紧定螺钉固定, 提升整体外观。
Screw fixed, improve overall appearance.

适用场合

主要应用于室内装饰、户外走廊、庭院等。

The Application of Occasions

Suitable places: Interior decoration, Outdoor corridor, Garden etc.

产品特点说明

1. 经典的工业设计造型来自于海滩贝壳, 美学与实用的完美结合, 外观和结构专利。
2. 灯体主体部分采用高压压铸铝, 表面双层静电喷塑处理, 防腐性、抗老化, 保证8年以上的使用寿命。
3. 透光罩采用压制玻璃, 融入科学的二次配光设计技术和美学的设计理念, 提高了灯具整体的美观程度和使用性能。
4. 采用高效率、高稳定性恒流驱动电源, 保证了光源的稳定工作, 降低光衰, 延长使用寿命。
5. 灯体表面设计了纵向散热片有利于通风, 增加散热面积, 迅速散热, 升华了灯具的整体美观程度, 同时有利于去雨雾和灰尘, 提高了灯具的自洁能力。
6. 采用硅橡胶密封结构设计, 有效保证了防护等级IP65。
7. 安装采用高压压铸铝安装底座, 使得安装方便牢固。

Product Description

1. Design concept from the beach shells shape, Perfect aesthetic and practical union, patented appearance and structure technology.
2. High pressure Aluminium die-cast housing, coated with outdoor used powder, double anti-corrosion to ensure 8 year long-life span.
3. Pressing glass diffuser, effectively improve the transmission rate of light.
4. High efficiency constant current driver, ensure the light source is maximum used.
5. Axial heat sink design on light body surface, increase the efficiency of heat-dissipation.
6. Using silicone rubber leakproof structure design to ensure the high level of IP rating (IP65).
7. Combined high pressure aluminium die-cast base, make the installation simple and firm.



配光曲线 Light Distribution Curve

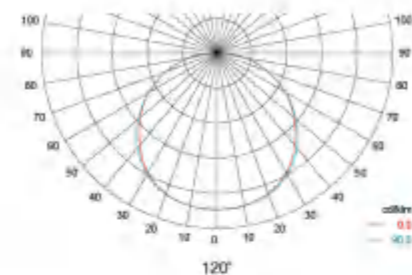

等照度图 Illumination Map

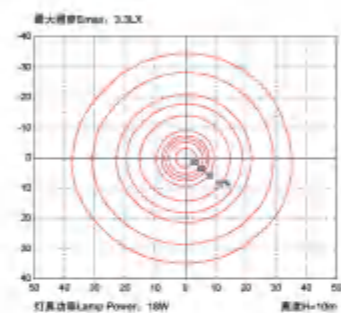

散热模拟图 Thermal Simulation Figure

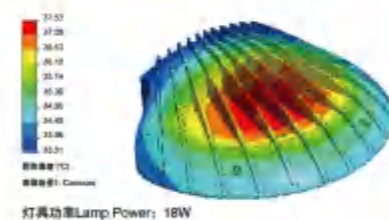

颜色选择 Color Selection

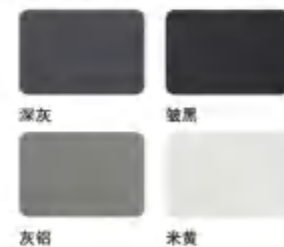

产品尺寸 Product Size

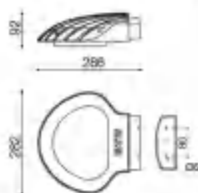

技术参数 Specification

类别	Product Code	参数 Parameter
额定功率	Rated Power	18W
光源 / 数量	LED Quantity	LED / 18pcs
输入电压	Input Voltage	DC 24V / AC 220V
色温	Color Temperature	3000K / 4000K / 5700K
50%光束角	50% Beam Angle	120°
控制方式	Control Mode	ON-OFF
使用寿命	Life	>30000H
防护等级	Protection Grade	IP 65
工作环境温度	Temperature of Working Condition	-25°C~50°C
灯具净重	Net Weight	2.5kg
中包规格	Package Specification	295x295x120mm
外箱规格 / 数量	Outside Box Specifications / Quantity	610x320x390mm / 6pcs

BT3444 H1-LED8

专利号 Num: 201030159027.8
201020168920.1



BT3444 H1-E27

专利号 Num: 201030159027.8
201020168920.1



适用场合

主要应用于草坪、花园、公园、小区道路等。

The Application of Occasions

Suitable places: Lawn, Garden, Park etc.

产品特点说明

1. 高压压铸铝成型外壳，表面抗老化静电喷塑处理。
2. 双层防腐处理，保证8年以上使用的寿命。
3. 透光罩采用压铸磨砂玻璃，抗老化、防紫外线；防护等级可达IP54，较传统草坪灯更优越。
4. 光源可采用金卤灯、E27节能灯、大功率LED光源。
5. 内部配置可移动灯头安装支架，保证光源的出光效果。
6. 整体头部和灯体连接，外表面无螺钉出现，增加整体的美观程度。
7. 采用铝压铸法兰底座安装方式。

Product Description

1. Aluminium die-cast body, Anti-Static surface, the housing is coated with outdoor used powder, aging resistant.
2. Double anti-corrosion to ensure 8 year long-life span.
3. Frosted glass diffuser, aging resistant, UV-protect; Protection level: IP54.
4. Using Mh, E27, high power LED as the light source.
5. Internal layout install movable bracket, guarantee the effect of light.
6. The overall head connects the body.
7. Using Aluminium die-cast flange base installation.



整体压铸磨砂玻璃罩。
Frosted glass diffuser.



进口纯铝反光片。
Imported aluminium reflector.



配光曲线 Light Distribution Curve

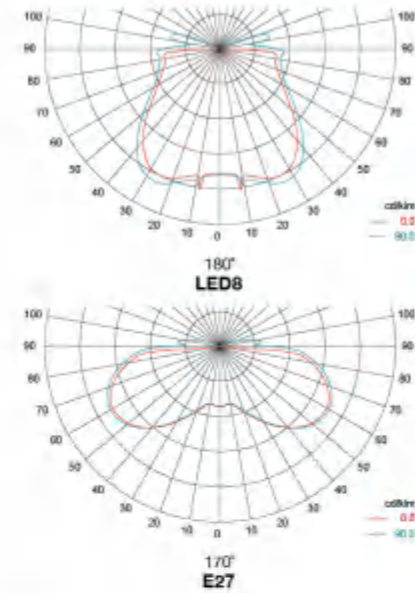

等照度图 Illumination Map

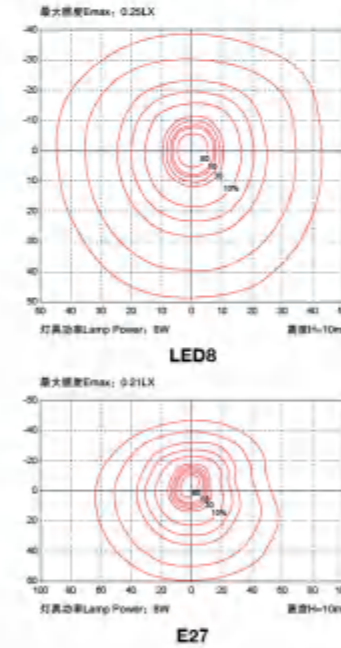

颜色选择 Color Selection

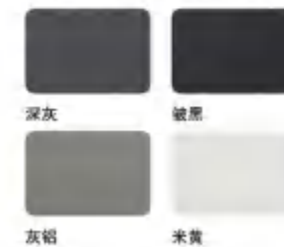

技术参数 Specification

类别	Product Code	参 数 Parameter	
		LED8	E27
额定功率	Rated Power	8W	8W
光源 / 数量	LED Quantity	LED / 8pcs	E27 / 1pcs
输入电压	Input Voltage	AC 220V	
色温	Color Temperature	3000K / 4000K / 5700K	
50%光束角	50% Beam Angle	180°	170°
控制方式	Control Mode	ON-OFF	
使用寿命	Life	>30000H	
防护等级	Protection Grade	IP 54	
工作环境温度	Temperature of Working Condition	-25°C~50°C	
灯具净重	Net Weight	6.5kg	
中包规格	Package Specification	--	
外箱规格 / 数量	Outside Box Specifications / Quantity	370x370x1040mm / 1pcs	



产品尺寸 Product Size

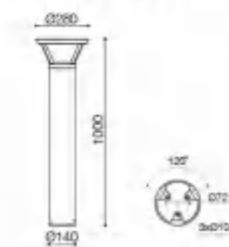

BT3501

专利号 Num: 201230154186.8



模块可旋转调节照射角度。
Rotatable modules, can adjust the beam angle with request.



敞开式散热片, 提高散热效果。
Open-type heat sink, improve heat dissipation efficiency.



整体压铸灯杆安装连接套。
Aluminium die-cast pole connector.



特制型材灯杆, 提升整灯档次。
Custom-make alloy pole, increase the lamp grade.

适用场合

主要应用于草坪、花园、公园、小区道路等。

The Application of Occasions

Suitable places: Lawn, Garden, Park etc.

产品特点说明

1. 极简的工业设计造型, 美学与实用的完美结合, 外观和结构专利。
2. 灯体主体部分采用高压压铸铝, 表面双层静电喷塑处理, 防腐蚀、抗老化, 保证8年以上的使用寿命。
3. 透光罩采用丝印钢化玻璃, 提高了灯具整体的美观程度, 灵活的二次光学透镜配光, 根据实际需要多种光束角选择。
4. 独立的电源腔体并采用高效率、高稳定性恒流驱动电源, 保证了光源的稳定工作, 降低光衰, 延长使用寿命。
5. 采用硅橡胶密封结构设计, 有效保证了防护等级IP65。
6. 安装采用高压压铸铝接套和铝合金型材灯杆配套使用, 使得安装方便牢固。

Product Description

1. Simple and practical design, Perfect aesthetic and practical union, patented appearance and structure technology.
2. High pressure Aluminium die-cast housing, coated with outdoor used powder, double anti-corrosion to ensure 8 year long-life span.
3. Tempered glass diffuser, effectively improve the transmission rate of light. Multiple Beam-angle choice.
4. High efficiency constant current driver, ensure the light source is maximum used.
5. Axial heat sink design on light body surface, increase the efficiency of heat-dissipation. Rotatable Independent Module design, adjust the light angle accordingly.
6. Using silicone rubber leakproof structure design to ensure the high level of IP rating (IP-65).



配光曲线 Light Distribution Curve

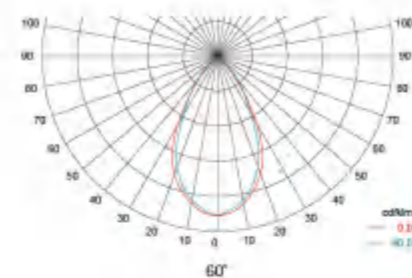

等照度图 Illumination Map

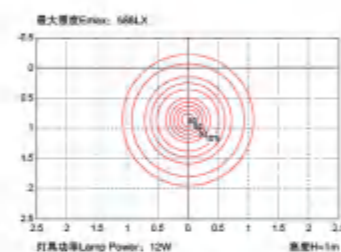

散热模拟图 Thermal Simulation Figure

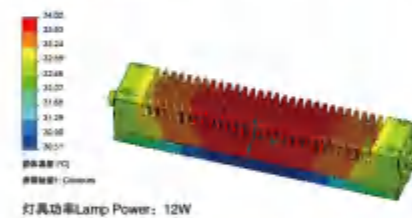

颜色选择 Color Selection

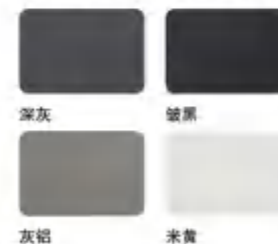

产品尺寸 Product Size

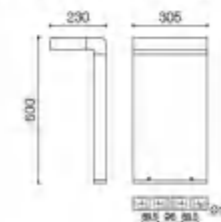

技术参数 Specification

类别	Product Code	参数 Parameter
额定功率	Rated Power	12W
光源 / 数量	LED Quantity	LED / 6pcs
输入电压	Input Voltage	AC 220V
色温	Color Temperature	3000K / 4000K / 5700K
50%光束角	50% Beam Angle	60°
控制方式	Control Mode	ON-OFF
使用寿命	Life	>30000H
防护等级	Protection Grade	IP 65
工作环境温度	Temperature of Working Condition	-25°C~50°C
灯具净重	Net Weight	7kg
中包规格	Package Specification	---
外箱规格 / 数量	Outside Box Specifications / Quantity	620x325x280mm / 1pcs

BTC-13A

专利设计 DESIGN PATENT



适用场合

主要应用于草坪、花园、公园、小区道路等。

The Application of Occasions

Suitable places: Lawn, Garden, Park etc.

产品特点说明

1. 经典的工业设计造型，美学与实用的完美结合。
2. 灯体采用铝合金管材和高强度压铸铝，表面抗老化静电喷塑处理。
3. 透光罩采用进口PC材质或磨砂钢化玻璃。
4. 二次配光设计，更好的实现光优化。
5. 法兰式安装结构，便于施工安装。
6. 采用硅橡胶结构设计，有效保证防护等级。

Product Description

1. The classic industrial design, the perfect combination of aesthetic and practical.
2. The lamp body is made of Aluminum Alloy pipe and high strength casting aluminum, anti aging surface electrostatic spray processing.
3. Transparent cover adopts imported PC material or frosted tempered glass.
4. The two light distribution design, better light optimization.
5. Flange type installation structure, convenient construction and installation.
6. The use of silicone rubber structure design, effective protection level.



整体注塑加厚透明PC罩。
Thickened transparent PC diffuser.



加厚灯杆，表面特种工艺处理。
Thickened pole, special processing on the surface.



配光曲线 Light Distribution Curve

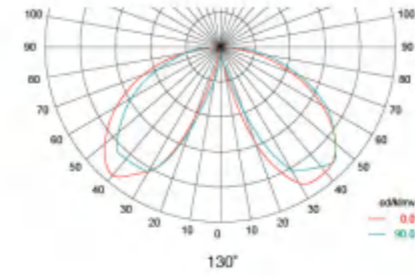

等照度图 Illumination Map

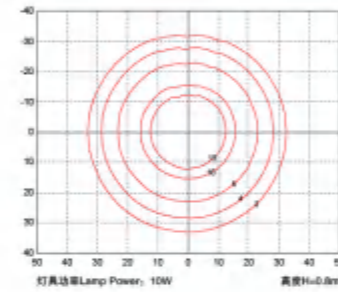

颜色选择 Color Selection

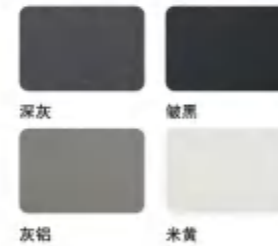

产品尺寸 Product Size

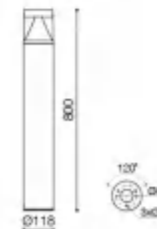

技术参数 Specification

类别	Product Code	参数 Parameter
额定功率	Rated Power	10W
光源 / 数量	LED Quantity	LED / 42pcs
输入电压	Input Voltage	AC 220V
色温	Color Temperature	3000K / 4000K / 5700K
50%光束角	50% Beam Angle	130°
控制方式	Control Mode	ON-OFF
使用寿命	Life	>30000H
防护等级	Protection Grade	IP 65
工作环境温度	Temperature of Working Condition	-25°C~50°C
灯具净重	Net Weight	2.8kg
中包规格	Package Specification	135x135x820mm
外箱规格 / 数量	Outside Box Specifications / Quantity	835x280x285mm / 4pcs

BTC-13BS

专利设计 DESIGN PATENT



适用场合

主要应用于草坪、花园、公园、小区道路等。

The Application of Occasions

Suitable places: Lawn, Garden, Park etc.

产品特点说明

1. 经典的工业设计造型，美学与实用的完美结合。
2. 灯体采用铝合金管材和高强度压铸铝，表面抗老化静电喷塑处理。
3. 透光罩采用进口PC材质或磨砂钢化玻璃。
4. 二次配光设计，更好的实现光优化。
5. 法兰式安装结构，便于施工安装。
6. 采用硅橡胶结构设计，有效保证防护等级。

Product Description

1. The classic industrial design, the perfect combination of aesthetic and practical.
2. The lamp body is made of Aluminum Alloy pipe and high strength casting aluminum, anti aging surface electrostatic spray processing.
3. Transparent cover adopts imported PC material or frosted tempered glass.
4. The two light distribution design, better light optimization.
5. Flange type installation structure, convenient construction and installation.
6. The use of silicone rubber structure design, effective protection level.

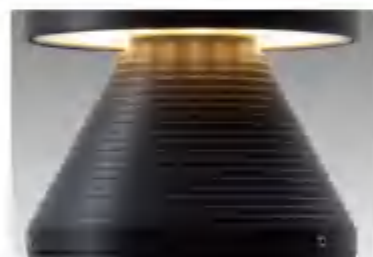

二次配光结构设计。
Two times light distribution structure design.



加厚灯杆，表面特种工艺处理。
Thickened pole, special processing on the surface.



配光曲线 Light Distribution Curve

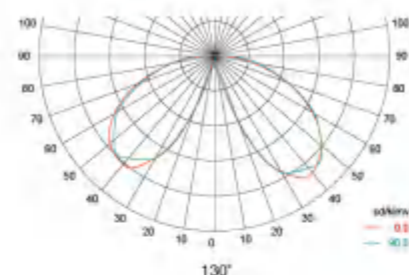

等照度图 Illumination Map

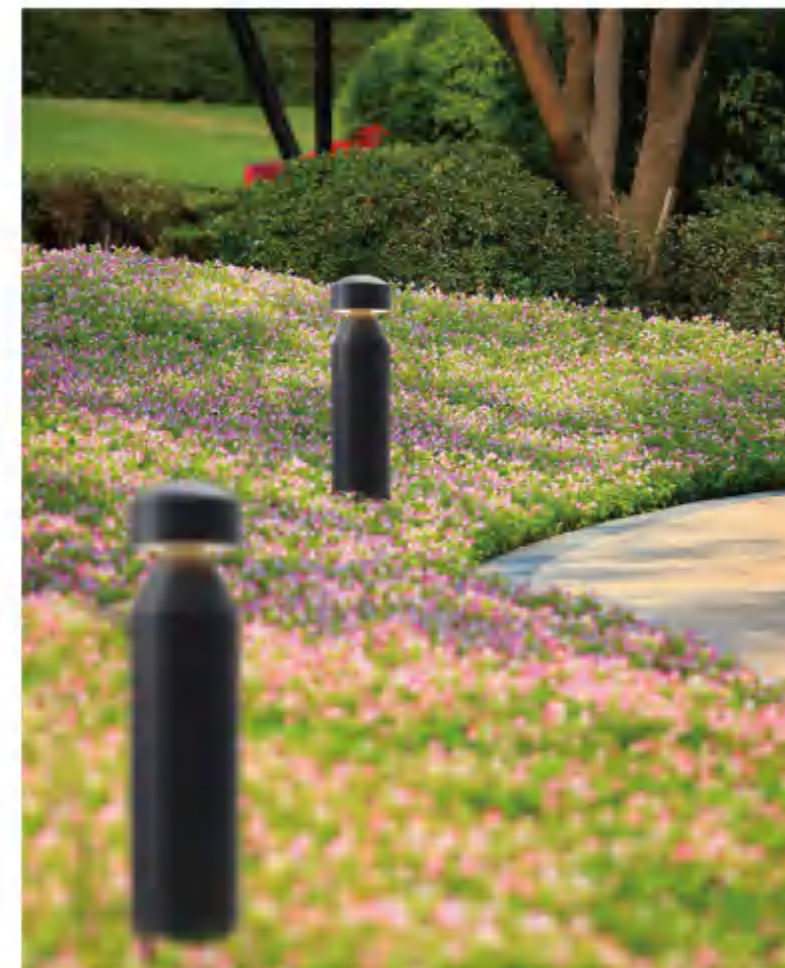
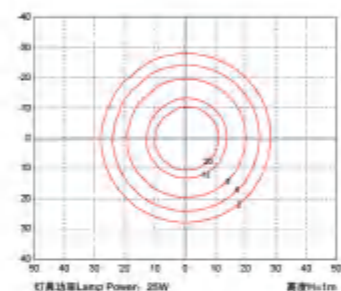

颜色选择 Color Selection

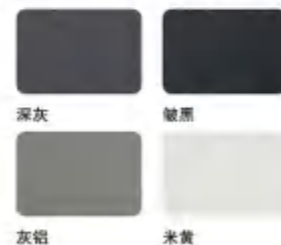

产品尺寸 Product Size

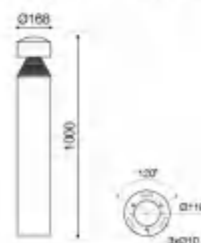

技术参数 Specification

类别	Product Code	参数 Parameter
额定功率	Rated Power	25W
光源 / 数量	LED Quantity	LED / 54pcs
输入电压	Input Voltage	AC 220V
色温	Color Temperature	3000K / 4000K / 5700K
50%光束角	50% Beam Angle	130°
控制方式	Control Mode	ON-OFF
使用寿命	Life	>30000H
防护等级	Protection Grade	IP 65
工作环境温度	Temperature of Working Condition	-25°C~50°C
灯具净重	Net Weight	6kg
中包规格	Package Specification	---
外箱规格 / 数量	Outside Box Specifications / Quantity	1030x235x240mm / 1pcs

BTC-14 Series

专利设计 DESIGN PATENT



适用场合

主要应用于草坪、花园、公园、小区道路等。

The Application of Occasions

Suitable places: Lawn, Garden, Park etc.

产品特点说明

1. 经典的工业设计造型，美学与实用的完美结合。
2. 灯体采用铝合金管材和高强度压铸铝，表面抗老化静电喷塑处理。
3. 透光罩采用进口PC材质或磨砂钢化玻璃。
4. 二次配光设计，更好的实现光优化。
5. 法兰式安装结构，便于施工安装。
6. 采用硅橡胶结构设计，有效保证防护等级。

Product Description

1. The classic industrial design, the perfect combination of aesthetic and practical.
2. The lamp body is made of Aluminum Alloy pipe and high strength casting aluminum, anti aging surface electrostatic spray processing.
3. Transparent cover adopts imported PC material or frosted tempered glass.
4. The two light distribution design, better light optimization.
5. Flange type installation structure, convenient construction and installation.
6. The use of silicone rubber structure design, effective protection level.



整体注塑加厚透明PC罩。
Thickened transparent PC diffuser.



加厚灯杆，表面特种工艺处理。
Thickened pole, special processing on the surface.



配光曲线 Light Distribution Curve

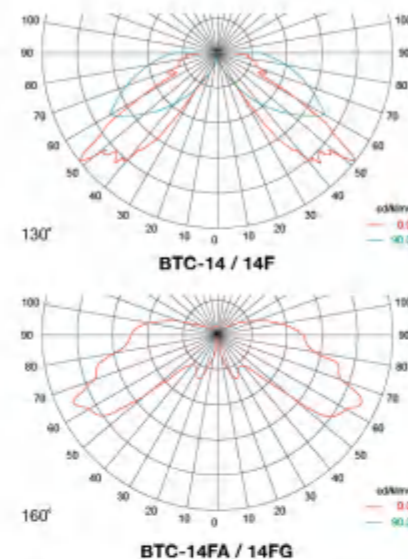

等照度图 Illumination Map

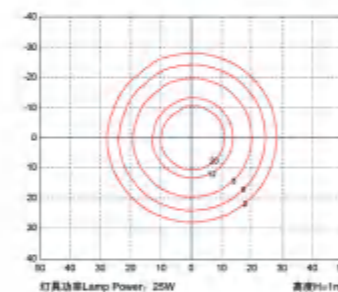

颜色选择 Color Selection

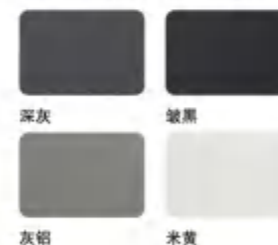

产品尺寸 Product Size

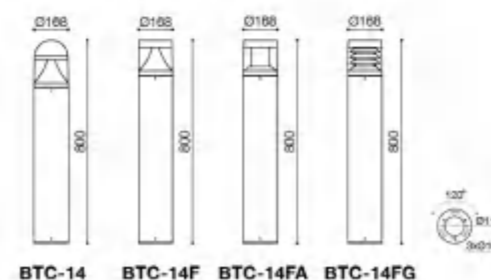

技术参数 Specification

类别	Product Code	参数 Parameter	
		BTC-14 / 14F	BTC-14FA / 14FG
额定功率	Rated Power	25W	25W
光源 / 数量	LED Quantity	LED / 132pcs	LED / 144pcs
输入电压	Input Voltage	AC 220V	
色温	Color Temperature	3000K / 4000K / 5700K	
50%光束角	50% Beam Angle	130°	160°
控制方式	Control Mode	ON-OFF	
使用寿命	Life	>30000H	
防护等级	Protection Grade	IP 65	
工作环境温度	Temperature of Working Condition	-25°C~50°C	
灯具净重	Net Weight	5kg	5.8kg
中包规格	Package Specification	175x175x820mm	
外箱规格 / 数量	Outside Box Specifications / Quantity	835x365x190mm / 2pcs	

BTC-162 Series

专利设计 DESIGN PATENT



BTC-162S

BTC-162M



适用场合

主要应用于草坪、花园、公园、小区道路等。

The Application of Occasions

Suitable places: Lawn, Garden, Park etc.

产品特点说明

1. 经典的工业设计造型，美学与实用的完美结合。
2. 灯体采用铝合金管材和高强度压铸铝，表面抗老化静电喷塑处理。
3. 透光罩采用进口PC材质或磨砂钢化玻璃。
4. 二次配光设计，更好的实现光优化。
5. 法兰式安装结构，便于施工安装。
6. 采用硅橡胶结构设计，有效保证防护等级。



整体注塑加厚透明PC罩。

Thickened transparent PC diffuser.



加厚灯杆，表面特种工艺处理。

Thickened pole, special processing on the surface.

Product Description

1. The classic industrial design, the perfect combination of aesthetic and practical.
2. The lamp body is made of Aluminum Alloy pipe and high strength casting aluminum, anti aging surface electrostatic spray processing.
3. Transparent cover adopts imported PC material or frosted tempered glass.
4. The two light distribution design, better light optimization.
5. Flange type installation structure, convenient construction and installation.
6. The use of silicone rubber structure design, effective protection level.



配光曲线 Light Distribution Curve

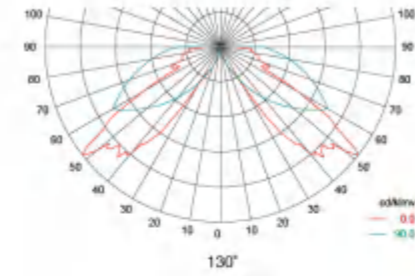

等照度图 Illumination Map

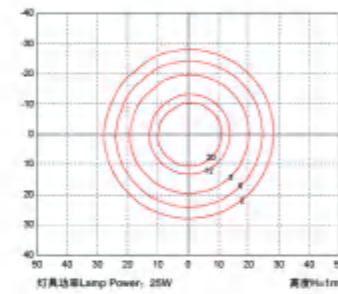

颜色选择 Color Selection

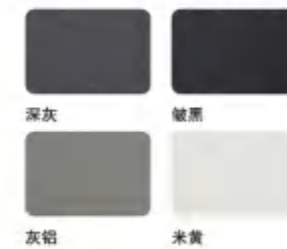

产品尺寸 Product Size

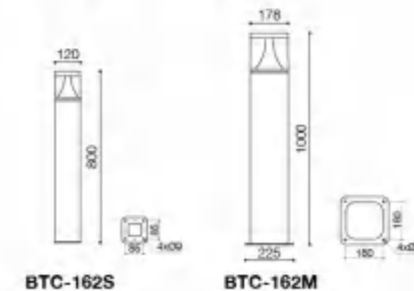

技术参数 Specification

类别	Product Code	参数 Parameter	
		BTC-162S	BTC-162M
额定功率	Rated Power	12W	25W
光源 / 数量	LED Quantity	LED / 132pcs	LED / 168pcs
输入电压	Input Voltage	AC 220V	
色温	Color Temperature	3000K / 4000K / 5700K	
50%光束角	50% Beam Angle	130°	
控制方式	Control Mode	ON-OFF	
使用寿命	Life	>30000H	
防护等级	Protection Grade	IP 65	
工作环境温度	Temperature of Working Condition	-25°C~50°C	
灯具净重	Net Weight	3.2kg	8.5kg
中包规格	Package Specification	135x135x82mm	---
外箱规格 / 数量	Outside Box Specifications / Quantity	835x280x285mm/4pcs	1030x235x235mm/1pcs

BT3428B

专利号 Num: 201030139613.6



BT3428F

专利设计 DESIGN PATENT



配光曲线 Light Distribution Curve

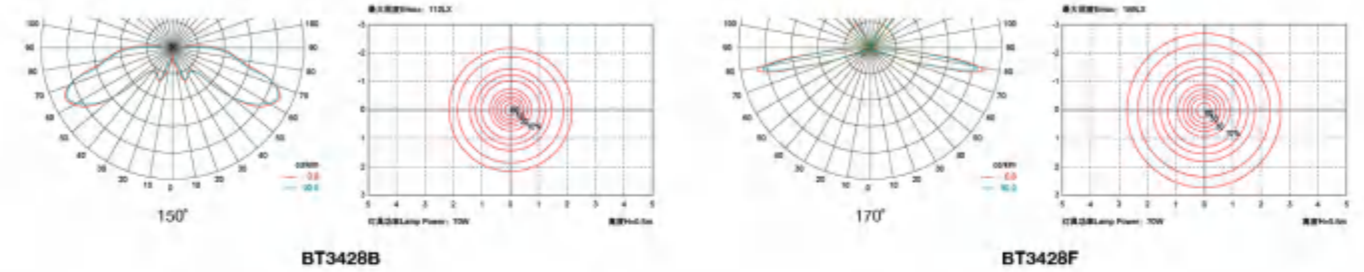

技术参数 Specification

类别	参数	类别	参数	类别	参数		
	BT3428B	BT3428F	BT3428B	BT3428F	BT3428B / BT3428F		
额定功率 Rated Power	70W		光源 / 数量 Light Source / Quantity	E27 / 1pcs / G12 / 1pcs	输入电压 Input Voltage	AC 220V	
色温 Color Temperature	3000K / 4200K		50%光束角 50% Beam Angle	150° / 170°	控制方式 Control Mode	ON-OFF	
使用寿命 Life	>30000H		防护等级 Protection Grade	IP 54		工作环境温度 Temperature of Working Condition	-25°C~50°C
灯具净重 Net Weight	15.5kg	14kg	中包规格 Package Specification	---			
					外箱规格 / 数量 Outside Box Specifications / Quantity	106x250x250mm / 1pcs	

适用场合

主要应用于草坪、花园、公园、小区道路等。

The Application of Occasions

Suitable places: Lawn, Garden, Park etc.

产品特点说明

1. 经典的工业设计造型，美学与实用的完美结合。
2. 灯体采用铝合金管材和高强度压铸铝，表面抗老化静电喷塑处理。
3. 透光罩采用进口PC材质或磨砂钢化玻璃。
4. 二次配光设计，更好的实现光优化。
5. 法兰式安装结构，便于施工安装。
6. 采用硅橡胶结构设计，有效保证防护等级。

Product Description

1. The classic industrial design, the perfect combination of aesthetic and practical.
2. The lamp body is made of Aluminum Alloy pipe and high strength casting aluminum, anti aging surface electrostatic spray processing.
3. Transparent cover adopts imported PC material or frosted tempered glass.
4. The two light distribution design, better light optimization.
5. Flange type installation structure, convenient construction and installation.
6. The use of silicone rubber structure design, effective protection level.



整体注塑加厚透明PC罩。
Thickened transparent PC diffuser.



加厚灯杆，表面特种工艺处理。
Thickened pole, special processing on the surface.

颜色选择 Color Selection

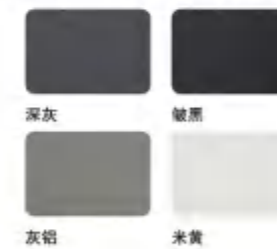

产品尺寸 Product Size

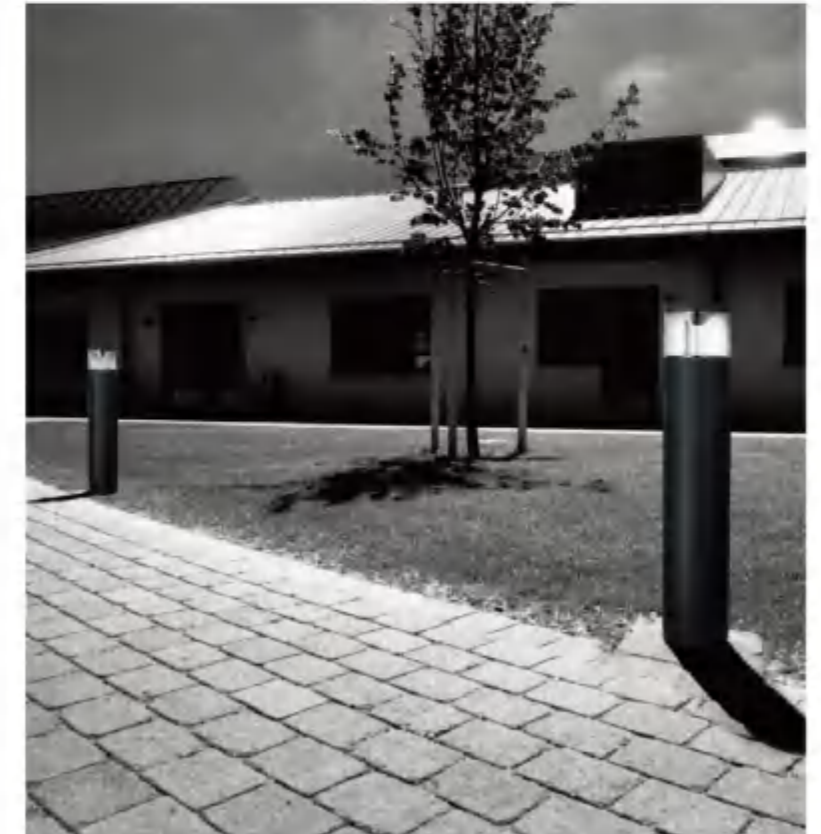
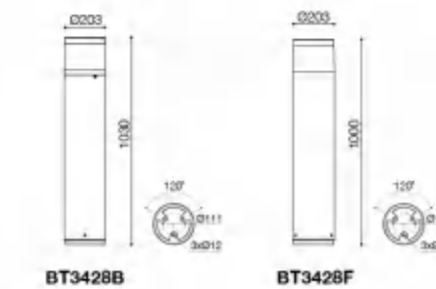

S0106

专利号 Num: 201230154183.4



适用场合

主要应用于庭院、小区、停车场等。

The Application of Occasions

Suitable places: Garden, Housing Estate road, Parking lot etc.

产品特点说明

1. 极简的工业设计造型，美学与实用的完美结合，外观和结构专利。
2. 灯体主体部分采用高压压铸铝，表面双层静电喷塑处理，防腐蚀、抗老化，保证8年以上的使用寿命。
3. 透光罩采用丝印钢化玻璃，提高了灯具整体的美观程度，灵活的二次光学透镜配光，根据实际需要多种光束角选择。
4. 独立的电源腔体并采用高效率、高稳定性恒流驱动电源，保证了光源的稳定工作，降低光衰，延长使用寿命。
5. 采用硅橡胶密封结构设计，有效保证了防护等级IP65。
6. 安装采用高压压铸铝接套和铝合金型材灯杆配套使用，使得安装方便牢固。

Product Description

1. Simple and practical design, Perfect aesthetic and practical union, patented appearance and structure technology.
2. High pressure Aluminium die-cast housing, coated with outdoor used powder, double anti-corrosion to ensure 8 year long-life span.
3. Tempered glass diffuser, effectively improve the transmission rate of light. Multiple Beam-angle choice.
4. High efficiency constant current driver, ensure the light source is maximum used.
5. Using silicone rubber leakproof structure design to ensure the high level of IP rating (IP:65).
6. Connected by high pressure aluminium die-cast joint and aluminium alloy tube, simple installation.



模块式和防水公母插链接。
Modular design and water-proof plug connection.



模块可旋转调节照射角度。
Rotatable modules, can adjust the beam angle with request.



独立的电源腔体，优质硅胶密封。
Independent power supply recessed design with high quality silicone rubber sealing.

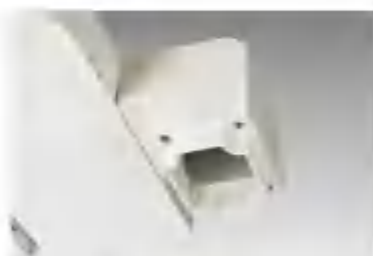

整体压铸灯杆安装连接套。
Aluminium die-cast pole connector.

配光曲线 Light Distribution Curve

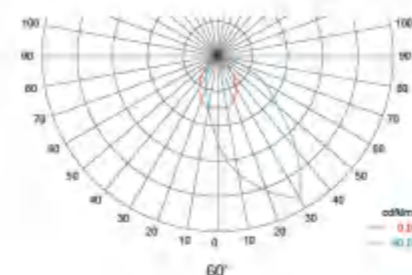

等照度图 Illumination Map

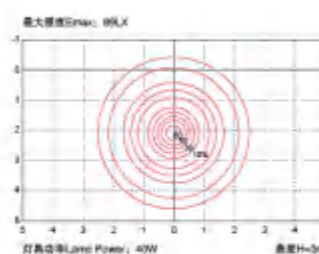

散热模拟图 Thermal Simulation Figure

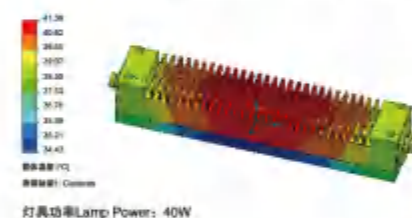

颜色选择 Color Selection

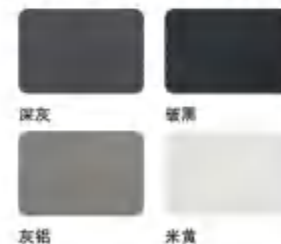

产品尺寸 Product Size

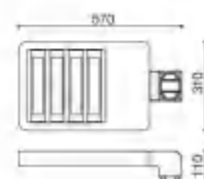

技术参数 Specification

类别	Product Code	参数 Parameter
额定功率	Rated Power	40W
光源 / 数量	LED Quantity	LED / 24pcs
输入电压	Input Voltage	90-305V AC
色温	Color Temperature	3000K / 4000K / 5700K
50%光束角	50% Beam Angle	60°
控制方式	Control Mode	ON-OFF
使用寿命	Life	>30000H
防护等级	Protection Grade	IP 65
工作环境温度	Temperature of Working Condition	-25°C~50°C
灯具净重	Net Weight	7.5kg
中包规格	Package Specification	590x330x130mm
外箱规格 / 数量	Outside Box Specifications / Quantity	610x350x290mm / 2pcs

S0107A

专利号 Num: 201230154190.4

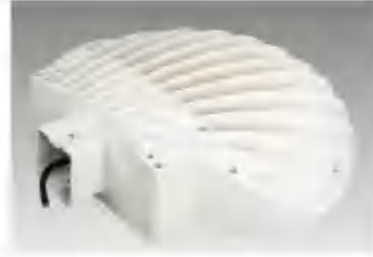

敞开式散热片, 提高散热效果。
Open-type heat sink, improve heat dissipation efficiency.



独立的电源腔体, 优质硅胶密封。
Independent power supply housing with high quality silicone rubber sealing.



整体压铸灯杆安装连接套。
Aluminium die-cast pole connector.

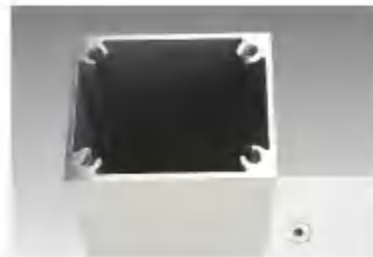

特制型材灯杆, 提升整灯档次。
Custom-make alloy pole, increase the lamp grade.



适用场合

主要应用于庭院、小区、停车场等。

The Application of Occasions

Suitable places: Garden, Housing Estate road, Parking lot etc.

产品特点说明

- 经典的工业设计造型来自于海滩贝壳, 美学与实用的完美结合, 外观和结构专利。
- 灯体主体部分采用高压压铸铝, 表面双层静电喷塑处理, 防腐蚀、抗老化, 保证8年以上的使用寿命。
- 透光罩采用压制玻璃, 融入科学的二次配光设计技术和美学的设计理念, 提高了灯具整体的美观程度和使用性能。
- 采用高效率、高稳定性恒流驱动电源, 保证了光源的稳定工作, 降低光衰, 延长使用寿命。
- 灯体表面设计了纵向散热片有利于通风, 增加散热面积, 迅速散热, 升华了灯具的整体美观程度, 同时有利于去雨雾和灰尘, 提高了灯具的自洁能力。
- 采用硅橡胶密封结构设计, 有效保证了防护等级IP65。
- 安装采用高压压铸铝接套和铝合金型材管配套使用, 使得安装方便牢固。

Product Description

- Design concept from the beach shells shape, Perfect aesthetic and practical union, patented appearance and structure technology.
- High pressure Aluminium die-cast housing, coated with outdoor used powder, double anti-corrosion to ensure 8 year long-life span.
- Pressing glass diffuser, effectively improve the transmission rate of light.
- High efficiency constant current driver, ensure the light source is maximum used.
- Axial heat sink design on light body surface, increase the efficiency of heat-dissipation.
- Using silicone rubber leakproof structure design to ensure the high level of IP rating (IP:65).
- Connected by high pressure aluminium die-cast joint and aluminium alloy tube, simple installation.



配光曲线 Light Distribution Curve

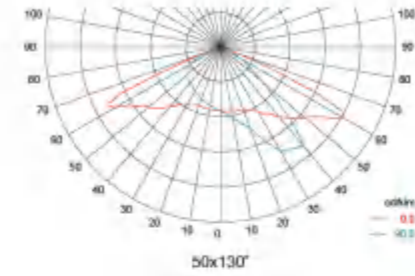

等照度图 Illumination Map

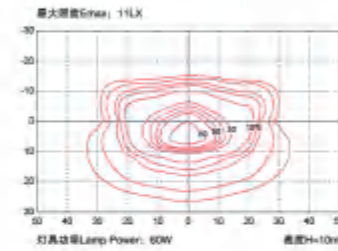

散热模拟图 Thermal Simulation Figure

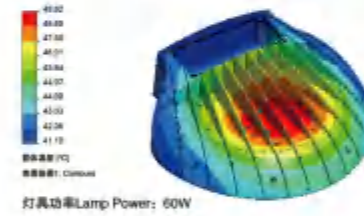

颜色选择 Color Selection

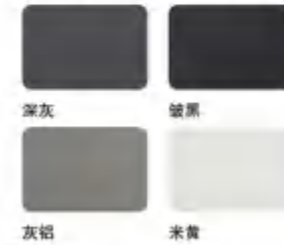

产品尺寸 Product Size

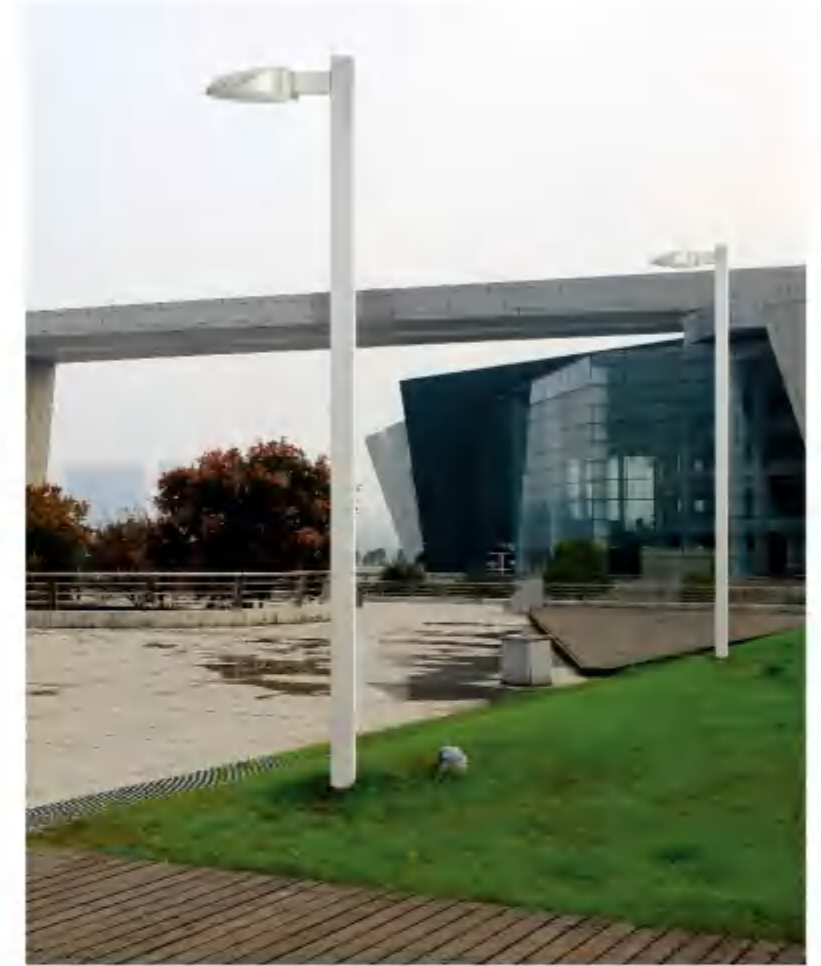
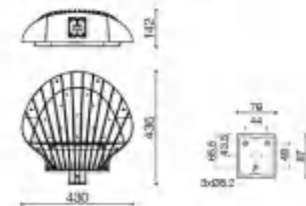

技术参数 Specification

类别	Product Code	参数 Parameter
额定功率	Rated Power	60W
光源 / 数量	LED Quantity	LED / 30pcs
输入电压	Input Voltage	90-305V AC
色温	Color Temperature	3000K / 4000K / 5700K
50%光束角	50% Beam Angle	50x130°
控制方式	Control Mode	ON-OFF
使用寿命	Life	>30000H
防护等级	Protection Grade	IP 65
工作环境温度	Temperature of Working Condition	-25°C~50°C
灯具净重	Net Weight	8kg
中包规格	Package Specification	485x450x180mm
外箱规格 / 数量	Outside Box Specifications / Quantity	505x470x380mm / 2pcs

S0087 Series

专利号 Num: 201030159019.3



整体注塑二次配光反光罩，表面镀UV。
Injected reflector, UV coated.



敞开式散热片，提高散热效果。
Open-type heat sink, improve heat dissipation efficiency.



不锈钢转轴和丝印超白钢化玻璃。
Stainless steel spindle and silk-printing ultrawhite tempered glass.



可旋转固定支架带刻度显示。
Rotatable mounting bracket with dial.

适用场合

主要应用于庭院、小区、停车场等。

The Application of Occasions

Suitable places: Garden, Housing Estate road, Parking lot etc.

产品特点说明

1. 经典的工业设计造型来自于生活，美学与实用的完美结合，外观和结构专利。
2. 灯体主体部分采用高压压铸铝，表面双层静电喷塑处理，防腐蚀、抗老化，保证6年以上的使用寿命。
3. 采用进口ABS材料注塑成型反光罩，融入科学的二次配光设计技术，表面镀铬，既有效提高了光的利用率又升华了灯具整体的美观程度。
4. 采用高效率、高稳定性恒流驱动电源，保证了光源的确定工作，降低光衰，延长使用寿命。
5. 齿轮式安装支架可旋转调节灯具在垂直方向上的安装角度，刻度盘的配合使用使得安装更加的方便和准确。
6. 采用硅橡胶密封结构设计，有效保证了防护等级IP65。

Product Description

1. Classical industrial design, Perfect aesthetic and practical union, patented appearance and structure technology.
2. High pressure Aluminium die-cast housing, coated with outdoor used powder, double anti-corrosion to ensure 8 year long-life span
3. Using ABS reflector, chrome finishment.
4. High efficiency constant current driver, ensure the light source is maximum used.
5. Gear type mount bracket can adjust the installation angle on vertical direction, setting up with dial to ensure the accurate installation degree.
6. Using silicone rubber leakproof structure design to ensure the high level of IP rating (IP-65).

CE RoHS CCC E IP65

配光曲线 Light Distribution Curve

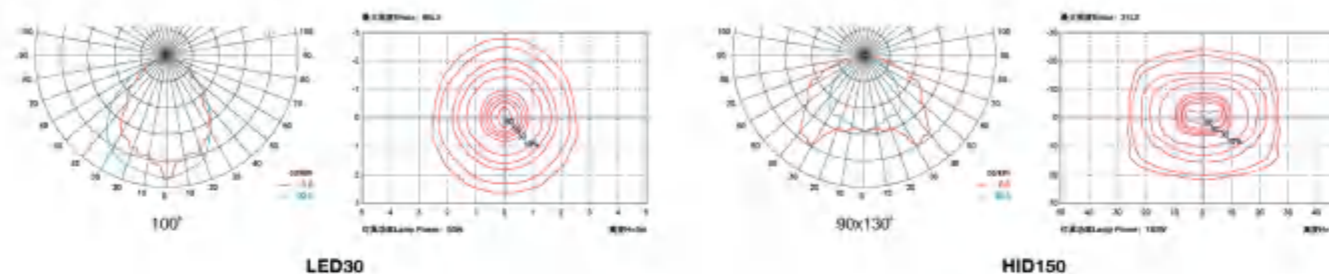

技术参数 Specification

型号 Model	LED30		HID150		输入电压 Input Voltage	LED30		HID150	
	LED30	HID150	LED30	HID150		LED30	HID150		
额定功率 Rated Power	50W	150W	光源 / 数量 Light Source / Quantity	LED / 30pcs	E40 / 1pcs	输入电压 Input Voltage	90-305V AC	AC 220V	
色温 Color Temperature	300K/400K/5700K	3000K / 4200K	50%光束角 50% Beam Angle	100°	90x130°	控制方式 Control Mode	ON-OFF		
使用寿命 Life	>30000H		防护等级 Protection Grade	IP 65		工作环境温度 Temperature of Working Condition	-25°C~50°C		
灯具净重 Net Weight	6.5kg	5kg	中包规格 Package Specification	540x310x200mm		外箱规格 / 数量 Outside Box Specification / Quantity	560x330x430mm / 2pcs		

散热模拟图 Thermal Simulation Figure

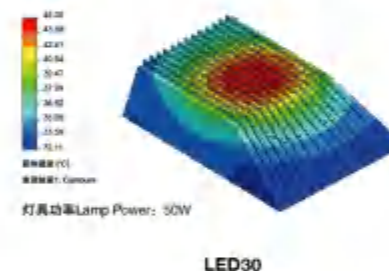

颜色选择 Color Selection

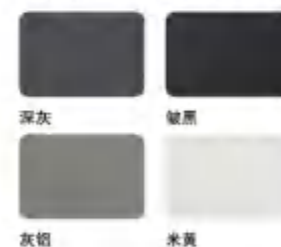

产品尺寸 Product Size

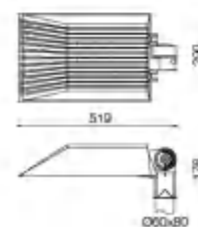

S0120MI Series

专利设计 DESIGN PATENT



专业二次道路配光。
Scientific secondary light distribution.



一体式反光罩固定板, 提高整灯美观程度。
Integrated reflector, increase the aesthetic measure.



整体压铸散热灯体。
Aluminium die-cast heat dissipation body.



封闭式光源墙体, 优质铝反光罩。
Close-type light source with high quality aluminium reflector.

适用场合

主要应用于庭院、小区、停车场等。

The Application of Occasions

Suitable places: Garden, Housing Estate road, Parking lot etc.

产品特点说明

1. 经典的工业设计造型来自于海滩贝壳, 美学与实用的完美结合, 外观和结构专利。
2. 灯体主体部分采用高压压铸铝, 表面双层静电喷塑处理, 防腐蚀性、抗老化, 保证8年以上的使用寿命。
3. 透光罩采用压制玻璃, 融入科学的二次配光设计技术和美学的设计理念, 提高了灯具整体的美观程度和使用性能。
4. 采用高效率、高稳定性恒流驱动电源, 保证了光源的稳定工作, 降低光衰, 延长使用寿命。
5. 灯体表面设计了纵向散热片有利于通风, 增加散热面积, 迅速散热, 升华了灯具的整体美观程度, 同时有利于去雨雪和灰尘, 提高了灯具的自洁能力。
6. 采用硅橡胶密封结构设计, 有效保证了防护等级IP65。
7. 安装采用高压压铸铝接套和铝合金型材配套使用, 使得安装方便牢固。

Product Description

1. Design concept from the beach shells shape, Perfect aesthetic and practical union, patented appearance and structure technology.
2. High pressure Aluminium die-cast housing, coated with outdoor used powder, double anti-corrosion to ensure 8 year long-life span.
3. Pressing glass diffuser, effectively improve the transmission rate of light.
4. High efficiency constant current driver, ensure the light source is maximum used.
5. Axial heat sink design on light body surface, increase the efficiency of heat-dissipation.
6. Using silicone rubber leakproof structure design to ensure the high level of IP rating (IP-65).
7. Connected by high pressure aluminium die-cast joint and aluminium alloy tube, simple installation.



配光曲线 Light Distribution Curve

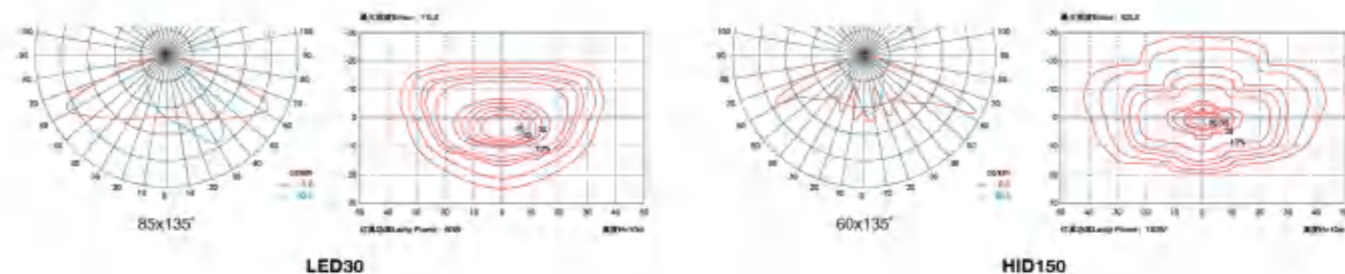

技术参数 Specification

参数	LED30		HID150		参数	LED30		HID150	
	LED30	HID150	LED30	HID150		LED30	HID150		
额定功率 Rated Power	60W	150W	光源 / 数量 Light Source / Quantity	LED / 30pcs	E40 / 1pcs	输入电压 Input Voltage	90-305V AC	AC 220V	
色温 Color Temperature	3000K/4000K/5700K	3000K / 4200K	50%光束角 50% Beam Angle	85x135°	60x135°	控制方式 Control Mode	ON-OFF		
使用寿命 Life	>30000H		防护等级 Protection Grade	IP 65		工作环境温度 Temperature of Working Condition	-25°C~50°C		
灯具净重 Net Weight	9kg	7.8kg	中包规格 Package Specification			外箱规格 / 数量 Outside Box Specifications / Quantity	445x445x885mm / 1pcs		

散热模拟图 Thermal Simulation Figure

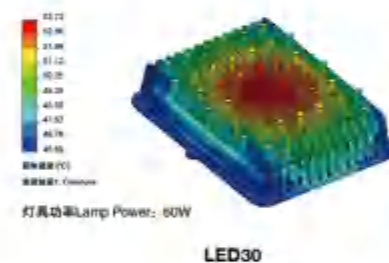

颜色选择 Color Selection

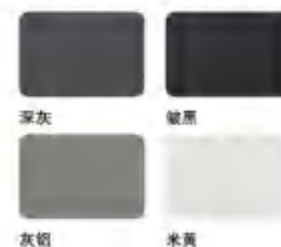

产品尺寸 Product Size

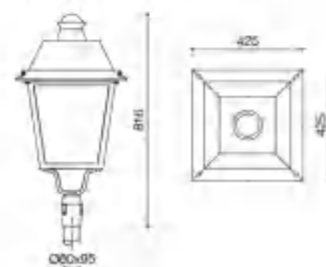

S0120 Series

专利设计 DESIGN PATENT



专业二次道路配光。
Scientific secondary light distribution.



一体式反光罩固定板, 提高整灯美观程度。
Integrated reflector, increase the aesthetic measure.



整体压铸散热灯体。
Aluminium die-cast heat dissipation body.



封闭式光源墙体, 优质铝反光罩。
Close-type light source with high quality aluminium reflector.

适用场合

主要应用于庭院、小区、停车场等。

The Application of Occasions

Suitable places: Garden, Housing Estate road, Parking lot etc.

产品特点说明

1. 经典的工业设计造型来自于海滩贝壳, 美学与实用的完美结合, 外观和结构专利。
2. 灯体主体部分采用高压压铸铝, 表面双层静电喷塑处理, 防腐性、抗老化, 保证8年以上的使用寿命。
3. 透光罩采用压制玻璃, 融入科学的二次配光设计技术和美学的设计理念, 提高了灯具整体的美观程度和使用性能。
4. 采用高效率、高稳定性恒流驱动电源, 保证了光源的稳定工作, 降低光衰, 延长使用寿命。
5. 灯体表面设计了纵向散热片有利于通风, 增加散热面积, 迅速散热, 升华了灯具的整体美观程度, 同时有利于去雨雪和灰尘, 提高了灯具的自洁能力。
6. 采用硅橡胶密封结构设计, 有效保证了防护等级IP65。
7. 安装采用高压压铸铝接套和铝合金型材管配套使用, 使得安装方便牢固。

Product Description

1. Design concept from the beach shells shape, Perfect aesthetic and practical union, patented appearance and structure technology.
2. High pressure Aluminium die-cast housing, coated with outdoor used powder, double anti-corrosion to ensure 8 year long-life span.
3. Pressing glass diffuser, effectively improve the transmission rate of light.
4. High efficiency constant current driver, ensure the light source is maximum used.
5. Axial heat sink design on light body surface, increase the efficiency of heat-dissipation.
6. Using silicone rubber leakproof structure design to ensure the high level of IP rating (IP-65).
7. Connected by high pressure aluminium die-cast joint and aluminium alloy tube, simple installation.



配光曲线 Light Distribution Curve

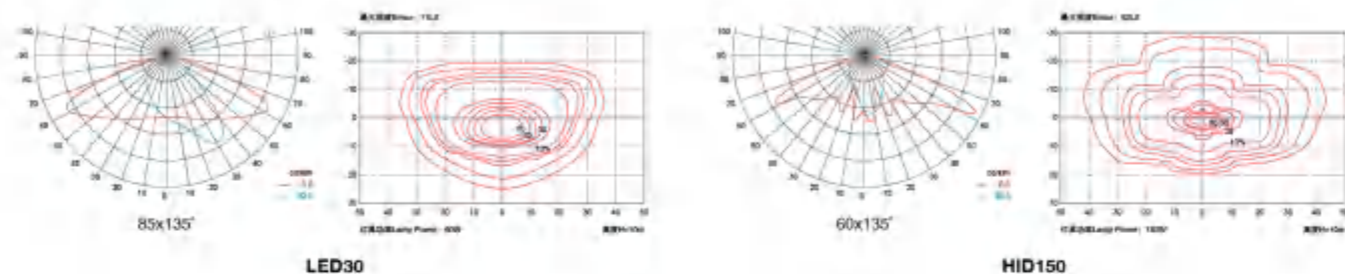

技术参数 Specification

参数	LED30	HID150	参数	LED30	HID150	参数	LED30	HID150
额定功率 Rated Power	60W	150W	光源 / 数量 Light Source / Quantity	LED / 30pcs	E40 / 1pcs	输入电压 Input Voltage	90-305V AC	AC 220V
色温 Color Temperature	3000K/4000K/5700K	3000K / 4200K	50%光束角 50% Beam Angle	85x135°	60x135°	控制方式 Control Mode	ON-OFF	
使用寿命 Life	>30000H		防护等级 Protection Grade	IP 65		工作环境温度 Temperature of Working Condition	-25°C~50°C	
灯具净重 Net Weight	5.7kg	4.8kg	中包规格 Package Specification			外箱规格 / 数量 Outside Box Specification / Quantity	440x440x410mm / 1pcs	

散热模拟图 Thermal Simulation Figure

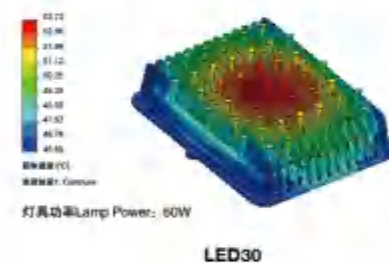

颜色选择 Color Selection

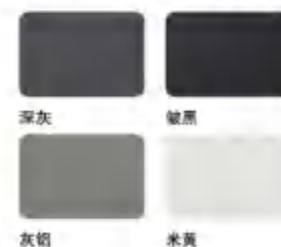

产品尺寸 Product Size

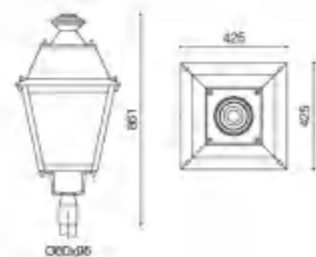

S0095B Series

专利设计 DESIGN PATENT



专业二次道路配光。
Scientific secondary light distribution.



封闭式光源箱体，优质铝反光罩。
Close-type light source with high quality aluminium reflector.



钢丝绳拉锁，提升安全性能。
Wierope lock, increase the safety of fitting.



灯盖按钮式开合，便于安装维护。
Button design, convenient for installation and maintenance.

适用场合

主要应用于城镇主干路、快速路、省道、国道等。

The Application of Occasions

Suitable places: City main street, Highway, National highway and provincial highway, etc.

产品特点说明

1. 经典的工业设计造型，美学与实用的完美结合。
2. 灯体主体部分采用高压压铸铝，表面双层静电喷塑处理，防腐蚀、抗老化，保证8年以上的使用寿命。
3. 二次光学透镜配光，满足庭院和道路照明的需求。
4. 透光罩采用超白钢化玻璃，提高整灯光效。
5. 采用硅橡胶密封结构设计，有效保证了防护等级IP65。
6. 多种安装方式，满足不同效果和场合的使用。
7. 按钮式开盖和安全防拉绳，维修简便。

Product Description

1. Classical industrial design, perfect aesthetic and practical union.
2. High pressure aluminium die-cast body, coated with outdoor used powder, double anti-corrosion to ensure 8 years long-life span.
3. Scientific optical lens design to satisfies the illumination requests of yard and road.
4. Ultrawhite tempered glass diffuser, improve the luminous efficiency.
5. Using silicone rubber leakproof structure design to ensure the high level of IP rating(IP:65).
6. Multiple installations to satisfy the uses of different effects and places.
7. Button design and safety rope is convenient for repair.

CE RoHS CCC IP65

配光曲线 Light Distribution Curve

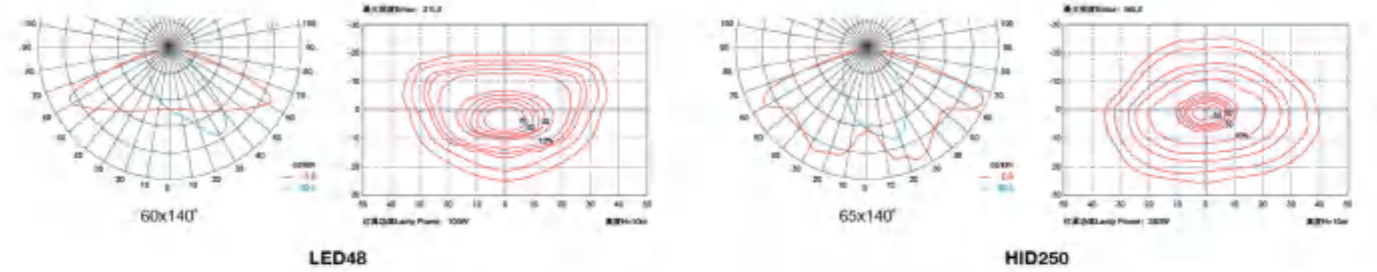

技术参数 Specification

参数 Parameter	型号 Model		型号 Model		参数 Parameter	型号 Model	
	LED48	HID250	LED48	HID250		LED48	HID250
额定功率 Rated Power	100W	250W	光源 / 数量 Light Source / Quantity	LED / 24pcs	E40 / 1pcs	输入电压 Input Voltage	90-305V AC AC 220V
色温 Color Temperature	3000K/4000K/5700K	3000K / 4200K	50%光束角 50% Beam Angle	60x140°	65x140°	控制方式 Control Mode	ON-OFF
使用寿命 Life	>30000H		防护等级 Protection Grade	IP 65		工作环境温度 Temperature of Working Condition	-25°C~50°C
灯具净重 Net Weight	14.1kg	12.1kg	中包规格 Package Specification			外箱规格 / 数量 Outside Box Specifications / Quantity	570x570x870mm / 1pcs

散热模拟图 Thermal Simulation Figure

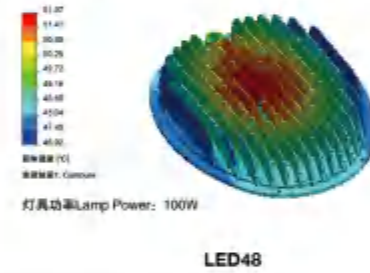

颜色选择 Color Selection

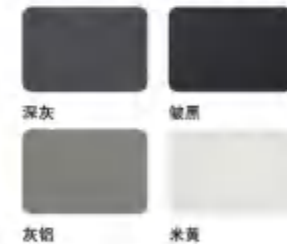

产品尺寸 Product Size



S0122

专利设计 DESIGN PATENT



扩散PC罩, 出光均匀。
Diffusion PC cover, out of uniform.



卡扣式拆卸结构设计。
The structure design of snap fastener.



整体压铸支臂。
Integral die casting arm.



压铸灯杆链接套。
Die casting lamp link set.

适用场合

主要应用于庭院、小区、停车场等。

The Application of Occasions

Suitable places: Garden, Housing Estate road, Parking lot etc.

产品特点说明

1. 经典的工业设计造型来自于海滩贝壳, 美学与实用的完美结合, 外观和结构专利。
2. 灯体主体部分采用高压压铸铝, 表面双层静电喷塑处理, 防腐蚀、抗老化, 保证8年以上的使用寿命。
3. 透光罩采用扩散PC罩, 出光柔和及均匀。
4. 采用高效率、高稳定性恒流驱动电源, 保证了光源的稳定工作, 降低光衰, 延长使用寿命。
5. 灯体表面设计了纵向散热片有利于通风, 增加散热面积, 迅速散热, 升华了灯具的整体美观程度, 同时有利于去雨雪和灰尘, 提高了灯具的自洁能力。
6. 采用硅橡胶密封结构设计, 有效保证了防护等级IP65。
7. 安装采用高压压铸铝接套和铝合金型材管配套使用, 使得安装方便牢固。

Product Description

1. Design concept from the beach shells shape, Perfect aesthetic and practical union, patented appearance and structure technology.
2. High pressure Aluminium die-cast housing, coated with outdoor used powder, double anti-corrosion to ensure 8 year long-life span.
3. The transparent cover adopts the diffused PC cover, the light is soft and uniform.
4. High efficiency constant current driver, ensure the light source is maximum used.
5. Axial heat sink design on light body surface, increase the efficiency of heat-dissipation.
6. Using silicone rubber leakproof structure design to ensure the high level of IP rating (IP:65).
7. Connected by high pressure aluminium die-cast joint and aluminium alloy tube, simple installation.



配光曲线 Light Distribution Curve

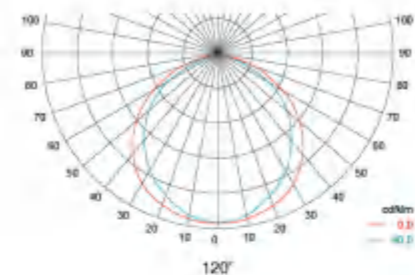

等照度图 Illumination Map

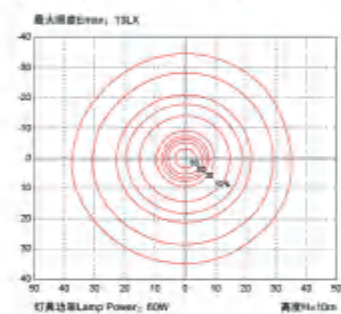

颜色选择 Color Selection

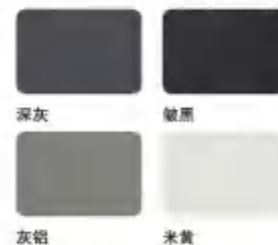

产品尺寸 Product Size

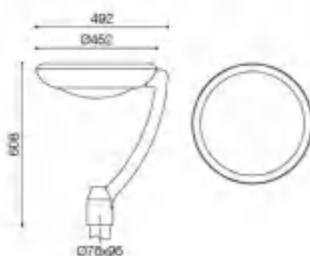

技术参数 Specification

类别	Product Code	参数 Parameter
额定功率	Rated Power	60W
光源 / 数量	LED Quantity	LED / 96pcs
输入电压	Input Voltage	90-305V AC
色温	Color Temperature	3000K / 4000K / 5700K
50%光束角	50% Beam Angle	120°
控制方式	Control Mode	ON-OFF
使用寿命	Life	>30000H
防护等级	Protection Grade	IP 65
工作环境温度	Temperature of Working Condition	-25°C~50°C
灯具净重	Net Weight	7.2kg
中包规格	Package Specification	---
外箱规格 / 数量	Outside Box Specifications / Quantity	480x440x640mm / 1pcs

S0123

专利设计 DESIGN PATENT



扩散PC罩，出光均匀。
Diffusion PC cover, out of uniform.



卡扣式拆卸结构设计。
The structure design of snap fastener.



整体压铸支臂。
Integral die casting arm.



压铸灯杆链接套。
Die casting lamp link set.

适用场合

主要应用于庭院、小区、停车场等。

The Application of Occasions

Suitable places: Garden, Housing Estate road, Parking lot etc.

产品特点说明

1. 经典的工业设计造型来自于海滩贝壳，美学与实用的完美结合，外观和结构专利。
2. 灯体主体部分采用高压压铸铝，表面双层静电喷塑处理，防腐性、抗老化，保证8年以上的使用寿命。
3. 透光罩采用扩散PC罩，出光柔和及均匀。
4. 采用高效率、高稳定性恒流驱动电源，保证了光源的稳定工作，降低光衰，延长使用寿命。
5. 灯体表面设计了纵向散热片有利于通风。增加散热面积，迅速散热，升华了灯具的整体美观程度，同时有利于去雨雪和灰尘，提高了灯具的自洁能力。
6. 采用硅橡胶密封结构设计，有效保证了防护等级IP65。
7. 安装采用高压压铸铝接套和铝合金型材管配套使用，使得安装方便牢固。

Product Description

1. Design concept from the beach shells shape, Perfect aesthetic and practical union, patented appearance and structure technology.
2. High pressure Aluminium die-cast housing, coated with outdoor used powder, double anti-corrosion to ensure 8 year long-life span.
3. The transparent cover adopts the diffused PC cover, the light is soft and uniform.
4. High efficiency constant current driver, ensure the light source is maximum used.
5. Axial heat sink design on light body surface, increase the efficiency of heat-dissipation.
6. Using silicone rubber leakproof structure design to ensure the high level of IP rating (IP:65).
7. Connected by high pressure aluminium die-cast joint and aluminium alloy tube, simple installation.



配光曲线 Light Distribution Curve

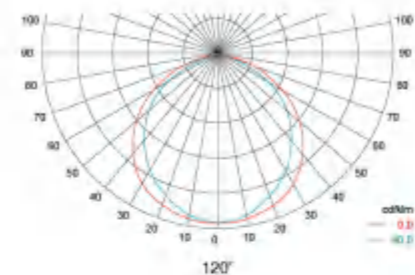

等照度图 Illumination Map

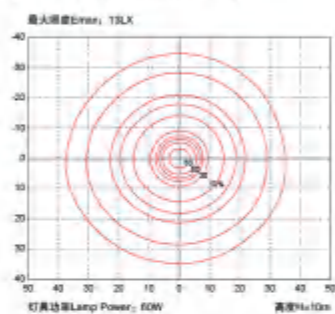

颜色选择 Color Selection

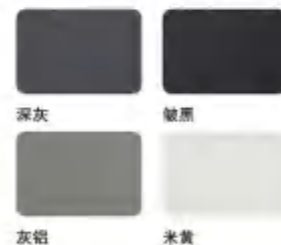

产品尺寸 Product Size

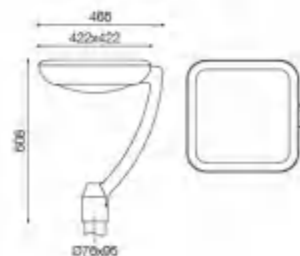

技术参数 Specification

类别	Product Code	参数 Parameter
额定功率	Rated Power	60W
光源 / 数量	LED Quantity	LED / 96pcs
输入电压	Input Voltage	90-305V AC
色温	Color Temperature	3000K / 4000K / 5700K
50%光束角	50% Beam Angle	120°
控制方式	Control Mode	ON-OFF
使用寿命	Life	>30000H
防护等级	Protection Grade	IP 65
工作环境温度	Temperature of Working Condition	-25°C~50°C
灯具净重	Net Weight	7kg
中包规格	Package Specification	---
外箱规格 / 数量	Outside Box Specifications / Quantity	470x470x640mm / 1pcs

S0036

专利号 Num: 201230154181.5
201220269416.X



适用场合

主要应用于庭院、小区、停车场等。

The Application of Occasions

Suitable places: Garden, Housing Estate road, Parking lot etc.

产品特点说明

1. 独特的外观设计来自于大自然的葵花，与小区、园林绿化环境融为一体。太阳能板安装与灯体上面和叶片上面，增强太阳光的吸收率，同时使得产品更接近大自然外观和结构专利。
2. 灯体主体部分采用高压压铸铝和不锈钢材质，表面双层静电喷漆处理，防腐蚀、抗老化，保证8年以上的使用寿命。
3. 透光罩采用进口PC材料，更有效的提高了光的透射率。
4. 配光采用LED一次封装，提高光的利用率。
5. 采用高效率、高稳定性恒流驱动电源，保证了光源的稳定工作，降低光衰，延长使用寿命。
6. 灯头周边类似花瓣的设计，有效的增加散热面积，迅速散热，升华了灯具的整体美观程度。

Product Description

1. Sunflower design, use solar power, energy-saving and environmental protection.
2. Aluminium die-cast body, coated with outdoor used powder, double anti-static surfaces to ensure 8 year long-life span.
3. Imported PC diffuser, effectively improve the transmission rate of light.
4. Patented encapsulation technology, improve the utilization rate of the light.
5. High efficiency constant current driver, ensure the light source is maximum used.
6. Petaline design, Guarantee the heat-dissipation area and aesthetic measure of the lamps.

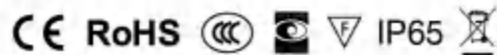

整体压铸仿真头部。
Aluminium die-cast sunflower head design.

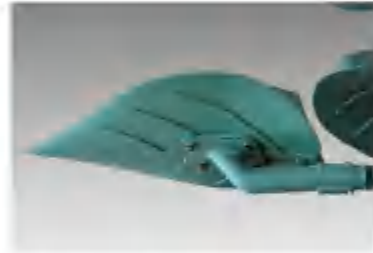

整体压铸仿真叶片。
Aluminium die-cast emulational leaf design.



不锈钢压铸可旋转安装支架。
Rotatable stainless steel mounting bracket.

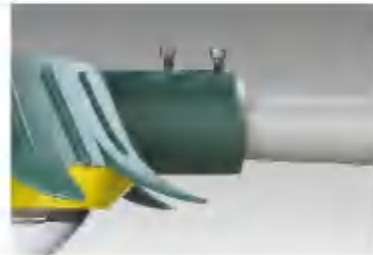

Ø60mm管连接，配套安全螺栓。
Ø60mm pole-connector with safety bolts.

配光曲线 Light Distribution Curve

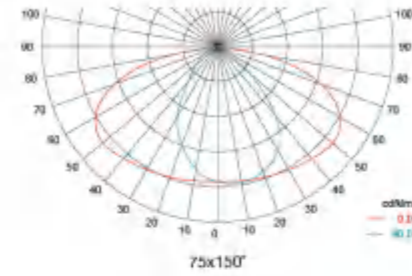

等照度图 Illumination Map

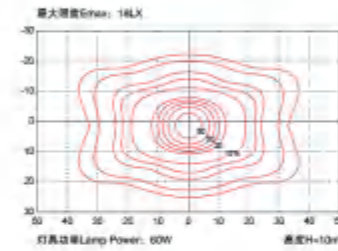

散热模拟图 Thermal Simulation Figure

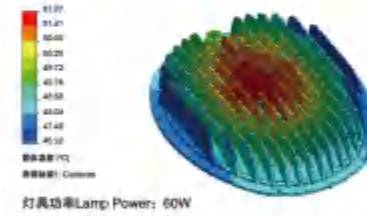

颜色选择 Color Selection

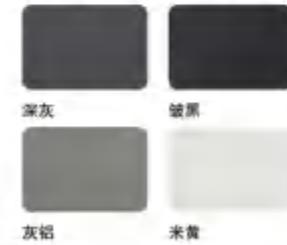

产品尺寸 Product Size

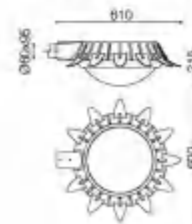

技术参数 Specification

类别	Product Code	参数 Parameter
额定功率	Rated Power	60W
光源 / 数量	LED Quantity	LED / 24pcs
输入电压	Input Voltage	90-305V AC
色温	Color Temperature	3000K / 4000K / 5700K
50%光束角	50% Beam Angle	75x150°
控制方式	Control Mode	ON-OFF
使用寿命	Life	>30000H
防护等级	Protection Grade	IP 65
工作环境温度	Temperature of Working Condition	-25°C~50°C
灯具净重	Net Weight	10kg
中包规格	Package Specification	---
外箱规格 / 数量	Outside Box Specifications / Quantity	620x620x250mm / 1pcs

S0065-LED48

专利号 Num: 201320457480.5
201320453066.7

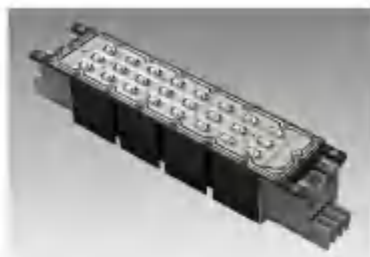

模块化和专业二次道路配光。
Modular and scientific optical lens design.



模块插拔式安装及更换。
Modular type installation and replacement.



独立的电源腔体和优质硅胶密封。
Independent power supply housing with high quality silicone rubber sealing.



电器腔锁扣式开合。
Buckle design for electric part housing.

适用场合

主要应用于主干道、城镇道路、快速路、省道、国道等。

The Application of Occasions

Suitable places: City main street, Highway, National highway and provincial highway.

产品特点说明

1. 极简的工业设计造型，美学与实用的完美结合，外观和结构专利。
2. 灯体主体部分采用高压压铸铝，表面双层静电喷塑处理，防腐性、抗老化，保证8年以上的使用寿命。
3. 直接光学透镜二次配光，无玻璃，大大提升整灯光效。
4. 独立的电源腔体并采用高效率、高稳定性恒流驱动电源，保证了光源的稳定工作，降低光衰，延长使用寿命。
5. 模块式独立散热，表面横向、纵向、垂直三向通风，加快散热。
6. 采用硅胶橡胶密封结构设计，有效保证了防护等级IP65。
7. 模块插拔式安装及拆卸维护，无需工具，使得装配和维护更为简便。

Product Description

1. Simple industrial design, perfect aesthetic and practical union, patented appearance and structure technology.
2. High pressure aluminium die-cast body, coated with outdoor used powder, double anti-corrosion to ensure 8 years long-life span.
3. Scientific optical lens design, without glass, greatly improve the luminous efficiency.
4. Independent power supply recessed design, using high efficiency and stability constant current driver to extend working life.
5. Modules design independent speed up heat dissipation.
6. Using silicone rubber leakproof structure design to ensure the high level of IP rating(IP:65).
7. Easy installation and maintenance with modules design.

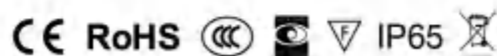

配光曲线 Light Distribution Curve

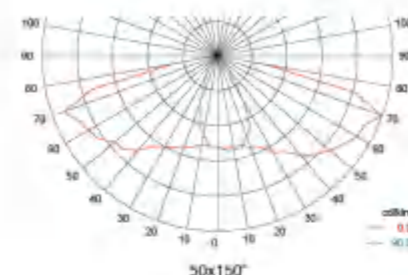

等照度图 Illumination Map

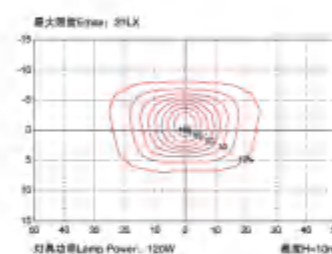

散热模拟图 Thermal Simulation Figure

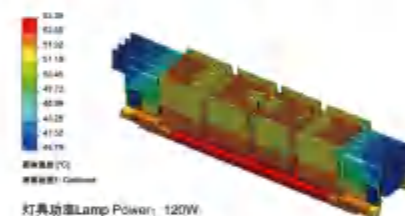

产品尺寸 Product Size

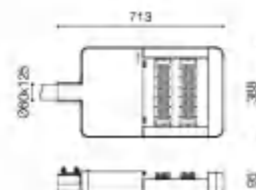

道路模拟 Simulation For Lighting on Road

类别	Performance	参数 Parameter	
额定功率	Rated Power	100W	120W
道路宽度(W)	Road Width	15 m	15 m
安装高度(1)	Installation Height	10 m	10 m
灯杆间距(L)	Lamp Pole Distance	30 m	30 m
突出(2)	Protruding Length	1 m	1 m
吊杆角度(3)	Hanging Pole Angle	15°	15°
维护系数	Maintenance Factor	0.8	0.8
平均照度	Average Illuminance	28 lx	31 lx
最大照度	Max illuminance	37 lx	42 lx
最小照度	Min illuminance	17 lx	19 lx
照度总均匀度	Uniformity of Illuminance	0.602	0.602
平均亮度	Average Luminance	2.2 cd/m ²	2.51 cd/m ²
总均匀度	Overall Uniformity	0.51 Uo	0.51 Uo
纵向均匀度	Longitudinal Uniformity	0.61 UL	0.61 UL
阈值增量	Threshold Increment	12% TI	12% TI
环境比	Surround Ratio	0.59 SR	0.59 SR



颜色选择 Color Selection

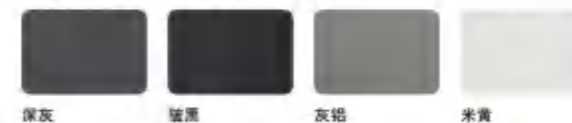

技术参数 Specification

类别	Product Code	参数 Parameter	
额定功率	Rated Power	100W	120W
输入电压	Input Voltage	90-305V AC	
频率范围	Frequency	50 / 60Hz	
功率因数	Power Factor	> 0.95	
光源 / 数量	LED Quantity	LED / 48pcs	
灯珠品牌	Brand	CREE	
色温	Color Temperature	3000K / 4000K / 5700K	
显色指数	Ra	≥70	
初始光通量	Initial Luminous Flux	10000 lm	11400 lm
整灯光效	Luminous Efficacy	100 lm/w	95 lm/w
电源品牌	Power Supply Brand	明伟 / 飞利浦 / 英飞特	
工作环境温度	Temperature of Working Condition	-25°C-50°C	
使用寿命	Life	>30000H	
防护等级	Protection Grade	IP 65	
灯具净重	Net Weight	12kg	
外箱规格	Outside Box Specifications	730x410x130mm / 1pcs	

S0065-LED72

专利号 Num: 201320457480.5
201320453066.7

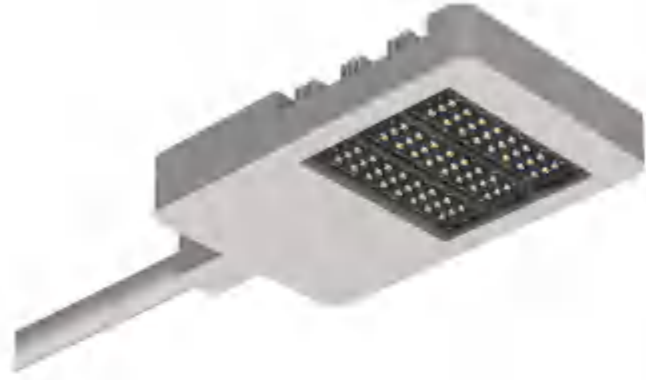

模块化和专业二次道路配光。
Modular and scientific optical lens design.



模块插拔式安装及更换。
Modular type installation and replacement.

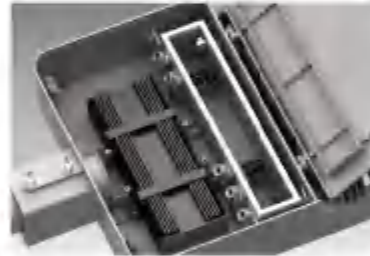

独立的电源腔体和优质硅胶密封。
Independent power supply housing with high quality silicone rubber sealing.



电器腔锁扣式开合。
Buckle design for electric part housing.

适用场合

主要应用于主干道、城镇道路、快速路、省道、国道等。

The Application of Occasions

Suitable places: City main street, Highway, National highway and provincial highway.

产品特点说明

1. 极简的工业设计造型，美学与实用的完美结合，外观和结构专利。
2. 灯体主体部分采用高压压铸铝，表面双层静电喷塑处理，防腐性、抗老化，保证8年以上的使用寿命。
3. 直接光学透镜二次配光，无玻璃，大大提升整灯光效。
4. 独立的电源腔体并采用高效率、高稳定性恒流驱动电源，保证了光源的稳定工作，降低光衰，延长使用寿命。
5. 模块式独立散热，表面横向、纵向、垂直三向通风，加快散热。
6. 采用硅胶橡胶密封结构设计，有效保证了防护等级IP65。
7. 模块插拔式安装及拆卸维护，无需工具，使得装配和维护更为简便。

Product Description

1. Simple industrial design, perfect aesthetic and practical union, patented appearance and structure technology.
2. High pressure aluminium die-cast body, coated with outdoor used powder, double anti-corrosion to ensure 8 years long-life span.
3. Scientific optical lens design, without glass, greatly improve the luminous efficiency.
4. Independent power supply recessed design, using high efficiency and stability constant current driver to extend working life.
5. Modules design independent speed up heat dissipation.
6. Using silicone rubber leakproof structure design to ensure the high level of IP rating(IP:65).
7. Easy installation and maintenance with modules design.



配光曲线 Light Distribution Curve

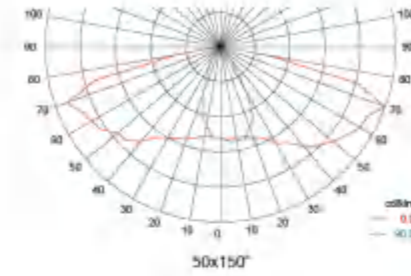

等照度图 Illumination Map

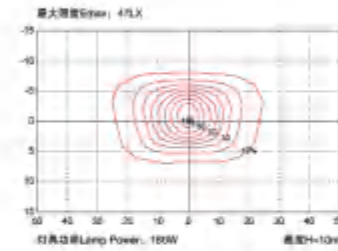

散热模拟图 Thermal Simulation Figure

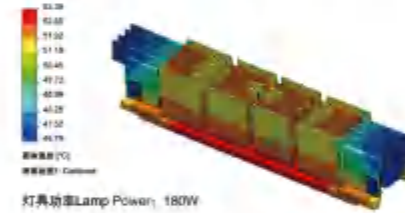

产品尺寸 Product Size

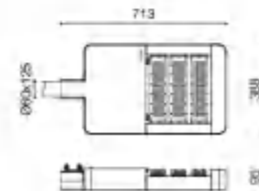

道路模拟 Simulation For Lighting on Road

类别	Performance	参数 Parameter	
额定功率	Rated Power	150W	180W
道路宽度(W)	Road Width	15 m	15 m
安装高度(1)	Installation Height	12 m	12 m
灯杆间距(L)	Lamp Pole Distance	40 m	40 m
突出(2)	Protruding Length	1 m	1 m
吊杆角度(3)	Hanging Pole Angle	15°	15°
维护系数	Maintenance Factor	0.8	0.8
平均照度	Average Illuminance	30 lx	34 lx
最大照度	Max illuminance	46 lx	52 lx
最小照度	Min illuminance	17 lx	19 lx
照度总均匀度	Uniformity of Illuminance	0.548	0.548
平均亮度	Average Luminance	2.39 cd/m ²	2.72 cd/m ²
总均匀度	Overall Uniformity	0.45 U _o	0.45 U _o
纵向均匀度	Longitudinal Uniformity	0.62 U _L	0.62 U _L
阈值增量	Threshold Increment	13% TI	13% TI
环境比	Surround Ratio	0.63 SR	0.63 SR



颜色选择 Color Selection



技术参数 Specification

类别	Product Code	参数 Parameter	
额定功率	Rated Power	150W	180W
输入电压	Input Voltage	90-305V AC	
频率范围	Frequency	50 / 60Hz	
功率因数	Power Factor	> 0.95	
光源 / 数量	LED Quantity	LED / 72pcs	
灯珠品牌	Brand	CREE	
色温	Color Temperature	3000K / 4000K / 5700K	
显色指数	Ra	≥ 70	
初始光通量	Initial Luminous Flux	15000 lm	17100 lm
整灯光效	Luminous Efficacy	100 lm/w	95 lm/w
电源品牌	Power Supply Brand	明伟 / 飞利浦 / 英飞特	
工作环境温度	Temperature of Working Condition	-25°C-50°C	
使用寿命	Life	>30000H	
防护等级	Protection Grade	IP 65	
灯具净重	Net Weight	14kg	
外箱规格	Outside Box Specifications	730x410x130mm / 1pcs	

S0065-LED96

专利号 Num: 201320457480.5
201320453066.7

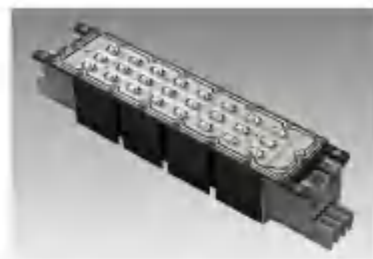
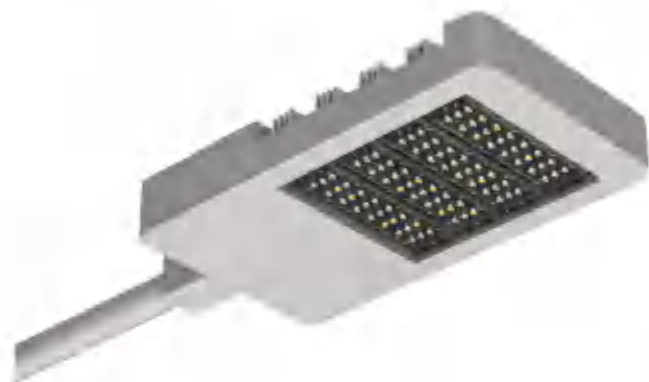

模块化和专业二次道路配光。
Modular and scientific optical lens design.



模块插拔式安装及更换。
Modular type installation and replacement.



独立的电源腔体和优质硅胶密封。
Independent power supply housing with high quality silicone rubber sealing.



电器腔锁扣式开合。
Buckle design for electric part housing.

适用场合

主要应用于主干道、城镇道路、快速路、省道、国道等。

The Application of Occasions

Suitable places: City main street, Highway, National highway and provincial highway.

产品特点说明

1. 极简的工业设计造型，美学与实用的完美结合，外观和结构专利。
2. 灯体主体部分采用高压压铸铝，表面双层静电喷塑处理，防腐性、抗老化，保证8年以上的使用寿命。
3. 直接光学透镜二次配光，无玻璃，大大提升整灯光效。
4. 独立的电源腔体并采用高效率、高稳定性恒流驱动电源，保证了光源的稳定工作，降低光衰，延长使用寿命。
5. 模块式独立散热，表面横向、纵向、垂直三向通风，加快散热。
6. 采用硅胶橡胶密封结构设计，有效保证了防护等级IP65。
7. 模块插拔式安装及拆卸维护，无需工具，使得装配和维护更为简便。

Product Description

1. Simple industrial design, perfect aesthetic and practical union, patented appearance and structure technology.
2. High pressure aluminium die-cast body, coated with outdoor used powder, double anti-corrosion to ensure 8 years long-life span.
3. Scientific optical lens design, without glass, greatly improve the luminous efficiency.
4. Independent power supply recessed design, using high efficiency and stability constant current driver to extend working life.
5. Modules design independent speed up heat dissipation.
6. Using silicone rubber leakproof structure design to ensure the high level of IP rating(IP:65).
7. Easy installation and maintenance with modules design.

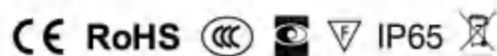

配光曲线 Light Distribution Curve

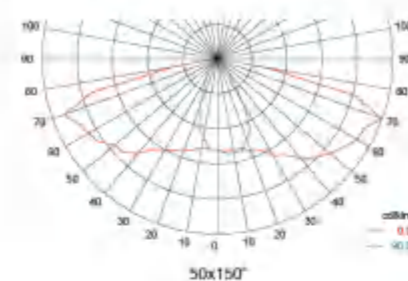

等照度图 Illumination Map

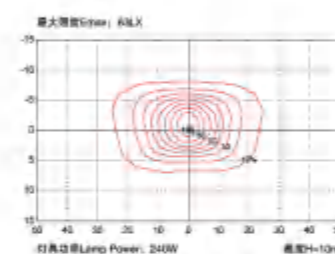

散热模拟图 Thermal Simulation Figure

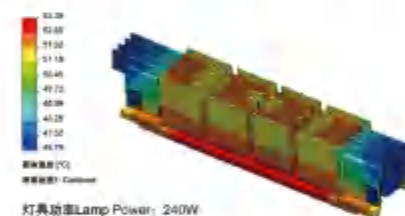

产品尺寸 Product Size

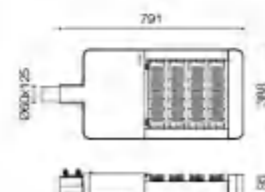

道路模拟 Simulation For Lighting on Road

类别	Performance	参数 Parameter	
额定功率	Rated Power	200W	240W
道路宽度(W)	Road Width	22.5 m	22.5 m
安装高度(1)	Installation Height	12 m	12 m
灯杆间距(L)	Lamp Pole Distance	40 m	40 m
突出(2)	Protruding Length	1.5 m	1.5 m
吊杆角度(3)	Hanging Pole Angle	15°	15°
维护系数	Maintenance Factor	0.8	0.8
平均照度	Average Illuminance	28 lx	32 lx
最大照度	Max illuminance	42 lx	48 lx
最小照度	Min illuminance	16 lx	18 lx
照度总均匀度	Uniformity of Illuminance	0.580	0.580
平均亮度	Average Luminance	2.22 cd/m ²	2.53 cd/m ²
总均匀度	Overall Uniformity	0.43 U _o	0.43 U _o
纵向均匀度	Longitudinal Uniformity	0.61 U _L	0.61 U _L
阈值增量	Threshold Increment	13% TI	13% TI
环境比	Surround Ratio	0.63 SR	0.63 SR

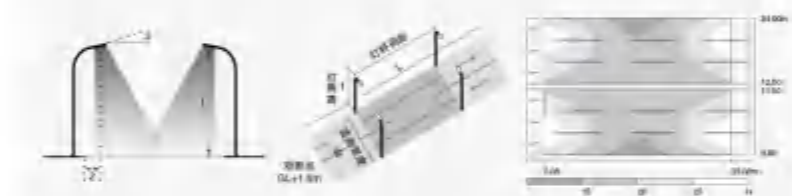

颜色选择 Color Selection

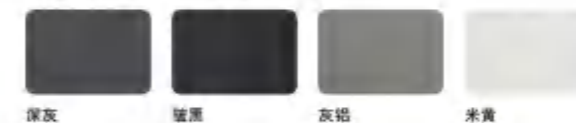

技术参数 Specification

类别	Product Code	参数 Parameter	
额定功率	Rated Power	200W	240W
输入电压	Input Voltage	90-305V AC	
频率范围	Frequency	50 / 60Hz	
功率因数	Power Factor	> 0.95	
光源 / 数量	LED Quantity	LED / 96pcs	
灯珠品牌	Brand	CREE	
色温	Color Temperature	3000K / 4000K / 5700K	
显色指数	Ra	≥ 70	
初始光通量	Initial Luminous Flux	20000 lm	22800 lm
整灯光效	Luminous Efficacy	100 lm/w	95 lm/w
电源品牌	Power Supply Brand	明伟 / 飞利浦 / 英飞特	
工作环境温度	Temperature of Working Condition	-25°C-50°C	
使用寿命	Life	>30000H	
防护等级	Protection Grade	IP 65	
灯具净重	Net Weight	15kg	
外箱规格	Outside Box Specifications	810x410x130mm / 1pcs	

S0065-LED120

专利号 Num: 201320457480.5
201320453066.7

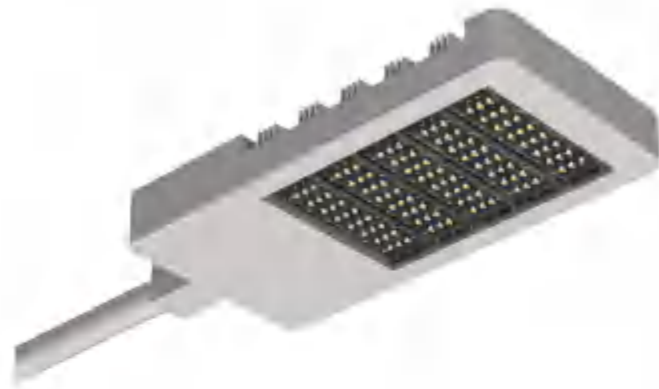

适用场合

主要应用于主干道、城镇道路、快速路、省道、国道等。

The Application of Occasions

Suitable places: City main street, Highway, National highway and provincial highway.

产品特点说明

1. 极简的工业设计造型，美学与实用的完美结合，外观和结构专利。
2. 灯体主体部分采用高压压铸铝，表面双层静电喷塑处理，防腐性、抗老化，保证8年以上的使用寿命。
3. 直接光学透镜二次配光，无玻璃，大大提升整灯光效。
4. 独立的电源腔体并采用高效率、高稳定性恒流驱动电源，保证了光源的稳定工作，降低光衰，延长使用寿命。
5. 模块式独立散热，表面横向、纵向、垂直三向通风，加快散热。
6. 采用硅橡胶密封结构设计，有效保证了防护等级IP65。
7. 模块插拔式安装及拆卸维护，无需工具，使得装配和维护更为简便。

Product Description

1. Simple industrial design, perfect aesthetic and practical union, patented appearance and structure technology.
2. High pressure aluminium die-cast body, coated with outdoor used powder, double anti-corrosion to ensure 8 years long-life span.
3. Scientific optical lens design, without glass, greatly improve the luminous efficiency.
4. Independent power supply recessed design, using high efficiency and stability constant current driver to extend working life.
5. Modules design independent speed up heat dissipation.
6. Using silicone rubber leakproof structure design to ensure the high level of IP rating(IP:65).
7. Easy installation and maintenance with modules design.

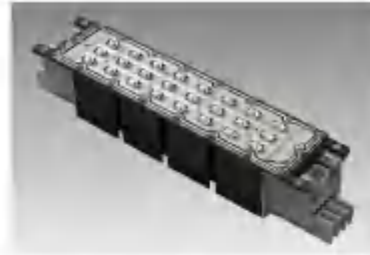

模块式和专业二次道路配光。
Modular and scientific optical lens design.



模块插拔式安装及更换。
Modular type installation and replacement.

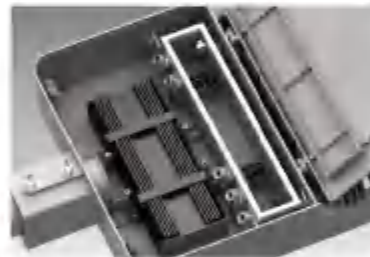

独立的电源腔体和优质硅胶密封。
Independent power supply housing with high quality silicone rubber sealing.



电器腔锁扣式开合。
Buckle design for electric part housing.

配光曲线 Light Distribution Curve

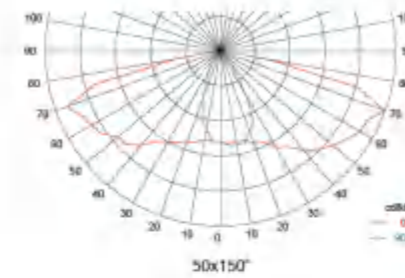

等照度图 Illumination Map

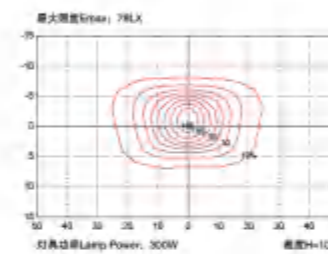

散热模拟图 Thermal Simulation Figure

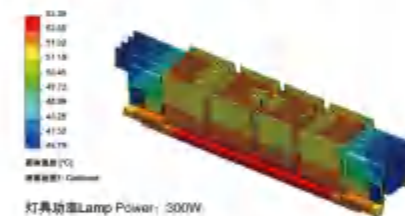

产品尺寸 Product Size

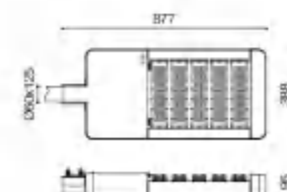

道路模拟 Simulation For Lighting on Road

类别	Performance	参数 Parameter	
额定功率	Rated Power	240W	300W
道路宽度(W)	Road Width	22.5 m	22.5 m
安装高度(1)	Installation Height	12 m	12 m
灯杆间距(L)	Lamp Pole Distance	40 m	40 m
突出(2)	Protruding Length	1.5 m	1.5 m
吊杆角度(3)	Hanging Pole Angle	15°	15°
维护系数	Maintenance Factor	0.8	0.8
平均照度	Average Illuminance	34 lx	40 lx
最大照度	Max illuminance	50 lx	60 lx
最小照度	Min illuminance	19 lx	23 lx
照度总均匀度	Uniformity of Illuminance	0.580	0.580
平均亮度	Average Luminance	2.67 cd/m ²	3.17 cd/m ²
总均匀度	Overall Uniformity	0.43 Uo	0.43 Uo
纵向均匀度	Longitudinal Uniformity	0.63 UL	0.63 UL
阈值增量	Threshold Increment	13% TI	13% TI
环境比	Surround Ratio	0.61 SR	0.61 SR



颜色选择 Color Selection

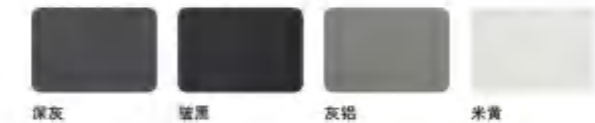

技术参数 Specification

类别	Product Code	参数 Parameter	
额定功率	Rated Power	240W	300W
输入电压	Input Voltage	90-305V AC	
频率范围	Frequency	50 / 60Hz	
功率因数	Power Factor	> 0.95	
光源 / 数量	LED Quantity	LED / 120pcs	
灯珠品牌	Brand	CREE	
色温	Color Temperature	3000K / 4000K / 5700K	
显色指数	Ra	≥70	
初始光通量	Initial Luminous Flux	24000 lm	28500 lm
整灯光效	Luminous Efficacy	100 lm/w	95 lm/w
电源品牌	Power Supply Brand	明伟 / 飞利浦 / 英飞特	
工作环境温度	Temperature of Working Condition	-25°C-50°C	
使用寿命	Life	>30000H	
防护等级	Protection Grade	IP 65	
灯具净重	Net Weight	17kg	17.5kg
外包装规格	Outside Box Specifications	900x410x130mm / 1pcs	

S0065-LED144

专利号 Num: 201320457480.5
201320453066.7

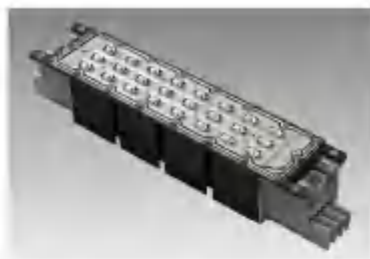
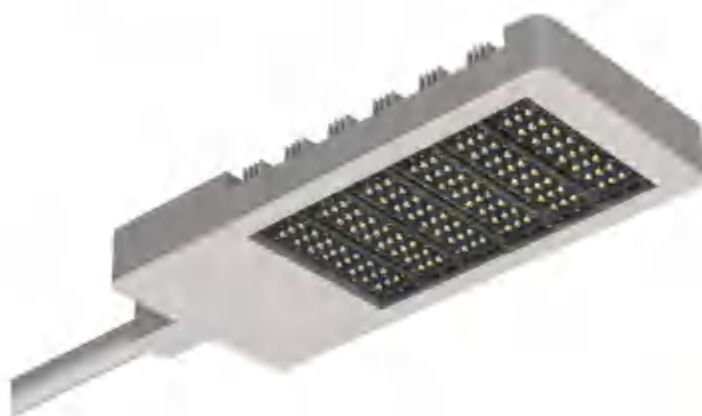

模块式和专业二次道路配光。
Modular and scientific optical lens design.



模块插拔式安装及更换。
Modular type installation and replacement.



独立的电源腔体和优质硅胶密封。
Independent power supply housing with high quality silicone rubber sealing.



电器腔锁扣式开合。
Buckle design for electric part housing.

适用场合

主要应用于主干道、城镇道路、快速路、省道、国道等。

The Application of Occasions

Suitable places: City main street, Highway, National highway and provincial highway.

产品特点说明

1. 极简的工业设计造型，美学与实用的完美结合，外观和结构专利。
2. 灯体主体部分采用高压压铸铝，表面双层静电喷塑处理，防腐性、抗老化，保证8年以上的使用寿命。
3. 直接光学透镜二次配光，无玻璃，大大提升整灯光效。
4. 独立的电源腔体并采用高效率、高稳定性恒流驱动电源，保证了光源的稳定工作，降低光衰，延长使用寿命。
5. 模块式独立散热，表面横向、纵向、垂直三向通风，加快散热。
6. 采用硅胶橡胶密封结构设计，有效保证了防护等级IP65。
7. 模块插拔式安装及拆卸维护，无需工具，使得装配和维护更为简便。

Product Description

1. Simple industrial design, perfect aesthetic and practical union, patented appearance and structure technology.
2. High pressure aluminium die-cast body, coated with outdoor used powder, double anti-corrosion to ensure 8 years long-life span.
3. Scientific optical lens design, without glass, greatly improve the luminous efficiency.
4. Independent power supply recessed design, using high efficiency and stability constant current driver to extend working life.
5. Modules design independent speed up heat dissipation.
6. Using silicone rubber leakproof structure design to ensure the high level of IP rating(IP:65).
7. Easy installation and maintenance with modules design.

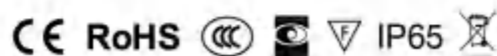

配光曲线 Light Distribution Curve

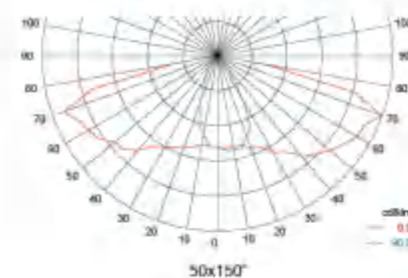

等照度图 Illumination Map

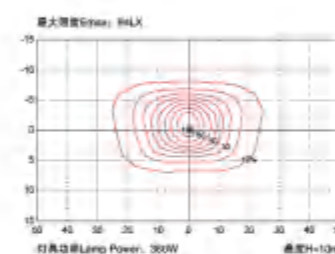

散热模拟图 Thermal Simulation Figure

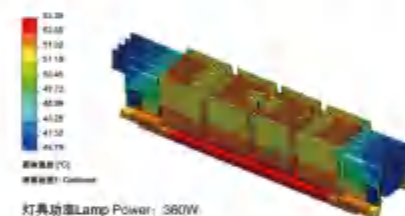

产品尺寸 Product Size

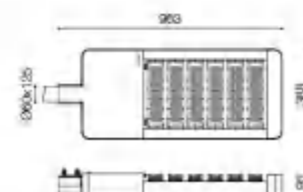

道路模拟 Simulation For Lighting on Road

类别	Performance	参数 Parameter	
额定功率	Rated Power	300W	340W
道路宽度(W)	Road Width	30 m	30 m
安装高度(1)	Installation Height	13 m	13 m
灯杆间距(L)	Lamp Pole Distance	45 m	45 m
突出(2)	Protruding Length	2.5 m	2.5 m
吊杆角度(3)	Hanging Pole Angle	15°	15°
维护系数	Maintenance Factor	0.8	0.8
平均照度	Average Illuminance	28 lx	32 lx
最大照度	Max illuminance	49 lx	56 lx
最小照度	Min illuminance	12 lx	13 lx
照度总均匀度	Uniformity of Illuminance	0.428	0.426
平均亮度	Average Luminance	2.21 cd/m ²	2.51 cd/m ²
总均匀度	Overall Uniformity	0.41 U _o	0.41 U _o
纵向均匀度	Longitudinal Uniformity	0.61 U _L	0.61 U _L
阈值增量	Threshold Increment	15% TI	15% TI
环境比	Surround Ratio	0.55 SR	0.55 SR



颜色选择 Color Selection

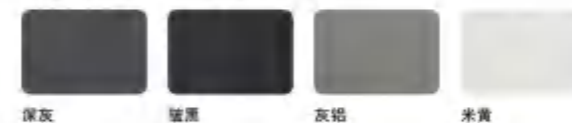

技术参数 Specification

类别	Product Code	参数 Parameter	
额定功率	Rated Power	300W	360W
输入电压	Input Voltage	90-305V AC	
频率范围	Frequency	50 / 60Hz	
功率因数	Power Factor	> 0.95	
光源 / 数量	LED Quantity	LED / 120pcs	
灯珠品牌	Brand	CREE	
色温	Color Temperature	3000K / 4000K / 5700K	
显色指数	Ra	≥ 70	
初始光通量	Initial Luminous Flux	30000 lm	34200 lm
整灯光效	Luminous Efficacy	100 lm/w	95 lm/w
电源品牌	Power Supply Brand	明伟 / 飞利浦 / 英飞特	
工作环境温度	Temperature of Working Condition	-25°C-50°C	
使用寿命	Life	>30000H	
防护等级	Protection Grade	IP 65	
灯具净重	Net Weight	22kg	
外包装规格	Outside Box Specifications	990x410x130mm / 1pcs	

灯杆配型 The style of the pole

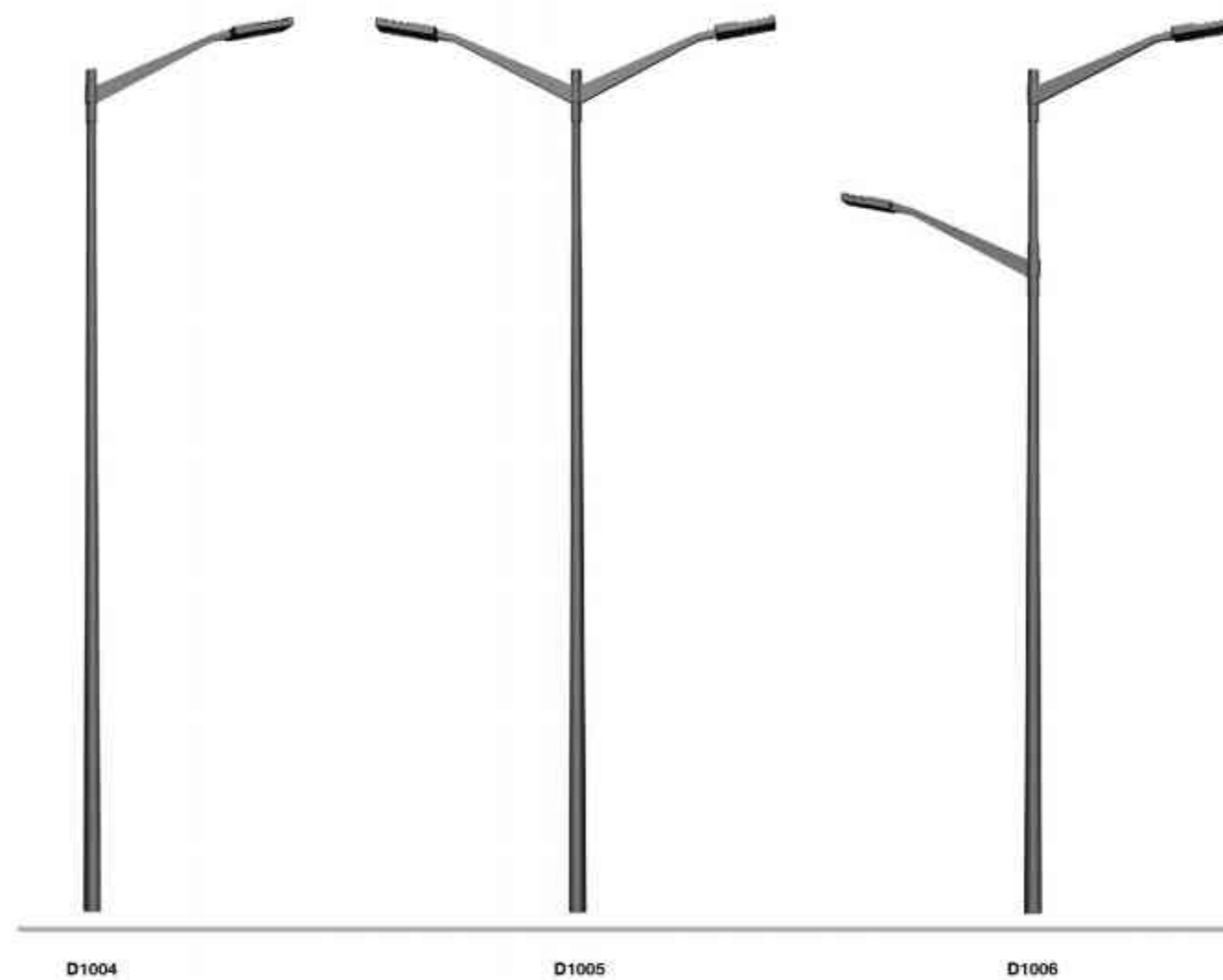
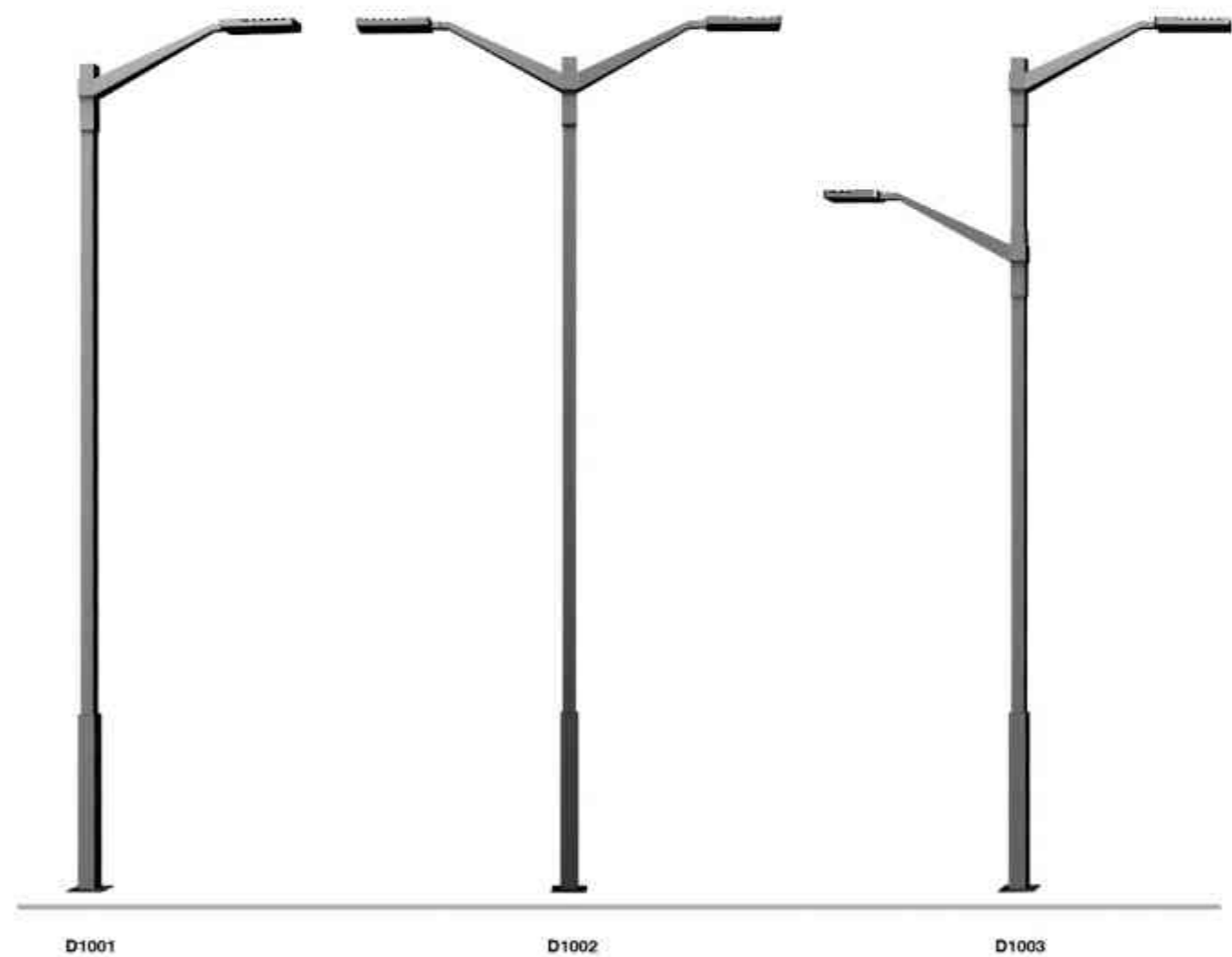

S0093 Series

专利号 Num: 201230154187.2
201220267939.0



S0093-LED126

S0093-HID250

适用场合

主要应用于城镇主干路、快速路、省道、国道等。

The Application of Occasions

Suitable places: City main street, Highway, National highway and provincial highway, etc.

产品特点说明

1. 经典的工业设计造型，美学与实用的完美结合，外观和结构专利。
2. 灯体主体部分采用高压压铸铝，表面静电喷塑双层处理，防腐蚀、抗老化，保证8年以上的使用寿命。
3. 灯体上面设计有起伏筋，增添美感，提高强度。
4. 反射器采用二次光学配光设计，整体冲压成型，材料采用进口铝板，表面喷砂真空镀膜处理，提高反射效率。
5. 采用蝙蝠翼形配光、矩形光斑设计，保证绝大部分光被投射到道路上，提高利用率，并有效保证了道路光照的均匀度。
6. 透光罩采用钢化超白玻璃，更有效的提高了光的透射率。
7. 采用硅橡胶密封结构设计，有效保证了防护等级IP65。
8. 采用型材扣罩设计、独特的转轴和撑杆设计，使用维修更加方便。

Product Description

1. Classical industrial design, Perfect aesthetic and practical union, patented appearance and structure technology.
2. High pressure Aluminium die-cast body, coated with outdoor used powder, double anti-corrosion to ensure 8 year long-life span.
3. Reinforcement design on the light body, increase the strength of the body.
4. Imported Aluminium reflector, sand blasted surface and vacuum coated, improve the reflection efficiency.
5. Using Bat-wings light and rectangular spot design, effectively ensure the light evenness of the road.
6. Ultrawhite tempered glass diffuser, effectively improve the transmission rate of light.
7. Using silicone rubber leakproof structure design to ensure the high level of IP rating (IP:65).
8. Special buckle, hinge and brace rod design, convenient for repair.



模块式光源。
Modular light source.



敞开式光源壳体，折叠式钣金撑杆。
Open-type light source with high quality aluminium reflector.

配光曲线 Light Distribution Curve

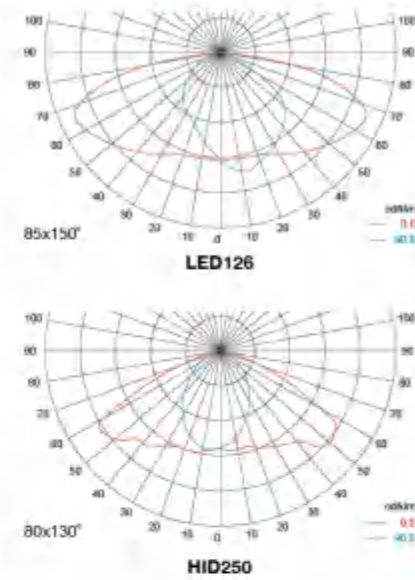

等照度图 Illumination Map

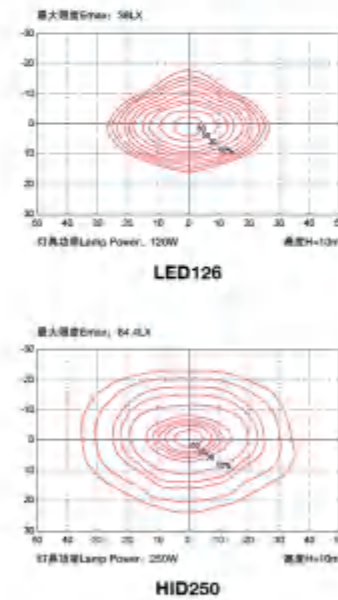

道路模拟 Simulation For Lighting on Road

类别	Performance	参数 Parameter	
额定功率	Rated Power	120W	250W
道路宽度(W)	Road Width	15 m	15 m
安装高度(1)	Installation Height	10 m	10 m
灯杆间距(L)	Lamp Pole Distance	30 m	30 m
突出(2)	Protruding Length	1 m	1 m
吊杆角度(3)	Hanging Pole Angle	15°	15°
维护系数	Maintenance Factor	0.8	0.8
平均照度	Average Illuminance	31 lx	32 lx
最大照度	Max illuminance	38 lx	44 lx
最小照度	Min illuminance	22 lx	19 lx
照度总均匀度	Uniformity of Illuminance	0.692	0.585
平均亮度	Average Luminance	2.14 cd/m ²	1.73 cd/m ²
总均匀度	Overall Uniformity	0.58 Uo	0.61 Uo
纵向均匀度	Longitudinal Uniformity	0.72 UL	0.62 UL
阈值增量	Threshold Increment	12% TI	5% TI
环境比	Surround Ratio	0.61 SR	0.53 SR



颜色选择 Color Selection

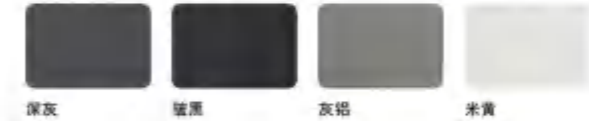

技术参数 Specification

类别	Product Code	参数 Parameter	
额定功率	Rated Power	120W	250W
输入电压	Input Voltage	90-305V AC	AC 220V
频率范围	Frequency	50 / 60Hz	50 / 60Hz
功率因数	Power Factor	> 0.95	> 0.9
光源 / 数量	Light Source / Quantity	LED / 126pcs	E40 / 1pcs
灯具品牌	Brand	Lumileds	飞利浦
色温	Color Temperature	3000K / 4000K / 5700K	2000K
显色指数	Ra	≥ 70	≥ 25
初始光通量	Initial Luminous Flux	12600 lm	33200 lm
整灯光效	Luminous Efficacy	105 lm/w	128 lm/w
电源品牌	Power Supply Brand	飞利浦 / 英飞特 / 茂硕	飞利浦
工作环境温度	Temperature of Working Condition	-25°C-50°C	-25°C-50°C
使用寿命	Life	>30000H	>8000H
防护等级	Protection Grade	IP 65	IP 65
灯具净重	Net Weight	11.5kg	9kg
外箱规格	Outside Box Specifications	810x305x190mm / 1pcs	

产品尺寸 Product Size

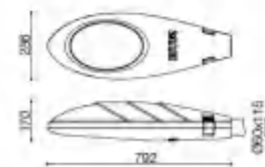

S0104B Series

专利号 Num: 201230154182.X
201220267939.0



S0104-LED189

S0104B-HID400

适用场合

主要应用于城镇主干路、快速路、省道、国道等。

The Application of Occasions

Suitable places: City main street, Highway, National highway and provincial highway, etc.

产品特点说明

1. 经典的工业设计造型，美学与实用的完美结合，外观和结构专利。
2. 灯体主体部分采用高压压铸铝，表面静电喷塑双层处理，防腐蚀、抗老化，保证8年以上的使用寿命。
3. 灯体上面设计有起伏筋，增添美感，提高强度。
4. 反射器采用二次光学配光设计，整体冲压成型，材料采用进口铝板，表面喷砂真空镀膜处理，提高反射效率。
5. 采用蝙蝠翼形配光、矩形光斑设计，保证绝大部分光被投射到道路上，提高利用率，并有效保证了道路光照的均匀度。
6. 透光罩采用钢化超白玻璃，更有效的提高了光的透射率。
7. 采用硅橡胶密封结构设计，有效保证了防护等级IP65。
8. 采用型材扣罩设计、独特的转轴和撑杆设计，使用维修更加方便。

Product Description

1. Classical industrial design, Perfect aesthetic and practical union, patented appearance and structure technology.
2. High pressure Aluminium die-cast body, coated with outdoor used powder, double anti-corrosion to ensure 8 year long-life span.
3. Reinforcement design on the light body, increase the strength of the body.
4. Imported Aluminium reflector, sand blasted surface and vacuum coated, improve the reflection efficiency.
5. Using Bat-wings light and rectangular spot design, effectively ensure the light evenness of the road.
6. Ultrawhite tempered glass diffuser, effectively improve the transmission rate of light.
7. Using silicone rubber leakproof structure design to ensure the high level of IP rating (IP:65).
8. Special buckle, hinge and brace rod design, convenient for repair.



模块式光源。
Modular light source.



封闭式光源壳体，折叠式钣金撑杆。
Close-type light source with high quality aluminium reflector.

配光曲线 Light Distribution Curve

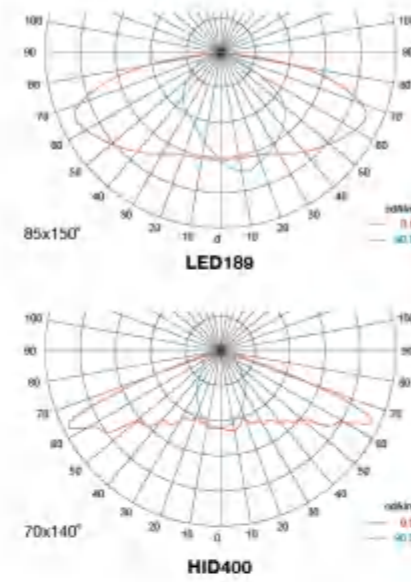

等照度图 Illumination Map

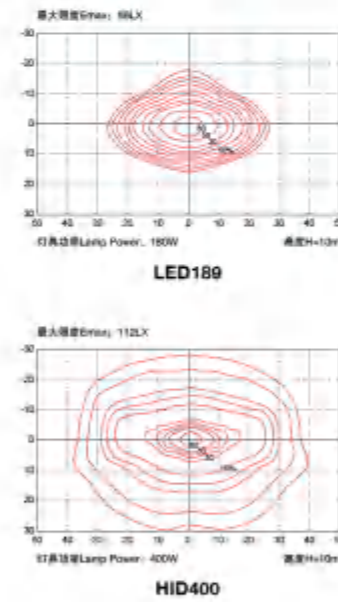

道路模拟 Simulation For Lighting on Road

类别	Performance	参数 Parameter	
额定功率	Rated Power	180W	400W
道路宽度(W)	Road Width	22.5 m	22.5 m
安装高度(1)	Installation Height	12 m	12 m
灯杆间距(L)	Lamp Pole Distance	40 m	40 m
突出(2)	Protruding Length	2.5 m	2.5 m
吊杆角度(3)	Hanging Pole Angle	15°	15°
维护系数	Maintenance Factor	0.8	0.8
平均照度	Average Illuminance	25 lx	40 lx
最大照度	Max illuminance	31 lx	64 lx
最小照度	Min illuminance	16 lx	28 lx
照度总均匀度	Uniformity of Illuminance	0.626	0.703
平均亮度	Average Luminance	1.69 cd/m ²	2.59 cd/m ²
总均匀度	Overall Uniformity	0.48 Uo	0.53 Uo
纵向均匀度	Longitudinal Uniformity	0.61 UL	0.61 UL
阈值增量	Threshold Increment	12% TI	10% TI
环境比	Surround Ratio	0.54 SR	0.62 SR

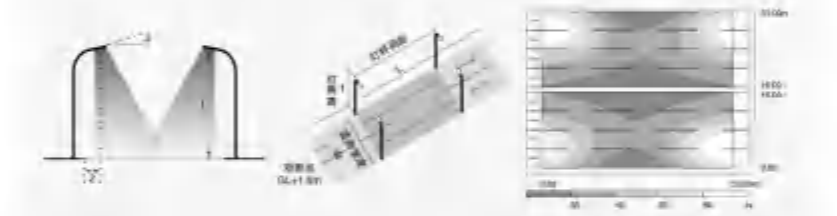

颜色选择 Color Selection

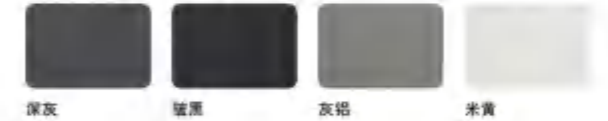

技术参数 Specification

类别	Product Code	参数 Parameter	
额定功率	Rated Power	180W	400W
输入电压	Input Voltage	90-305V AC	AC 220V
频率范围	Frequency	50 / 60Hz	50 / 60Hz
功率因数	Power Factor	> 0.95	> 0.9
光源 / 数量	Light Source / Quantity	LED / 189pcs	E40 / 1pcs
灯珠品牌	Brand	Lumileds	飞利浦
色温	Color Temperature	3000K / 4000K / 5700K	2000K
显色指数	Ra	≥ 70	≥ 25
初始光通量	Initial Luminous Flux	18900 lm	56500 lm
整灯光效	Luminous Efficacy	105 lm/w	138 lm/w
电源品牌	Power Supply Brand	飞利浦 / 英飞特 / 茂硕	飞利浦
工作环境温度	Temperature of Working Condition	-25°C~50°C	-25°C~50°C
使用寿命	Life	>30000H	>8000H
防护等级	Protection Grade	IP 65	IP 65
灯具净重	Net Weight	14kg	11kg
外箱规格	Outside Box Specifications	1070x400x300mm / 1pcs	

产品尺寸 Product Size

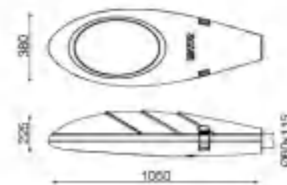

S0116 Series

专利设计 DESIGN PATENT



适用场合

主要应用于城镇主干路、快速路、省道、国道等。

The Application of Occasions

Suitable places: City main street, Highway, National highway and provincial highway, etc.

产品特点说明

1. 经典的工业设计造型，美学与实用的完美结合，外观和结构专利。
2. 灯体主体部分采用高压压铸铝，表面静电喷塑双层处理，防腐蚀、抗老化，保证8年以上的使用寿命。
3. 灯体上面设计有起伏筋，增添美感，提高强度。
4. 反射器采用二次光学配光设计，整体冲压成型，材料采用进口铝板，表面喷砂真空镀膜处理，提高反射效率。
5. 采用蝙蝠翼形配光、矩形光斑设计，保证绝大部分光被投射到道路上，提高利用率，并有效保证了道路光照的均匀度。
6. 透光罩采用钢化超白玻璃，更有效的提高了光的透射率。
7. 采用硅橡胶密封结构设计，有效保证了防护等级IP65。
8. 采用型材扣罩设计、独特的转轴和撑杆设计，使用维修更加方便。

Product Description

1. Classical industrial design, Perfect aesthetic and practical union, patented appearance and structure technology.
2. High pressure Aluminium die-cast body, coated with outdoor used powder, double anti-corrosion to ensure 8 year long-life span.
3. Reinforcement design on the light body, increase the strength of the body.
4. Imported Aluminium reflector, sand blasted surface and vacuum coated, improve the reflection efficiency.
5. Using Bat-wings light and rectangular spot design, effectively ensure the light evenness of the road.
6. Ultrawhite tempered glass diffuser, effectively improve the transmission rate of light.
7. Using silicone rubber leakproof structure design to ensure the high level of IP rating (IP:65).
8. Special buckle, hinge and brace rod design, convenient for repair.

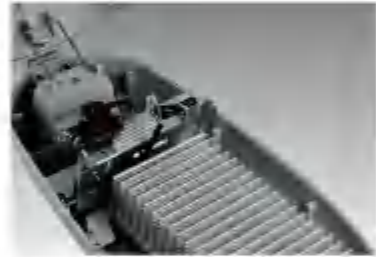

铝合金型材散热。
Aluminum alloy profiles.



封闭式光源壳体，优质铝反光罩。
Close-type light source with high quality aluminium reflector.

CE RoHS CCC IP65

配光曲线 Light Distribution Curve

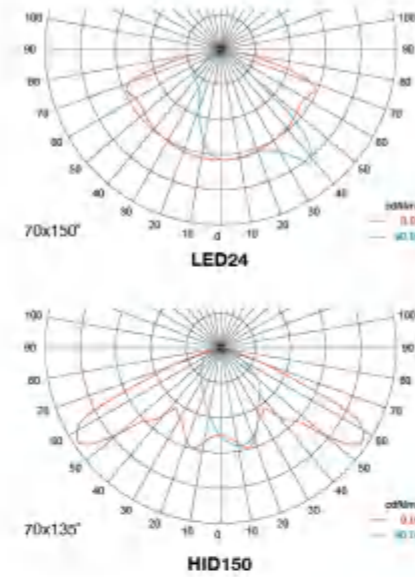

等照度图 Illumination Map

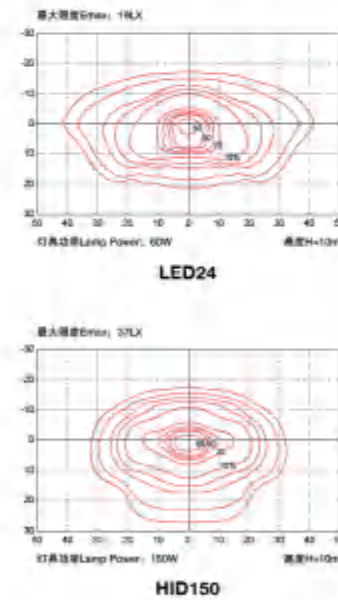

产品尺寸 Product Size

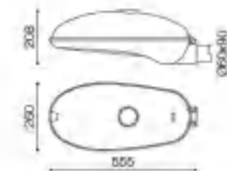

道路模拟 Simulation For Lighting on Road

类别	Performance	参数 Parameter	
额定功率	Rated Power	60W	150W
道路宽度(W)	Road Width	7.5m	7.5m
安装高度(1)	Installation Height	8 m	8 m
灯杆间距(L)	Lamp Pole Distance	24 m	24 m
突出(2)	Protruding Length	0.5 m	0.5 m
吊杆角度(3)	Hanging Pole Angle	0°	0°
维护系数	Maintenance Factor	0.8	0.8
平均照度	Average Illuminance	27 lx	53 lx
最大照度	Max illuminance	40 lx	78 lx
最小照度	Min illuminance	17 lx	38 lx
照度总均匀度	Uniformity of Illuminance	0.637	0.720
平均亮度	Average Luminance	1.57 cd/m ²	3.10 cd/m ²
总均匀度	Overall Uniformity	0.89 U _o	0.69 U _o
纵向均匀度	Longitudinal Uniformity	0.89 U _L	0.61 U _L
阈值增量	Threshold Increment	5% TI	2% TI
环境比	Surround Ratio	0.61 SR	0.52 SR



颜色选择 Color Selection

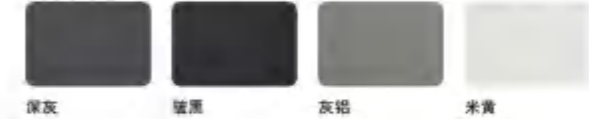

技术参数 Specification

类别	Product Code	参数 Parameter	
额定功率	Rated Power	60W	150W
输入电压	Input Voltage	90-305V AC	AC 220V
频率范围	Frequency	50 / 60Hz	50 / 60Hz
功率因数	Power Factor	> 0.95	> 0.9
光源 / 数量	Light Source / Quantity	LED / 24pcs	E40 / 1pcs
灯珠品牌	Brand	CREE	飞利浦
色温	Color Temperature	3000K / 4000K / 5700K	2000K
显色指数	Ra	≥ 70	≥ 20
初始光通量	Initial Luminous Flux	5700 lm	18000 lm
整灯光效	Luminous Efficacy	95 lm/w	117 lm/w
电源品牌	Power Supply Brand	明伟 / 飞利浦 / 英飞特	飞利浦
工作环境温度	Temperature of Working Condition	-25°C~50°C	-25°C~50°C
使用寿命	Life	>30000H	>8000H
防护等级	Protection Grade	IP 65	IP 65
灯具净重	Net Weight	5kg	3.5kg
外箱规格	Outside Box Specifications	580x275x225mm / 1pcs	

S0117 Series

专利设计 DESIGN PATENT



S0117-LED48

S0117-HID250

适用场合

主要应用于城镇主干路、快速路、省道、国道等。

The Application of Occasions

Suitable places: City main street, Highway, National highway and provincial highway, etc.

产品特点说明

1. 经典的工业设计造型，美学与实用的完美结合，外观和结构专利。
2. 灯体主体部分采用高压压铸铝，表面静电喷塑双层处理，防腐蚀、抗老化，保证8年以上的使用寿命。
3. 灯体上面设计有起伏筋，增添美感，提高强度。
4. 反射器采用二次光学配光设计，整体冲压成型，材料采用进口铝板，表面喷砂真空镀膜处理，提高反射效率。
5. 采用蝙蝠翼形配光、矩形光斑设计，保证绝大部分光被投射到道路上，提高利用率，并有效保证了道路光照的均匀度。
6. 透光罩采用钢化超白玻璃，更有效的提高了光的透射率。
7. 采用硅橡胶密封结构设计，有效保证了防护等级IP65。
8. 采用型材扣罩设计、独特的转轴和撑杆设计，使用维修更加方便。

Product Description

1. Classical industrial design, Perfect aesthetic and practical union, patented appearance and structure technology.
2. High pressure Aluminium die-cast body, coated with outdoor used powder, double anti-corrosion to ensure 8 year long-life span.
3. Reinforcement design on the light body, increase the strength of the body.
4. Imported Aluminium reflector, sand blasted surface and vacuum coated, improve the reflection efficiency.
5. Using Bat-wings light and rectangular spot design, effectively ensure the light evenness of the road.
6. Ultrawhite tempered glass diffuser, effectively improve the transmission rate of light.
7. Using silicone rubber leakproof structure design to ensure the high level of IP rating (IP:65).
8. Special buckle, hinge and brace rod design, convenient for repair.



铝合金型材散热。
Aluminum alloy profiles.



封闭式光源壳体，优质铝反光罩。
Close-type light source with high quality aluminium reflector.

配光曲线 Light Distribution Curve

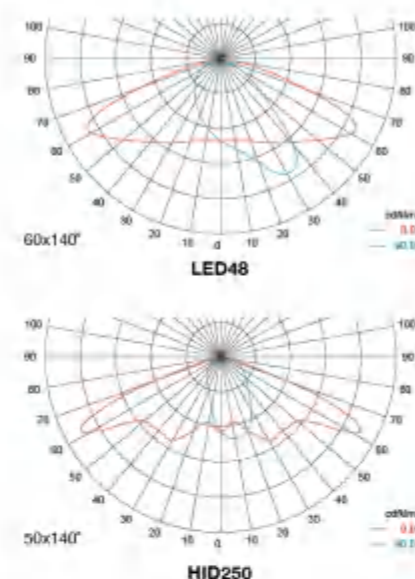

等照度图 Illumination Map

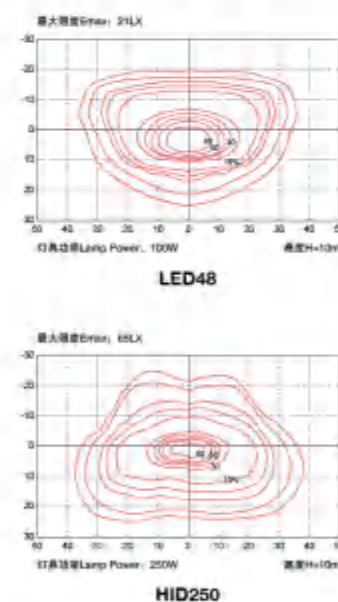

道路模拟 Simulation For Lighting on Road

类别	Performance	参数 Parameter	
额定功率	Rated Power	100W	250W
道路宽度(W)	Road Width	15m	15m
安装高度(1)	Installation Height	10 m	10 m
灯杆间距(L)	Lamp Pole Distance	30 m	30 m
突出(2)	Protruding Length	1 m	1 m
吊杆角度(3)	Hanging Pole Angle	15°	15°
维护系数	Maintenance Factor	0.8	0.8
平均照度	Average Illuminance	21 lx	40 lx
最大照度	Max illuminance	27 lx	59 lx
最小照度	Min illuminance	15 lx	27 lx
照度总均匀度	Uniformity of Illuminance	0.711	0.663
平均亮度	Average Luminance	1.16 cd/m ²	2.25 cd/m ²
总均匀度	Overall Uniformity	0.63 U _o	0.55 U _o
纵向均匀度	Longitudinal Uniformity	0.67 U _L	0.61 U _L
阈值增量	Threshold Increment	4% TI	6% TI
环境比	Surround Ratio	0.58 SR	0.52 SR

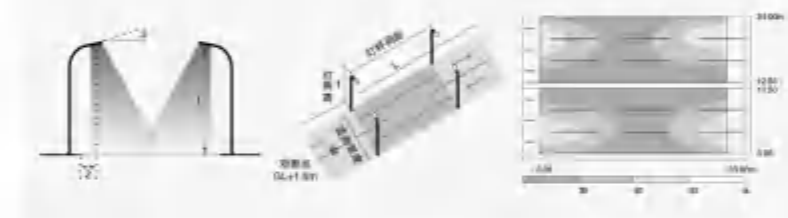

颜色选择 Color Selection

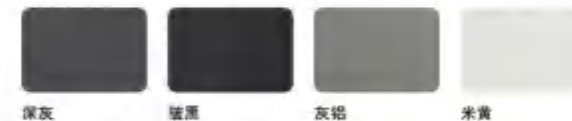

技术参数 Specification

类别	Product Code	参数 Parameter	
额定功率	Rated Power	100W	250W
输入电压	Input Voltage	90-305V AC	AC 220V
频率范围	Frequency	50 / 60Hz	50 / 60Hz
功率因数	Power Factor	> 0.95	> 0.9
光源 / 数量	Light Source / Quantity	LED / 48pcs	E40 / 1pcs
灯珠品牌	Brand	CREE	飞利浦
色温	Color Temperature	3000K / 4000K / 5700K	2000K
显色指数	Ra	≥ 70	≥ 25
初始光通量	Initial Luminous Flux	9500 lm	33200 lm
整灯光效	Luminous Efficacy	95 lm/w	128 lm/w
电源品牌	Power Supply Brand	明伟 / 飞利浦 / 英飞特	飞利浦
工作环境温度	Temperature of Working Condition	-25°C~50°C	-25°C~50°C
使用寿命	Life	>30000H	>8000H
防护等级	Protection Grade	IP 65	IP 65
灯具净重	Net Weight	6.8kg	4.8kg
外箱规格	Outside Box Specifications	695x310x255mm / 1pcs	

产品尺寸 Product Size

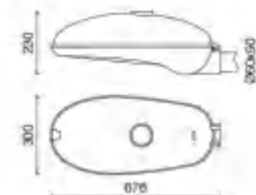

灯杆配型 The style of the pole

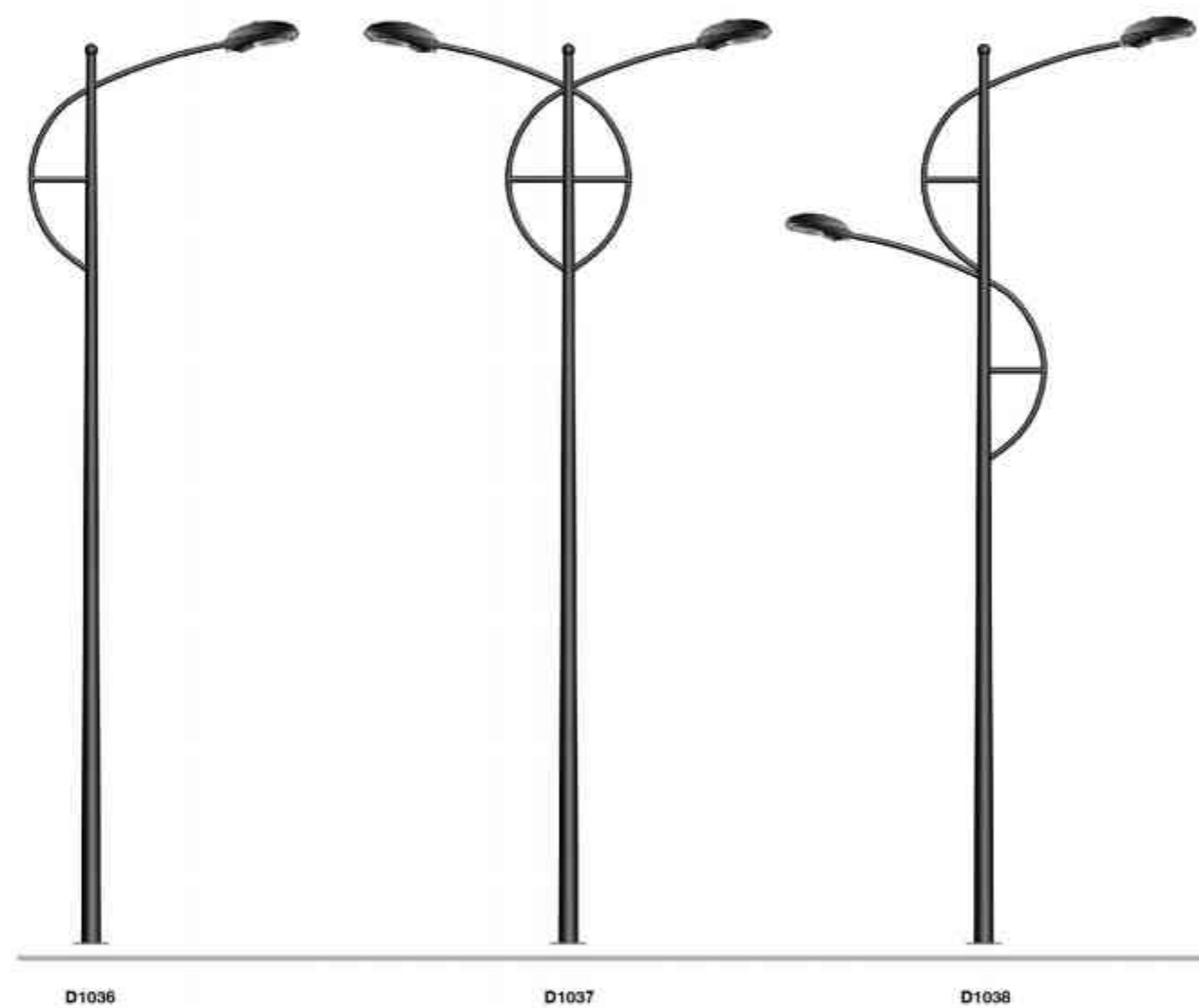
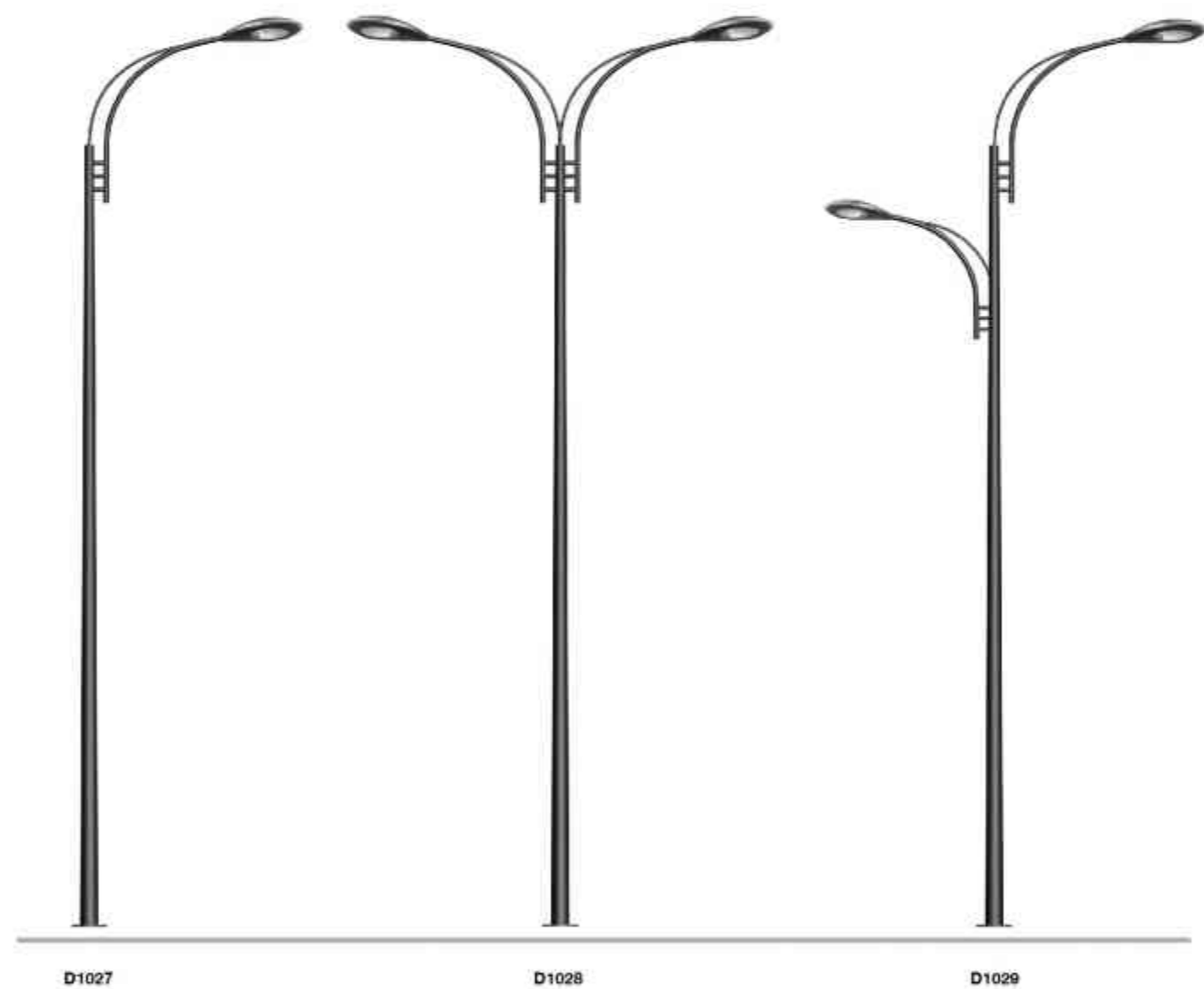

S0095A Series

专利设计 DESIGN PATENT



适用场合

主要应用于城镇主干路、快速路、省道、国道等。

The Application of Occasions

Suitable places: City main street, Highway, National highway and provincial highway, etc.

产品特点说明

1. 经典的工业设计造型，美学与实用的完美结合。
2. 灯体主体部分采用高压压铸铝，表面双层静电喷塑处理，防腐蚀、抗老化，保证8年以上的使用寿命。
3. 二次光学透镜配光，满足庭院和道路照明的需求。
4. 透光罩采用超白钢化玻璃，提高整灯光效。
5. 采用硅橡胶密封结构设计，有效保证了防护等级IP65。
6. 多种安装方式，满足不同效果和场合的使用。
7. 按钮式开盖和安全防拉绳，维修简便。

Product Description

1. Classical industrial design, perfect aesthetic and practical union.
2. High pressure aluminium die-cast body, coated with outdoor used powder, double anti-corrosion to ensure 8 years long-life span.
3. Scientific optical lens design to satisfies the illumination requests of yard and road.
4. Ultrawhite tempered glass diffuser, improve the luminous efficiency.
5. Using silicone rubber leakproof structure design to ensure the high level of IP rating(IP:65).
6. Multiple installations to satisfy the uses of different effects and places.
7. Button design and safety rope is convenient for repair.



专业二次道路配光。
Scientific secondary light distribution.



封闭式光源壳体，优质铝反光罩。
Close-type light source with high quality aluminium reflector.

配光曲线 Light Distribution Curve

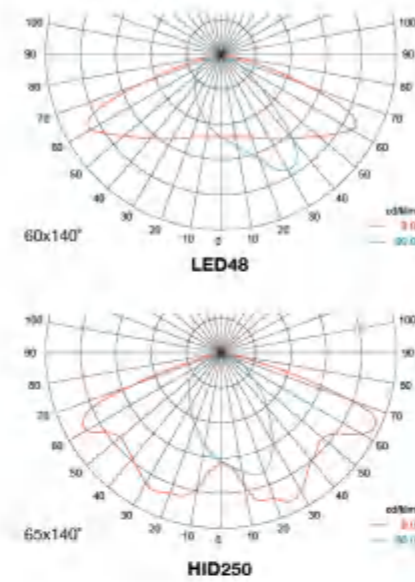

道路模拟 Simulation For Lighting on Road

类别	Performance	参数 Parameter	
额定功率	Rated Power	100W	250W
道路宽度(W)	Road Width	15m	15m
安装高度(H)	Installation Height	10 m	10 m
灯杆间距(L)	Lamp Pole Distance	30 m	30 m
突出(2)	Protruding Length	1 m	1 m
吊杆角度(3)	Hanging Pole Angle	15°	15°
维护系数	Maintenance Factor	0.8	0.8
平均照度	Average Illuminance	21 lx	44 lx
最大照度	Max illuminance	27 lx	69 lx
最小照度	Min illuminance	15 lx	25 lx
照度总均匀度	Uniformity of Illuminance	0.711	0.565
平均亮度	Average Luminance	1.16 cd/m ²	2.56 cd/m ²
总均匀度	Overall Uniformity	0.63 U _o	0.65 U _o
纵向均匀度	Longitudinal Uniformity	0.67 U _L	0.72 U _L
阈值增量	Threshold Increment	4% TI	8% TI
环境比	Surround Ratio	0.58 SR	0.52 SR



等照度图 Illumination Map

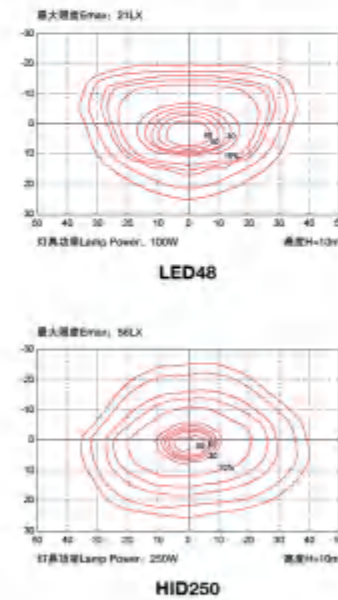

颜色选择 Color Selection

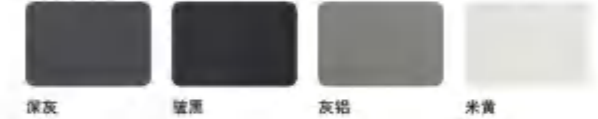

技术参数 Specification

类别	Product Code	参数 Parameter	
额定功率	Rated Power	100W	250W
输入电压	Input Voltage	90-305V AC	AC 220V
频率范围	Frequency	50 / 60Hz	50 / 60Hz
功率因数	Power Factor	> 0.95	> 0.9
光源 / 数量	Light Source / Quantity	LED / 48pcs	E40 / 1pcs
灯珠品牌	Brand	CREE	飞利浦
色温	Color Temperature	3000K / 4000K / 5700K	2000K
显色指数	Ra	≥ 70	≥ 25
初始光通量	Initial Luminous Flux	9500 lm	33200 lm
整灯光效	Luminous Efficacy	95 lm/w	128 lm/w
电源品牌	Power Supply Brand	明伟 / 飞利浦 / 英飞特	飞利浦
工作环境温度	Temperature of Working Condition	-25°C~50°C	-25°C~50°C
使用寿命	Life	>30000H	>8000H
防护等级	Protection Grade	IP 65	IP 65
灯具净重	Net Weight	12.6kg	10kg
外箱规格	Outside Box Specifications	570x570x245mm / 1pcs	

产品尺寸 Product Size

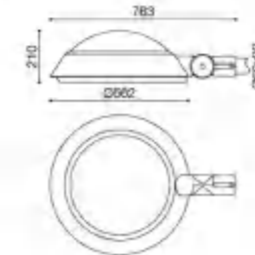

S0095C Series

专利设计 DESIGN PATENT



适用场合

主要应用于城镇主干路、快速路、省道、国道等。

The Application of Occasions

Suitable places: City main street, Highway, National highway and provincial highway, etc.

产品特点说明

1. 经典的工业设计造型，美学与实用的完美结合。
2. 灯体主体部分采用高压压铸铝，表面双层静电喷塑处理，防腐蚀、抗老化，保证8年以上的使用寿命。
3. 二次光学透镜配光，满足庭院和道路照明的需求。
4. 透光罩采用超白钢化玻璃，提高整灯光效。
5. 采用硅橡胶密封结构设计，有效保证了防护等级IP65。
6. 多种安装方式，满足不同效果和场合的使用。
7. 按钮式开盖和安全防拉绳，维修简便。

Product Description

1. Classical industrial design, perfect aesthetic and practical union.
2. High pressure aluminium die-cast body, coated with outdoor used powder, double anti-corrosion to ensure 8 years long-life span.
3. Scientific optical lens design to satisfies the illumination requests of yard and road.
4. Ultrawhite tempered glass diffuser, improve the luminous efficiency.
5. Using silicone rubber leakproof structure design to ensure the high level of IP rating(IP:65).
6. Multiple installations to satisfy the uses of different effects and places.
7. Button design and safety rope is convenient for repair.



专业二次道路配光。
Scientific secondary light distribution.



封闭式光源壳体，优质铝反光罩。
Close-type light source with high quality aluminium reflector.

配光曲线 Light Distribution Curve

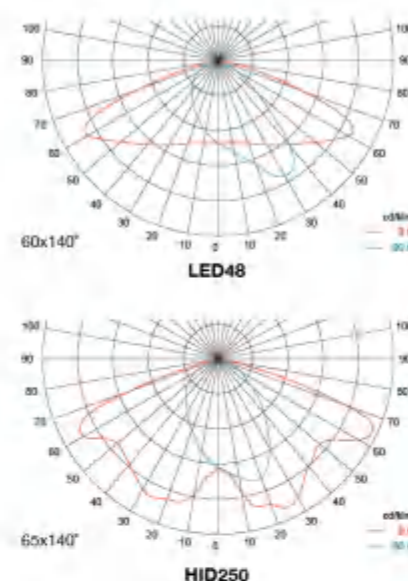

道路模拟 Simulation For Lighting on Road

类别	Performance	参数 Parameter	
额定功率	Rated Power	100W	250W
道路宽度(W)	Road Width	15m	15m
安装高度(1)	Installation Height	10 m	10 m
灯杆间距(L)	Lamp Pole Distance	30 m	30 m
突出(2)	Protruding Length	1 m	1 m
吊杆角度(3)	Hanging Pole Angle	15°	15°
维护系数	Maintenance Factor	0.8	0.8
平均照度	Average Illuminance	21 lx	44 lx
最大照度	Max illuminance	27 lx	69 lx
最小照度	Min illuminance	15 lx	25 lx
照度总均匀度	Uniformity of Illuminance	0.711	0.565
平均亮度	Average Luminance	1.16 cd/m ²	2.56 cd/m ²
总均匀度	Overall Uniformity	0.63 U _o	0.65 U _o
纵向均匀度	Longitudinal Uniformity	0.67 U _L	0.72 U _L
阈值增量	Threshold Increment	4% TI	8% TI
环境比	Surround Ratio	0.58 SR	0.52 SR



等照度图 Illumination Map

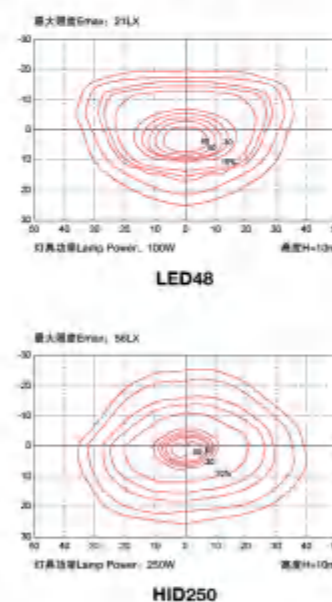

颜色选择 Color Selection

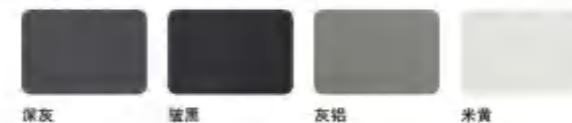

技术参数 Specification

类别	Product Code	参数 Parameter	
额定功率	Rated Power	100W	250W
输入电压	Input Voltage	90-305V AC	AC 220V
频率范围	Frequency	50 / 60Hz	50 / 60Hz
功率因数	Power Factor	> 0.95	> 0.9
光源 / 数量	Light Source / Quantity	LED / 48pcs	E40 / 1pcs
灯珠品牌	Brand	CREE	飞利浦
色温	Color Temperature	3000K / 4000K / 5700K	2000K
显色指数	Ra	≥ 70	≥ 25
初始光通量	Initial Luminous Flux	9500 lm	33200 lm
整灯光效	Luminous Efficacy	95 lm/w	128 lm/w
电源品牌	Power Supply Brand	明伟 / 飞利浦 / 英飞特	飞利浦
工作环境温度	Temperature of Working Condition	-25°C~50°C	-25°C~50°C
使用寿命	Life	>30000H	>8000H
防护等级	Protection Grade	IP 65	IP 65
灯具净重	Net Weight	11kg	10kg
外箱规格	Outside Box Specifications	570x570x245mm / 1pcs	

产品尺寸 Product Size



灯杆配型 The style of the pole

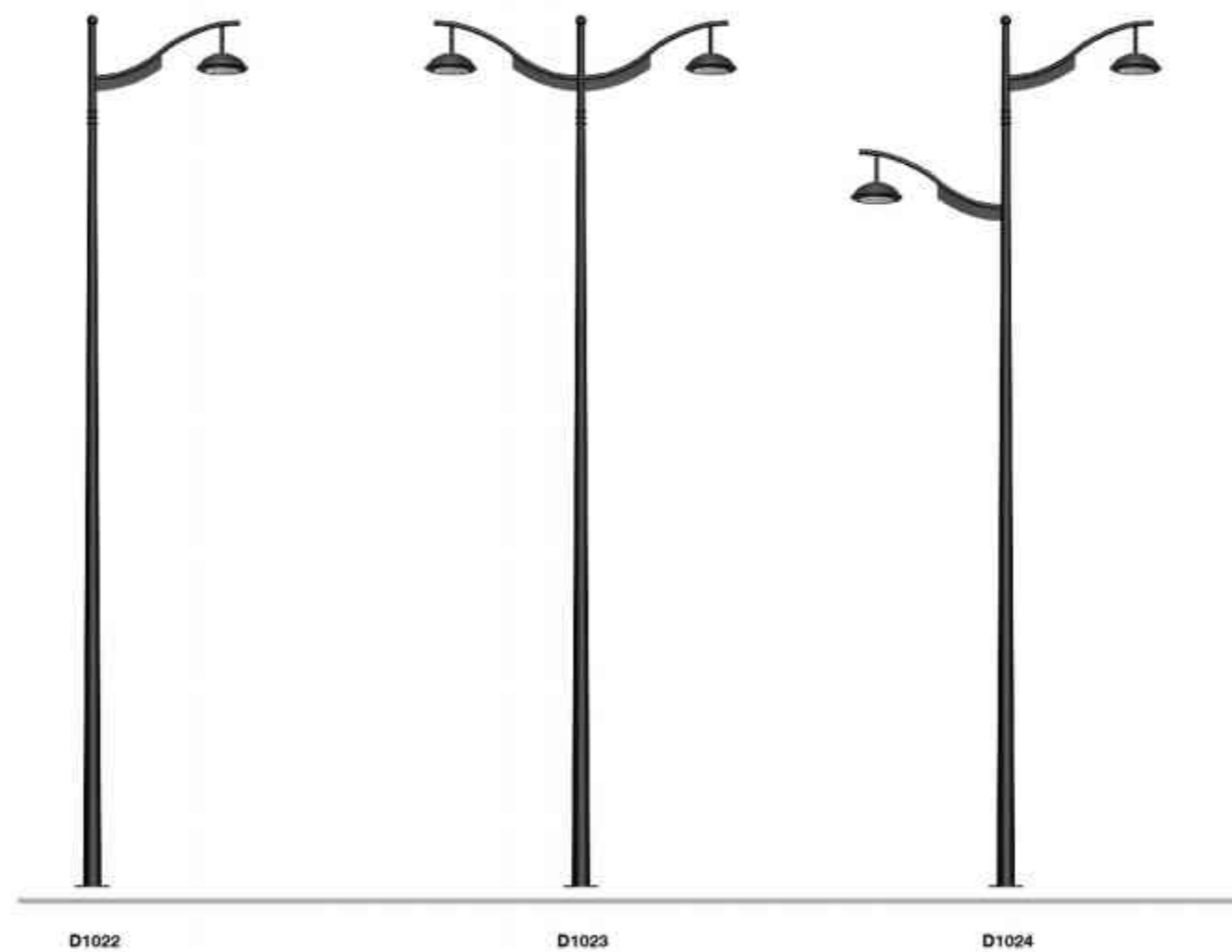
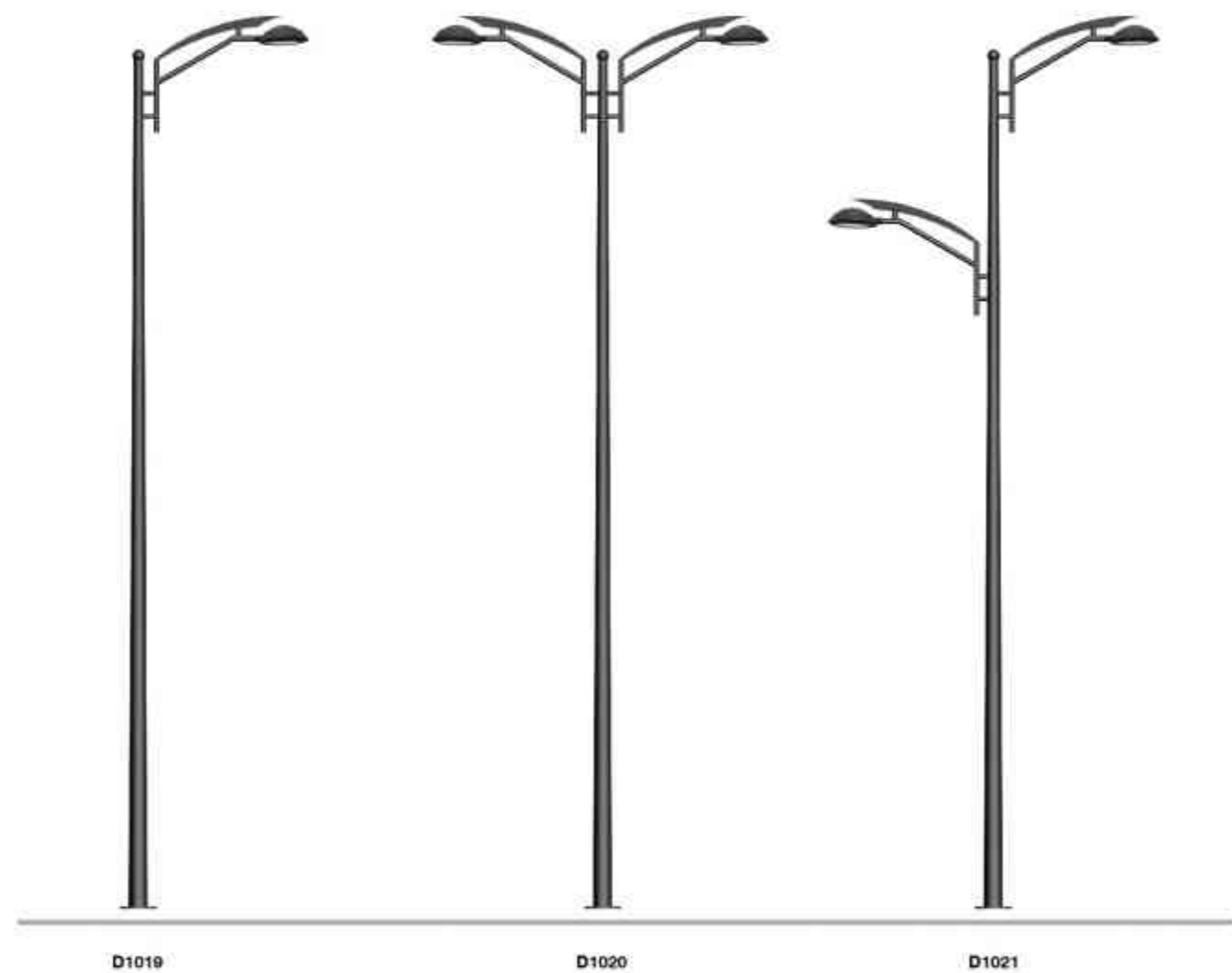

L0005 贝泰之星

专利号 Num: 201521094466.9 201521094463.5 201521094477.7
201521094479.6 201521094480.9 201530559377.6



产品尺寸 Product Size

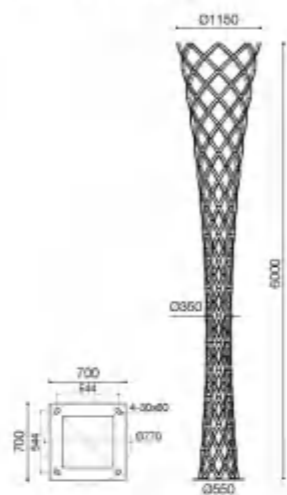

适用场合

主要应用于广场、公园、步行街等。

The Application of Occasions

Suitable places: Square, Park, Pedestrian, etc.

产品特点说明

1. 整灯采用浇铸钢件模块，拼接而成。
2. 中间金属主杆加强，内外热镀锌，表面喷漆，抗风等级达到12级。
3. 镂空菱形框设计，大大降低风阻，提升安全系数。
4. 采用LED模块光源，融入DMX512控制系统，实现多种动画效果。
5. 焊接工艺：高强度氩弧焊整体焊接。
6. 表面工艺：粗磨-热镀锌-粗磨-细磨-精磨-喷塑。
7. 景观灯整体比例恰当，工艺完美，造型美观大方，质感强烈。

Product Description

1. The whole lamp adopts steel casting module, splicing.
2. Strengthen the middle metal main pole, inside and outside the hot galvanized, plastic sprayed surfaces, the wind reached level 12.
3. The hollow diamond frame design, greatly reduce the air resistance, improve safety coefficient.
4. Using LED module light source, into the DMX512 control system, to achieve a variety of animation effects.
5. Welding process: high strength argon arc welding.
6. Surface technology: coarse grinding - hot dip galvanized - coarse grinding fine grinding grinding - spray.
7. The overall proportion of landscape lamps appropriate, perfect technology, beautiful appearance generous, strong texture.



CE RoHS CCC IP65

技术参数 Specification

类别	Product Code	参数 Parameter
额定功率	Rated Power	180W
输入电压	Input Voltage	90-305V AC
频率范围	Frequency	50 / 60Hz
功率因数	Power Factor	> 0.95
光源类型	Light Source Type	LED
光源品牌	Light Source Brand	CREE
色温	Color Temperature	3000K / 4000K / 5700K / RGB
控制方式	Control Mode	ON-OFF / DMX512 / SPI
电源品牌	Power Supply Brand	明伟
工作环境温度	Temperature of Working Condition	-25°C-50°C
使用寿命	Life	>30000H
防护等级	Protection Grade	IP 65

颜色选择 Color Selection

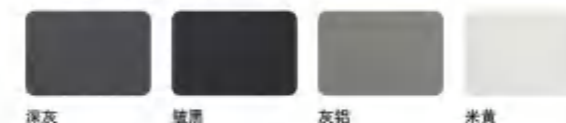

L0001 天眼

专利设计 DESIGN PATENT



产品尺寸 Product Size

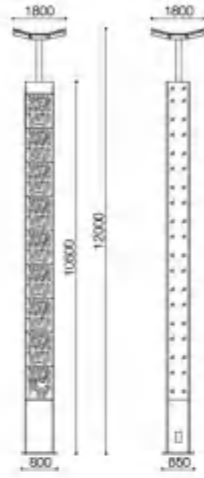

适用场合

主要应用于广场、公园、步行街等。

The Application of Occasions

Suitable places: Square, Park, Pedestrian, etc.

产品特点说明

1. 灯体主体采用金属龙骨架，内外热镀锌，表面喷塑，抗风等级达到12级风力。
2. 侧面1透光面采用水纹玻璃，光源采用LED点光源矩阵布置，配合外控形成流水效果。
3. 侧面2采用乳白PC板和不锈钢拉丝雕花面板包裹，光源采用LED数码管竖向排列布置，配合外控实现七彩变色效果，让雕花图案更加唯美。
4. 不锈钢雕花面板：花纹采用激光切割，确保切口平整、条纹整齐，线条清晰。
5. 不锈钢雕花面板表面处理：表面拉丝处理，纹路清晰。
6. 景观灯整体比例恰当，工艺完美，造型美观大方，质感强烈。

Product Description

1. Metal dragon light framework, inside and outside hot galvanized, powder coated, wind loading resistance up to 12 level.
2. Side 1: Using water wave glass, The light source adopts LED point light decorate, cooperate with external control matrix arrangement.
3. Side 2: Parcelled with opal PC plate and stainless steel wire-drawn carve plate, adopts LED digital light source on vertical arrangement, cooperate with external 7 color change control, makes the carve patterns more beautiful.
4. Stainless steel plate: Using laser cutting decorative pattern to ensure the laser cutting incision clear and stripe.
5. Stainless steel surface treatment: Wire-drawn finishment.
6. Perfect percentage of the whole lamp, strong simple sense.



CE RoHS CCC IP65

技术参数 Specification

类别	Product Code	参数 Parameter
额定功率	Rated Power	1200W
输入电压	Input Voltage	90-305V AC
频率范围	Frequency	50 / 60Hz
功率因数	Power Factor	> 0.95
光源类型	Light Source Type	LED
光源品牌	Light Source Brand	CREE
色温	Color Temperature	3000K / 4000K / 5700K / RGB
控制方式	Control Mode	ON-OFF / DMX512 / SPI
电源品牌	Power Supply Brand	明伟
工作环境温度	Temperature of Working Condition	-25°C~50°C
使用寿命	Life	>30000H
防护等级	Protection Grade	IP 65



L0003 金帆

专利设计 DESIGN PATENT



产品尺寸 Product Size

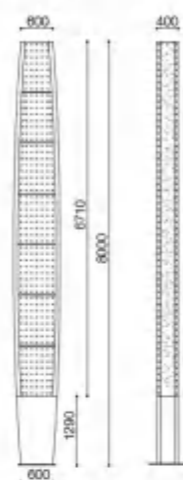

适用场合

主要应用于广场、公园、步行街等。

The Application of Occasions

Suitable places: Square, Park, Pedestrian, etc.

产品特点说明

1. 灯体主体采用金属龙骨架，内外热镀锌，表面喷塑，抗风等级达到12级风力。
2. 侧面1透光面采用乳白色PC板透光，光源采用LED数码管，竖向排列布置，采用控制器控制七彩变色效果。
3. 侧面2采用不锈钢拉丝面板包裹，光源采用LED点光源矩阵布置，采用控制器控制七彩变色效果，并与LED数码管同步控制。
4. 焊接工艺：高强度氩弧焊整体焊接。
5. 打磨工艺：先粗砂打磨再细砂打磨最后喷塑。
6. 景观灯整体比例恰当，工艺完美，造型美观大方，质感强烈。

Product Description

1. Metal dragon light framework, inside and outside hot galvanized, powder coated, wind loading resistance up to 12 level.
2. Side 1: using opal PC diffuser, adopts LED digital light source on vertical arrangement, cooperate with 7 color change control.
3. Side 2: parceled with stainless steel wire-drawn curved plate, adopts LED point light by matrix arrangement, effected with seven color changing and LED digital tube synchronous control.
4. Welding process: High strength argon arc welding.
5. Grinding process: Powder coated after sand grinding.
6. Perfect percentage of the whole lamp, strong simple sense.



CE RoHS CCC IP65

技术参数 Specification

类别	Product Code	参数 Parameter
额定功率	Rated Power	1100W
输入电压	Input Voltage	90-305V AC
频率范围	Frequency	50 / 60Hz
功率因数	Power Factor	> 0.95
光源类型	Light Source Type	LED
光源品牌	Light Source Brand	CREE
色温	Color Temperature	3000K / 4000K / 5700K / RGB
控制方式	Control Mode	ON-OFF / DMX512 / SPI
电源品牌	Power Supply Brand	明伟
工作环境温度	Temperature of Working Condition	-25°C-50°C
使用寿命	Life	>30000H
防护等级	Protection Grade	IP 65

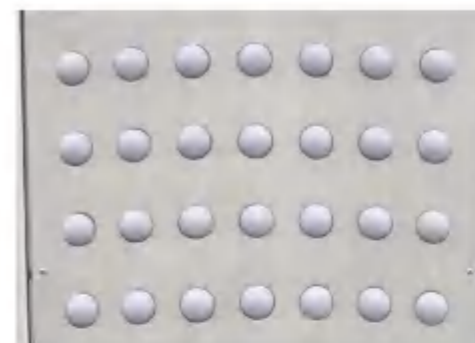

L0006 苗姑娘

专利设计 DESIGN PATENT



产品尺寸 Product Size

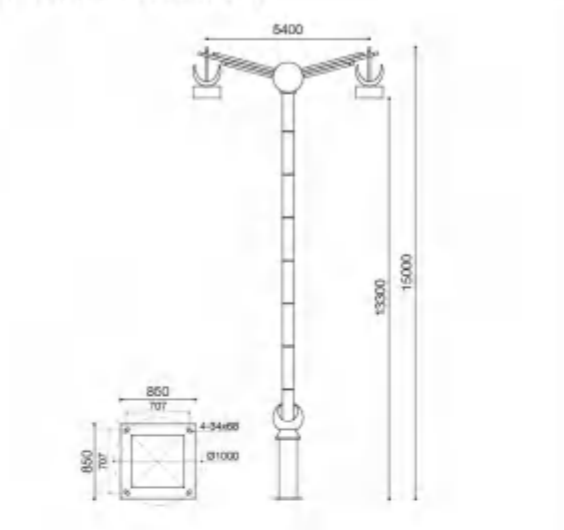

适用场合

主要应用于广场、公园、步行街等。

The Application of Occasions

Suitable places: Square, Park, Pedestrian, etc.

产品特点说明

1. 主体采用钢结构龙骨架，内外热镀锌，表面喷漆，抗风等级达到12级。
2. 整体造型融入少数民族文化图案，符合当地习俗。
3. 图案及造型采用激光切割。
4. 整体光源均采用LED节能光源，满足装饰及照明功能。
5. 焊接工艺：高强度氩弧焊整体焊接。
6. 表面工艺：粗磨-热镀锌-粗磨-细磨-精磨-喷漆。
7. 景观灯整体比例恰当，工艺完美，造型美观大方，质感强烈。

Product Description

1. The main steel keel frame, inside and outside the hot galvanized, plastic sprayed surface, the wind reached level 12.
2. The overall shape into the national cultural patterns, in line with local customs.
3. Patterns and shapes using laser cutting.
4. The overall light source using LED energy-saving light source, to meet the decoration and lighting.
5. Welding process: high strength argon arc welding.
6. Surface technology: coarse grinding - hot dip galvanized - - coarse grinding fine grinding grinding - spray.
7. The overall proportion of landscape lamps appropriate, perfect technology, beautiful appearance generous, strong texture.

颜色选择 Color Selection

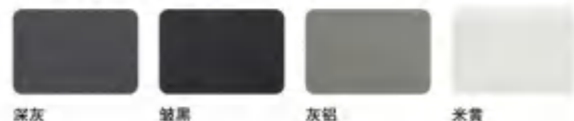

技术参数 Specification

类别	Product Code	参数 Parameter
额定功率	Rated Power	1700W LED
输入电压	Input Voltage	90-305V AC
频率范围	Frequency	50 / 60Hz
功率因数	Power Factor	> 0.95
光源类型	Light Source Type	LED
光源品牌	Light Source Brand	CREE
色温	Color Temperature	3000K / 4000K / 5700K / RGB
控制方式	Control Mode	ON-OFF / DMX512 / SPI
电源品牌	Power Supply Brand	明伟
工作环境温度	Temperature of Working Condition	-25°C-50°C
使用寿命	Life	>30000H
防护等级	Protection Grade	IP 65

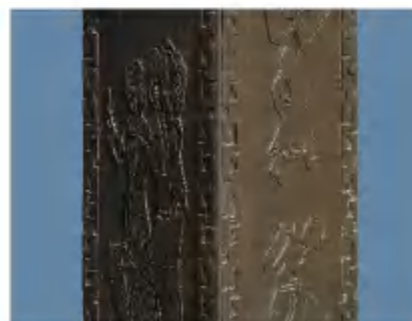

L0007 苗先生

专利设计 DESIGN PATENT



产品尺寸 Product Size

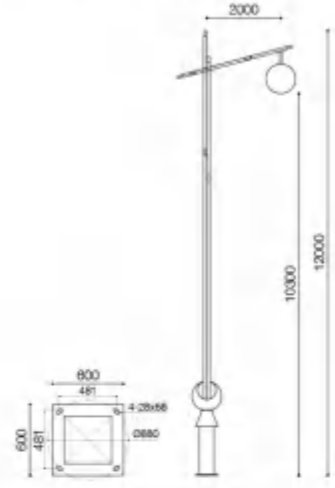

适用场合

主要应用于广场、公园、步行街等。

The Application of Occasions

Suitable places: Square, Park, Pedestrian, etc.

产品特点说明

1. 主体采用钢结构龙骨架，内外热镀锌，表面喷漆，抗风等级达到12级。
2. 整体造型融入少数民族文化图案，符合当地习俗。
3. 图案及造型采用激光切割。
4. 整体光源均采用LED节能光源，满足装饰及照明功能。
5. 焊接工艺：高强度氩弧焊整体焊接。
6. 表面工艺：粗磨-热镀锌-粗磨-细磨-精磨-喷漆。
7. 景观灯整体比例恰当，工艺完美，造型美观大方，质感强烈。

Product Description

1. The main steel keel frame, inside and outside the hot galvanized, plastic sprayed surface, the wind reached level 12.
2. The overall shape into the national cultural patterns, in line with local customs.
3. Patterns and shapes using laser cutting.
4. The overall light source using LED energy-saving light source, to meet the decoration and lighting.
5. Welding process: high strength argon arc welding.
6. Surface technology: coarse grinding - hot dip galvanized - - coarse grinding fine grinding grinding - spray.
7. The overall proportion of landscape lamps appropriate, perfect technology, beautiful appearance generous, strong texture.

颜色选择 Color Selection

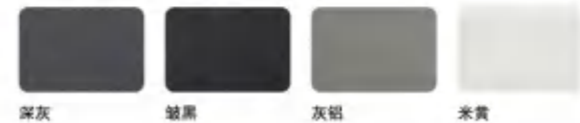

技术参数 Specification

类别	Product Code	参数 Parameter
额定功率	Rated Power	380W
输入电压	Input Voltage	90-305V AC
频率范围	Frequency	50 / 60Hz
功率因数	Power Factor	> 0.95
光源类型	Light Source Type	LED
光源品牌	Light Source Brand	CREE
色温	Color Temperature	3000K / 4000K / 5700K / RGB
控制方式	Control Mode	ON-OFF / DMX512 / SPI
电源品牌	Power Supply Brand	明伟
工作环境温度	Temperature of Working Condition	-25°C-50°C
使用寿命	Life	>30000H
防护等级	Protection Grade	IP 65

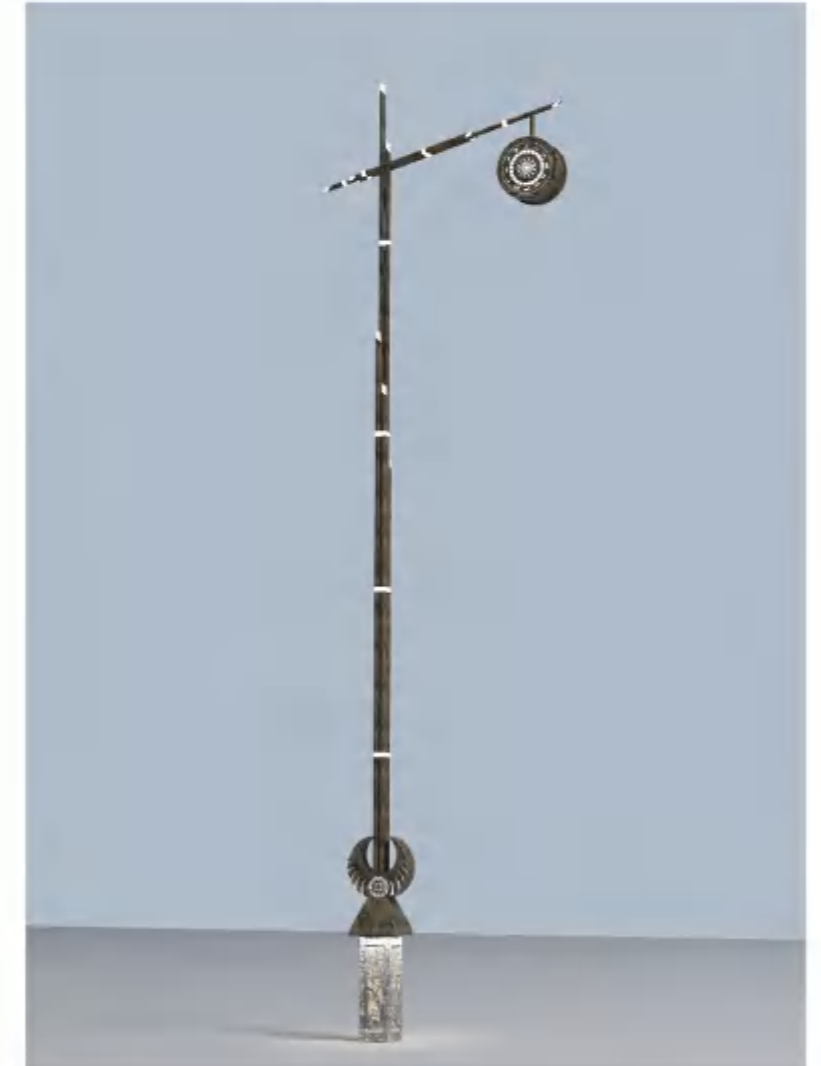
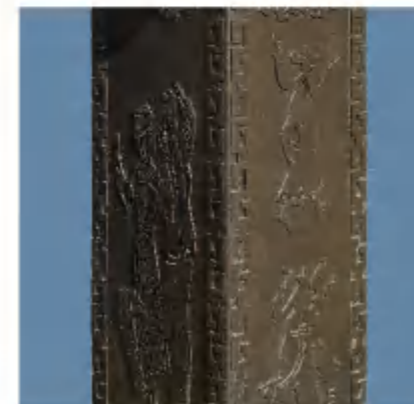

BT-BF12T BTS

联机 脱机主控 卫星同步
Online Offline Master Control Satellite Synchronization

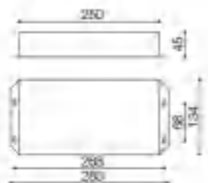

系统特点

1. 带载量最大支持15万像素点，极大满足客户项目的需求。
2. 通过接收BTS基站信号可实现多台控制器的无线联动同步，满足客户在多层楼宇间无法连线的情况下实现多台控制器同步的需求。
3. 系统支持自动、定时、节日预设效果播放。
4. 控制器带按键和外配遥控器，可实现节目片段选择、整体亮度调整、白平衡调整、播放速度调整等。
5. 支持脱机一键固定、清除分控ID编号，方便现场运用。
6. 支持DMX512AP-N/NB、UCS512、TM512、WS2821等驱动芯片脱机写地址。
7. 支持交换机并联方案：减少系统级联链长度提高稳定性。
8. 支持双路备份，一个控制器坏或者网线断显示不受影响。
9. 三色独立亮度控制，使精确调整白平衡更加简单有效。
10. 支持四色灯具：节能环保，色彩纯正。
11. 采用以太网接口和UDP网络协议传输稳定，最大传输距离100米。
12. LCD显示模块及时显示控制器参数及状态。
13. SD卡存储，控制器最大可支持32G，最多可预设99个节目文件。
14. 支持多台脱机主控远程在线下载、更新脱机节目。
15. 内置动画测试程序，方便客户在项目调试和应用。
16. 可支持不同类型灯具以及不同协议灯具混用，兼容性强。

System Characteristics

1. With a maximum load capacity of 15 million pixels, great to meet customer demand for the project.
2. By receiving BTS base station signals can be achieved more than one controller wireless synchronization to meet the customers' requirements of multiple controllers synchronization needs when customer can not be connected between buildings.
3. The system supports automatic, regular, holiday preset effect playback.
4. Controller includes buttons and external remote control, can achieve program fragment selection, the overall brightness adjustment, white balance adjustment, playback speed adjustment, etc.
5. Support off-line a key fixed, clear sub-control ID number, to facilitate the use of the site.
6. Support DMX512AP-N / NB, UCS512, TM512, WS2821 and other drive-chip offline write address.
7. Support switch parallel program: to reduce the length of the system cascade chain to improve stability.
8. Support dual backup, a bad controller or network line will not affect display.
9. Three-color independent brightness control, so that accurate adjustment of white balance is more simple and effective.
10. Support four-color lamps: energy saving, pure color.
11. Using Ethernet interface and UDP network protocol transmission stability, the maximum transmission distance of 100 meters.
12. LCD display module timely display controller parameters and status.
13. SD card storage, the controller can support up to 32G, up to 99 preset program files.
14. Support remote online download, update the offline program.
15. Built-in animation test program, Convenient for customers in the project debugging and application.
16. Can support different types of lamps and different lighting fixture agreement, compatibility.

控制器基本参数表 Controller Basic Parameter Table

额定电压	Rated Voltage	AC 100V~240V
额定功率	Rated Power	15W
长度	Length	263mm
宽度	Width	134mm
高度	Height	45mm
固定孔间距	Fixed Hole Spacing	268mm; 68 mm
天线尺寸	Antenna Size	30x30x26mm
天线信号线	Antenna Signal Line	标配长度3m Standard length 3m
标配附件	Standard Accessories	遥控器x1 / SD卡x1 / AC电源线x1 Remote controller x 1 / SD card x 1 / AC power cord x 1

控制器安装应用 The Controller Installation and Application

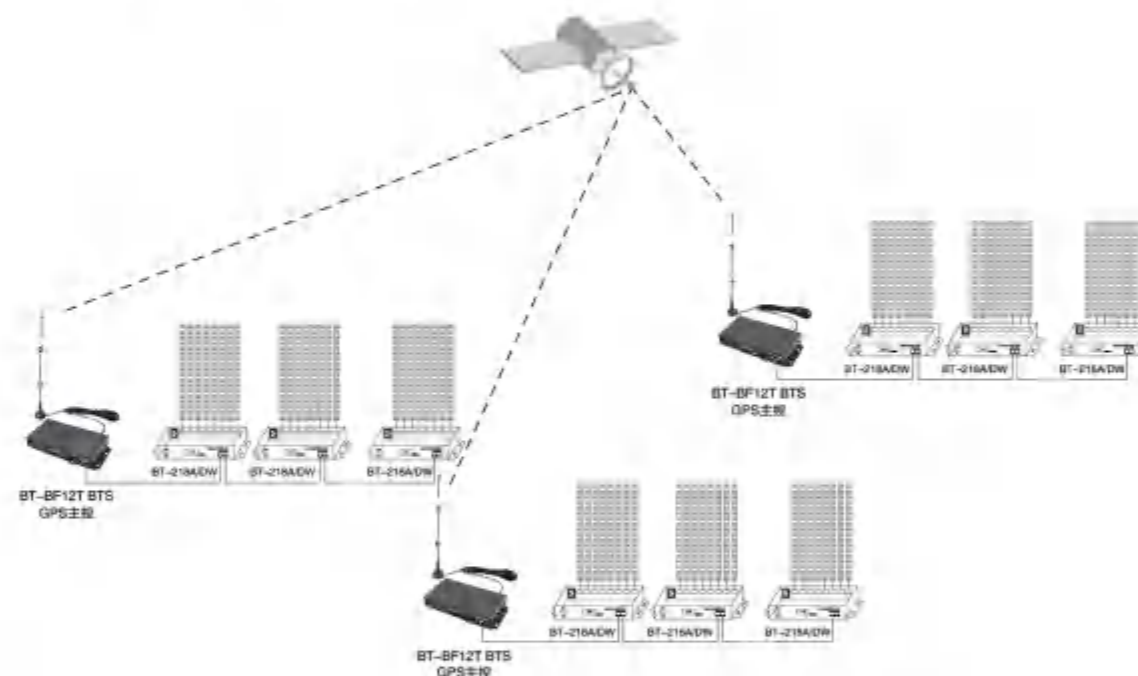

注意事项

1. 电脑、控制器、网络交换机之间，用超五类网线连接，最大距离100米，超过100米，需采用光纤连接。
2. 控制器与控制器之间采用超五类网线级联，如果10米以内，可以采用直通线序，超过10米建议采用交叉线，线序如下：
568A~568A：白绿 | 绿 | 白橙 | 蓝 | 白蓝 | 橙 | 白棕 | 棕
568A~568B：白橙 | 橙 | 白绿 | 蓝 | 白蓝 | 绿 | 白棕 | 棕
3. 分控到首灯之间推荐使用超五类网线，DMX512最大距离100米，SPI最大距离30米，超过需加DMX512中继器或SPI差分器。
4. 分控每个端口可带DMX512灯具512个通道，可带SPI灯具512个点；DMX512灯具回路每32个节点需要增加一个中继器，SPI灯具回路正常无需差分器。

Matters Needing Attention

1. Computers, controllers, network switches, with more than five types of cable connections, the maximum distance of 100 meters, more than 100 meters, the need for optical fiber connection.
2. Between the controller and the controller to use more than five kinds of network cable cascade, if within 10 meters, you can use the straight line sequence, more than 10 meters recommend the use of cross line, the line is as follows:
568A-568A: White and Green | Green | White and Orange | Blue | White and Blue | Orange | White and Brown | Brown
568A-568B: White and Orange | Orange | White and Green | Blue | White and Blue | Green | White and Brown | Brown
3. Points to the first lamp recommended to use more than five types of cable, DMX512 maximum distance of 100 meters, SPI maximum distance of 30 meters, more than the need to add DMX512 repeater or SPI differential.
4. Points each port can be controlled with DMX512 lights 512 channels, with SPI lamps can be 512 points; DMX512 lamp circuit every 32 nodes need to add a repeater, SPI lamp circuit without the need for a differential.

BT-BF12B

联机 脱机主控

Online Offline Master Control

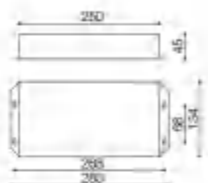

系统特点

1. 带载量最大支持15万像素点，极大满足客户项目的需求。
2. 系统支持自动、定时、节日预设效果播放。
3. 控制器带按键和外配遥控器，可实现节目片段选择、整体亮度调整、白平衡调整、播放速度调整等。
4. 支持脱机一键固定、清除分控ID编号，方便现场运用。
5. 支持交换机并联方案：减少系统级联链长度提高稳定性。
6. 支持双路备份，一个控制器坏或者网线断显示不受影响。
7. 三基色独立亮度控制，使精确调整白平衡更加简单有效。
8. 支持四色灯具：节能环保，色彩纯正。
9. 采用以太网接口和UDP网络协议传输稳定，最大传输距离100米。
10. LCD显示模块及时显示控制器参数及状态。
11. SD卡存储，控制器最大可支持32G，最多可预设99个节目文件。
12. 支持多台脱机主控远程在线下载、更新脱机节目。
13. 内置动画测试程序，方便客户在项目调试和应用。
14. 可支持不同类型灯具以及不同协议灯具混用，兼容性强。

System Characteristics

1. With a maximum load capacity of 15 million pixels, greatly meet customer demand.
2. The system supports automatic, regular, holiday preset effect playback.
3. Controller with buttons and external with remote control, can achieve program fragment selection, the overall brightness adjustment, white balance adjustment, playback speed adjustment, etc.
4. Support offline with a key fixed, clear sub-control ID number, easy to use on-site.
5. Support switch parallel program: reduce the length of the system cascade chain to improve stability.
6. Support two-way backup, a bad controller or network break display is not affected.
7. Three primary colors independent brightness control, precise adjustment of white balance is more simple and effective.
8. Support four-color lamps: energy-saving environmental protection, pure color.
9. Using Ethernet interface and UDP network protocol transmission stability, the maximum transmission distance of 100 meters.
10. LCD display module timely display controller parameters and status.
11. SD card storage, the controller can support up to 32G, up to 99 preset program files.
12. Support multiple offline master remote online download, update the offline program.
13. Built-in animation test program to facilitate debugging and application in the project.
14. Support different types of lamps and lanterns with different protocol mix, compatibility.

扩展性

1. 可安装目前所有Windows操作系统及支持各国语言。
2. 播放软件留有充足接口以便和其他国际通用协议兼容，并支持客户个性化设计需求。
3. 支持与MR控制系统中多功能转换器等控制器结合，以实现特殊项目应用需求。

Extensibility

1. Can be installed at present all Windows operating system and support any country language.
2. Playback software has sufficient interface to be compatible with other international protocols and supports customized design requirements.
3. Can support MR control system that multi-function converter and other controller combination, in order to achieve special project application requirements.

控制器基本参数表 Controller Basic Parameter Table

额定电压	Rated Voltage	AC 100V~240V
额定功率	Rated Power	15W
长度	Length	283mm
宽度	Width	134mm
高度	Height	45mm
固定孔间距	Fixed Hole Spacing	268mm; 68mm
标配附件	Standard Accessories	遥控器x1 / SD卡x1 / 读卡器x1 / AC电源线x1 / Remote control x 1 / SD card x 1 / Card reader x 1 / AC power cord x 1

控制器安装应用

1. 脱机模式

BT-BF12B与分控器连接，如下图所示：

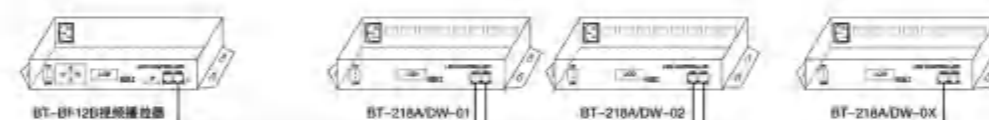

The Controller Installation and Application

1. Offline mode

The BT-BF12B is connected to the offline master as shown below:

2. 联/脱机一体模式

与电脑、分控器连接（联机信号优先。无联机信号时自动切换脱机信号），如下图所示：



2. Connected / offline integrated model

Connect the computer, offline master (online signal priority. No online signal automatically switch off-line signal), as shown below.

注意事项

1. 电脑、控制器、网络交换机之间，用超五类网线连接，最大距离100米，超过100米，需采用光纤连接。
2. 控制器与控制器之间采用超五类网线级联，如果10米以内，可以采用直通线序，超过10米建议采用交叉线，线序如下：
568A~568A：白绿|绿|白橙|蓝|白蓝|橙|白棕|棕
568A~568B：白橙|橙|白绿|蓝|白蓝|绿|白棕|棕
3. 分控到首灯之间推荐使用超五类网线，DMX512最大距离100米，SPI最大距离30米，超过需加DMX512中继器或SPI差分器。
4. 分控每个端口可带DMX512灯具512个通道，可带SPI灯具512个点；DMX512灯具回路每32个节点需要增加一个中继器，SPI灯具回路正常无需差分器。

Matters Needing Attention

1. Computers, controllers, network switches, with more than five types of cable connections, the maximum distance of 100 meters, more than 100 meters, the need for optical fiber connection.
2. Between the controller and the controller to use more than five kinds of network cable cascade, if within 10 meters, you can use the straight line sequence, more than 10 meters recommend the use of cross line, the line is as follows:
568A-568A: White and Green | Green | White and Orange | Blue | White and Blue | Orange | White and Brown | Brown
568A-568B: White and Orange | Orange | White and Green | Blue | White and Blue | Green | White and Brown | Brown
3. Points to the first lamp recommended to use more than five types of cable, DMX512 maximum distance of 100 meters, SPI maximum distance of 30 meters, more than the need to add DMX512 repeater or SPI differential.
4. Points each port can be controlled with DMX512 lights 512 channels, with SPI lamps can be 512 points; DMX512 lamp circuit every 32 nodes need to add a repeater, SPI lamp circuit without the need for a differential.

BT-218A

SPI分控
SPI Control

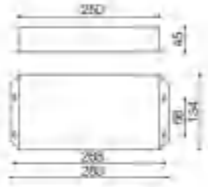

系统特点

1. 32-65536级灰度控制，可真实还原图像色彩和细节。
2. 三基色独立亮度控制，精确调整白平衡更加简单有效。
3. 精准色马校正算法，符合人体视觉感光特性，色彩变化细腻流畅，使视频动画效果完美体现。
4. 最大支持120帧帧率以保证画面高清显示和3D显示需求。
5. 采用以太网接口和UDP网络协议传输稳定，最大传输距离100米。
6. LCD显示模块及时显示控制器参数及状态。
7. 控制器输出兼容TTL电平信号和差分信号双模式。
8. 多种芯片控制集于一体，通过软件设置更改控制芯片类型、时钟频率、占空比、灰度级等参数。
9. 双网络接口，可以实现控制器间级联，控制器自动检测，软件直观显示连接状态。
10. 8端口输出，单口带载点数不受限制，由客户根据芯片特性自行测试。
11. 支持双路备份，一个控制器坏或者网线断显示不受影响。
12. 千/百兆自适应或者强制千兆可设，保证大点数的项目更稳定。

System Characteristics

1. 32-65536 Level gray-scale control, can be true to restore the image color and detail.
2. Three primary colors independent brightness control, precise adjustment of white balance is more simple and effective.
3. Precision gamma correction algorithm, more in line with the human visual sensory characteristics, display color more fully, rich! So that the designer's animation or video effects perfect embodiment.
4. Maximum support 120 frame frequency to support that the screen high-definition display and 3D display requirements.
5. Using Ethernet interface and UDP network protocol transmission stability, the maximum transmission distance of 100 meters.
6. LCD display module timely display controller parameters and status.
7. The controller output is compatible with TTL level signal and differential signal dual mode.
8. A variety of chip control set in one, through the software settings to change the control chip type, clock frequency, duty cycle, grayscale and other parameters.
9. Dual network interface, can be cascaded between the controller, the controller automatically detects the software to visually display the connection status.
10. 8-port output, single-port load with unlimited points, customers can do test by self according to the chip characteristics.
11. Support two-way backup, a bad controller or network break display is not affected.
12. 1000 / 100M adaptive or mandatory Fast can be set to ensure that the larger points of the project more stable.

控制器基本参数表 Controller Basic Parameter Table

额定电压	Rated Voltage	AC 100V-240V
额定功率	Rated Power	15W
长度	Length	283mm
宽度	Width	134mm
高度	Height	45mm
固定孔间距	Fixed Hole Spacing	268mm; 68 mm
标配附件	Standard Accessories	AC电源线 ≥ 1 AC power cable ≥ 1

扩展性

1. 可同、异步播放多种格式的视频和图片文件内容。
2. 可安装目前所有Windows操作系统及支持各国语言。
3. 播放软件留有充足接口以便和其他国际通用协议兼容，并支持客户个性化设计需求。
4. 支持市面上所有主流串行数据接口的LED驱动芯片，如MBI6020、MBI6021、MBI6024、MBI6030、LPD6803、LPD8806、LPD1886、TM1803、TM1804、TM1829、TM1812、TLS3001、TLS3008、MY9221、MY9231、WS2801、WS2811、SM16716、BS0815、BS0901、BS0902、UCS8903、UCS3903、TI5971、GW6201、GW6202、GW62052等。

Extensibility

1. Can be the same, asynchronous playback of multiple formats of video and image file content.
2. Can be installed at present all Windows operating system and support any country language.
3. Playback software has sufficient interface to be compatible with other international protocols and supports customized design requirements.
4. Support all the mainstream serial data interface of LED driver chip on the market, such as MBI6020, MBI6021, MBI6024, MBI6030, LPD6803, LPD8806, LPD1886, TM1803, TM1804, TM1829, TM1812, TLS3001, TLS3008, MY9221, MY9231, WS2801, WS2811, SM16716, BS0815, BS0901, BS0902, UCS8903, UCS3903, TI5971, GW6201, GW6202, GW62052, etc.

控制器安装应用

1. 联机模式 (与上位机电脑连接)

BT-218A控制器与计算机的以太网端口连接，如下图所示：

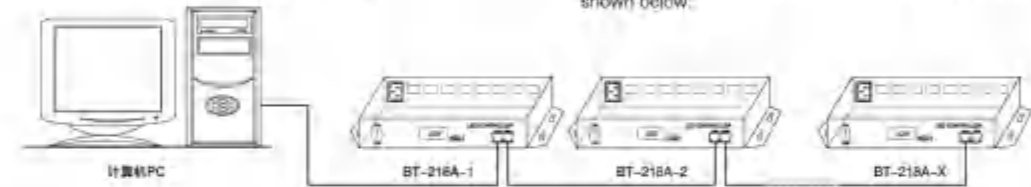

2. 脱机模式

BT-218A与脱机主控连接，如下图所示：

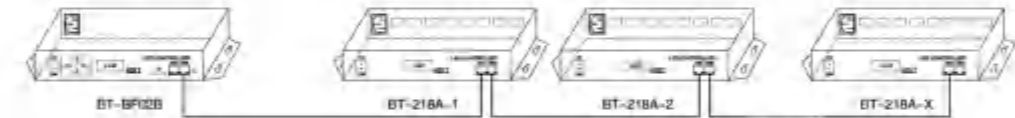

3. 同、异步一体模式

与电脑、脱机主控连接 (联机信号优先。无联机信号时自动切换脱机信号)，如下图所示：



The Controller Installation and Application

1. On-line mode (connected to host computer)

The BT-218A controller is connected to the computer's Ethernet port as shown below:

2. Offline mode

The BT-218A is connected to the offline master as shown below:

3. Connected / offline integrated model

Connect the computer (online signal priority. No online signal automatically switch off-line signal), as shown below:

注意事项

1. 电脑、控制器、网络交换机之间，用超五类网线连接，最大距离100米，超过100米，需采用光纤连接。
2. 控制器与控制器之间采用超五类网线级联。如果10米以内，可以采用直通线序，超过10米建议采用交叉线，线序如下：
568A-568A：白绿 | 绿 | 白橙 | 蓝 | 白蓝 | 橙 | 白棕 | 棕
568A-568B：白橙 | 橙 | 白绿 | 蓝 | 白蓝 | 绿 | 白棕 | 棕
3. 分控到首灯之间推荐使用超五类网线，DMX512最大距离100米，SPI最大距离30米，超过需加DMX512中继器或SPI差分器。
4. 分控每个端口可带DMX512灯具512个通道，可带SPI灯具512个点；DMX512灯具回路每32个节点需要增加一个中继器，SPI灯具回路正常无需差分器。

Matters Needing Attention

1. Computers, controllers, network switches, with more than five types of cable connections, the maximum distance of 100 meters, more than 100 meters, the need for optical fiber connection.
2. Between the controller and the controller to use more than five kinds of network cable cascade, if within 10 meters, you can use the straight line sequence, more than 10 meters recommend the use of cross line, the line is as follows:
568A-568A: White and Green | Green | White and Orange | Blue | White and Blue | Orange | White and Brown | Brown
568A-568B: White and Orange | Orange | White and Green | Blue | White and Blue | Green | White and Brown | Brown
3. Points to the first lamp recommended to use more than five types of cable, DMX512 maximum distance of 100 meters, SPI maximum distance of 30 meters, more than the need to add DMX512 repeater or SPI differential.
4. Points each port can be controlled with DMX512 lights 512 channels, with SPI lamps can be 512 points; DMX512 lamp circuit every 32 nodes need to add a repeater, SPI lamp circuit without the need for a differential.

BT-218DW

512分控
512 Control

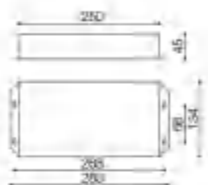

系统特点

1. BT-218DW支持标准USITT DMX512/1990通用协议和扩展DMX512协议。
2. 控制器信号输出ADRI/PO端可实现DMX512通道自动编址, 支持DMX512AP-N/NB, UCS512, MY7221, WS2821等驱动芯片。
3. BT-218DW控制器编址信号输出兼容输出差分信号, 提高了编址信号的传输距离, 利于项目应用中编址线长距离的传输及有效编址。
4. 三色独立亮度控制, 使精确调整白平衡更加简单有效。
5. 精准伽马矫正算法, 更加符合人体视觉感光特性, 显示色彩更细腻丰富。
6. 最大支持120帧频率以保证画面高清显示和3D显示需求。
7. 采用以太网接口和UDP网络协议传输稳定, 最大传输距离100米。
8. LCD显示模块及时显示控制器参数及状态。
9. 双网络接口, 可以实现控制器间级联; 控制器自动检测, 软件直观显示连接状态。
10. 8端口输出, 单口输出标准512通道, 扩展协议带载点数由客户根据芯片特性自行测试。
11. 支持双路备份, 一个控制器坏或者网线断显示不受影响。
12. 千/百米自适应或者强制百米可设, 保证大点数的项目更稳定。

控制器基本参数表 Controller Basic Parameter Table

额定电压	Rated Voltage	AC 100V-240V
额定功率	Rated Power	15W
长度	Length	263mm
宽度	Width	134mm
高度	Height	45mm
固定孔间距	Fixed Hole Spacing	265mm; 68mm
标配附件	Standard Accessories	AC电源线 x 1 AC power cable x 1

System Characteristics

1. The BT-218DW supports the standard USITT DMX512 / 1990 universal protocol and the extended DMX512 protocol.
2. Controller signal output ADRI / PO-side DMX512 channel can be automatically addressed to support DMX512AP-N / NB, UCS512, MY7221, WS2821 and other driver chips.
3. BT-218DW controller addressing signal output compatible with the output differential signal to improve the address signal transmission distance, which will help the project application of the address line transmission and effective long-range addressing.
4. Three primary colors independent brightness control, precise adjustment of white balance is more simple and effective.
5. Precision gamma correction algorithm, more in line with the human visual sensory characteristics, display color more fully, rich! So that the designer animation or video effects perfect embodiment.
6. Maximum support 120 frame frequency to support that the screen high-definition display and 3D display requirements.
7. Using Ethernet interface and UDP network protocol transmission stability, the maximum transmission distance of 100 meters.
8. LCD display module timely display controller parameters and status.
9. Dual network interface, can be cascaded between the controller, the controller automatically detects the software to visually display the connection status.
10. 8-port output, single-port load with unlimited points, customers can do test by self according to the chip characteristics.
11. Support two-way backup, a bad controller or network break display is not affected.
12. 1000 / 100M adaptive or mandatory Fast can be set to ensure that the larger points of the project more stable.

扩展性

1. 可同、异步播放多种格式的视频和图片文件内容。
2. 可安装目前所有Windows操作系统及支持各国语言。
3. 播放软件留有充足接口以便和其他国际通用协议兼容, 并支持客户个性化设计需求。
4. 支持DMX512AP-N, DMX512AP-NB, UCS512, MY7221, WS2821, SM512-12等驱动芯片。

控制器安装应用

1. 联机模式 (与上位机电脑连接)
BT-218DW控制器与计算机的以太网端口连接, 如下图所示:

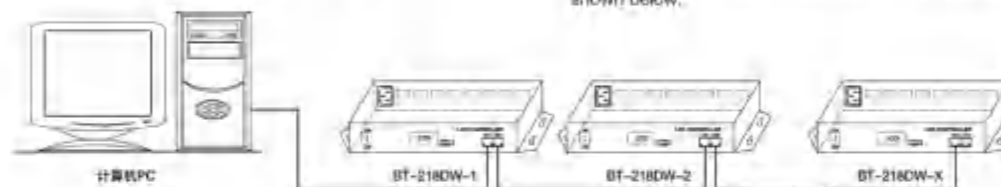

2. 脱机模式
BT-218DW与脱机主控连接, 如下图所示:

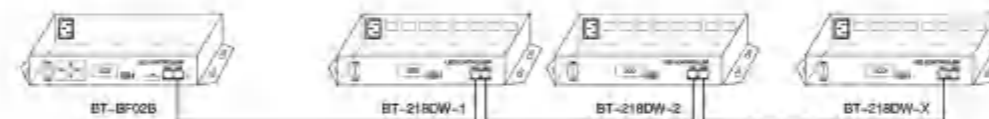

3. 同、异步一体模式
与电脑、脱机主控连接 (联机信号优先, 无联机信号时自动切换脱机信号), 如下图所示:



注意事项

1. 电脑、控制器、网络交换机之间, 用超五类网线连接, 最大距离100米, 超过100米, 需采用光纤连接。
2. 控制器与控制器之间采用超五类网线级联, 如果10米以内, 可以采用直通线序, 超过10米建议采用交叉线, 线序如下:
568A-568A: 白绿 | 绿 | 白橙 | 蓝 | 白蓝 | 橙 | 白棕 | 棕
568A-568B: 白橙 | 橙 | 白绿 | 蓝 | 白蓝 | 绿 | 白棕 | 棕
3. 分控到首灯之间推荐使用超五类网线, DMX512最大距离100米, SPI最大距离30米, 超过需加DMX512中继器或SPI差分器。
4. 分控每个端口可带DMX512灯具512个通道, 可带SPI灯具512个点; DMX512灯具回路每32个节点需要增加一个中继器, SPI灯具回路正常无需差分器。

Extensibility

1. Can be the same, asynchronous playback of multiple formats of video and image file content.
2. Can be installed at present all Windows operating system and support any country language.
3. Playback software has sufficient interface to be compatible with other international protocols and supports customized design requirements.
4. Support DMX512AP-N, DMX512AP-NB, UCS512, MY7221, WS2821, SM512-12 and other driver chips

The Controller Installation and Application

1. On-line mode (connected to host computer)
The BT-218DW controller is connected to the computer's Ethernet port as shown below:

2. Offline mode
The BT-218DW is connected to the offline master as shown below:

3. Connected / offline integrated model
Connect the computer (online signal priority, No online signal automatically switch off-line signal), as shown below:

Matters Needing Attention

1. Computers, controllers, network switches, with more than five types of cable connections, the maximum distance of 100 meters, more than 100 meters, the need for optical fiber connection
2. Between the controller and the controller to use more than five kinds of network cable cascade, if within 10 meters, you can use the straight line sequence, more than 10 meters recommend the use of cross line, the line is as follows:
568A-568A: White and Green | Green | White and Orange | Blue | White and Blue | Orange | White and Brown | Brown
568A-568B: White and Orange | Orange | White and Green | Blue | White and Blue | Green | White and Brown | Brown
3. Points to the first lamp recommended to use more than five types of cable, DMX512 maximum distance of 100 meters, SPI maximum distance of 30 meters, more than the need to add DMX512 repeater or SPI differential.
4. Points each port can be controlled with DMX512 lights 512 channels, with SPI lamps can be 512 points; DMX512 lamp circuit every 32 nodes need to add a repeater, SPI lamp circuit without the need for a differential.

BT-318A

SPI单机主控
SPI Single Main Control

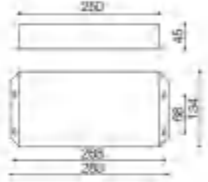

系统特点

- 32-65536级灰度控制，可真实还原图像色彩和细节。
- 系统支持自动，定时，节日预设效果播放。
- 精准伽马校正算法，更加符合人体视觉感光特性，显示色彩更充分，丰富，使设计者动画或视频效果完美体现。
- 最大支持120帧频率以保证画面高清显示和3D显示需求。
- 控制器带按键和外配遥控器，可实现节目片段选择、整体亮度调整、白平衡调整、播放速度调整等。
- LCD显示模块及时显示控制器参数及状态。
- 控制器输出兼容TTL电平信号和差分信号双模式。
- 多种芯片控制集于一体，通过软件设置更改控制芯片类型、时钟频率、占空比、灰度级等参数。
- 支持四色灯具：节能环保，色彩纯正。
- 8端口输出，单口带载点数不受限制，由客户根据芯片特性自行测试。
- SD卡存储，控制器最大可支持32G，最多可预设99个节目文件。
- 支持远程在线下载，更新脱机节目。
- 内置动画测试程序，方便客户在项目调试和应用。

System Characteristics

- 32-65536 Level gray-scale control, can be true to restore the image color and detail.
- The system supports automatic, regular, holiday preset effect playback.
- Precision gamma correction algorithm, more in line with the human visual sensory characteristics, display color more fully, rich. So that the designer animation or video effects perfect embodiment.
- Maximum support 120 frame frequency to support that the screen high-definition display and 3D display requirements.
- Controller includes buttons and external remote control, can achieve program fragment selection, the overall brightness adjustment, white balance adjustment, playback speed adjustment, etc.
- LCD display module timely display controller parameters and status.
- The controller output is compatible with TTL level signals and differential signals in dual mode.
- A variety of chip control set in one, through the software settings to change the control chip type, clock frequency, duty cycle, grayscale and other parameters.
- Support four-color lamps: energy saving, pure color.
- 8-port output, single-port load with unlimited points, according to the chip characteristics customers can do test by self.
- SD card storage, the controller can support up to 32G, up to 99 preset program files.
- Support remote online download, update the offline program.
- Built-in animation test program, convenient for customers in the project debugging and application.

扩展性

- 可安装目前所有Windows操作系统及支持各国语言。
- 播放软件留有充足接口以便和其他国际通用协议兼容，并支持客户个性化设计需求。

Extensibility

- Can be installed at present all Windows operating system and support any country language.
- Playback software has sufficient interface to be compatible with other international protocols and supports customized design requirements.

控制器基本参数表 Controller Basic Parameter Table

额定电压	Rated Voltage	AC 100V~240V
额定功率	Rated Power	15W
长度	Length	263mm
宽度	Width	134mm
高度	Height	45mm
固定孔间距	Fixed Hole Spacing	268mm; 68mm
标配附件	Standard Accessories	遥控器x1 / SD卡x1 / 读卡器x1 / AC电源线x1 Remote control x 1 / SD card x 1 / Card reader x 1 / AC power cord x 1

控制器安装应用

- 脱机模式
脱机模式直接带载灯具，如下图：

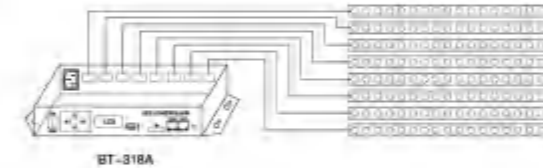

The Controller Installation and Application

- Offline mode
Offline mode directly loaded lamps, as shown below:

- 取/脱机一体模式
与电脑连接（联机信号优先。无联机信号时自动切换脱机信号），如下图所示：

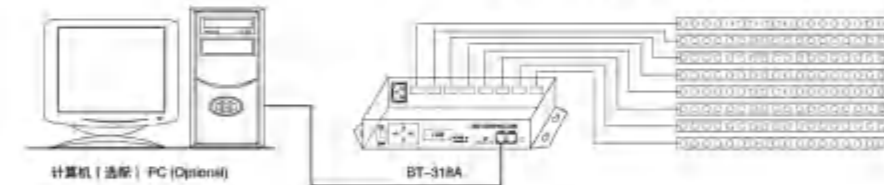

- Connected / offline integrated model
Connect the computer (online signal priority. No online signal automatically switch off-line signal), as shown below:

注意事项

- 电脑、控制器、网络交换机之间，用超五类网线连接，最大距离100米，超过100米，需采用光纤连接。
- 控制器与控制器之间采用超五类网线级联。如果10米以内，可以采用直通线序，超过10米建议采用交叉线。线序如下：
568A-568A：白绿 | 绿 | 白橙 | 蓝 | 白蓝 | 橙 | 白棕 | 棕
568A-568B：白橙 | 橙 | 白绿 | 蓝 | 白蓝 | 绿 | 白棕 | 棕
- 分控到首灯之间推荐使用超五类网线，DMX512最大距离100米，SPI最大距离30米，超过需加DMX512中继器或SPI差分器。
- 分控每个端口可带DMX512灯具512个通道，可带SPI灯具512个点；DMX512灯具回路每32个节点需要增加一个中继器，SPI灯具回路正常无需差分器。

Matters Needing Attention

- Computers, controllers, network switches, with more than five types of cable connections, the maximum distance of 100 meters, more than 100 meters, the need for optical fiber connection.
- Between the controller and the controller to use more than five kinds of network cable cascade, if within 10 meters, you can use the straight line sequence, more than 10 meters recommend the use of cross line, the line is as follows:
568A-568A: White and Green | Green | White and Orange | Blue | White and Blue | Orange | White and Brown | Brown
568A-568B: White and Orange | Orange | White and Green | Blue | White and Blue | Green | White and Brown | Brown
- Points to the first lamp recommended to use more than five types of cable, DMX512 maximum distance of 100 meters, SPI maximum distance of 30 meters, more than the need to add DMX512 repeater or SPI differential.
- Points each port can be controlled with DMX512 lights 512 channels, with SPI lamps can be 512 points; DMX512 lamp circuit every 32 nodes need to add a repeater, SPI lamp circuit without the need for a differential.

BT-318D

512单机主控
512 Single Main Control

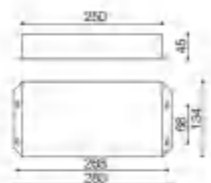

系统特点

1. 控制器输出支持标准USITT DMX512/1990通用协议和扩展DMX协议。
2. 系统支持自动、定时、节日预设效果播放。
3. 精准伽马校正算法，更加符合人体视觉感光特性，显示色彩更充分、丰富，使设计者动画或视频效果完美体现。
4. 最大支持120帧频率以保证画面高清显示和3D显示需求。
5. 控制器带按键和外配遥控器，可实现节目片段选择、整体亮度调整、白平衡调整、播放速度调整等。
6. LCD显示模块及时显示控制器参数及状态。
7. 32-65536级灰度控制，可真实还原图像色彩和细节。
8. 支持四色灯具：节能环保，色彩纯正。
9. 8端口输出，单口输出标准512通道，扩展协议带载点数由客户根据芯片特性自行测试。
10. SD卡存储，控制器最大可支持32G，最多可预设99个节目文件。
11. 支持远程在线下载、更新脱机节目。
12. 内置动画测试程序，方便客户在项目中调试和应用。

System Characteristics

1. The controller outputs support the standard USITT DMX512 / 1990 universal protocol and extended DMX protocol.
2. The system supports automatic, regular, holiday preset effect playback.
3. Precision gamma correction algorithm, more in line with the human visual sensory characteristics, display color more fully, rich! So that the designer animation or video effects perfect embodiment.
4. Maximum support 120 frame frequency to support that the screen high-definition display and 3D display requirements.
5. Controller includes buttons and external remote control, can achieve program fragment selection, the overall brightness adjustment, white balance adjustment, playback speed adjustment, etc.
6. LCD display module timely display controller parameters and status.
7. 32-65536 Level gray-scale control, can be true to restore the image color and detail.
8. Support four-color lamps: energy saving, pure color.
9. 8-port output, single-port load with unlimited points, according to the chip characteristics customers can do test by self.
10. SD card storage, the controller can support up to 32G, up to 99 preset program files.
11. Support remote online download, update the offline program.
12. Built-in animation test program, convenient for customers in the project debugging and application.

扩展性

1. 可安装目前所有Windows操作系统及支持各国语言。
2. 播放软件留有充足接口以便和其他国际通用协议兼容，并支持客户个性化设计需求。

Extensibility

1. Can be installed at present all Windows operating system and support any country language.
2. Playback software has sufficient interface to be compatible with other international protocols and supports customized design requirements.

控制器基本参数表 Controller basic parameter table

额定电压	Rated Voltage	AC 100V~240V
额定功率	Rated Power	15W
长度	Length	283mm
宽度	Width	134mm
高度	Height	45mm
固定孔间距	Fixed Hole Spacing	268mm; 68mm
标配附件	Standard Accessories	遥控器x1 / SD卡x1 / 读卡器x1 / AC电源线x1 Remote control x 1 / SD card x 1 / Card reader x 1 / AC power cord x 1

控制器安装应用

1. 脱机模式
脱机模式直接带载灯具，如下图：

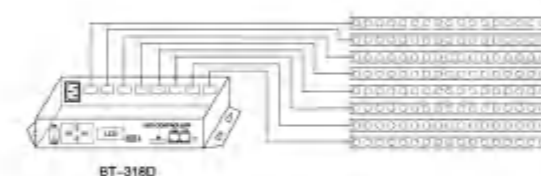

The Controller Installation and Application

1. Offline mode
Offline mode directly loaded lamps, as shown below:

2. 联/脱机一体模式
与电脑连接（联机信号优先。无联机信号时自动切换脱机信号），如下图
所示：

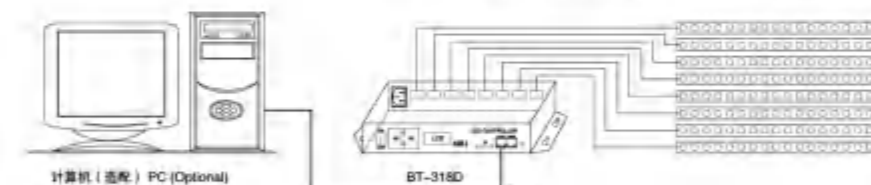

2. Connected / offline integrated model
Connect the computer (online signal priority. No online signal automatically switch off-line signal), as shown below:

注意事项

1. 电脑、控制器、网络交换机之间，用超五类网线连接，最大距离100米，超过100米，需采用光纤连接。
2. 控制器与控制器之间采用超五类网线级联，如果10米以内，可以采用直通线序，超过10米建议采用交叉线，线序如下：
568A-568A：白绿 | 绿 | 白橙 | 蓝 | 白蓝 | 橙 | 白棕 | 棕
568A-568B：白橙 | 橙 | 白绿 | 蓝 | 白蓝 | 绿 | 白棕 | 棕
3. 分控到首灯之间推荐使用超五类网线，DMX512最大距离100米，SPI最大距离30米，超过需加DMX512中继器或SPI差分器。
4. 分控每个端口可带DMX512灯具512个通道，可带SPI灯具512个点；DMX512灯具回路每32个节点需要增加一个中继器，SPI灯具回路正常无需差分器。

Matters Needing Attention

1. Computers, controllers, network switches, with more than five types of cable connections, the maximum distance of 100 meters, more than 100 meters, the need for optical fiber connection.
2. Between the controller and the controller to use more than five kinds of network cable cascade, if within 10 meters, you can use the straight line sequence, more than 10 meters recommend the use of cross line, the line is as follows:
568A-568A: White and Green | Green | White and Orange | Blue | White and Blue | Orange | White and Brown | Brown
568A-568B: White and Orange | Orange | White and Green | Blue | White and Blue | Green | White and Brown | Brown
3. Points to the first lamp recommended to use more than five types of cable, DMX512 maximum distance of 100 meters, SPI maximum distance of 30 meters, more than the need to add DMX512 repeater or SPI differential.
4. Points each port can be controlled with DMX512 lights 512 channels, with SPI lamps can be 512 points; DMX512 lamp circuit every 32 nodes need to add a repeater, SPI lamp circuit without the need for a differential.

BT-502

脱机控制器
Offline Controller

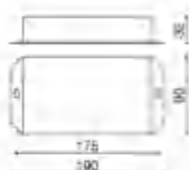

系统特点

- 32~65536级灰度控制，可真实还原图像色彩和细节。
- 采用按键快速设置控制器参数，如驱动芯片类型、控制器编号、节目片段、播放速度、灯具亮度。
- LCD显示模块及时显示控制器参数及状态。
- 支持遥控器设置控制器参数，如驱动芯片类型、控制器编号、节目片段、播放速度及跳帧频率、灯具亮度及开关机时间。
- 支持SD卡存储动画数据，方便快捷。
- 节目片段可独立设置年、月、日、时间及星期定时播放。
- 控制器输出具备2端口SPI信号输出和2端口DMX512信号输出。
- 支持对MR-DMX05、DMX512AP、UCS512等DMX512解码芯片的编址功能。
- 多种驱动芯片控制集成一体，通过软件设置更改芯片类型、时钟频率、占空比、灰度级等参数。
- 控制器之间支持交流工频同步、同步线同步等多种同步方式。
- 支持直流或交流宽电压供电。
- 具备时间锁加密功能。
- 支持环境光控、音频光控等传感模块（选配）应用，交互式便捷调整灯具亮度。

System Characteristics

- 32~65536 Level gray-scale control, can be true to restore the image color and detail.
- Use the button to quickly set the controller parameters, such as driver chip type, controller number, program clips, playback speed, lamp brightness.
- LCD display module timely display controller parameters and status.
- Support the remote controller to set the controller parameters, such as driver chip type, controller number, program clips, playback speed and frame frequency, lamp brightness and switch machine time.
- Support SD card storage animation data, convenient and quick.
- Program clips can be set independently of the year, month, day, time and week for timed playback.
- Controller output with 2-port SPI signal output and 2-port DMX512 signal output.
- Support the addressing function of DMX512 decoder chip such as MR-DMX05, DMX512AP, UCS512.
- A variety of integrated control chip driver, through the software settings to change the chip type, clock frequency, duty cycle, grayscale and other parameters.
- Between the controller support AC frequency synchronization, synchronous line synchronization and other synchronization methods.
- Supports DC or AC wide voltage power supply.
- With time lock encryption.
- Support environmental light control, audio light control and other sensor modules (optional) applications, interactive and convenient adjustment of lamp brightness.

控制器基本参数表 Controller Basic Parameter Table

控制颜色	Controlling Colour	RGB三基色、RGBW四基色、全彩显示	RGB three primary colors, RGBW four primary colors, full-color display
控制点数	Number Of Control Points	单口控制1024像素 (DMX为512像素)	Single-port control 1024 pixels (DMX is 512 pixels)
输出接口	Output Interface	同步串行移位数据信号x2, 兼容DMX512信号x2 (不可同时输出)	Synchronous serial shift data signal x 2, Compatible with DMX512 signal x 2 (not simultaneously output)
灰度级别	Gray-scale Level	256~65536级	256~65536 level
输入电压	Input Voltage	AC 12V / DC 7.5V~24V / DC 5V	
额定功率	Rated Power	2W	
SD卡容量	SD Card Capacity	4GB (出厂标配)	4GB Factory standard
单体尺寸	Monomer Size	190x96.3x32.5mm	
接口形式	Interface Form	3Pin端子x5 4Pin端子x2	3Pin Terminal x 5 4Pin Terminal x 2

控制器安装应用

在BT-502控制器应用中，可分为同步线应用及交流工频同步等多种应用模式。

1. 直流同步线应用

在BT-502控制器的同步线应用中，在BT-502控制器之间采用同步线的方式实现同步控制。在此应用模式下，可通过设置1号控制器来统一实现对后续控制器的控制，例如：片段选择、速度调整等设置。

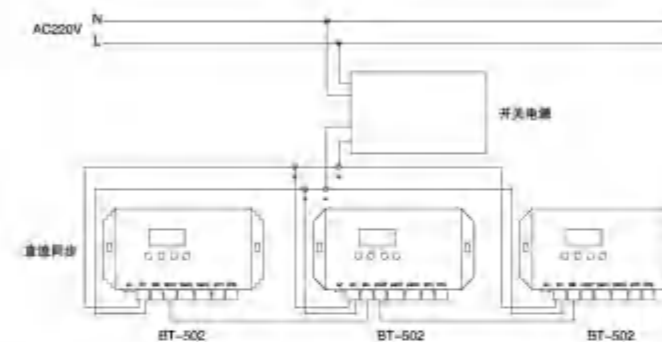

2. 交流工频同步应用

在交流工频同步应用中，控制器采用交流电供电 (AC 12V)，BT-502控制器支持交流电同步，将项目中所有控制器采用一个开关来控制上断电，通过同时上电来实现同步控制。

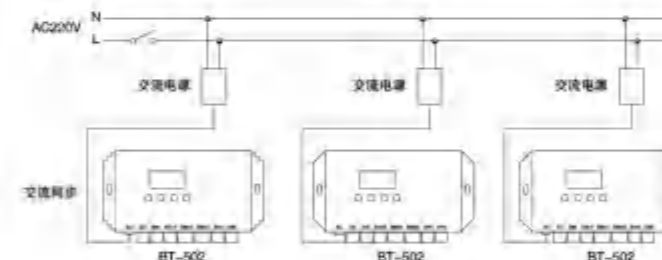

注意事项

- 电脑、控制器、网络交换机之间，用超五类网线连接，最大距离100米，超过100米，需采用光纤连接。
- 控制器与控制器之间采用超五类网线级联，如果10米以内，可以采用直通线序，超过10米建议采用交叉线，线序如下：
568A~568A：白绿 | 绿 | 白橙 | 蓝 | 白蓝 | 橙 | 白棕 | 棕
568A~568B：白橙 | 橙 | 白绿 | 蓝 | 白蓝 | 绿 | 白棕 | 棕
- 分控到首灯之间推荐使用超五类网线，DMX512最大距离100米，SPI最大距离30米，超过需加DMX512中继器或SPI差分器。
- 分控每个端口可带DMX512灯具512个通道，可带SPI灯具512个点；DMX512灯具回路每32个节点需要增加一个中继器，SPI灯具回路正常无需差分器。

The Controller Installation and Application

In the BT-502 controller application, can be divided into sync lines and AC frequency synchronization applications and other applications.

1. DC synchronous line application

In the synchronous line application of the BT-502 controller, synchronous control is implemented between the BT-502 controllers using synchronous lines. In this application mode, you can set the controller to achieve unified control of the follow-up controller, such as: fragment selection, speed adjustment and other settings.

2. AC frequency synchronization application

In the AC frequency synchronization application, the controller uses the AC power supply (AC 12V), BT-502 controller supports AC synchronization, the project will use a controller to control the switch off, through the simultaneous power to achieve synchronous control.

Matters Needing Attention

- Computers, controllers, network switches, with more than five types of cable connections, the maximum distance of 100 meters, more than 100 meters, the need for optical fiber connection.
- Between the controller and the controller to use more than five kinds of network cable cascade, if within 10 meters, you can use the straight line sequence, more than 10 meters recommend the use of cross line, the line is as follows:
568A~568A: White and Green | Green | White and Orange | Blue | White and Blue | Orange | White and Brown | Brown
568A~568B: White and Orange | Orange | White and Green | Blue | White and Blue | Green | White and Brown | Brown
- Points to the first lamp recommended to use more than five types of cable, DMX512 maximum distance of 100 meters, SPI maximum distance of 30 meters, more than the need to add DMX512 repeater or SPI differential.
- Points each port can be controlled with DMX512 lights 512 channels, with SPI lamps can be 512 points; DMX512 lamp circuit every 32 nodes need to add a repeater, SPI lamp circuit without the need for a differential.

BT-502T

BTS基站同步控制器

BTS Base Station Synchronization Controller

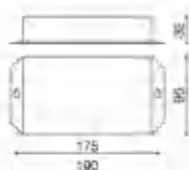

系统特点

- 32-65536级灰度控制，可真实还原图像色彩和细节。
- 采用按键快速设置控制器参数，如驱动芯片类型、控制器编号、节目片段、播放速度、灯具亮度。
- 通过接收BTS基站信号可实现多台控制器的无线联动同步，满足客户在多层楼宇无法连线的情况下实现多台控制器同步的需求。
- LCD显示模块及时显示控制器参数及状态。
- 支持遥控器设置控制器参数，如驱动芯片类型、控制器编号、节目片段、播放速度及跳帧频率、灯具亮度及开关机时间。
- 支持SD卡存储动画数据，方便快捷。
- 节目片段可独立设置年、月、日、时间及星期定时播放。
- 控制器输出具备2端口SPI信号输出和2端口DMX512信号输出。
- 支持对BT-DMX05、DMX512AP、UCS512等DMX512解码芯片的编址功能。
- 多种驱动芯片控制集成一体，通过软件设置更改芯片类型、时钟频率、占空比、灰度级等参数。

System Characteristics

- 32-65536 Level gray-scale control, can be true to restore the image color and detail.
- Use the button to quickly set the controller parameters, such as driver chip type, controller number, program clips, playback speed, lamp brightness.
- By receiving BTS base station signals can be achieved more than one controller wireless synchronization to meet the customers' requirements of multiple controllers synchronization needs when customer can not be connected between buildings.
- LCD display module timely display controller parameters and status.
- Support the remote controller to set the controller parameters, such as driver chip type, controller number, program clips, playback speed and frame frequency, lamp brightness and switch machine time.
- Support SD card storage animation data, convenient and quick.
- Program clips can be set independently of the year, month, day, time and week for timed playback.
- Controller output with 2-port SPI signal output and 2-port DMX512 signal output.
- Support the addressing function of DMX512 decoder chip such as BT-DMX05, DMX512AP, UCS512.
- A variety of integrated control chip driver, through the software settings to change the chip type, clock frequency, duty cycle, grayscale and other parameters.

11. 控制器之间支持交流工频同步、同步线同步等多种同步方式。
12. 支持直流或交流宽电压供电。
13. 具备时间锁加密功能。
14. 支持环境光控、音频光控等传感模块（选配）应用，交互式便捷调整灯具亮度。

11. Between the controller support AC frequency synchronization, synchronous line synchronization and other synchronization methods.
12. Supports DC or AC wide voltage power supply.
13. With time lock encryption.
14. Support environmental light control, audio light control and other sensor modules (optional) applications, interactive and convenient adjustment of lamp brightness.

控制器基本参数表 Controller Basic Parameter Table

控制颜色	Controlling Colour	RGB三基色、RGBW四基色、全彩显示	RGB three primary colors, RGBW four primary colors, full-color display
控制点数	Number Of Control Points	单口控制1024像素（DMX为512像素）	Single-port control 1024 pixels (DMX is 512 pixels)
输出接口	Output Interface	同步串行移位数据信号x2, 兼容DMX512信号x2（不可同时输出）	Synchronous serial shift data signal x 2, Compatible with DMX512 signal x 2 (not simultaneously output)
灰度级别	Gray-scale Level	32-65536级	32-65536 level
输入电压	Input Voltage	AC 12V / DC 7.5V-24V / DC 5V	
额定功率	Rated Power	2W	
SD卡容量	SD Card Capacity	4GB（出厂标配）	4GB Factory standard
单体尺寸	Monomer Size	190x138x187mm	
接口形式	Interface Form	3Pin端子x5 4Pin端子x2	3Pin Terminal x 5 4Pin Terminal x 2

控制器安装应用 The Controller Installation and Application



注意事项

- 电脑、控制器、网络交换机之间，用超五类网线连接，最大距离100米，超过100米，需采用光纤连接。
- 控制器与控制器之间采用超五类网线级联，如果10米以内，可以采用直通线序，超过10米建议采用交叉线，线序如下：
568A-568A：白绿|绿|白橙|蓝|白蓝|橙|白棕|棕
568A-568B：白橙|橙|白绿|蓝|白蓝|绿|白棕|棕
- 分控到首灯之间推荐使用超五类网线，DMX512最大距离100米，SPI最大距离30米，超过需加DMX512中继器或SPI差分器。
- 分控每个端口可带DMX512灯具512个通道，可带SPI灯具512个点；DMX512灯具回路每32个节点需要增加一个中继器，SPI灯具回路正常无需差分器。

Matters Needing Attention

- Computers, controllers, network switches, with more than five types of cable connections, the maximum distance of 100 meters, more than 100 meters, the need for optical fiber connection.
- Between the controller and the controller to use more than five kinds of network cable cascade, if within 10 meters, you can use the straight line sequence, more than 10 meters recommend the use of cross line, the line is as follows:
568A-568A: White and Green | Green | White and Orange | Blue | White and Blue | Orange | White and Brown | Brown
568A-568B: White and Orange | Orange | White and Green | Blue | White and Blue | Green | White and Brown | Brown
- Points to the first lamp recommended to use more than five types of cable, DMX512 maximum distance of 100 meters, SPI maximum distance of 30 meters, more than the need to add DMX512 repeater or SPI differential.
- Points each port can be controlled with DMX512 lights 512 channels, with SPI lamps can be 512 points; DMX512 lamp circuit every 32 nodes need to add a repeater, SPI lamp circuit without the need for a differential.

BT-DMXDC

编码器
Encoder



系统特点

本产品是针对本公司的解码芯片及常用的DMX512解码芯片而设计的一款编码器，可对驱动模块进行级联编码，编码方式方便简单，其特点如下：

- 供电电压为DC5~24V。
- 配有标准的手机MICRO-USB接口，配带移动电源，可方便操作。
- 支持10种编码模式:3R、3S、3H、3G、3E、AP-N、UCS、UCS-C、SM-AB、SM-4。
- 可以选择按灯具或按地址方式编码。
- 具有地址测试功能。
- 此编码器有编码和播放2种模式。
- 配有LCD显示屏，显示当前操作状态。
- EMC电磁兼容设计，具有良好的抗干扰能力。

System Characteristics

This product is for the company's decoder chip and commonly used DMX512 decoder chip designed for an encoder, the drive module can be concatenated coding, coding is simple and convenient, and its characteristics are as follows.

- Power supply voltage DC5~24V.
- Equipped with a standard mobile phone MICRO-USB interface, with mobile power, easy to operate.
- Support 10 encoding modes: 3R, 3S, 3H, 3G, 3E, AP-N, UCS, UCS-C, SM-AB, SM-4.
- Can choose to press the lamp or by address mode encoding.
- Address test function.
- Two modes of encoding and playback.
- Equipped with LCD display, showing the current operating state.
- EMC electromagnetic compatibility design, with good anti-interference ability.

基本参数表 Basic Parameter Table

尺寸	Size	115x77x34mm
重量	Weight	200g
外观颜色	Appearance Color	灰色 Grey
工作电源	Working Power	DC5~24V
消耗功率	Power Consumption	最大5W Max 5W
输出控制端口	Output Control Port	1 port
输出数据信号	Output Data Signal	RS485
储存介面	Storage Interface	SD卡 SD Card
灰度级别	Grayscale Level	RGB各256级 RGB 256 levels.
工作温度	Operating Temperature	-20~65°C
最大控制像素	Maximum Control Pixel	512像素 512 Pixel
可控IC	Controllable IC	铭明鑫解码芯片及其它常用DMX512解码芯片 Yu Ming decoder chips and other commonly used DMX512 decoder chip

BT-WT02

手持编址器
Hand - Held Addressing Device



系统特点

- 支持多种DMX512芯片的编址，可指定起始通道，单个芯片的带载通道、及灯具编号。
- 采用按键快速设置各种技术参数，如DMX512通道及波特率、多种内部测试动画模式、及SD卡内场景文件等。
- 支持SD卡存储动画数据，并可指定播放模式，及指定某个场景等。
- 具备1端口DMX512信号输出，其编址信号兼容支持差分信号模式。
- 具备干电池仓供电（5枚5号干电池），并Micro-B型USB接口（常规android手机供电USB端口）供电。
- 支持供电开关选择关闭、USB接口DC供电、及电池仓供电。故在手持编址器电池仓内电源耗尽时，可选用UBS手机充电宝等设备选用另一种供电模式。
- 支持多种DMX512协议，如：BT-DMX05、DMX512AP、UCS512、SM16512、TM512。

System Characteristics

- Support a variety of DMX512 chip addressing, you can specify the starting channel, a single chip with a load channel, and the lamp number.
- Using the button to quickly set the various technical parameters, such as DMX512 channel and baud rate, a variety of internal test animation mode, and SD card scene files.
- Support SD card storage animation data, and can specify the playback mode, and specify a scene and so on.
- With a 1-port DMX512 signal output, the addressing signal compatible to support differential signal mode.
- (5 batteries), and Micro-B-type USB interface (conventional android phone-powered USB port) power supply.
- Support power supply switch off, USB DC power supply, and battery power supply. Therefore, in the hand-held address of the battery compartment when the power supply is exhausted, you can use UBS mobile phone charging treasure and other equipment selection of another power supply mode.
- Support multiple DMX512 protocols, such as: BT-DMX05, DMX512AP, UCS512, SM16512, TM512.

基本参数表 Basic Parameter Table

波特率	Baud Rate	250K (标准协议)~500K 250K (Standard protocol)~500K
通道数	Number Of Channels	128~2048通道，其中512通道（标准协议） 128~2048 channels, of which 512 channels (Standard protocol)
输出接口	Output Interface	DMX512信号x1 DMX512 signal x 1
供电方式	Power Supply	干电池供电（5枚5号干电池），Micro-B型USB供电 Battery-powered (5 No. 5 dry batteries), Micro-B-type USB-powered
SD卡容量	SD Card Capacity	8GB (出厂标配) 8GB (Factory standard)
单体尺寸	Monomer Size	213x98.5x34.5mm
接口形式	Interface Form	5Pin端子x1, Micro-B USB, SD卡接口 5Pin terminal x 1, Micro-B USB, SD card interface

BT-ZJ51W

中继器
Repeater

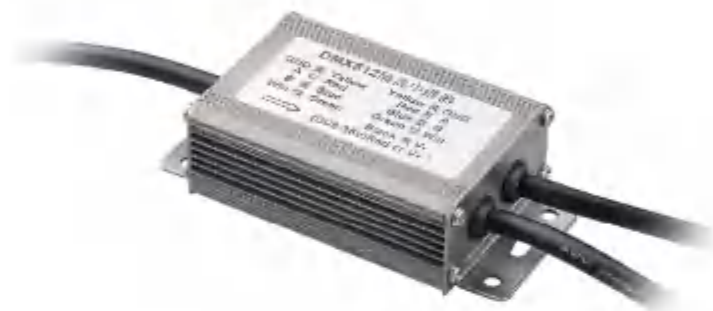
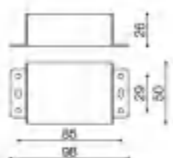

系统特点

- BT-ZJ51W中继器应用于对DMX512信号经远距离传输衰减后进行信号整形放大处理,具有延长信号传输距离的作用。
- 中继器的输入端与输出端之间采用磁偶隔离保护技术,因此可避免因控制线路等设备出现故障时可能产生的高电压烧毁精密器件,确保其安全运行,不仅可以在应用中保护控制器,同时也保证DMX信号能正常传送到各种灯光设备,提高整个控制系统的可靠稳定性。
- BT-ZJ51W中继器具备编址线,支持编址线隔离保护功能,能够有效保护数据线路中灯具及控制器等设备,并提高DMX512灯具的编址成功率。
- DMX512信号中继器BT-ZJ51W中继器主要应用于DMX512控制器与首位DMX512灯具之间,其安装位置应接近首位灯具,距离不超过2m。
- 在DMX512灯具信号级联链中,按照一般原则,每32个DMX512灯具,即可加装一套BT-ZJ51W中继器。

System Characteristics

- BT-ZJ51W repeater used in the DMX512 signal attenuation by long-distance transmission after the signal shaping processing, with extended signal transmission distance
- Repeater between the input and output using magnetic isolation protection technology, it can avoid the control lines and other equipment failure may produce high-voltage burned precision devices to ensure the safe operation, not only in the application of protection and control, But also to ensure that the DMX signal can be transmitted to a variety of lighting equipment, improve the reliability of the entire control system stability
- BT-ZJ51W repeater with address line, support address line isolation protection, can effectively protect the data lines in the lamps and fixtures and other equipment, and improve the DMX512 lamp addressing success rate
- DMX512 signal repeater BT-ZJ51W repeater is mainly used in DMX512 controller and the first DMX512 lamps, the installation location should be close to the first fixture, the distance does not exceed 2m
- In the DMX512 lighting signal cascade chain, according to the general principle, every 32 DMX512 lamps and lanterns, may install a set of BT-ZJ51W repeater.

控制器基本参数表 Controller Basic Parameter Table

信号类型	Signal Type	DMX512信号 DMX512 signal
输出电压	Output Voltage	DC 6V~36V
额定功率	Rated Power	≤2W
信号隔离类型	Signal Isolation Type	磁隔离方式 Magnetic isolation mode
编址隔离类型	Address Isolation Type	磁隔离方式 Magnetic isolation method
输入端定义	Input Definition	地线、数据+(A)、数据-(B)、编址输入(Win) Ground, data + (A), data - (B), addressing input (Win)
输出端定义	Output Definition	地线、数据+(A)、数据-(B)、编址输出(Wout) Ground, data + (A), data - (B), addressing output

BT-CF01

差分器
Difference Device

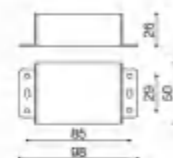

系统特点

- BT-CF01双向差分板支持将TTL电平信号转化为差分信号或由差分信号转化为TTL电平信号,利用差分信号传输距离远的特性,实现了控制系统到灯具之间或灯具到灯具间的远距离传输。
- BT-CF01双向差分板结构简单,使用方便,传输稳定,体积小,支持SPI协议控制器差分信号输出与TTL电平信号输出,有效的保证大距离信号传输的稳定性。

System Characteristics

- The BT-CF01 bidirectional differential board supports the conversion of TTL level signals to differential signals or from differential signals to TTL level signals, The use of differential signal transmission distance of the characteristics of the control system to achieve between the lamps or lamps and lanterns between the long-distance transmission.
- BT-CF01 bidirectional differential board is simple, easy to use, stable transmission, small size, support SPI protocol controller differential signal output and TTL level signal output, effectively guarantee the stability of large distance signal transmission.

控制器基本参数表 Controller Basic Parameter Table

信号类型	Signal Type	TTL电平信号、DMX512差分信号 TTL level signal, DMX512 differential signal
输出电压	Output Voltage	DC 5V或6~36V DC 5V or 6~36V
额定功率	Rated Power	≤2W
输入端定义	Input Definition	地线(GND)、数据+(DATA+), 数据-(DATA-), 时钟+(CLK+), 时钟-(CLK-) (GND), data + (DATA +), data - (DATA -), clock + (CLK +), clock - (CLK -)
输出端定义	Output Definition	地线(GND)、数据(DATA), 数据(CLK) Ground (GND), data (DATA), data (CLK)