



COMPANIONTM OEM HITCH

YOUR TOWING ADVENTURE BEGINS

An aerial photograph of a deep, rugged canyon with a river winding through its center. The scene is captured at sunset, with a warm orange and yellow glow on the horizon. The canyon walls are layered with reddish-brown rock. The BW logo is centered in the upper half of the image.

BW

TRAILER HITCHES

TOWING ADVENTURE



DON'T WORRY

YOUR HITCH WAS MADE RIGHT HERE.

You've got a lot riding on your hitch and the only thing keeping your truck and your trailer connected are those relatively small pieces of engineered steel. The hitch matters to your safety and the safety of our roads.

That's why we treat the manufacture of your trailer hitch with the respect it deserves. For one, we insist on American-made steel, like the sheet steel we buy from U.S. Steel out of Gary, Indiana or the round bar that becomes the gooseneck ball made at a mill in Norfolk, Nebraska. Where the strength and flexibility of the steel can mean life or death, we trust the U.S. steel mills with their finely controlled processes and specifications we can trust.

A hitch is only as good as the welds holding it together. We insist on making those welds under our roof. And the hard-working, skilled Americans that make the welds do so according to the American Society for Testing and Materials Welding Standard.

Thank you for putting your trust in us.

- Joe Works

WELCOME TO THE FAMILY.
YOU MADE A GREAT CHOICE.



SIMPLE GOALS:

MAKE IT SAFE,
MAKE THE RIDE SMOOTH,
AND MAKE IT REMOVABLE.



Cam action latching handle
for easy release, even when
parked on unlevel sites



Polyurethane bushings
provide a quiet, rattle-free
towing experience

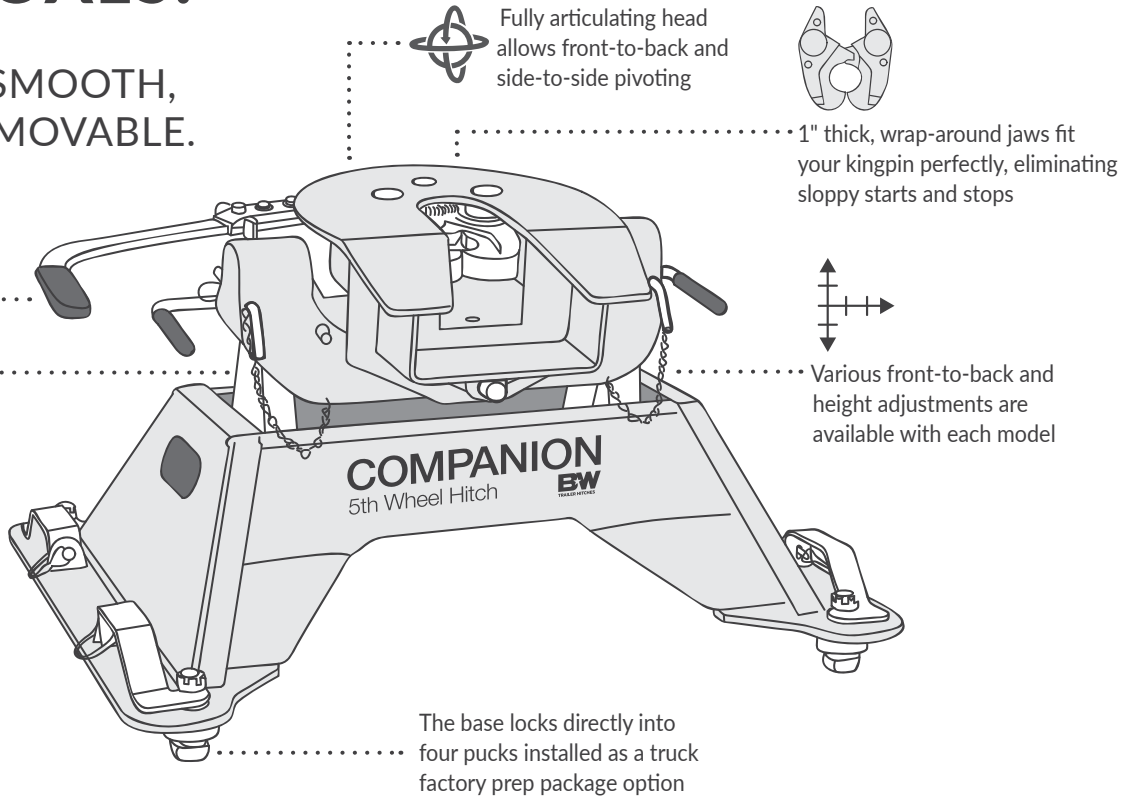

Fully articulating head
allows front-to-back and
side-to-side pivoting

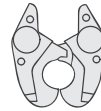

1" thick, wrap-around jaws fit
your kingpin perfectly, eliminating
sloppy starts and stops



Various front-to-back and
height adjustments are
available with each model

The base locks directly into
four pucks installed as a truck
factory prep package option

THE B&W DIFFERENCE

Our jaws are a full inch thick cast material and the left and right jaw are machined together to create a precise connection to your kingpin. Then the jaws are wired together, plated, and assembled as a pair. Learn more about this process on the B&W Trailer Hitches' YouTube channel.

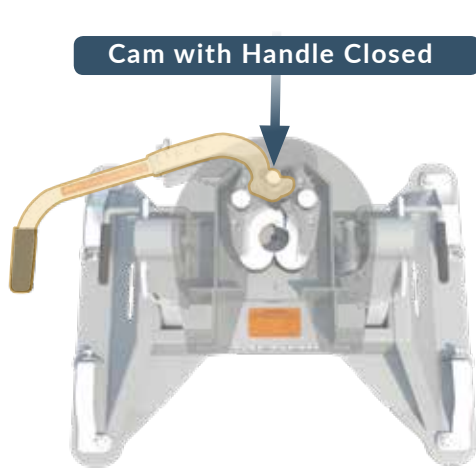

We designed our jaws and handle to work with a cam mechanism. When the handle is pinned closed, the cam keeps the jaws from opening.

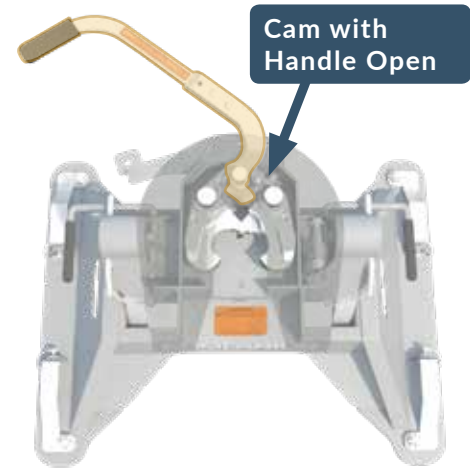

When the handle is open the cam allows the jaws to open, **even if you are in a bind** because of unlevel ground. If the handle is open, you may go ahead and drive out of the jaws. They will open as you pull away.

ABSORBING THE SHOCK

The Companion allows side-to-side movement and articulation when you are maneuvering or on uneven ground.

The shock absorber, located on one side of the coupler, cushions that movement and allows gentle side-to-side movement without the slamming. Sit back, and enjoy the ride.

JUST HOW TIGHT ARE OUR PROCESSES?

Machining on the jaws must be $\pm .002$ of an inch. (A piece of paper is about twice that thick.)

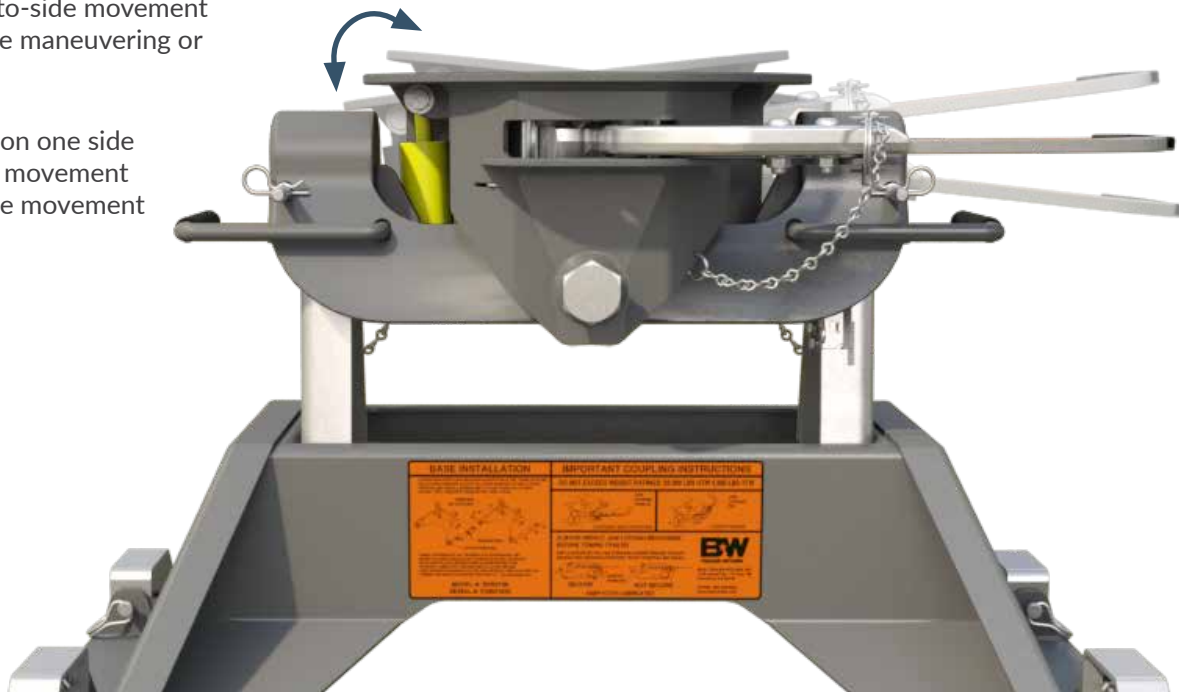









ADJUST ARMS FOR PROPER CLEARANCE

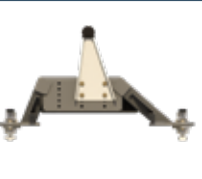
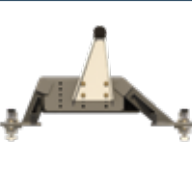
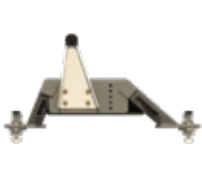

INSTALLING PIVOT ARMS

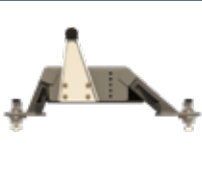
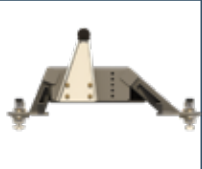
Mount the pivot arms using one of the locations illustrated. These locations allow flexibility in coupler height (vertical adjustment) and distance from the cab (horizontal adjustment). Choose a location so that your trailer will be as level as possible and have adequate turning clearance while towing.

Ram Companion Options

		Horizontal Adjustment			
		4" Behind Axle	2" Behind Axle	Over Axle	2" in Front of Axle
Vertical Adjustment	Highest Position (19")				
	Medium Position (18")				
	Lowest Position (17")				

Ford & GM Companion Options

		Horizontal Adjustment	
		FORD	GM
Vertical Adjustment	Highest Position (18 3/4")	Kingpin 3" in Front of Axle	Kingpin 1" in Front of Axle
	Medium Position (17 3/4")	Kingpin 2" Behind Axle	Kingpin Over Axle
	Lowest Position (16 3/4")		



WATCH YOUR CAB

Check that you know how sharply you can turn before encountering your cab with your fifth wheel. There are several factors that affect this angle including: the pin box location, the width of trailer, and the shape of the trailer nose.



WATCH YOUR BED SIDES

Check for clearance between your fifth wheel and the sides of your truck bed. Allow several inches so that uneven ground doesn't cause contact. Adjust the Companion to a higher position or your kingpin (if it is adjustable) to a lower position to affect this distance.

INSTALLING THE COMPANION

For more information refer to your instruction sheet.

1. Remove the latch pins from each handle and rotate the handles out. Place the Companion base over the attachment points and carefully lower it until the latch cams pass through the floor and the base rests flat against the top of the attachment points.

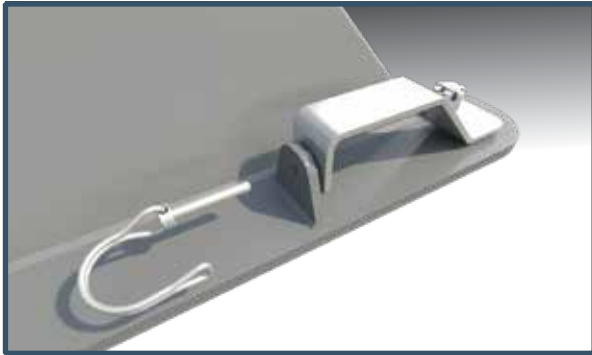

2. Once the base is in place, turn each of the latch handles so the base is drawn firmly down onto the attachment points. You should feel some resistance with turning the handles as the base is drawn down. If any of the handles will not close or if they rotate freely with no resistance, the tension on the latch handles will need to be adjusted.



Place Base in Receiver

If your handle needs tension adjustment. With a pair of needle nose pliers, un-bend and remove the cotter pin installed at the top of the latch cam. Then adjust the height of the castle nut.

To loosen the latch handle (handle is difficult to rotate or cannot be closed) rotate the castle nut counter-clockwise (loosen) with a 15/16" wrench or socket.

To tighten the latch handle (handle rotates without any resistance) rotate the castle nut clockwise (tighten) with a 15/16" wrench or socket.

Use trial and error to find the correct latch tension for each attachment point. After the tension is set, replace the cotter pin and re-bend the ends. You may have to rotate the castle nut slightly to allow the cotter pin to pass through.



3. With the base firmly held down and each latch handle closed, replace the latch pins removed in step one. Place the coupler on the pivot arms and pin in place.



Place the Coupler on Pivot Arms

REMOVING THE COMPANION

1. Unpin and remove the coupler head.



2. Remove the latch pins from each of the handles.

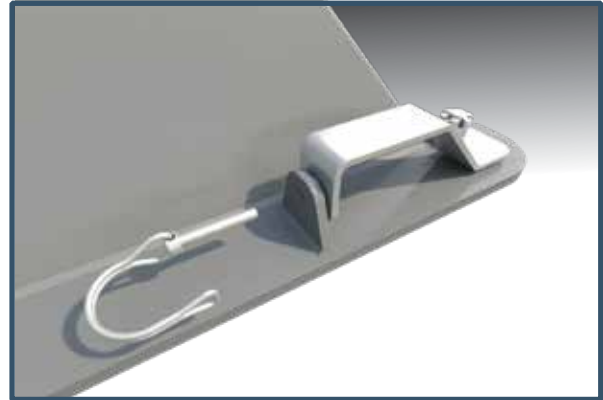

3. Turn latch handles to the open position.



4. Lift the base straight up and out of the attachment points.



KNOW BEFORE TOWING

Your Companion Slider is rated to tow 20,000 lbs. It is important to learn your manufacturer's weight limits (truck, fifth wheel, and hitch). Detailed instructions for comparing these weight limits to the actual weights of your set-up are found on the next few pages.

Truck manufacturers give their trucks specific ratings after extensive testing. Tow ratings are based on the capacity of a truck's engine, transmission and brakes to safely handle the weight of a loaded trailer. For Gross Weight Ratings, the truck's tires, frame, and suspension must be able to bear the load.

Even though your Companion Slider fifth wheel hitch is rated to tow 20,000 lbs., never exceed your truck's weight ratings.

All of our hitches are tested for both strength and durability according to SAE J-2638, the latest standard for fifth wheel and gooseneck hitches.



Without proper knowledge, towing can be a dangerous activity. If you are new to towing, we recommend

***"The Trailer Handbook:
A Guide to Understanding
Trailer and Towing Safety"***

from the National Association of Trailer Manufacturers. This booklet is available by going to NATM.com.

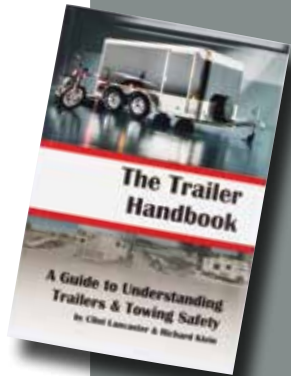



FINDING MANUFACTURER WEIGHT LIMITS

Locate your **Gross Vehicle Weight Rating (GVWR)**.

This is the maximum allowable weight of the fully loaded vehicle.

You can find this, most likely, on the sticker inside your driver's side door.

You should also locate your **Gross Combined Weight Rating (GCWR)**

from your truck manufacturer. This is the maximum allowable weight of the tow vehicle and the loaded trailer including all cargo and passengers.

Find this in your owner's manual or by calling your truck dealer.

And finally, locate your **Max Tow Rating**.

It is sometimes located in the truck owner's manual or look for it at trailerlife.com/trailer-towing-guides.

B&W recommends that your **Vertical Towing Weight Rating (VTWR)**

for your hitch be no more than 25% of your truck's Max Tow Rating.

Make this calculation: $\text{Max Tow Rating} \times .25 = \text{VTWR}$

GVWR

GCWR

Max Tow Rating

VTWR

Once you have located your truck manufacturer's weight ratings, transfer them into the corresponding boxes on the next two pages.

FINDING YOUR ACTUAL WEIGHTS

Take your loaded truck and loaded trailer to a scale at a truck stop, quarry or material supply center. For a small fee you can weigh your tow vehicle and trailer on their scale.



	MUST BE MORE THAN	
--	-------------------	--

GVWR *

your GVW

1. Find your **GVW** (Gross Vehicle Weight)

Weigh just your truck with a full tank of gas, all your passengers and items in the cab and truck bed with your trailer loaded and attached, but not on the scale.

Do Not Exceed Your Truck Manufacturer's **GVWR**



	MUST BE MORE THAN	
--	-------------------	--

GCWR *

your GCW

2. Find your **GCW** (Gross Combined Weight)

Weigh your fully loaded truck and trailer including all cargo, a full tank of gas and passengers.

Do Not Exceed Your Truck Manufacturer's **GCWR**

* Transfer Manufacturer's Ratings from previous page.



3. Find your **Towing Weight**

Weigh your loaded truck without the trailer attached. This is your truck weight.

Subtract your **Truck Weight** from your **GCW**.

This is your towing weight.



MAX TOW RATING *

your Towing Weight



4. Find your **VTW** (Vertical Tow Weight) also known as Tongue Weight

Subtract your **Truck Weight** from your **GVW**.



VTWR *

your VTW

IMPORTANT!

Even though you may be under your vehicle's Max Towing Rating, when your Gross Vehicle Weight (GVW) goes up, (more passengers, more cargo) your ability to tow the Max Towing Rating may not be possible, because:

THE GROSS COMBINED WEIGHT RATING (GCWR) MUST NOT BE EXCEEDED.

ATTACHING YOUR TRAILER

1. Remove the coupler cam handle safety pin and use the cam handle to open the coupler jaws.



2. Adjust the height of the fifth wheel trailer using the jack so that the kingpin plate is slightly lower than the top of the coupler.
3. Back the truck towards the trailer, centering the trailer's kingpin in the coupler, until the kingpin has engaged the jaws.



4. Ensure that the coupler cam handle has completely closed and insert the cam handle safety pin through the cam handle and the coupler.



5. Hook up brake and lighting connections before towing.



CONDUCT A SAFETY TEST

Before towing, you should conduct a safety test to make certain that you are properly hitched.

1. Place the truck in 'park', and put the emergency brake on.

The trailer should have wheels blocked:

Wheel Blocks



The trailer's landing gear should be firmly on the ground, supporting the weight of the trailer:

Landing Gear

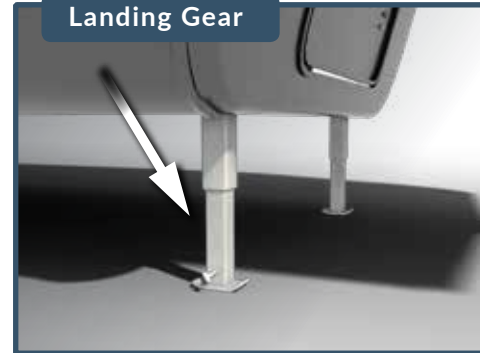



2. Make sure that no one is between the truck and the trailer. Release the emergency brake and apply the trailer brakes.
3. Try to pull the trailer forward with the truck. If the trailer is properly hooked up, the wheel blocks and trailer brakes should not allow the truck to move forward.
4. If the trailer is not hitched correctly, the trailer will separate from the truck. However, with the landing gear resting firmly on the ground, it will support the trailer and not allow it to drop or fall on the truck sides.



DISCONNECTING YOUR TRAILER

1. Lower landing gear and block the trailer wheels.

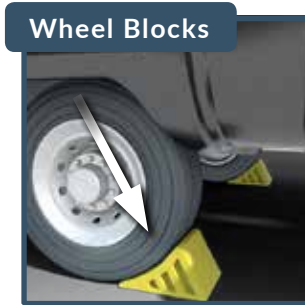

2. Raise the trailer until the tongue weight is removed from the truck.

3. Unpin the coupler handle and rotate to the open position to release the jaws.



4. Use the safety pin to lock the handle in the open position and when you are sure that the landing gear will support the trailer, move the truck forward to release the jaws from the kingpin.
5. If the jaws do not open, that may be an indication that there is still upward pressure on the jaws. Readjusting the landing gear may relieve that pressure. However, if the handle is open, the jaws will always open as you pull away.

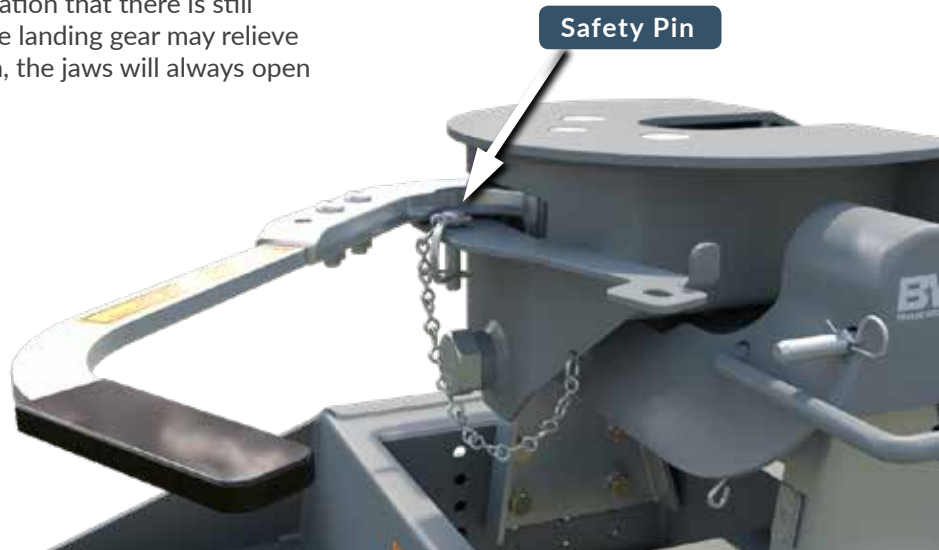

HITCH MAINTENANCE

There are four places on the Companion that you should lubricate regularly.

1. Grease the saddle through the grease zerk approximately every six months with multi-purpose grease. This allows the coupler to pivot freely.

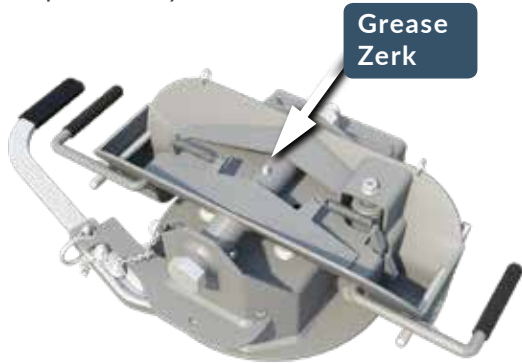

2. Spread a thin layer of multi-purpose grease around the inside surface of the jaws where they grasp the kingpin. You may also want to apply some grease to the kingpin on your trailer.

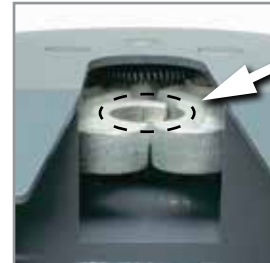

**Grease
Inside
of Jaws**

3. As needed, grease the polyurethane bushings with multi-purpose grease.



BW[®]

TRAILER HITCHES

MULTI-PURPOSE WHITE LITHIUM GREASE

- Lubricates and Protects
- Water Resistant
- Single Use

**LOVE YOUR HITCH
LONGER!**

Net Wt. 7 g

Here is a grease packet to get you started. If you need more, feel free to contact us at 800.248.6564

4. Lubricate the top surface of the coupler with automotive type chassis grease or use a nylon lube plate to provide a lubricated surface.



LUBE PLATES

Lube plates come in all sizes. We recommend a 10" version, like this one infused with graphite, available online at bwtrailerhitches.com/product/graphite-lube-plate



OUR APPROACH TO WARRANTY

It is our policy to stand behind the products we build.

We are confident that our products are made without design or quality defects. However, if you believe that one of our products doesn't live up to our standards, we would make it right with you, our customer.

If your product suffers damage because of an accident or misuse on your part, we would work with you to get you back on the road with as little cost and hassle to you as possible, because that is just being a good neighbor.

We can't keep your product in 'new' condition and your product and the finish will age through normal wear and tear. You should only use our products in the manner intended in their design. Most of our products require some routine maintenance to continue to work as they did when they were new.

We appreciate it when our customers register their products with us. However, we offer our warranty regardless.

To register your product with us,
please go to www.bwtrailerhitches.com/warranty
or call us at **800-248-6564**.



OUR AMERICAN DREAM STORY

Like many, ours began in a garage in 1987, with two men and an idea. Roger Baker and Joe Works (the 'B' and the 'W') began building custom truck beds and quickly recognized a way to improve the inconvenience of a gooseneck ball permanently welded in the bed. They designed a gooseneck hitch with the mounting hardware underneath the bed and a ball that turned over and stowed where it was used. The Turnoverball® Gooseneck Hitch was born.

A few years later, they applied the same concepts to fifth-wheel hitches. Using the same under-bed mounting hardware and hole in the bed, they designed the Companion® with a single-point attachment that was removable when not towing. They also designed the Companion to be quiet and smooth when towing.

While competitors take manufacturing to China and Mexico, Joe (Roger retired in 1999) remains committed to using American-made raw materials and American Labor.

“You don’t work for me, you work for the customer. We can compete in this global economy by designing better, using technology, and truly caring about our customers,” Joe affirmed.

Our product line now includes all types of towing products manufactured under the 497,000 sqft. facility. In 2007, Joe began transferring ownership of the company to us, the now 425 employee-owners.





LIKE THE QUALITY OF YOUR COMPANION?

CHECK OUT OUR OTHER PRODUCTS

Request our Product Catalog by calling 800-248-6564 or at www.bwtrailerhitches.com



TOW & STOW®



B&W GEAR
BECAUSE YOU CAN'T
WEAR A TRAILER HITCH



WE'D LOVE TO HEAR FROM YOU!

B&W Trailer Hitches | 1216 Hawaii Road | Humboldt, KS 66748

800.248.6564

Live chat with us on our website
bwtrailerhitches.com

