

⚠ WARNING ⚠

The information in this instruction manual is intended only as a supplement to the Crystal Fire Plus® instruction manual and is not an exhaustive installation manual. If the information in both instruction manuals is not followed exactly, a fire or explosion may result causing property damage, personal, injury or loss of life.



⚠ WARNING ⚠

FOR OUTDOOR USE ONLY.

Installation and service must be performed by a qualified installer, service agency, or the gas supplier.

⚠ WARNING ⚠

The Outdoor GreatRoom Company™, LLC disclaims any responsibility for, and the warranty will be voided by, the following actions:

- Installation and use of any damaged components
- Modification of the burner assembly or included components
- Installation other than detailed in this manual

Any such action may result in a fire or explosion causing property damage, personal injury, or death.



TABLE OF CONTENTS

1. Commercial Controls	3
a. Controls on Appliance.....	3
• 4HRTC - 4-Hour Timer Control Panel	
b. Controls Away from Appliance.....	5
• CFP-ESO-CP - Emergency Stop	
• WSES-CP - ON/OFF Wall Switch and Emergency Stop	
• 4HRTEs-CP - 4-Hour Timer and Emergency Stop	
c. Additional Information.....	11
• CF-DSI-SB - Switch Bypass	
2. Burner Plate Information	13
a. Square Burner Plates	13
b. Round Burner Plates	15
c. Linear Burner Plates	17

1 COMMERCIAL CONTROLS

A. CONTROLS ON APPLIANCE

4HRTC

4-HOUR TIMER CONTROL PANEL

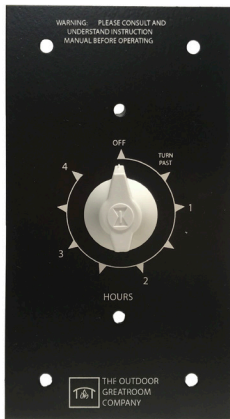

- Installed **on the appliance**.
- Includes 36 in. wire lead that connects directly to CF-DSI.
- Replaces the standard CF-DSI control switch.
- Eliminates remote (CF-DSI-R) functionality.
- Operates **low-voltage** circuit.

INSTALLATION DIAGRAM - (4HRTC)

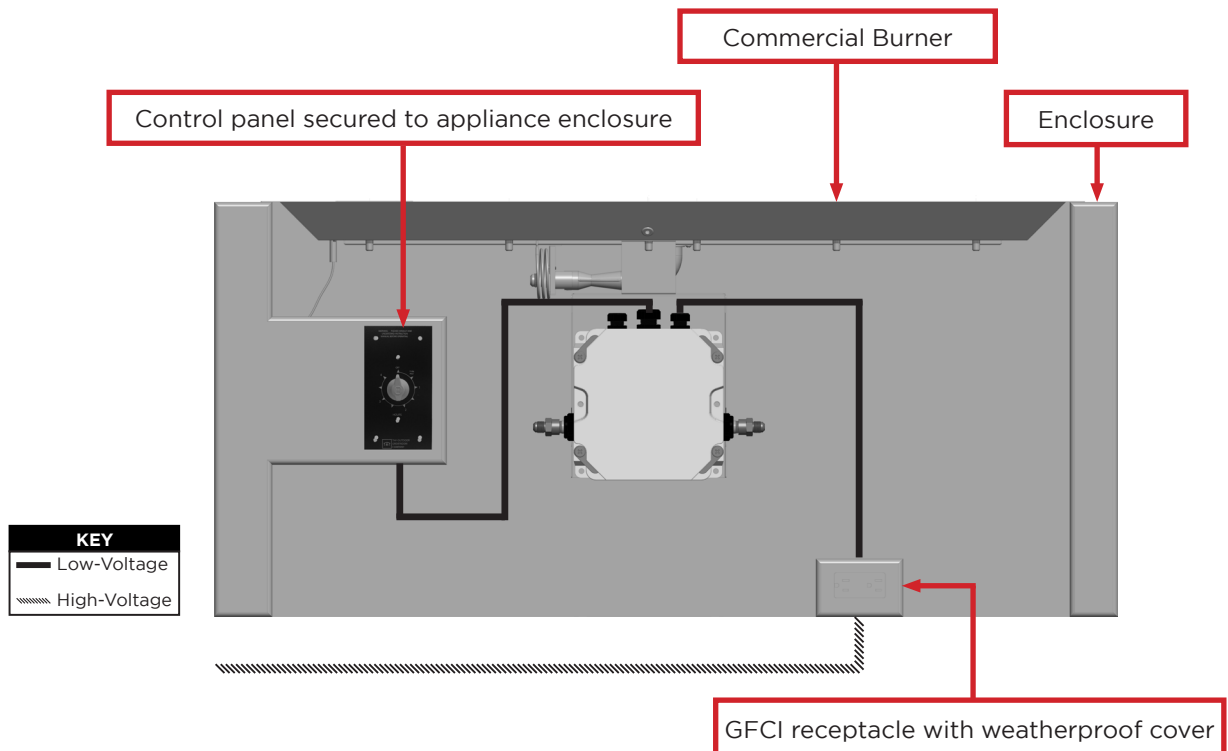



WIRING DIAGRAM - (4HRTC)

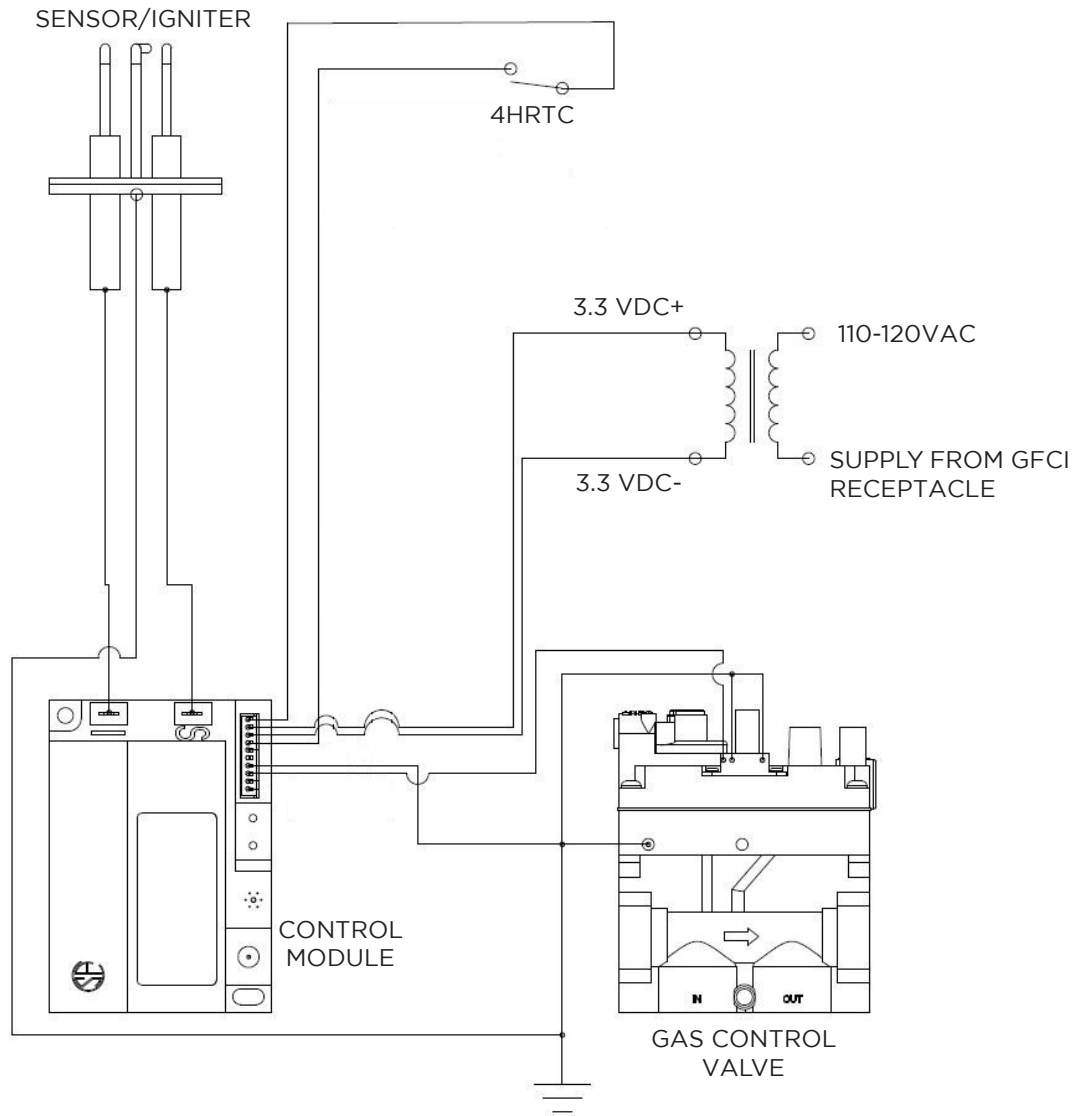

B. CONTROLS AWAY FROM APPLIANCE

CFP-ESO-CP

EMERGENCY STOP



- Installed **away from the appliance**.
- Install on a wall or pillar in accordance with local electrical code.
- Includes printed instruction cover plate.
- Mounts to single-gang junction box.
- Immediately cuts **high-voltage** to the appliance circuit.

INSTALLATION DIAGRAM - (CFP-ESO-CP)

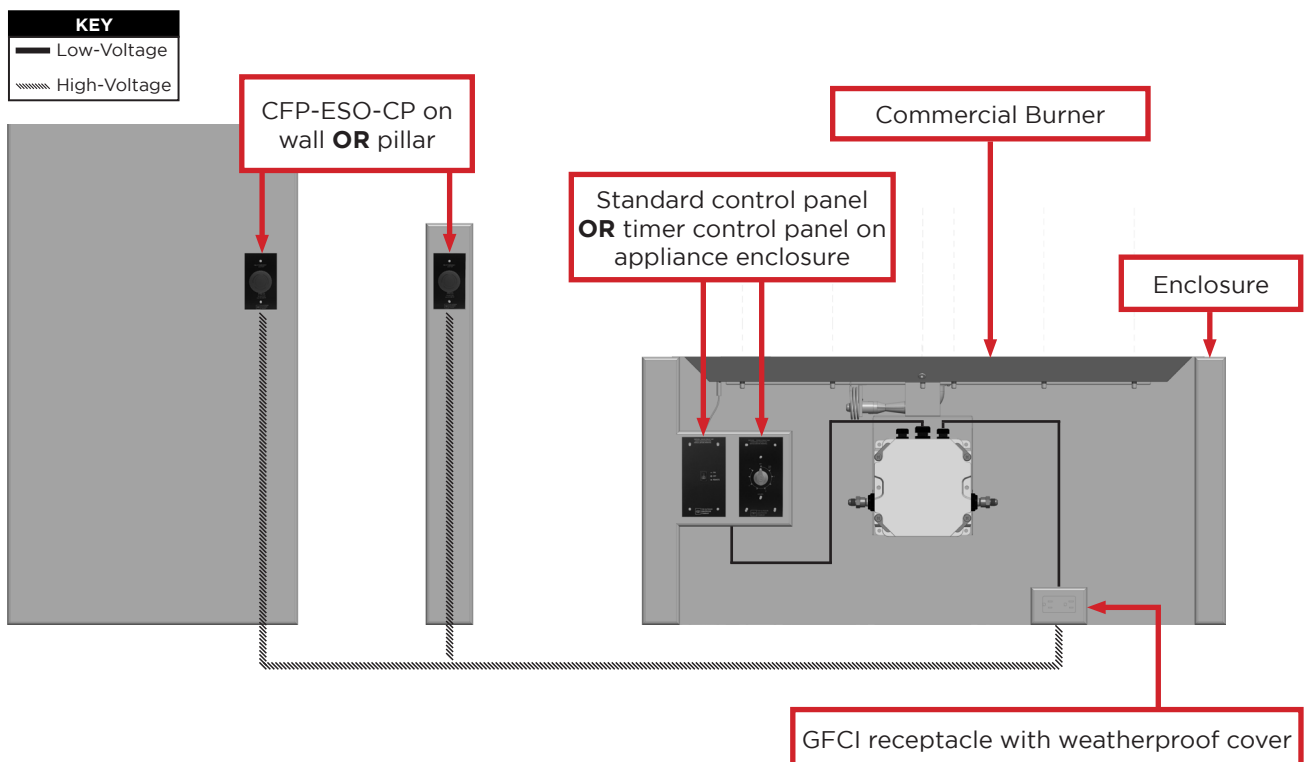



WIRING DIAGRAM - (CFP-ESO-CP)

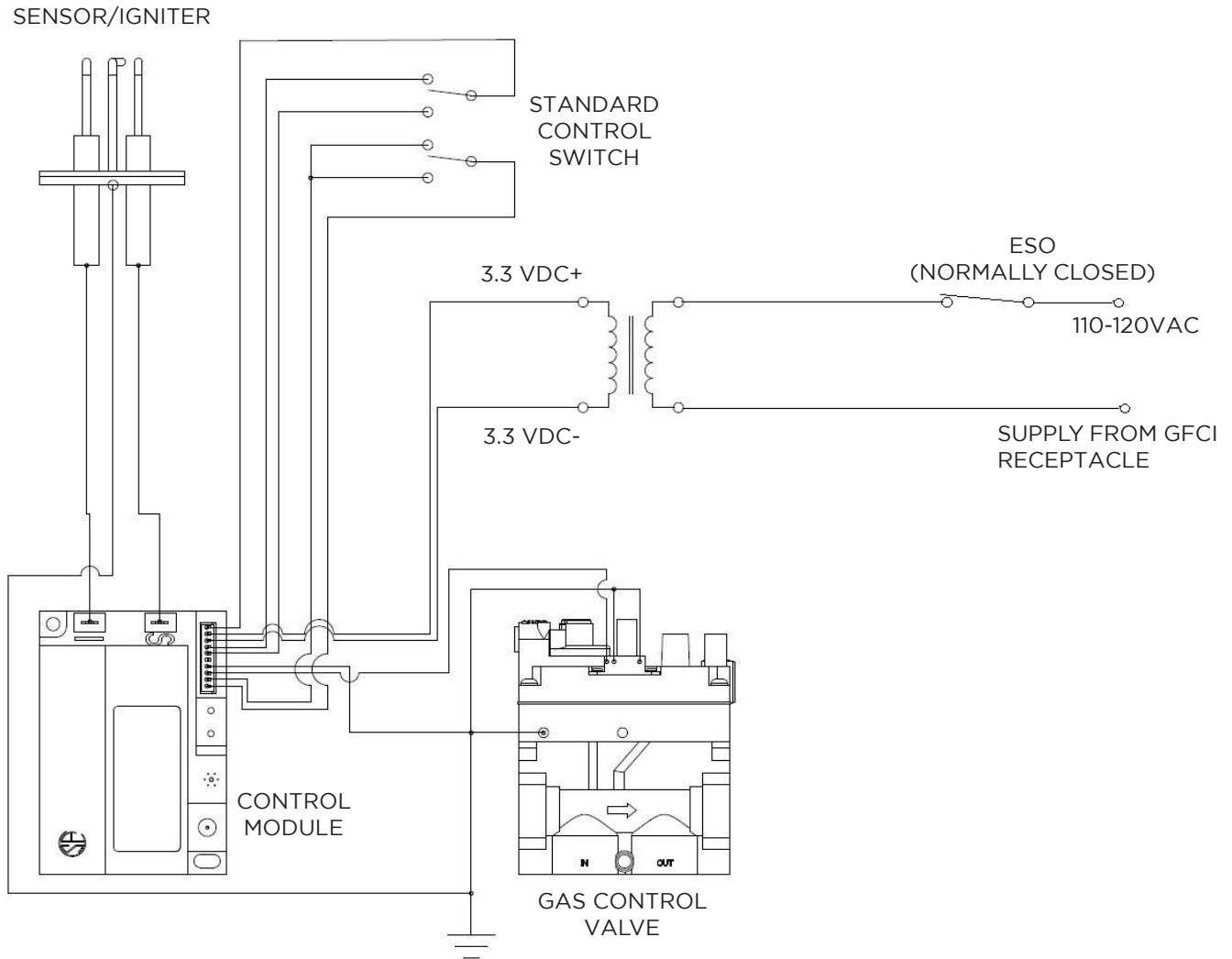

⚠ WARNING ⚠

If any components were damaged during the incident that prompted the use of the emergency stop button, they **must be replaced** before the appliance is operated again. In some instances, the entire appliance should be replaced.

After emergency stop is pressed and situation is resolved, **DO NOT** immediately reset the emergency stop button. Follow these steps to reset:

1. Turn all controls to the OFF position. This includes the CF-DSI switch, the 4-hour timer, and/or the wall switch.
2. Verify that appliance is not covered or obstructed.
3. Reset the emergency stop button by twisting clockwise.

WSES-CP ON/OFF WALL SWITCH AND EMERGENCY STOP



- Installed **away from the appliance**.
- Only install on a wall **within line-of-sight** of the appliance in accordance with local electrical code.
- Includes printed instruction cover plate.
- Mounts to double-gang junction box
- Operates **high-voltage**.
- Included DSI switch bypass (CF-DSI-SB) can be installed on DSI to remove control from appliance and give sole control to the WSES-CP.
- If CF-DSI-SB is installed, remote functionality is removed.

INSTALLATION DIAGRAM - (WSES-CP)

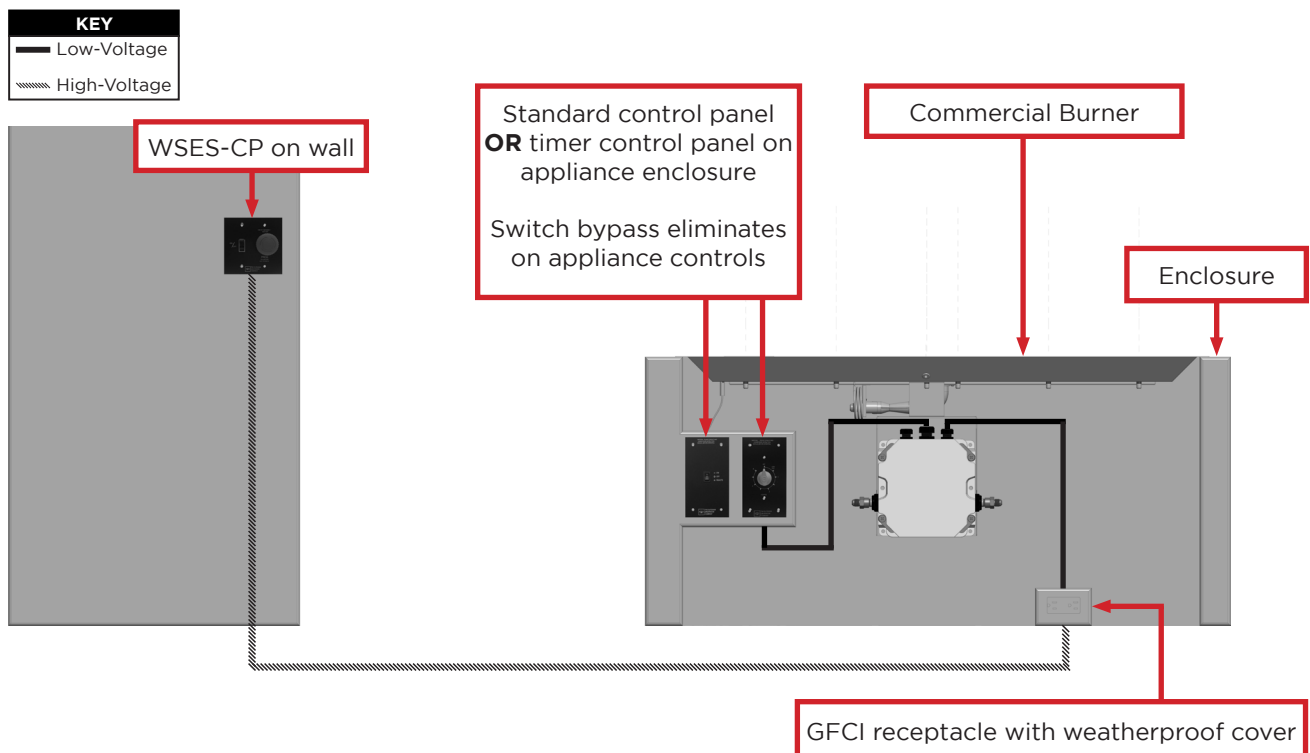



WIRING DIAGRAM - (CFP-ESO-CP)

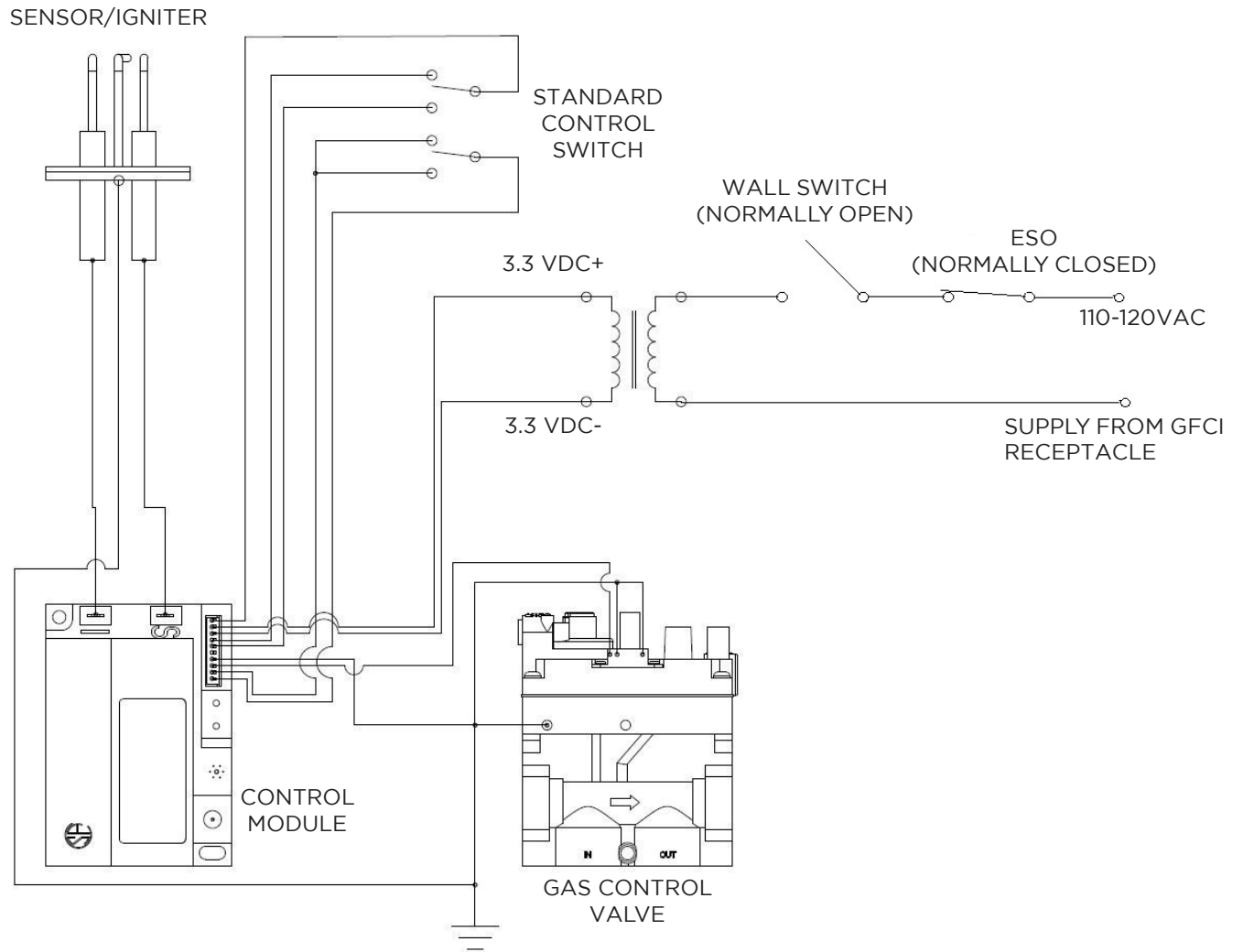

4HRTES-CP

4-HOUR TIMER AND EMERGENCY STOP

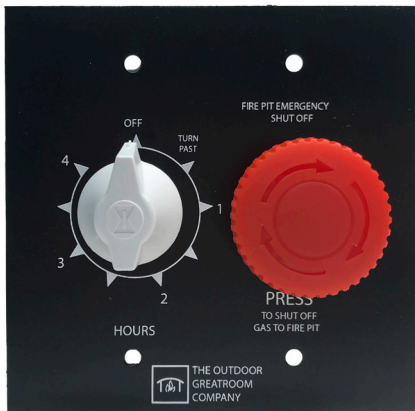

- Installed **away from the appliance**.
- Only install on a wall **within line-of-sight** of the appliance in accordance with local electrical code.
- Includes printed instruction cover plate.
- Mounts to double-gang junction box
- Operates **high-voltage**.
- Included DSI switch bypass (CF-DSI-SB) can be installed on DSI to remove control from appliance and give sole control to the WSES-CP.
- If CF-DSI-SB is installed, remote functionality is removed.

INSTALLATION DIAGRAM - (4HRTES-CP)

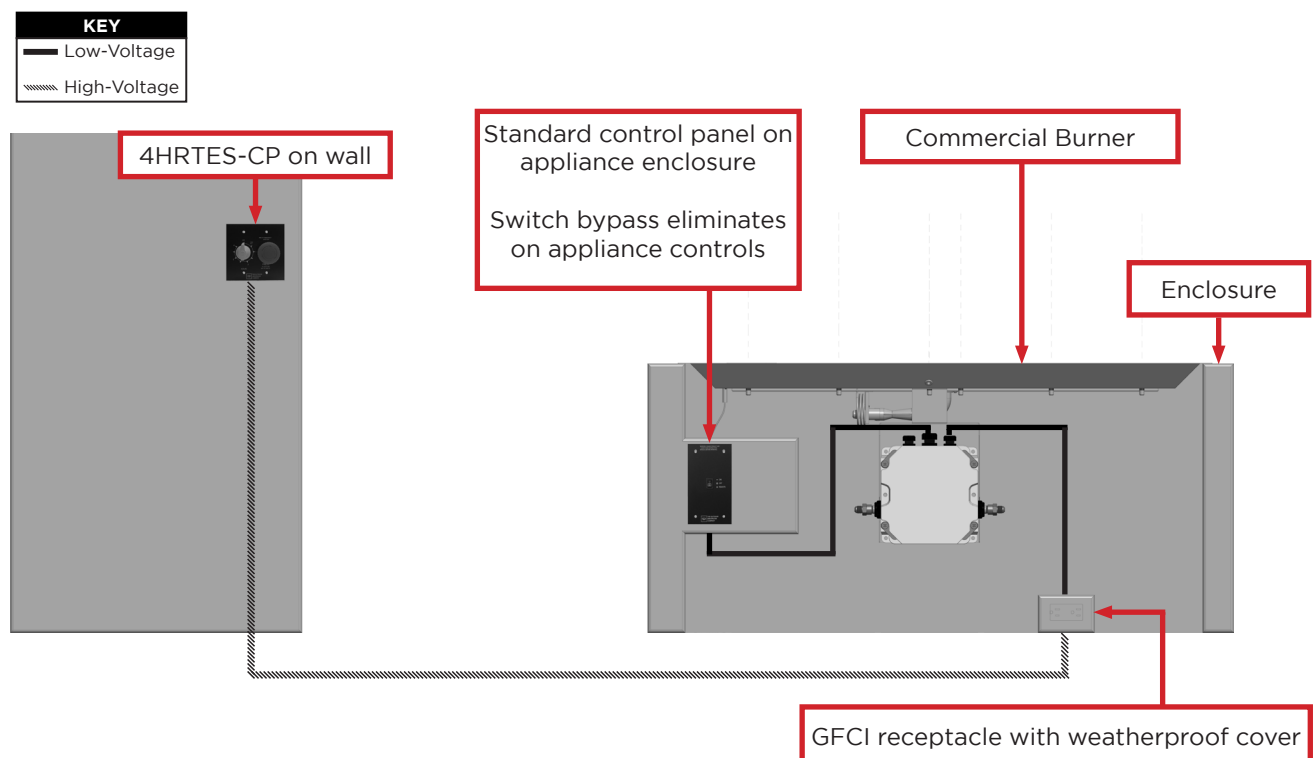



WIRING DIAGRAM - (4HRTES-CP)

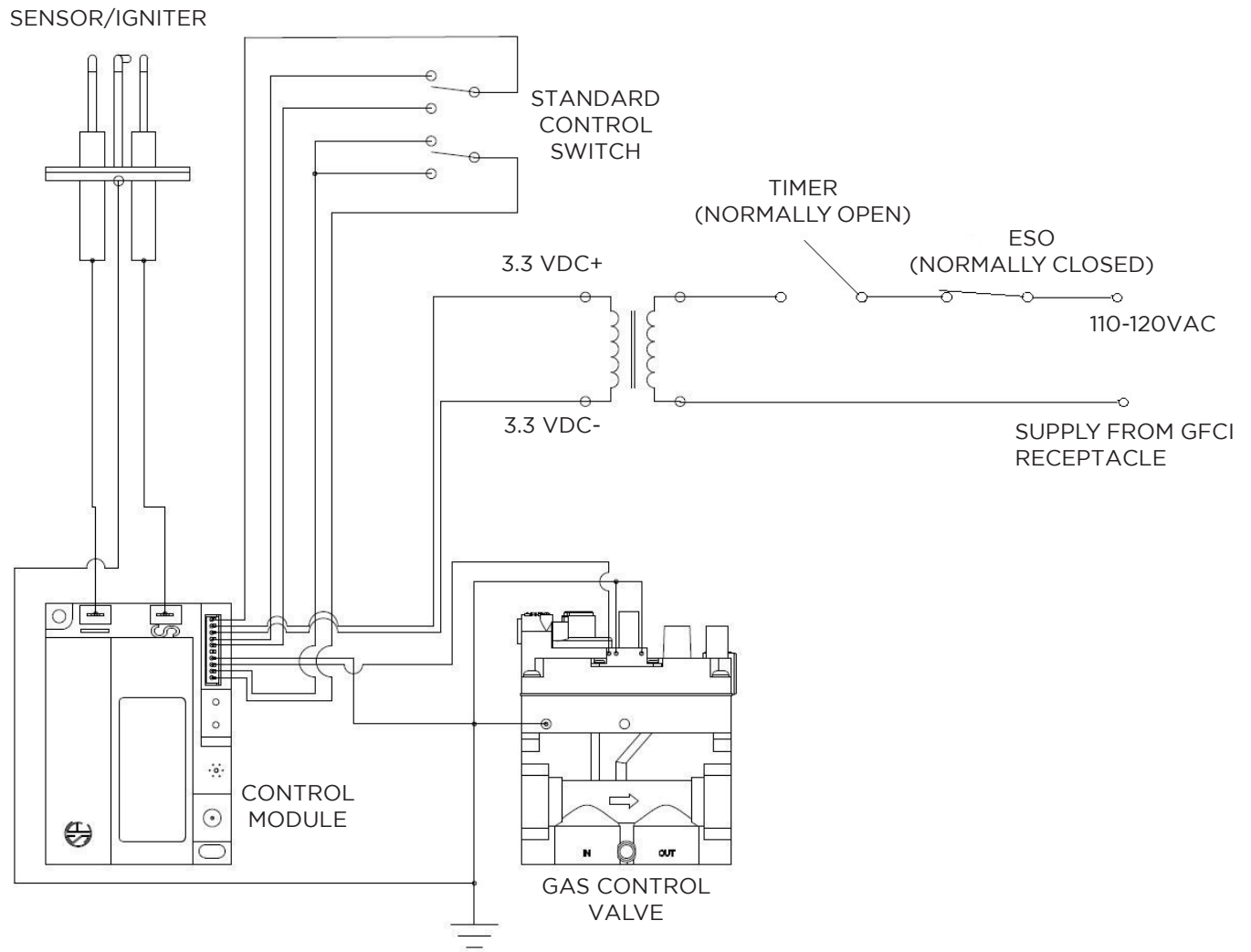

C. ADDITIONAL CONTROL INFORMATION

CF-DSI-SB

SWITCH BYPASS

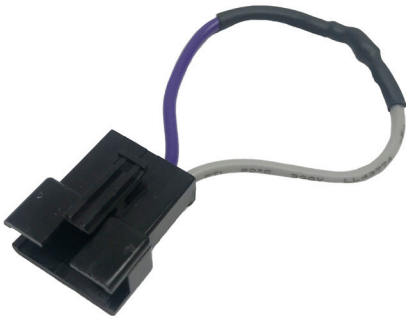

- Installs on CF-DSI where low-voltage control switch would normally connect.
- Removes manual switch and remote functionality from CF-DSI
- Appliance is then controlled **solely by the high-voltage.**

INSTALLATION DIAGRAM - (CF-DSI-SB)

Connect CF-DSI-SB to female 5-pin connector on DSI.

The connectors are keyed and can only connect one direction.

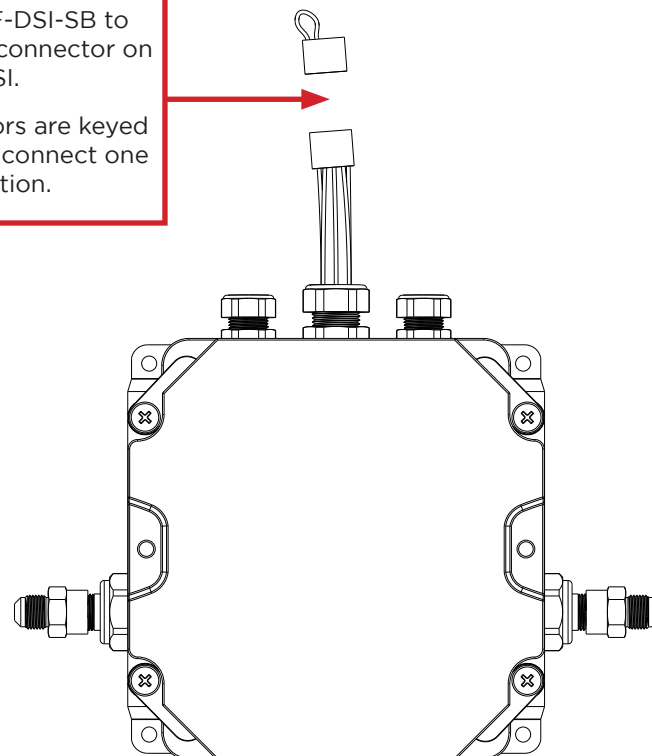



WIRING DIAGRAM - (CF-DSI-SB)

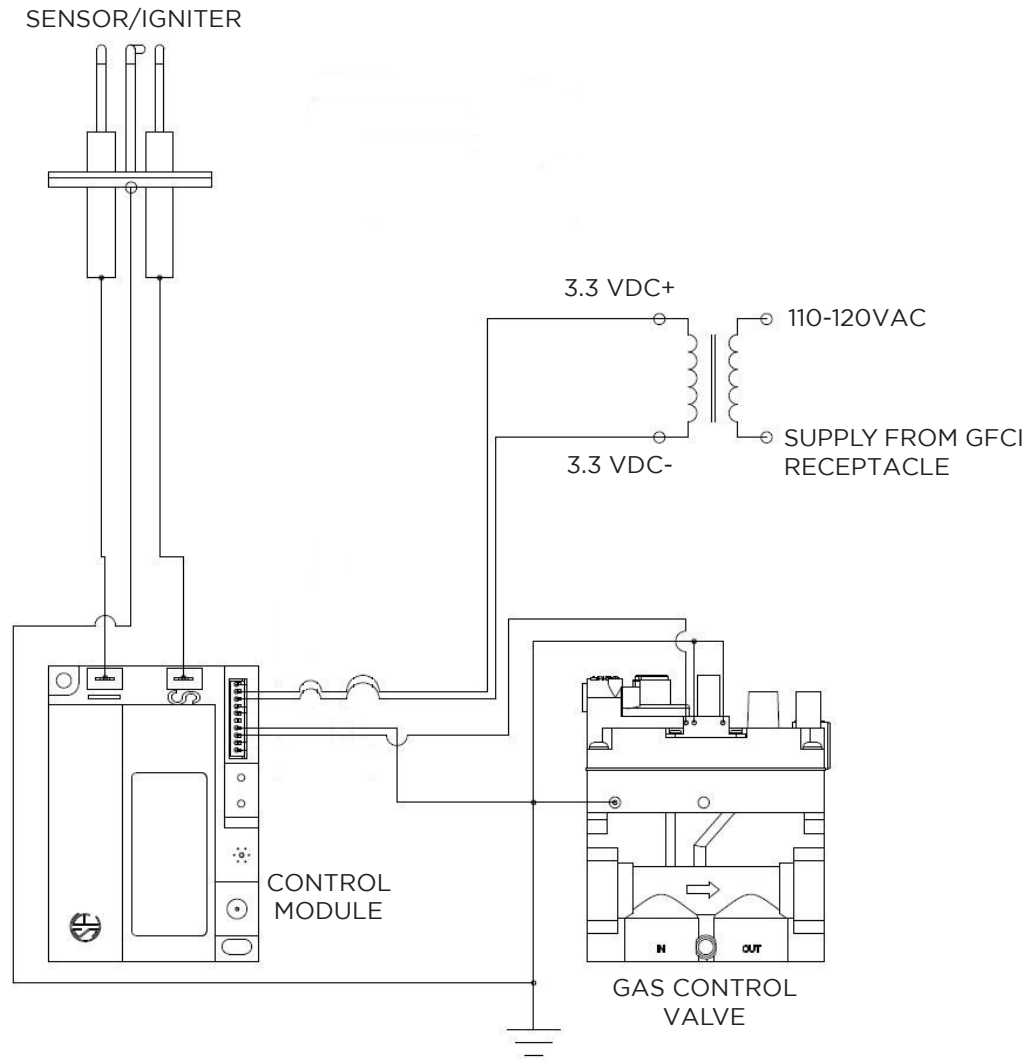

2

BURNER PLATE INFORMATION

A. SQUARE BURNER PLATES

INSTALLATION GUIDELINES

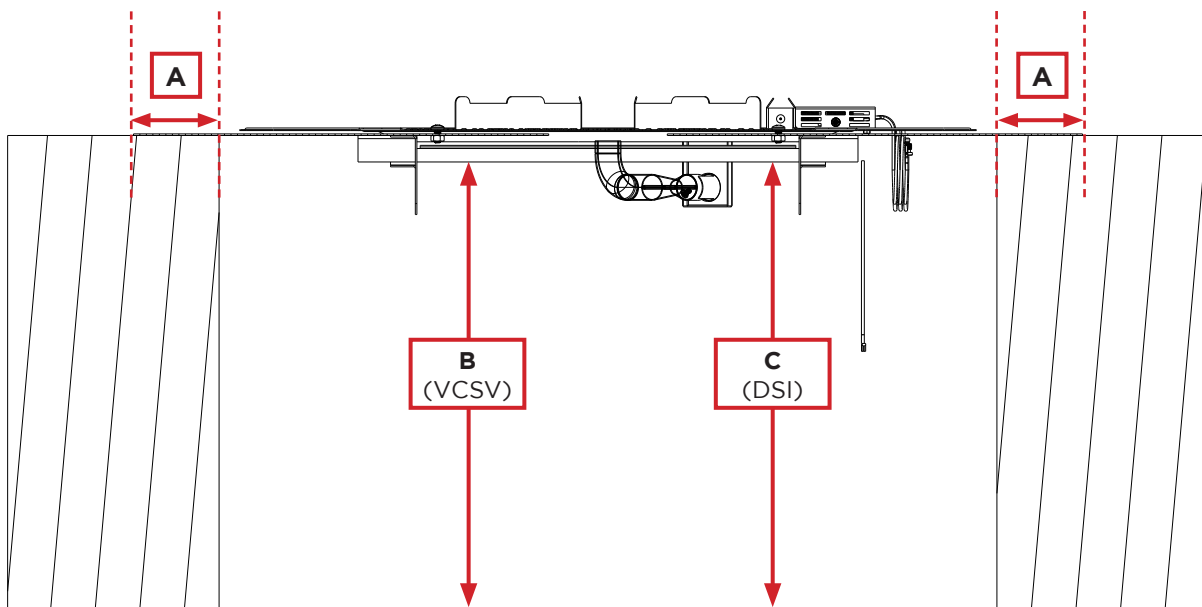

BURNER PLATE MODEL	A		B		C	
	MIN (IN.)	MAX (IN.)	MIN (IN.)	MAX (IN.)	MIN (IN.)	MAX (IN.)
BP24S	1.00	2.50	6.00	N/A	15.00	N/A
BP30S	1.00	5.50	6.00	N/A	15.00	N/A
BP36S	1.00	5.50	6.00	N/A	15.00	N/A
BP42S	1.00	6.00	6.00	N/A	15.00	N/A



INSTALLATION INSTRUCTIONS

1. Ensure enclosure meets requirements detailed in Crystal Fire Plus installation manual.
2. Position and if necessary secure burner plate to enclosure.
3. Install top material or capstone.
4. Burner insert can then be connected to gas and electrical according to the Crystal Fire Plus instruction manual and lowered into the burner plate. Ignition wind guard should be oriented towards cutout in burner plate.
5. For BI28 burners, it is necessary to secure burner insert to burner plate. Remove the four (4) 1/4"-20 x 3/4" machine screws from burner plate threaded inserts and secure BI28 to burner plate through perimeter drainage holes.

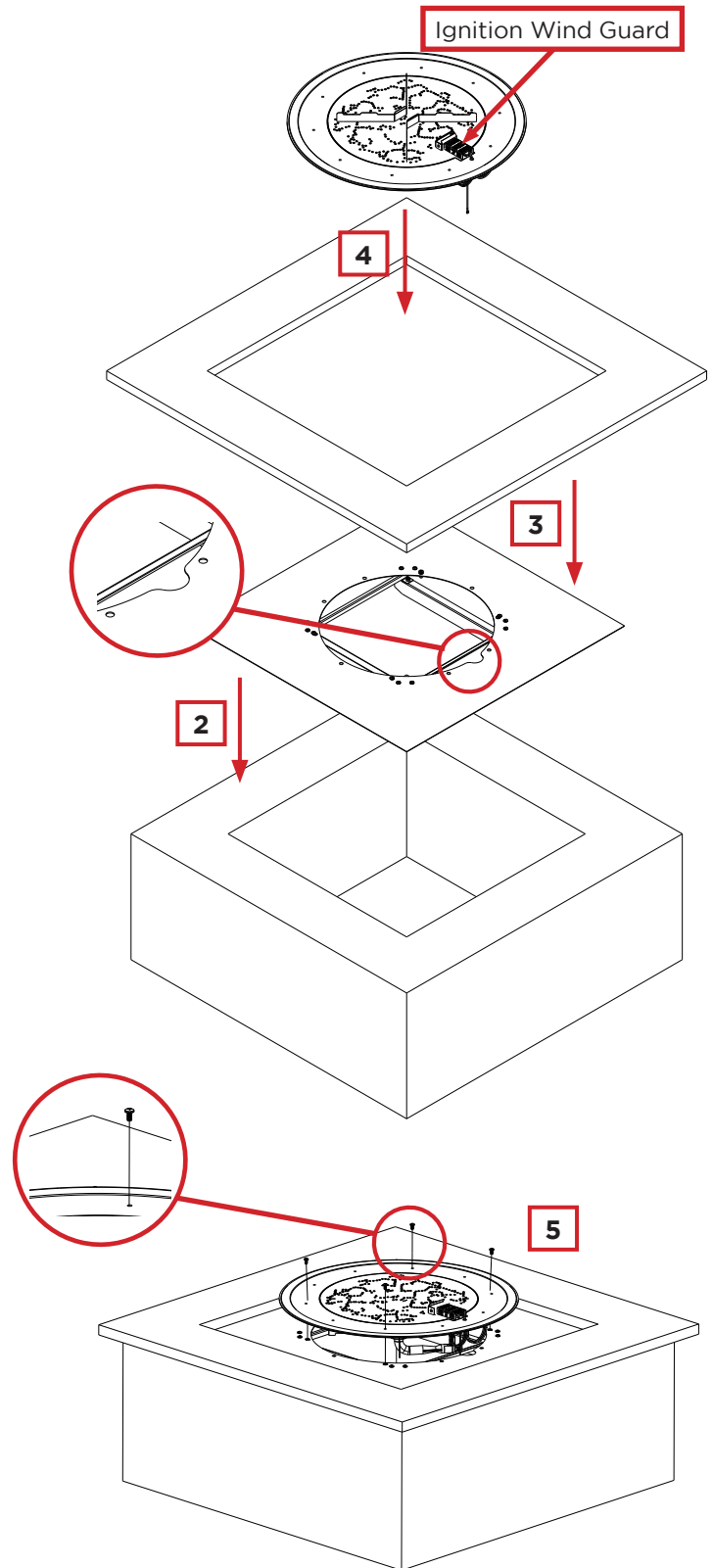

B. ROUND BURNER PLATES

INSTALLATION GUIDELINES

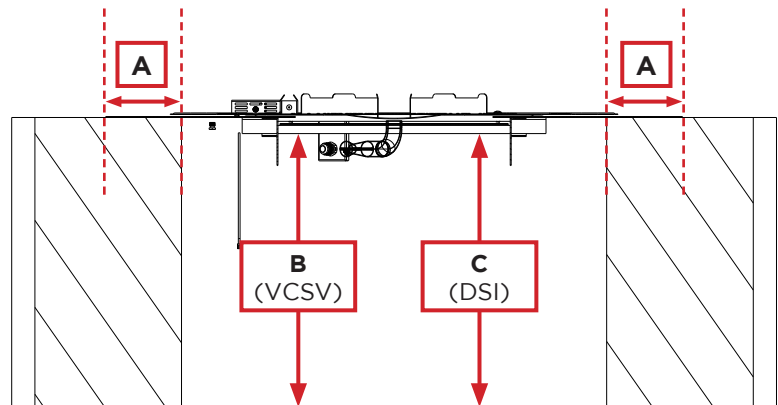
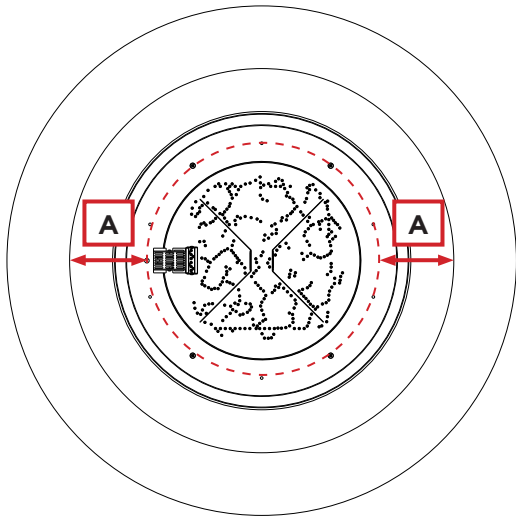

BURNER PLATE MODEL	A		B		C	
	MIN (IN.)	MAX (IN.)	MIN (IN.)	MAX (IN.)	MIN (IN.)	MAX (IN.)
BP20RD	1.00	2.50	6.00	N/A	15.00	N/A
BP24RD	1.00	4.50	6.00	N/A	15.00	N/A
BP30RD	1.00	2.50	6.00	N/A	15.00	N/A
BP36RD	1.00	5.50	6.00	N/A	15.00	N/A
BP42RD	1.00	6.00	6.00	N/A	15.00	N/A
BP48RD	1.00	6.00	6.00	N/A	15.00	N/A

INSTALLATION INSTRUCTIONS

1. Ensure enclosure meets requirements detailed in Crystal Fire Plus installation manual.
2. Position and if necessary secure burner plate to enclosure.
3. Install top material or capstone.
4. Burner insert can then be connected to gas and electrical according to the Crystal Fire Plus instruction manual and lowered into the burner plate. Ignition wind guard should be oriented towards cutout in burner plate.
5. For BI28 burners, it is necessary to secure burner insert to burner plate. Remove the four (4) 1/4"-20 x 3/4" machine screws from burner plate threaded inserts and secure BI28 to burner plate through perimeter drainage holes.

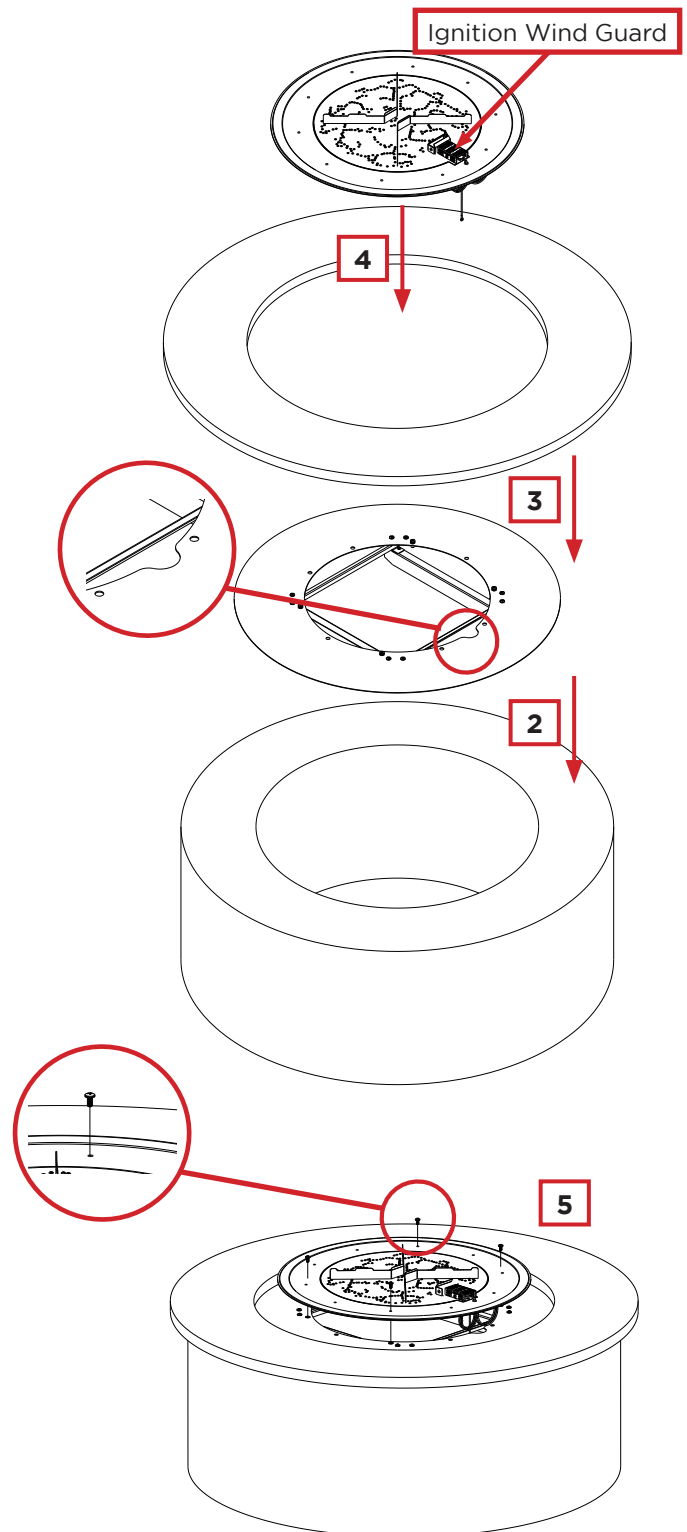

C. LINEAR BURNER PLATES

INSTALLATION GUIDELINES

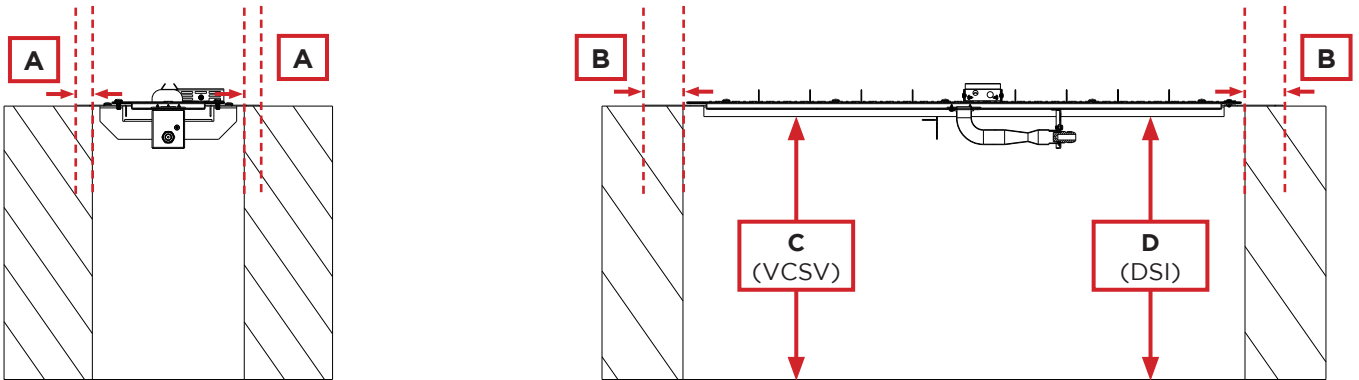

WIDTH OF BURNER PLATE (IN.)	A		B		C		D	
	MIN (IN.)	MAX (IN.)	MIN (IN.)	MAX (IN.)	MIN (IN.)	MAX (IN.)	MIN (IN.)	MAX (IN.)
12	.50	1.50	.50	3.00	15.00	N/A	13.00	N/A
18	.50	2.25	.50	3.00	15.00	N/A	13.00	N/A
24	.50	3.50	.50	3.00	15.00	N/A	13.00	N/A



INSTALLATION INSTRUCTIONS

1. Ensure enclosure meets requirements detailed in Crystal Fire Plus installation manual.
2. For burner plates longer than 64 in., the two halves of the burner insert and burner plate must be secured together with included mending brackets and hardware.
3. Position and if necessary secure burner plate to enclosure.
4. Install top material or capstone.
5. Burner insert can then be connected to gas and electrical according to the Crystal Fire Plus instruction manual and lowered into the burner plate. Thermocouple and igniter lead should pass through indicated hole on burner plates.

**Note: For VCSV units, thermocouple and igniter lead should pass through indicated hole on burner plate.*

