



# Alumabode RooftopTents

## InstallandSetupInstructions

---

# Welcome to the BeneHike! Let's get your rig sorted.



## A Note About Roof Racks

---



•BENEHIKE are engineered to be mounted to two crossbars that are at least 30 inches apart. Platform racks can be used, but are not necessary and in some cases make installation trickier.

Please refer to the [platform rack installation guide](#) for more information.

- On some makes of vehicles, the stock crossbars are too close to the roof to provide the clearance to install the mounting hardware. In these cases an after-market crossbar solution is recommended. Contact Sales with questions.
  - You can always use [etrailer.com](#) as a great resource to find the perfect crossbar or [check out this article for more information](#).
- The BENEHIKE Alumabode, 3 Person weigh 136 lbs, the 4 Person weigh 156lbs. Your crossbars should be rated to support the weight of the tent by itself. Your crossbars have a weight rating which is the dynamic load rating (when your vehicle is moving at highway speeds) and can support 5-7 times this Dynamic Load rating when your car is parked. Almost all modern cars and crossbars have no problem supporting the weight of a BeneHike and occupants - just don't drive on the highway with your friends in your BeneHike

workshop more than 4000 square feet located in Yongkang City-Hardware capital of China. With the advantage of well supporting industries and our attention to camping products development, our products are acclaimed in such markets as Europe, North America, South America, East Asia, Oceania ect. To meetclients' special requirement, we do customization and launch new products on a regular basis to attact more customer to further increase our brand awareness. We won a good business reputation in the global market with stability of our team and "Customer-center" service standard, professional management staff, excellent designers, experienced engineers and high skilled worker are available to provide high quality, costeffective outdoor products.

Welcome to visit our factory and discuss more on our products&designs,establish long term trade relations and strong cooperation with mutual benefits.

**TABLE OF CONTENTS**

1.IMPORTANT INFORMATION.....2

2.WARNINGS AND SAFETY INSTRUCTIONS.....3-4

3.PARTS LIST.....5

4.OPERATING INSTRUCTIONS .....6-7

5.CARE AND MAINTENANCE.....8

6.STORAGE AND HANDLING ( OFF VEHICLE).....9

7.WARRANTY.....10



## IMPORTANT INFORMATION

BENEHIKE® is not liable for damage or accidents resulting from non-observance of the instructions, changes to parts, or the use of parts other than BENEHIKE®'s original parts. The warnings, safety and operating instructions in this manual cannot cover every imaginable situation, so it is the user's responsibility to exercise common sense and caution. It is your responsibility to pass these instructions on to third parties using this rooftop tent, including second-hand sales.

## WARNINGS AND SAFETY INSTRUCTIONS

### ***Rooftop Tent:***

- Before installing the BENEHIKE® rooftop tent, ALWAYS refer to your vehicle and roof rack manuals and ensure that you are following their instructions and advice. It is recommended to carry your vehicle manual, roof rack manual and the user manual of this rooftop tent in your vehicle.
- BENEHIKE® recommends that you should NOT transport your rooftop tent over 100kmh and that you adhere to speed limits.
- With the BENEHIKE® rooftop tent, you should measure the overall height of your vehicle with the tent fitted as you will need this information to decide if the vehicle can enter car parks, etc.
- The attachment of the rooftop tent to your vehicle will alter its centre of gravity. Adjust your driving accordingly.
- At the beginning and at regular intervals during each trip, please check that your tent is firmly installed by ensuring all nuts and bolts and all accessories are safely secured. ALWAYS check your tent is in a safe and appropriate place.
- ONLY open and close the rooftop tent when the vehicle is parked and stationary. ALWAYS ensure the tent is dry prior to closing. If this isn't possible, open immediately when you arrive at your home or next destination. Storing a wet tent can lead to the formation of mold & mildew. It is recommended to store your tent indoors if it's not going to be used for a long time. When storing indoors, be sure to place the tent on a padded surface and away from heavy loads and debris.
- Ensure that the roof rack or roof bars can support the full weight of the rooftop tent while in motion. Ensure the rooftop tent's weight is centred over the middle of the vehicle and its sides are not over hanging the vehicle.
- DO NOT use your rooftop tent if there is any visible damage to any part or its components, instead contact BENEHIKE® to see how we can help.
- Incorrectly mounted roof racks, rooftop tent or cross bars can come loose during travel and cause serious accidents.
- Make sure you give due consideration to the change in your vehicle height and driving behavior (e.g. wind sensitivity, corner and braking behavior) to accommodate the change in vehicle height.







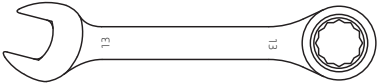

- NEVER force any of the components which could result in damage when opening and closing the tent. Metal components may need to be cleaned with a brush or soft cloth to ensure proper operation.
- DO NOT use cleaning fluids containing bleach, alcohol or ammonia or any other chemicals that would otherwise damage your tent.
- DO NOT drill holes in the ladder. This will weaken the structure of the ladder and can cause injury.
- NEVER leave the tent open for a long time where insects, rodents, or moisture could occur, and regularly inspect your tent for damage and check hardware for signs of rust.
- Keep children away from a stored tent, and ensure it can't be tipped over accidentally.
- Be aware of low entrances, low hanging branches, and other hazards that could damage your roof top tent or vehicle.
- When washing your vehicle, your rooftop tent must be removed first.
- For reasons of fuel economy and the safety of other road users, your roof tent and roof rack should be removed when not in use.
- Keep ALL flame and heat sources away from the tent. Under NO circumstance should ANY naked flame sources or heating devices be used inside the tent.
- Keep a look out for ANY airborne burning embers that may come into contact with the tent. Keep a fire extinguisher or water bucket nearby.
- DO NOT smoke within the tent.
- Keep EXIT clear.

### ***Telescopic Ladder:***

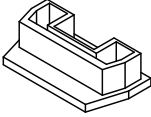
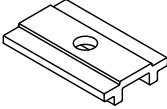
- Make sure that each section is pulled up to its full extension and is locked before continuing to the next section. Improper locking will lead to bodily injuries.
- NEVER open the ladder from the top unless extending to its maximum length.
- NEVER exceed the permissible load capacity of the telescopic ladder. The telescopic ladder has a permissible load capacity of MAX. 150 kg.
- ALWAYS face the ladder during use.
- Wear non-slip footwear when using the ladder.
- Use both hands to grip the ladder when ascending and descending.
- DO NOT attempt to extend or retract the ladder while climbing or standing on it.
- Place body weight in the middle of the rung to ensure stability.
- Equipment carried while using a ladder should be light and easy to handle.
- DO NOT use the ladder as a bridge.
- DO NOT use the ladder in windy environments

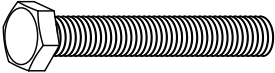
- Check before every use the proper function of the locking mechanisms. If the locking mechanisms are not working properly, DO NOT use the ladder.
- Before using the ladder all the extended rung sections must be locked.
- DO NOT use the telescopic ladder under the influence of pharmaceuticals, drugs, alcohol, etc. or if you feel unwell.
- Remove dirt on the telescopic ladder, such as wet paint, oil or snow before use.
- DO NOT use the telescopic ladder upside down.
- The telescopic ladder is ONLY to be used by one person at a time.
- Avoid leaving an unsecured ladder at the top.
- Avoid excessive lateral loads, such as carrying up heavy loads or drilling sideways in solid materials
- DO NOT spend long periods without regular breaks on the telescopic ladder. Fatigue and loss of balance are accident hazards.
- ALWAYS stand with both feet on one rung.
- When climbing in and out of your rooftop tent, ALWAYS use the ladder with caution and NEVER let children use it unsupervised. Make sure the ladder hooks are in good condition.

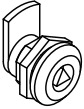
**PARTS LIST**

Item	Description	Qty	
1	Metric Wrench 10/13 mm	2	
2	φ5 inner hexagonal spanner	2	
3	Track plug	4	
4	Aluminum Slide Plate	8	
5	Stainless Steel Mounting Plate	4	
6	55mm Stainless Steel M8 Bolt	8	
7	M8 Self-Locking Nut	8	
8	cam lock	2	
9	Rainfly Poles	4	

# 3 PERSON SPEC

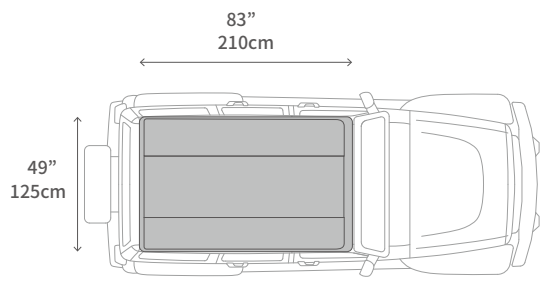
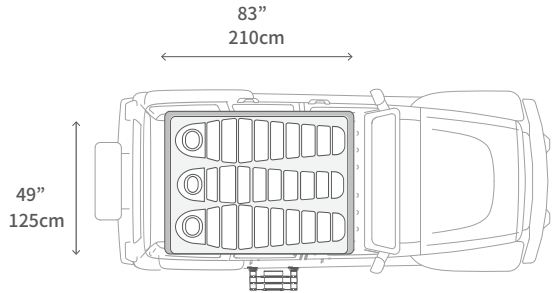
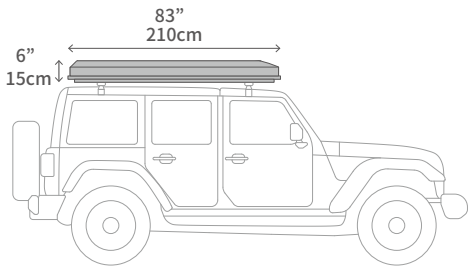
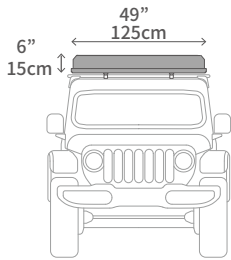

- Weight 136lb, 62kg
- Capacity 1000lb, 454kg
- Ladder Capacity 330lb, 150kg
- Speed Limit 70mph, 110km/h
- Wind Rating 23mph, 10m/s, 20knots
- Hardshell Double layered ABS
- Rainfly Poly 420D PU Coated
- Inner Tent 600D Oxford, 280gsm Poly Cotton Canvas
- Floor Reinforced Aluminum Tube Plate

\*Actual measurements between individual products may vary.



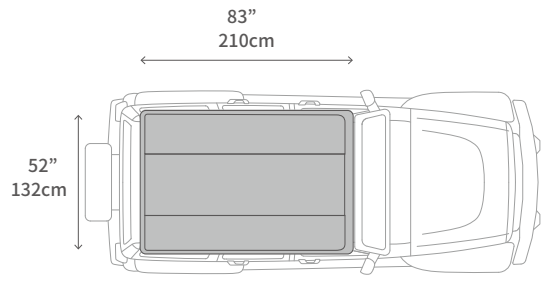
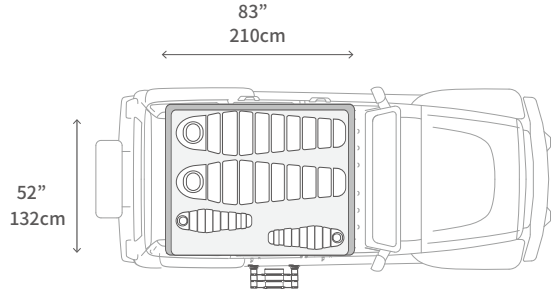
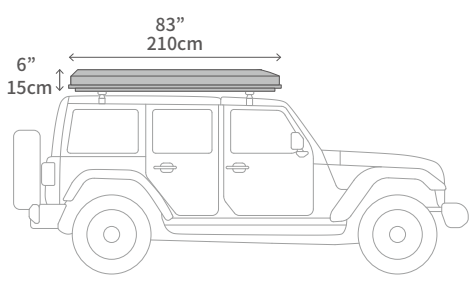
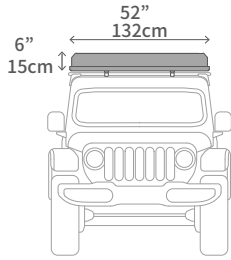

- Weight 165lb, 75kg
- Capacity 1000lb, 454kg
- Ladder Capacity 330lb, 150kg
- Speed Limit 70mph, 110km/h
- Wind Rating 23mph, 10m/s, 20knots
- Hardshell Double layered ABS
- Rainfly Poly 420D PU Coated
- Inner Tent 600D Oxford, 280gsm Poly Cotton Canvas
- Floor Reinforced Aluminum Tube Plate

\*Actual measurements between individual products may vary.

## Crossbar Adjustment

(Not included)

- 1 Before installing the Alumabode, adjust the distance between the roof rack or crossbars.
- 2 Make sure that the roof rack or crossbars are securely fastened.

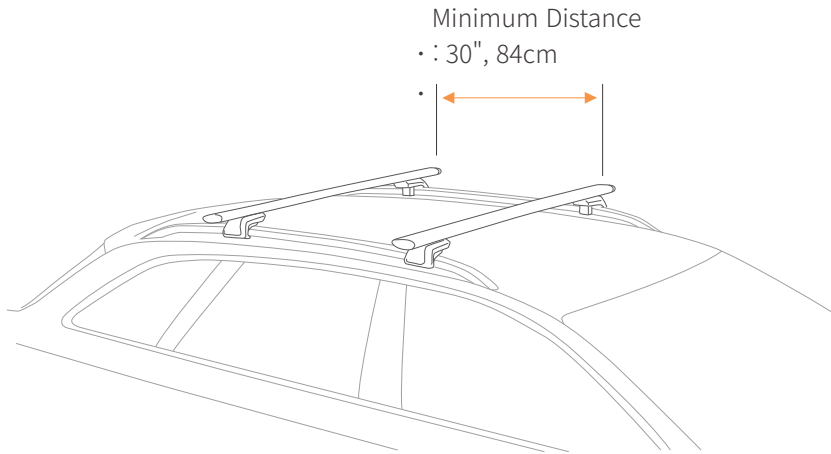

## Mounting

- 1 Lift up vertically at least 4 points of the hardshell.  
(If you don't have special equipment such as a lift, work with several adults.)
  - 2 Make sure the Bivvy is centered.
- ⚠ Caution : Be careful not to press the hardshell when using the lift.

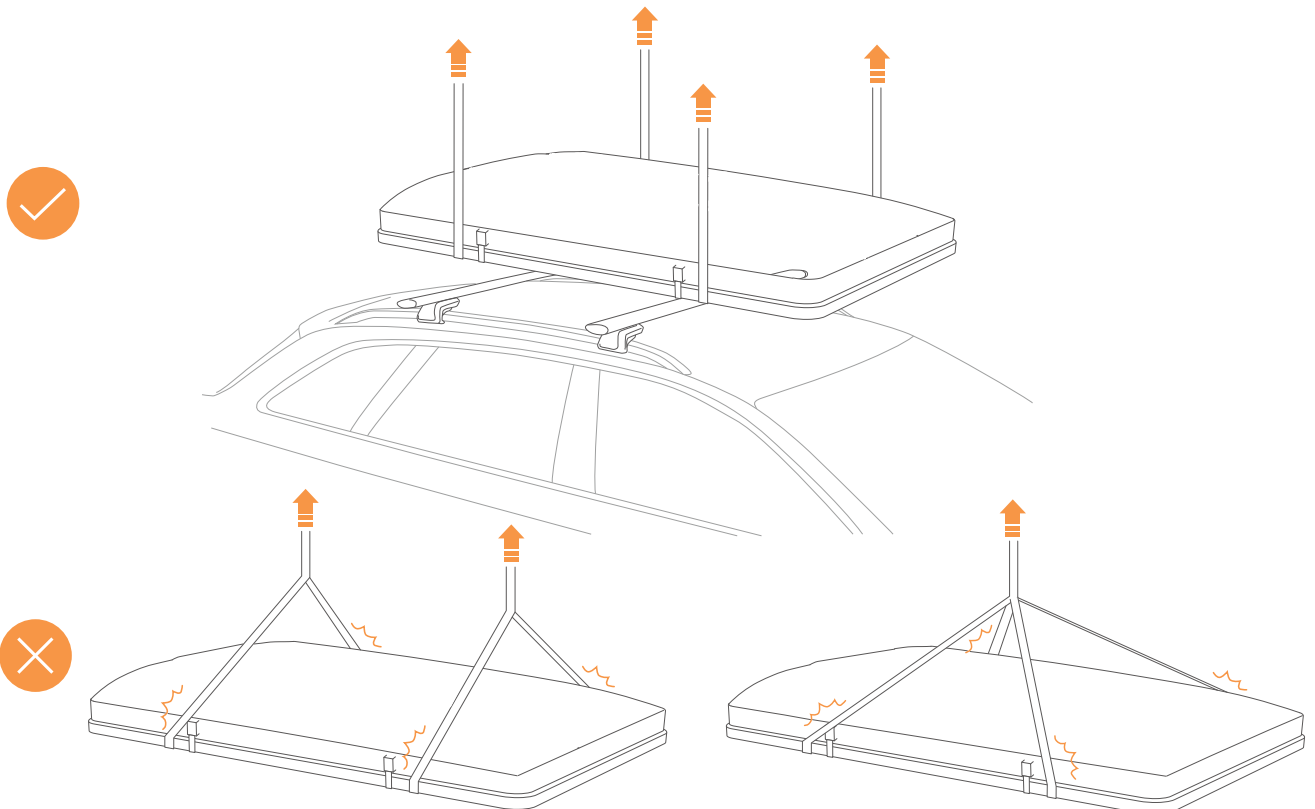

## OPERATING INSTRUCTIONS

### ***FITTING TO THE ROOF RACK OR CROSSBAR:***

1. With assistance, carefully lift your rooftop tent and place it onto the top of the roof racks or crossbars of your vehicle and ensure that the mounting channels are perpendicular to the racks or bars they will be mounted to, and that the tent is centered on the roof rack.



2. Slide the bolts and channel sliders into the mounting channels. You will need to lift your rooftop tent side, so as to have one of the bolts on the inside of the roof rack. Repeat the same steps for the remaining three sides.



3. Use a steel mounting plate and nuts to secure the bolts at each of the four corners where the rack and mounting channel cross. Tighten all eight bolts securely. It is important that you check all the mounting bolts and brackets periodically to ensure they are securely fastened to your base and roof rack or crossbars. Insert the rubber end caps into the ends of the mounting channel (this may require light taps from a hammer) after ensuring the tent is positioned correctly, and all eight bolts are tightened securely.



## OPERATING INSTRUCTIONS

### SET UP YOUR ROOFTOP TENT & LADDER OPERATION

- 1 . Unlock the fastening buckle and release the roof.
- 2 . With your hand push up the hard shell, just give the tent a light push, then the gas struts will open the rest of the tent on its own.
- 3 . Once the top has fully opened, reach up and grab the base of the ladder. Undo the velcro strap and extend the ladder. When opening the ladder, withdraw all rungs and open each rung from the bottom to the top, each rung must be locked. If the ladder is too long, you can push the top few rungs up until they are locked into place.
- 4 . Place the ladder at an approximate 70° angle, and make sure the base of the ladder is level and on solid terrain. If not in a secure place move your vehicle to a more even terrain. The ladder should NOT be over-extended. It will not give the support that it needs to if not set up properly.

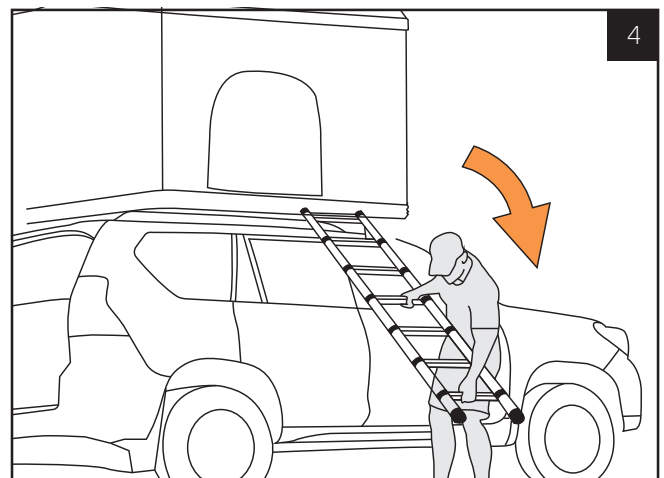
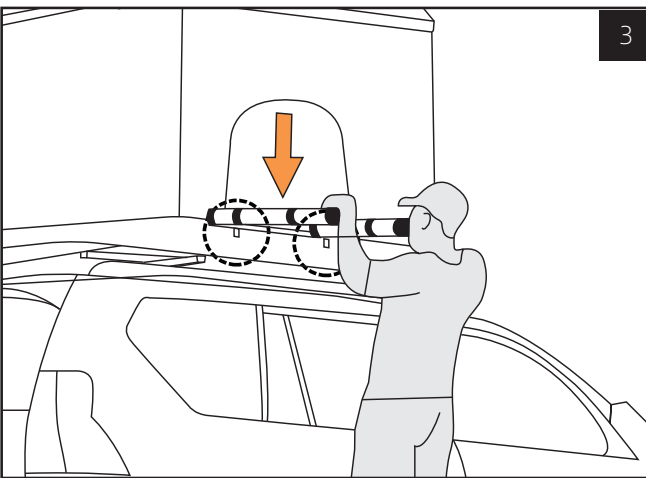
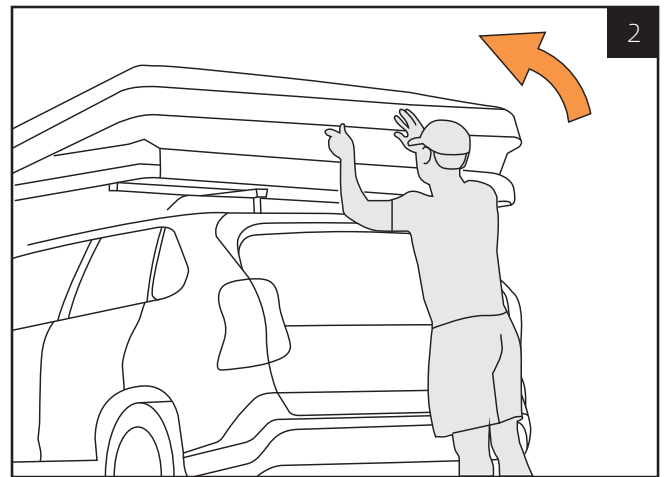
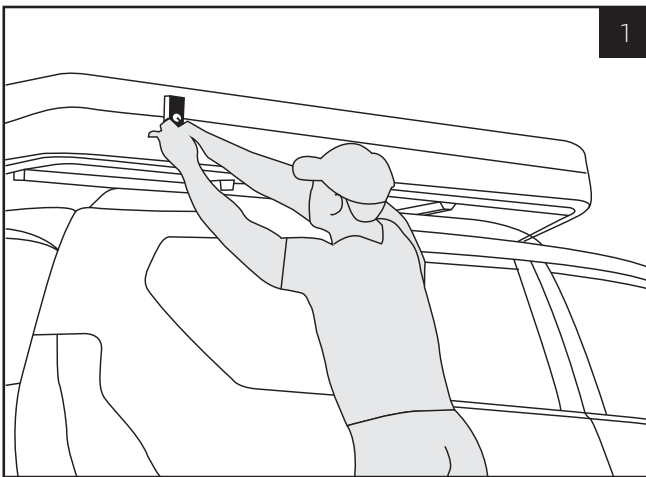

## SETTING UP THE RAIN FLY

The rainfly should be erected using the window rods. Climb half-way up the ladder, take one rod, and insert the straight end into one of the holes located at the bottom of the tent. The hook at the top end of the rod should be facing down.

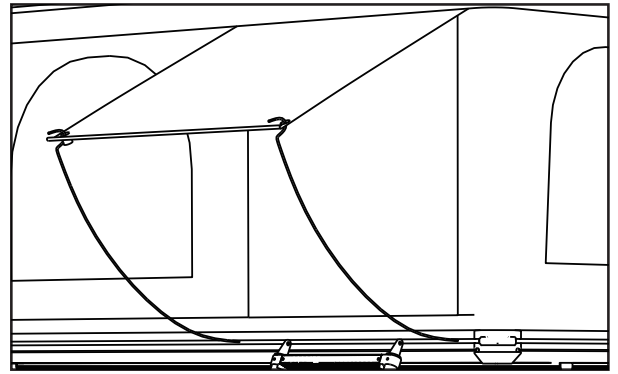

## CLOSING THE ROOF TENT

1. Remove rainfly rods from the canopy. Retract the ladder, starting with the bottom steps. Make sure to depress the buttons with your thumbs and be careful not to get your hand caught between rungs. Then secure the ladder with included strap.
2. Using the ladder, push the tent base up and then push both the base and the ladder into the tent.
3. Grab the black strap attached to the top of the shell. Pull down on the strap to close the hard shell.
4. Gently push in the excess material into the tent on the front, back and side. Then secure your tent.

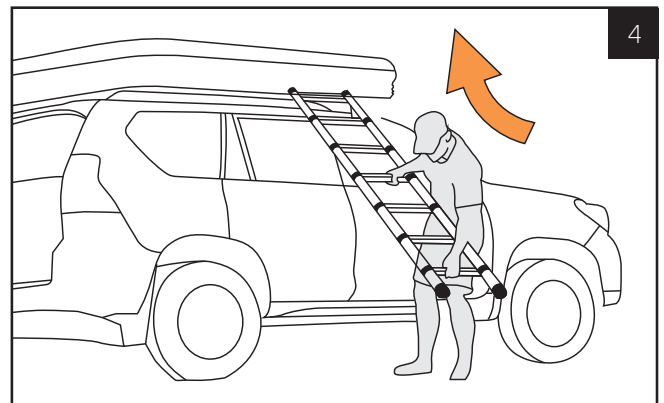
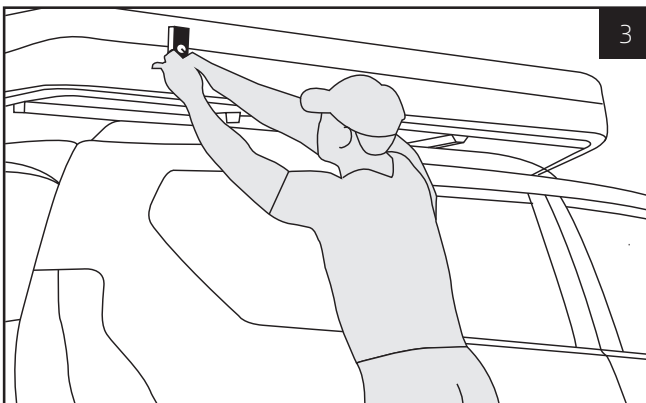
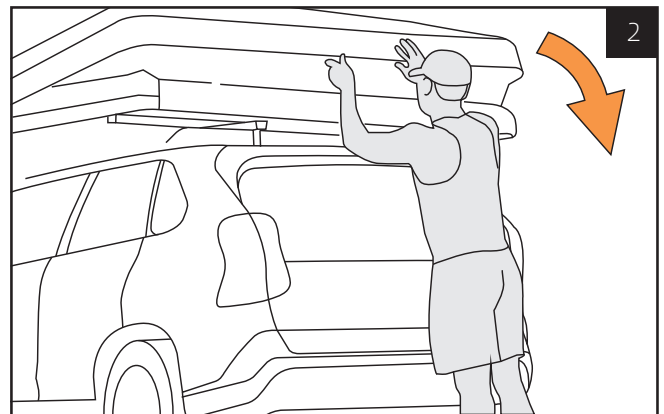
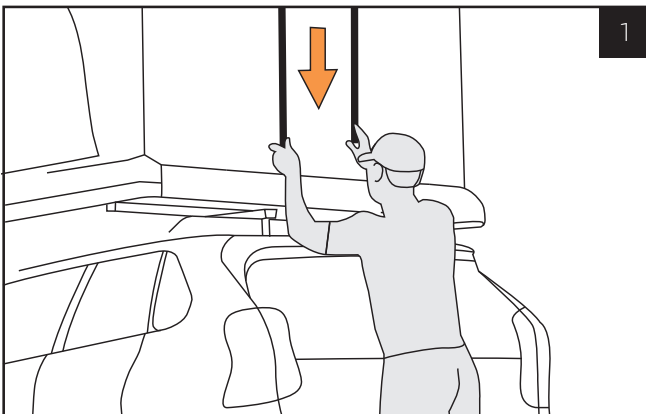

**NOTE:** ALWAYS make sure that the hard shell is completely closed and the straps are securely fastened before driving. If you find it hard to completely close the tent, it may be due to left over canopy.

## CARE AND MAINTENANCE

The BENEHIKE® rooftop tent is designed to be a reliable companion on your adventures. In order to keep it performing at its best, Happy King recommends some care and maintenance steps that will help prolong its life. Prior to each use, inspect your rooftop tent mounting hardware. If necessary, clean with wet cloth. Dry your rooftop tent thoroughly before you close it. If unable to properly dry your rooftop tent prior to closing, open it up and air dry it at your next opportunity. Failure to properly dry your tent out can lead to the growth of mold and mildew which can degrade the tent material, cause discoloration, and foul odor. Mold and mildew growth is not covered under your rooftop tent warranty. To clean your rooftop tent use with cold water and a sponge. DO NOT use soap or detergent. Rinse with a clean wet sponge and allow to thoroughly dry. DO NOT expose to petrol, oil or solvents.

## STORAGE AND HANDLING

Ensure it is fully dry prior to storage and store in a cool dry location free from sunlight. Zippers should be pulled with even force and in a gentle manner. Keep your zippers free from dust and dirt and periodically apply non-scented bees wax to the zipper teeth as lubrication. This will prolong the life of your zippers. Ladder should be wiped free of any dirt or dust prior to collapsing the tent. Keep your mattress dry and free from dirt. Prior to closing your rooftop tent lift your mattress and ensure the underside is dry. Remove mattress and air dry if necessary. To clean mattress cover, remove cover and machine wash gentle cycle. Hang dry, DO NOT TUMBLE DRY. You should ALWAYS wipe your ladder free of any dust or dirt prior to collapsing it for storage. Failure to do so can result in debris contacting your tent which can lead to damage to your tent fabric.

## WARRANTY

BENEHIKE® (“Manufacturer”) warrants, to the original purchaser (“User”) that its rooftop tent, if purchased from manufacturer or an authorized distributor or dealer, will be free of defects in material and/or workmanship under normal usage from the date sold and for the duration (the “Warranty Period”) of 2 YEARS. This warranty shall ONLY be effective for the original purchaser and apply ONLY to the BENEHIKE® rooftop tent that is correctly installed on the vehicle for which it is intended. BENEHIKE® will either replace the product or provide you with a refund at our discretion provided that the fault is found to have been caused by a design or manufacturing defect that results in its failure to perform correctly as described. The limited warranty is the only one that applies to this product, and it sets forth all the responsibilities of BENEHIKE®

## EXCLUSIONS

This warranty does not cover defects, failure or damage caused by incorrect installation, intentional damage, misuse or abuse. It is recommended that the installation should be performed by suitably qualified technicians or the warranty will be voided. For further clarity, this warranty is also void if the rooftop tent: is repaired, altered or modified carried out by anyone other than BENEHIKE®, or without BENEHIKE®'s authorization, is damaged by mold and mildew as the tent is not properly dried prior to closing, is damaged by extreme weather (e.g. storm, hail or strong wind), extreme temperature, accidents, negligence, daily wear and tear, incorrect setup, or failure to check the condition of tent before each use, is damaged by UV degradation or acid rain to the tent/awning and its components, is damaged from improper storage, or a failure to provide routine maintenance, is used on permanent sites or commercial displays.

## CLAIMS

If a BENEHIKE® product is suspected of being defective, you'll need to provide proof of purchase (e.g. a screenshot of the order) and a picture and a video of the damaged goods in their entirety to [service@benehike.com](mailto:service@benehike.com) or +1 (951) 691-3943. If the product is found to be defective and covered by this limited warranty, the remedy is replacement or refund, at BENEHIKE®'s option. No charges will be accepted for external labour or materials.