

# Aero Formula Introduction



# Filling the Future with Our Technology

"The future that fills everywhere with clean air by AEREA's technology."

## CALAB BRAND

---

A E R E A  
The Cleanset Tech

AEREA is air quality specialized product brand with CALAB's independent technology to realize the society that anyone can breathe clean air.

# ✓ AEREA

## Check Point

---



### Respond all harmful substances

Ventilation & purification compound product  
Fine dust as well as Radon  
Respond all the indoor/outdoor harmful substances



### Own technology

2 own technologies, 14 intellectual properties  
Independent filter design and air prediction  
simulation tech through air quality specialized  
research/development



### Publicity

Solve social problems including  
Not only fine dust and viruses  
But also New renewable energy



### Economy

Having a wide marketability  
Its outstanding air quality improvement function  
And economic product



### Convenience

It reflects the design factor of user  
Anyone can use it easily and conveniently



### Safety

Domestic production principles  
And certification for all function  
Safety top priority

# Aero Fomular is developed for these people

Who wants to breathe clean air inside a car

Who wants to block ultra fine dust completely

Who wants to have longer lifespan and economic product

Who want to have better performance than vehicle purifier

# Ultra fine dust increase the risk of disease & death

## Issue of ultra fine dust seriousness

### Exposure of ultra fine dust increases the risk of myocardial infarction

주요지 기자 | © 입력 2021.01.27 06:07 | 수정 2021.01.27 10:05 | 댓글 1

**대기오염은 건강 위협하는 환경 문제... 연간 420만명 사망  
3가지 연구에서 초미세먼지는 질병·사망 위험 증가시켜  
WHO "대기오염 줄이는 정책·투자 절실"**

[메디칼업저버 주요지 기자] 최근 발표된 3가지 연구에 따르면 초미세먼지에 노출되면 시력 상실 위험이 높아지고, 심근경색과 만성신장질환 발생 위험까지 증가되는 것으로 나타났다.

대기오염은 건강을 위협하는 가장 중요한 환경 위험이다. 초미세먼지 노출은 사망률·이환율 증가와 연관됐으며 폐·심혈관질환 및 녹내장 등 다양한 질환과 연관됐다.

세계보건기구(WHO)는 대기오염이 뇌졸중, 심장질환, 폐암, 호흡기질환을 일으키고 이로 인해 연간 약 420만명이 사망한다고 밝혔다.



사진 출처: 포토펙크닷컴

인터넷 뉴스 보도자료(MEDICAL Observer, 2021.01.27)

### what you drink everyday, increases the risk of dementia

이해나 헬스조선 기자

입력 2022.01.05 07:00



대기 오염이 치매 발생에 영향을 미친다는 연구 결과가 나왔다./사진=클립아트코리아

매일 마시는 공기가 '치매' 발병에 영향을 미칠 수 있다는 내용의 연구 결과가 나왔다.

미국 서던 캘리포니아대 다이아나 유난 교수팀은 2008~2016년 사이 매 1년마다 74~92세 미국 여성 2239명의 뇌 기능을 평가했다. 연구 참여자들은 모두 치매 진단을 받은 적이 없는 사람들이었는데, 연구 기간 동안 398명(18%)이 치매에 걸렸다.

인터넷 뉴스 보도자료(헬스조선, 2022.01.05)

Ultra fine dust couldn't be filtrated by nose/mouth/organ and occurs diseases by accumulating in the body

## Absorbed dust size in body

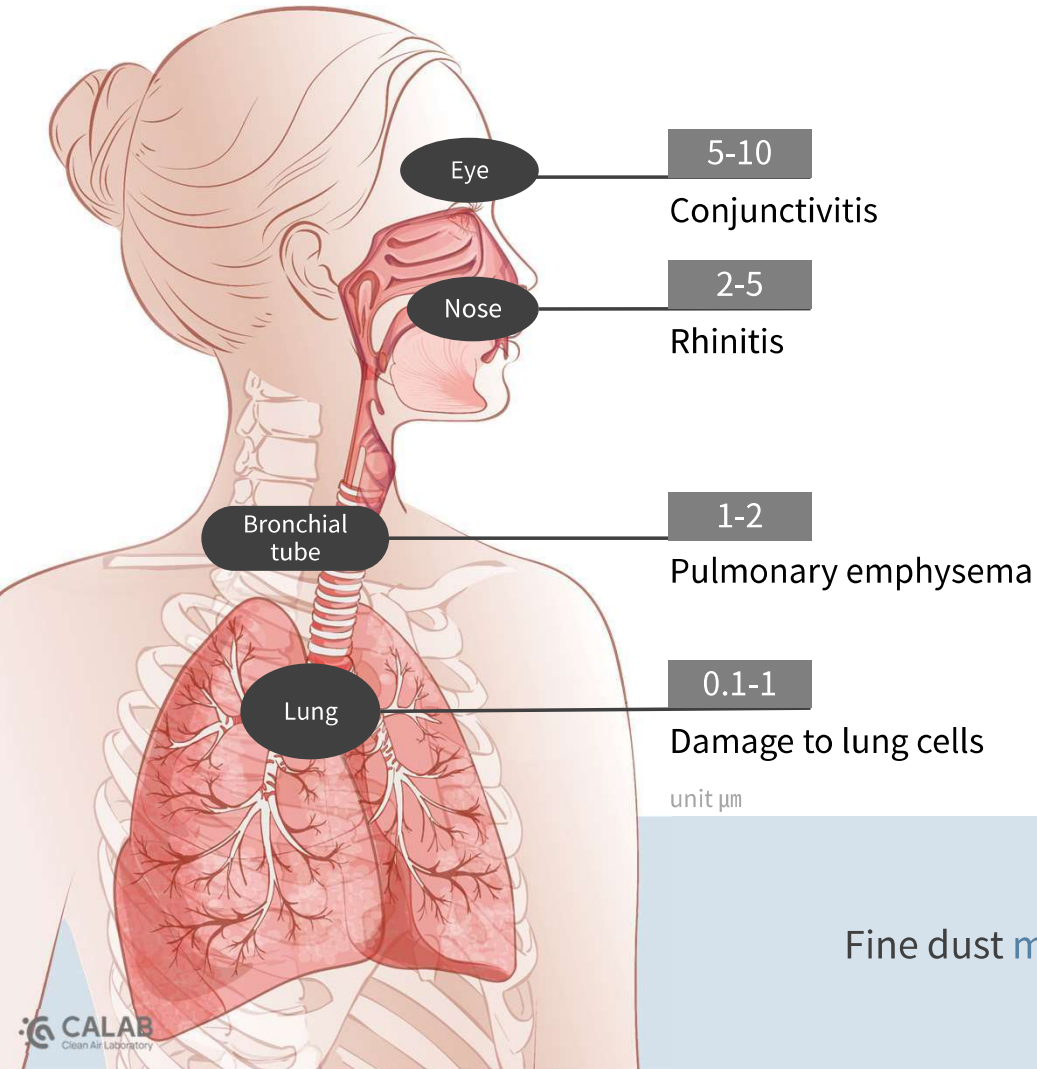

When increasing  $10\mu\text{g}/\text{m}^3$  of fine dust concentration

MI (myocardial infarction) patient

Mortality increase

**2.7** x

Diabetes patient

Mortality increase

**2.0** x

Heart failure patient

Mortality increase **2.5** x

Exposure to ultra fine dust for long time (Kid, Adult)

Possibility of Lung function reduction **4.9** x

Fine dust moves to lung through respiratory organ and accumulating inside the body along the blood vessel

Now,  
'Aero Formula'  
Solves.

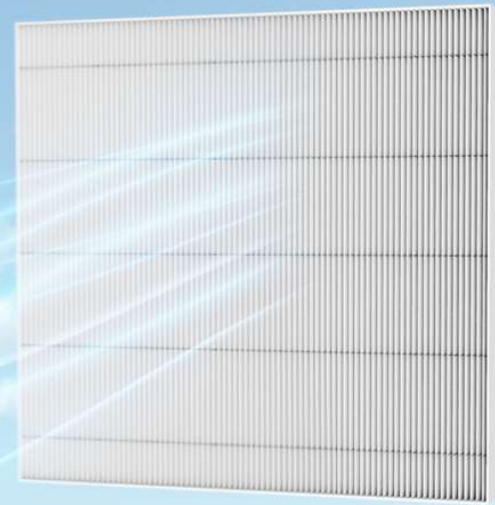



# Long-Life Cabin Air Filter 'Aero Formula'

Remove large dust as well as ultra fine dust  
For longer lifespan max 24 months  
by independent filter technology



More about  
**Aero Formula**

---

# 01 Dust collection / Purification

Remove not only ultra fine dust, but viruses max 99%  
Which are 0.3 $\mu$ m much smaller size than PM2.5  
With high-efficiency purifier level filter

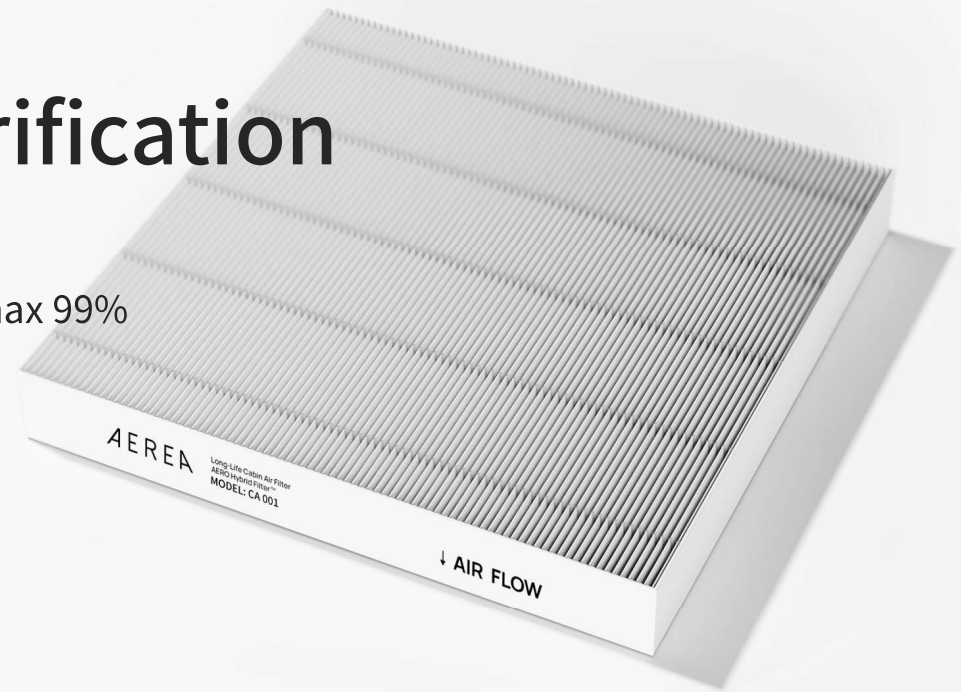

Only one filter can **remove 99%** ultrafine dust, bacteria and virus



Fine dust  
remove



Virus  
remove



Bacteria  
remove



Pollen  
remove



Ultra fine dust  
remove

Do you worry about the permeability of filter  
due to E12 level filter impacting conditioner ?

## No worry air permeability filter

---

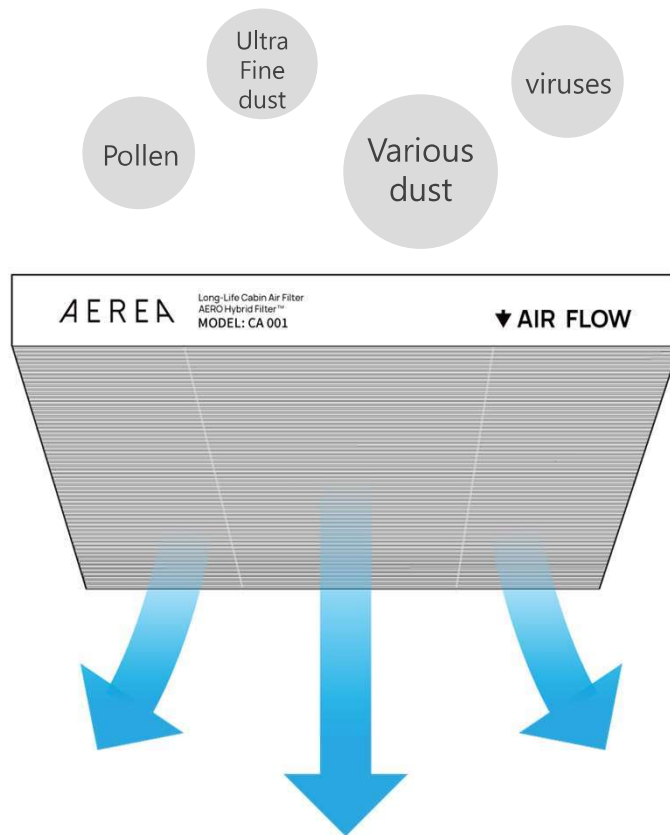

## “ AEREA’s filter is different!

Through Own core technology Hybrid Filter™,  
Keep E11 level air pressure, but realize E12 level high efficiency  
Remove ultra fine dust/virus/bacteria  
**Offer enough air at the same time.**

## AEREA filter feature

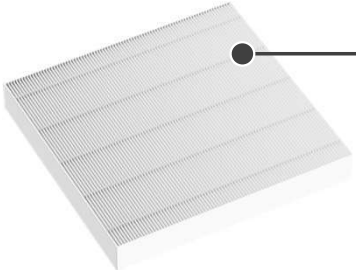
Other companies product		Aero Formula
		
Electrostatic filter	Filter	AERO Hybrid™ filter (electrostatic + NANO Multi Layer filter)
E11 (95%@0.3μm)	Collection efficiency	E12 (>99.5%@0.3μm)
A company E11 filter's air pressure 120 Pa B company E11 filter's air pressure 90 Pa (<196 Pa, standard of air cleaning association)	Permeability [300 CMH]	<81 Pa
3-6 months	Lifespan	24 months

### Aero Formula strengths

- ① Own core technology  
E12 filter without permeability problem
- ② Remove much smaller size 0.3μm  
Ultra fine dust (PM2.5, <2.5μm)
- ③ Without reduction of filter efficiency,  
**use the filter max 24 months**

## Reason why use E12 level filter

Only E12 level air conditioner filter can remove much smaller 0.3µm size particle than PM2.5  
Block MPPS as well and circulate the clean air inside car.

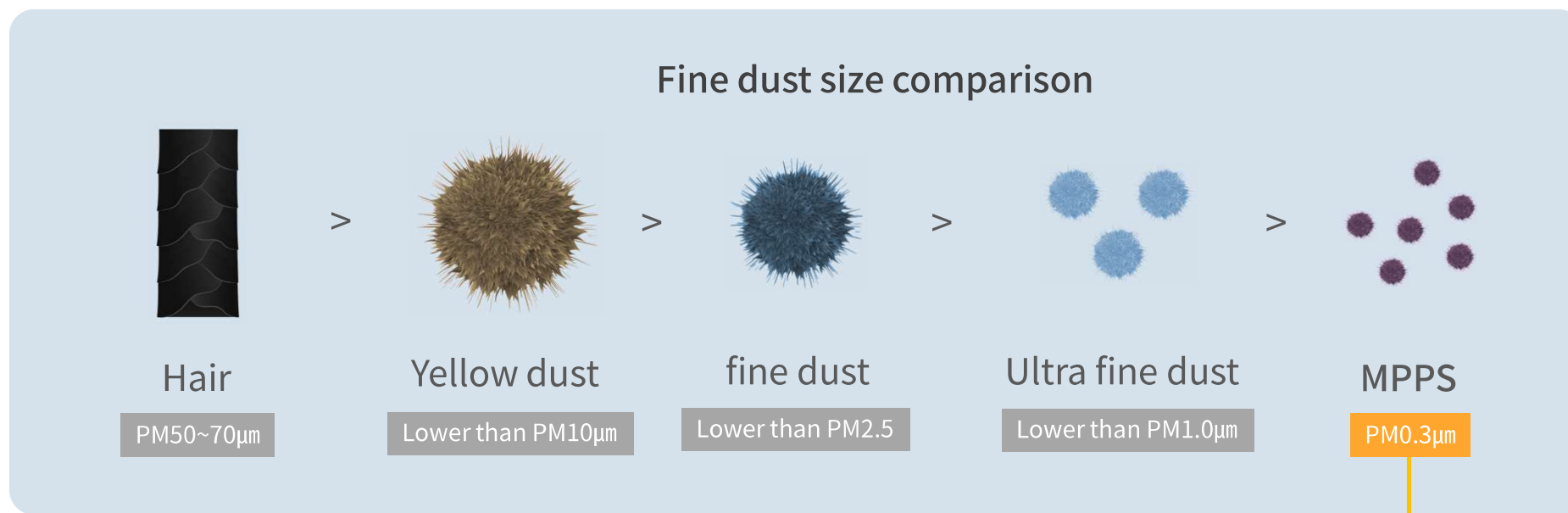

MPPS is 0.3µm size ultra fine dust which is **1 grade carcinogen** designated by 'international research on cancer' under WHO



# The secret of clean air

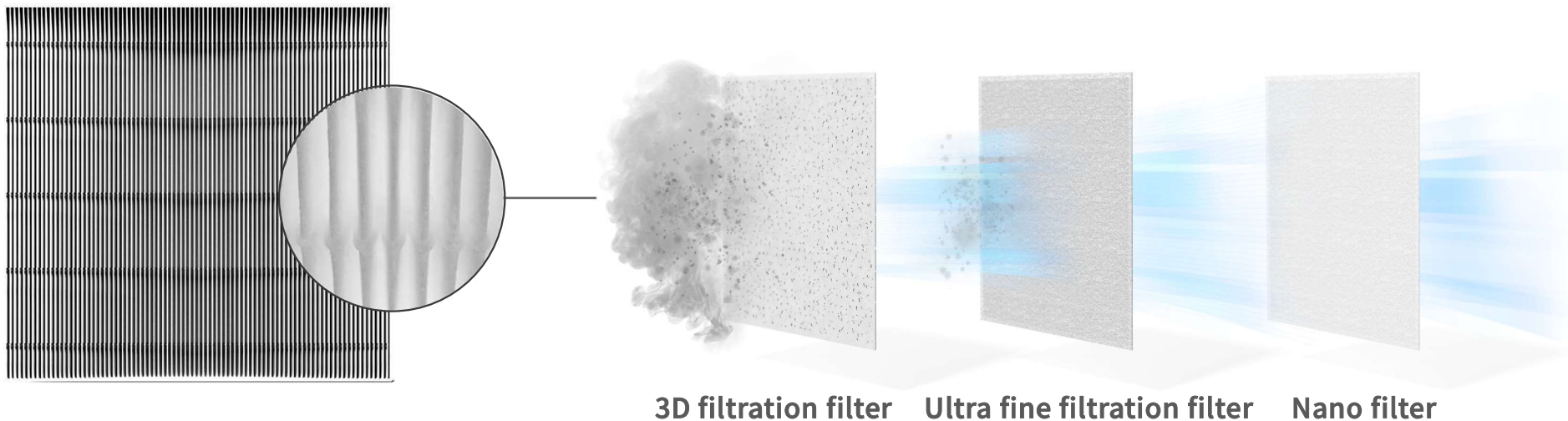

<b>3D filtration filter</b>	<b>Large dust / Droplet block</b>	Depending on dust size, it catches large dust such as pollen step by step. It helps to expand filter lifespan through preventing the dust clogging.
<b>Ultra fine filter</b>	<b>Ultra fine dust remove</b>	Apply MB filter which blocks ultra fine dust by electrostatic power, we minimize the air resistance and maximize the dust collection efficiency.
<b>Nano filter</b>	<b>Bacteria, Virus remove</b>	Block virus as well as bacteria which is 0.1µm size particle with Nano filtration layer that is strong against water based hydrophobic high molecule.

# The procedure of breathing clean air

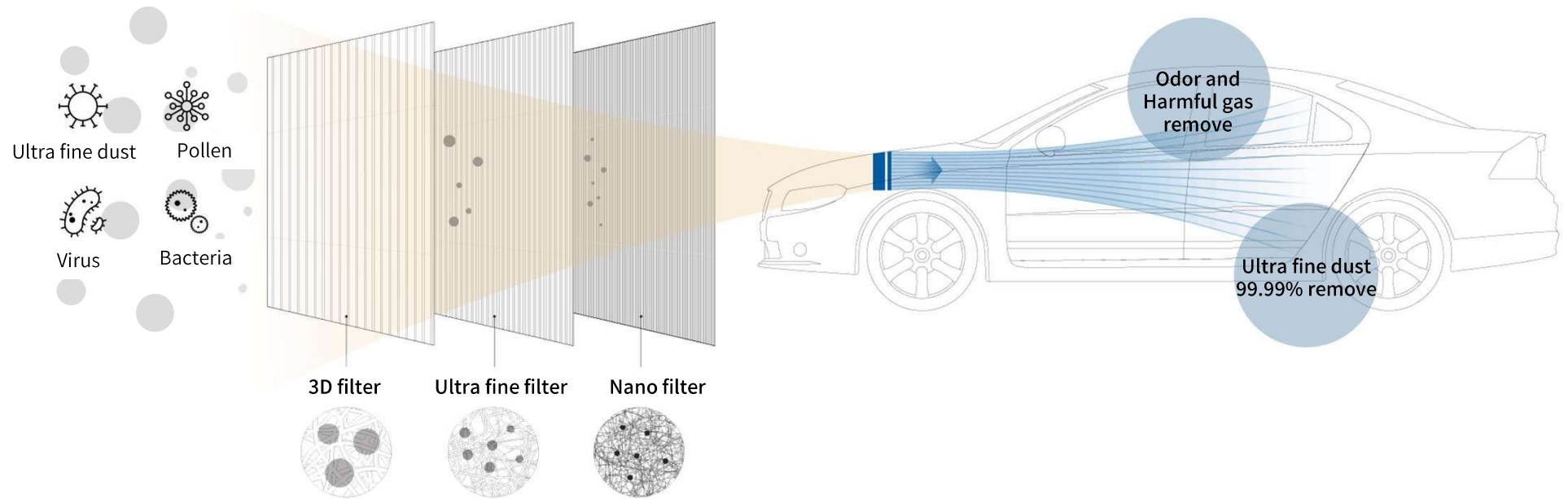

## Ultra fine dust test

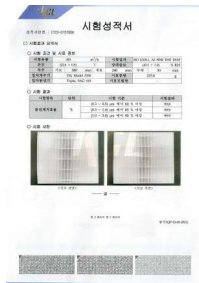

Test Item	Unit	Test result
Collection efficiency	%	99.8%
Permeability	Pa	81 Pa

Remove maximum 99.5% 0.3 $\mu$ m particle which is smaller than ultrafine dust(PM2.5, <2.5 $\mu$ m)

## Virus test

- Test result



Result	Reduction rate of Virus
Aero Hybrid Filter	76.4%

Remove 76.4% Floating virus in the air

# Harmful pneumonia test

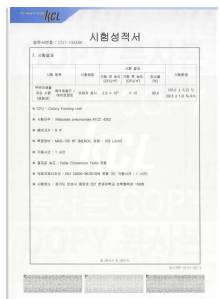

CFU	Colony Forming Unit
Test strains	Klebsiella pneumoniae ATCC 4352(harmful pneumonia)
Chamber size	8m <sup>2</sup>
Test sample	Aero Hybrid filter
Operating time	1hour
Result value concentration	Feller Conversion Table apply
Client proposal condition	ISO 16000-36:2018 (but, operating time : 1hour)

Harmful streptococcus pneumoniae

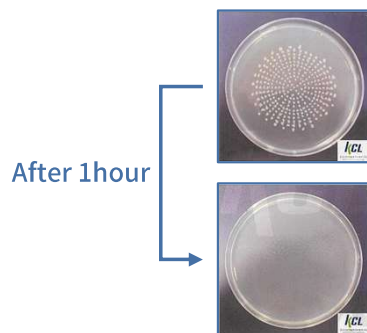

• Test result

Test item	Test method	Test result			Test environment
		Concentration before uptime	Concentration after uptime	Reduction rate (%)	
Microorganism reduction test (pneumonia)	Aero Hybrid filter Client proposal	2.7 x 10 <sup>4</sup>	< 10	99.9%	(23.0 ± 0.2) °C (50.5 ± 2.0) % R.H.

Remove harmful streptococcus pneumoniae floating in air [99.9%](#)

## 02 Technical skills

We realize the longer cabin filter for car by a multistage MB(Melt-Brown)filter and Nano filter with own filter design technology.

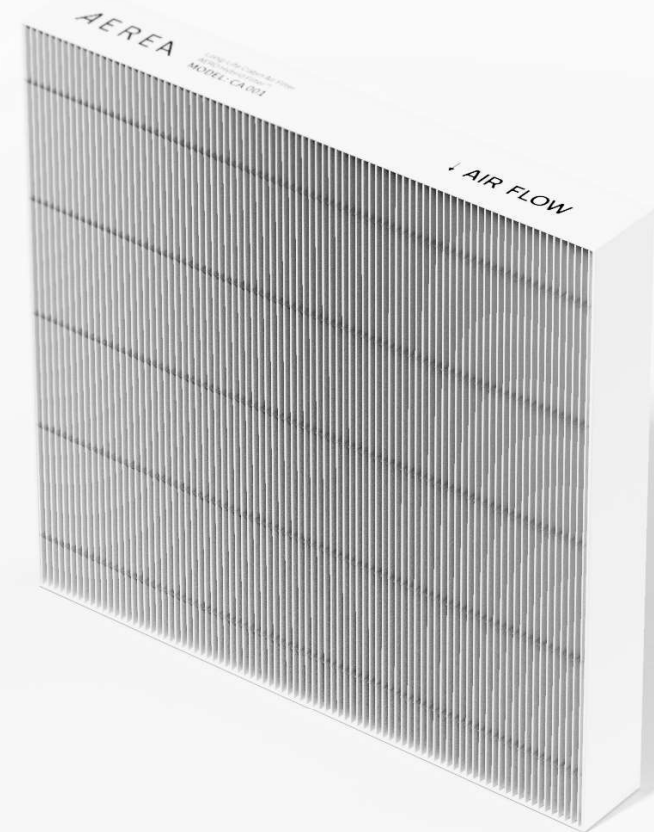

“

## Aero Formula 3 core function

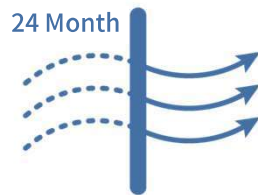

**24 months Long-Life filter**

Available to use max 24 month  
With Own AERO Hybrid Filter

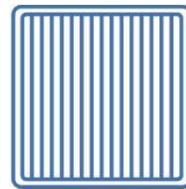

**E12 level high-efficiency filter**

Remove 0.3 $\mu$ m much smaller size  
than PM2.5 with high-efficiency  
purifier level filter



**ISO/KS performance approval**

ISO9001 quality management system  
international standard,  
KS filter performance estimation standard

# AERO Hybrid Filter™

\*MLFST: Multi-Layer Filter Media Simulation Tool

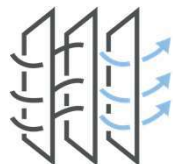

**Fiber & Flow Condition**  
(reflect properties of fibers and passing fluids)



**Collection Mechanism**  
(reflect particle acquisition mechanism)

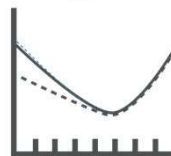

**Filter Efficiency Simulation**  
(filter dust collection efficiency & pressure loss prediction)

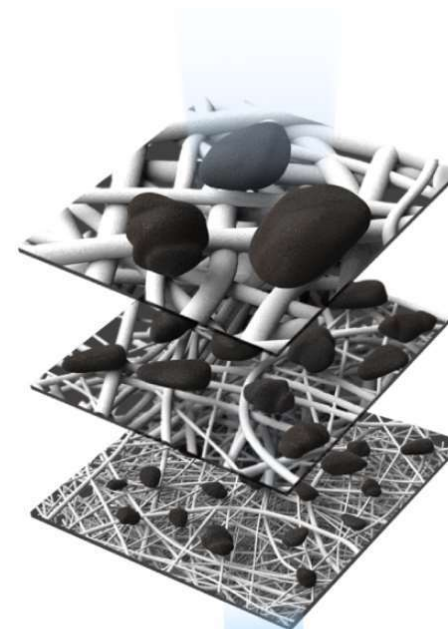

[ Apply more perfect and longer lifespan filter with AEREA's own Hybrid filter technology. ]

## Hot melt bonding

---

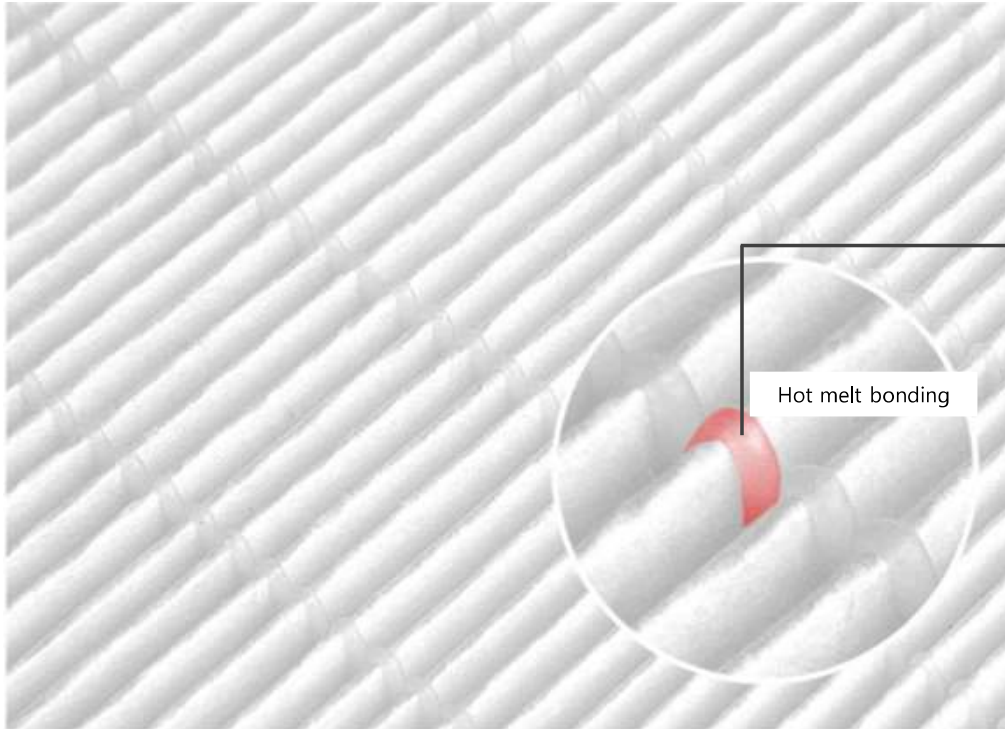

“

**Hot melt bonding : no overlapping wrinkle**

If the wrinkle reaches each other, the permeability would be reduced and the air cleaning performance won't work well.

This product maximizes the performance by keeping wrinkle Shape and space with optimized hot-melt bonding method in any situation.

Moreover, it maximizes permeability by expanding the fabric space through the hot-melt bonding.



# Patents possession



The production of CALAB 's function which blocks highly ultra fine dust smaller than 0.3μm, harmful gas and floating bacteria has been proved officially and based on various patents and intellectual property

# 03 Economics

The filter can use for max 24 months,  
And breathe clean air more economically.



## Guarantee economic efficiency with long lifespan

	Unit price	Replacement per every 2 years	Cost per year	Replacement cost for car maintenance period(10 years)
Sunjeong	44,800(kw)	4 times	89,600(kw)	896,000(kw)
A company	35,000(kw)	4 times	70,000(kw)	700,000(kw)
Aero Formula	30,000(kw)	1 time	15,000(kw)	150,000(kw)

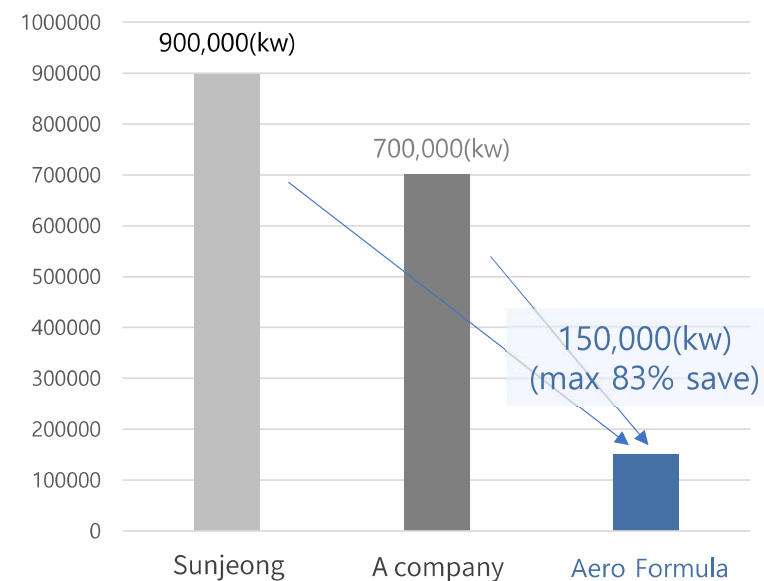

**AEREA's filter even guarantee your economic feasibility with 24 months long lifespan filter**

## How to replace the filter

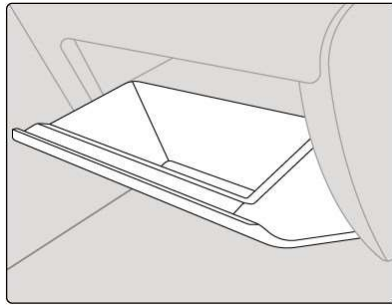

①

Open the globe box of passenger seat.

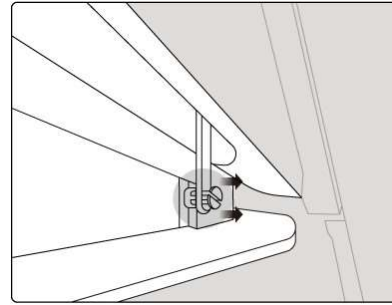

②

Release the fixing pin  
In right side of globe box.

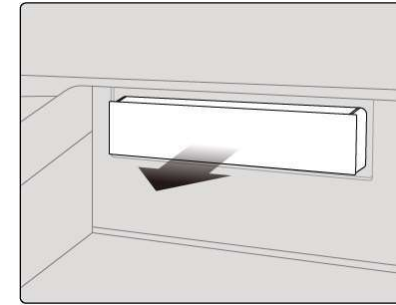

③

Open the filter cover,  
And take out the filter.

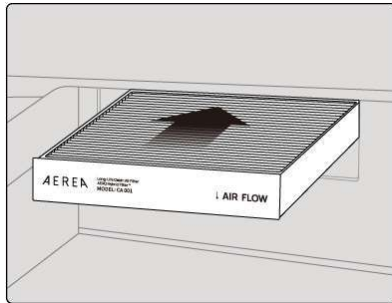

④

Install the filter the direction of arrow down.

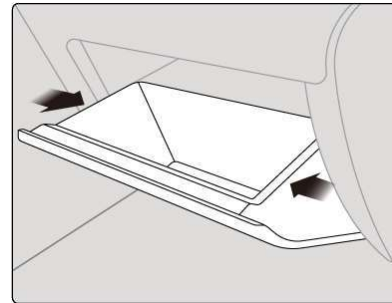

⑤

Press the both side of globe box  
And fit.

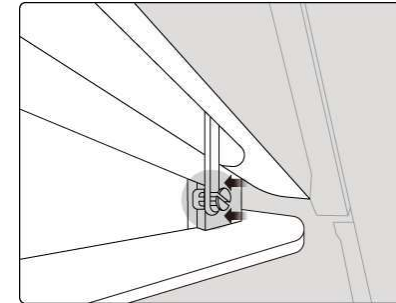

⑥

Fit the fixing pin !

## Product specification

---

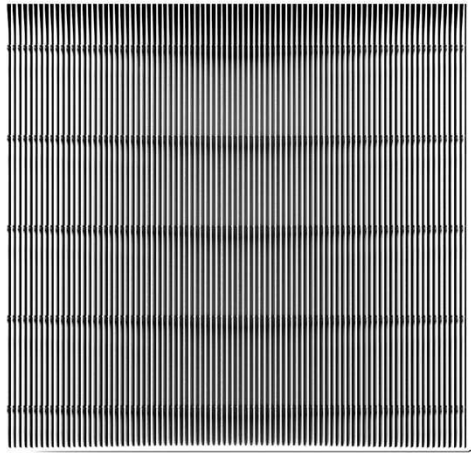

Depending on the product, the specification is different.

<b>Product name</b>	Aero Formula
<b>Model name</b>	CA 001 ~ 012
<b>Filter performance</b>	E12 Grade (>99%)
<b>Material</b>	PP / PVDF
<b>County of origin</b>	South Korea
<b>manufacturer</b>	CALAB Co., Ltd
<b>Warranty period</b>	12months

※depending on the location of the measurement, there may be 1 ~ 2cm error.

## Product specification

KIA				
Car model	Detail	year	size	Model No.
EV6	EV6 1 Generation	2021~	227x210x30T	CA 018
K3	K3/K3 diesel [1 <sup>st</sup> Generation, YD]	2012~2017	240x196x20T	CA 003
	K3 koup [YK]	2013~2017	240x196x20T	CA 003
	The new K3 [1 <sup>st</sup> Generation, YD]	2015~2018	240x196x20T	CA 003
	K3 [2 <sup>nd</sup> Generation, YD]	2018~	240x196x28T	CA 009
K5	K5[1st Generation, TF]	2010~2013	253x226x20T	CA 005
	K5 Hybrid/500h	2011~2015	253x226x20T	CA 005
	The new K5[1 <sup>st</sup> Generation Face Lift]	2013.06~2015	253x226x20T	CA 005
	All New K5 Hybrid	2016~2019	253x116x28T	CA 006
	[2 <sup>nd</sup> Generation JF HEV]	2016~2019	253x116x28T	CA 006
	All new K5 plug in/hybrid			
	[2 <sup>nd</sup> generation JF PHEV]			
The new K5 hybrid[2 <sup>nd</sup> generation JF]	2018.05~	253x116x28T	CA 006	
2020 K5/hybrid[DL3]	2020~	227x210x30T	CA 018	
K7	K7[VG]	2009~2016	253x226x20T	CA 005
	The new K7[VG]	2012~2016	253x226x20T	CA 005
	K7 hybrid 700h[VG]	2013~2016	253x226x20T	CA 005
	K7[YG]	2016~	253x116x28T	CA 006
	K7 hybrid[YG]	2016~	253x116x28T	CA 006
	K7 premier[YG/FL]	2019~	253x116x28T	CA 006
	K7 premier hybrid[ YG/FL]	2019~	253x116x28T	CA 006
K8	2021 K8[GL3]	2021~	227x210x30T	CA 018

## Product specification

KIA				
Car model	Detail	Year	Size	Model No.
K9	THE K9	2018~	252x222x30T	CA 004
Niro	Niro[1 <sup>st</sup> generation electronic, DE]	2016~2019	240x196x20T	CA 003
	Niro hybrid[HEV]	2016~	240x196x20T	CA 003
	Niro EV	2018	240x196x20T	CA 003
Ray	Ray [TAM]	2011~2017	176x175x12T	CA 014
	The new ray [TAM facelift]	2017~2019	176x175x12T	CA 014
Lotze	Lotze	2005.11~2007.04	250x220x30T	CA 013
	Lotze advance	2007.04~2008.06	250x220x30T	CA 013
morning	Morning [1generation ,SA]	2004~2008	176x175x12T	CA 014
	New morning[1generation face lift, SA]	2008.0.1~2011.01	176x175x12T	CA 014
	All new morning[2 <sup>nd</sup> generation, TA]	2011~2015	176x175x12T	CA 014
	The new morning [2 <sup>nd</sup> generation face lift. TA]	2015~2017	176x175x12T	CA 014
	All new morning[3generation,JA]	2017~	179x177x28T	CA 015
Mohave	The new Mohave	2008~2018	239x211x17T	CA 002
	Mohave the master	2019~	240x212x28T	CA007
Seltos	Seltos	2019~	224x201x28T	CA 008
Stonic	Stonic	2017~	224x201x28T	CA 008
Stinger	Stinger [1 <sup>st</sup> generation, incl. face lift model, CK]	2017~	252x222x30T	CA 004

## Product specification

KIA				
Car model	Detail	Year	Size	Model No.
Sportage	New Sportage [JE/KM]	2004~2010	225x203x17T	CA 001
	Sportage R[SL]	2010~2015	225x203x17T	CA 001
	All new Sportage	2016~	224x201x28T	CA 008
	Sportage the bold	2019~	224x201x28T	CA 008
	Sportage 5 <sup>th</sup> generation[NQ5]	2021~	227x210x30T	CA 018
Cerato	Cerato / new cerato	2003~2006	239x211x17T	CA 002
Sorento	Sorento R[2 <sup>nd</sup> Generation, XM]	2009~2014	239x211x17T	CA 002
	All new Sorento/ the new Sorento	2014~2018	240x212x28T	CA 007
	Sorento the master [3 <sup>rd</sup> generation face lift, UM]	2018~	240x212x28T	CA 007
	2020 Sorento/ hybrid	2020~	227x210x30T	CA 018
Soul booster	Soul booster/EV	2018~	224x201x28T	CA 008
Carnival	New carnival/Carnival R	2006~2014	239x211x17T	CA 002
	Grand carnival	2014~2015	239x211x17T	CA 002
	All new carnival	2014~	253x226x20T	CA 005
	Carnival 4 <sup>th</sup> generation[KA4]	2020~	253x226x30T	CA 019
Carence	New Carence	2006~2013	225x203x17T	CA 001
	All new Carence	2013~2016	240x196x20T	CA 003
Porte	Porte/Porte koup	2008~2016	225x203x17T	CA 001
	Porte hybrid	2008~2013.03	225x203x17T	CA 001



## Product specification

KIA				
Car Model	Detail	Year	Size	Model No.
Pride	Pride/New Pride	1997~2017	225x203x17T	CA 001
	Pride Hybrid	1997~2017	225x203x17T	CA 001
	All New Pride	1997~2017	225x203x17T	CA 001
	The New Pride	1997~2017	225x203x17T	CA 001
HYUNDAI				
Car Model	Detail	Year	Size	Model No.
i30	Latest i30	2011~2015	240x196x20T	CA 003
i31	i30 PD	2017~	240x196x28T	CA 009
i40	i40	2011~2018	225x203x17T	CA 001
Grand Starex	Grand Starex [3 <sup>rd</sup> Generation, TQ]	2007~2017	202x117x17T	CA 016
	The New Grand Starex [3 <sup>rd</sup> Generation Face Lift, TQ]	2017.12~	201x118x28T	CA 017
Grandeur	Grandeur [4 <sup>th</sup> Generation ,TG]	2005.05~2008.01	250x220x30T	CA 013
	Grandeur HG	2011~2016	253x226x20T	CA 005
	Grandeur HG Hybrid	2014~2017	253x226x20T	CA 005
	Grandeur IG/Hybrid	2016~2019.10	253x116x28T	CA 006
Nexo	Nexo	2018~	253x116x28T	CA 006
Max Cruise	Max Cruise	2013~2015	253x226x20T	CA 005
Venue	Venue [1 <sup>st</sup> Generation, QX1]	2019~	224x201x28T	CA 008

## 제품 사양

HYUNDAI				
Car Model	Detail	Year	Size	Model No.
Verna	Verna Transform	1996~2010	240x196x210T	CA 003
	Verna MC	2005~2009	240x196x210T	CA 003
Veloster	Veloster/The New Veloster	2011~2018	225x203x17T	CA 001
	The All New Veloster	2017~	224x201x28T	CA 008
	The All New Veloster N[JS]	2017~	224x201x28T	CA 008
Staria	Staria 4 <sup>th</sup> Generation [US4]	2021~	227x210x30T	CA 018
Santa fe	Santa Fe CM	2005.11~2007.12	250x220x30T	CA 013
	Santa Fe DM	2012~2015	253x226x20T	CA 005
	Santa Fe The Prime	2015~2018	253x226x28T	CA 006
	Santa Fe TM	2018~	253x226x28T	CA 006
	Santa Fe TM Face Lift	2020~	227x210x30T	CA 018
Sonata	NF Sonata	2004~2007	250x220x30T	CA 013
	YF Sonata/Hybrid	2009~2014	253x226x20T	CA 005
	LF Sonata	2014~	253x226x28T	CA 006
	Sonata New Rise/Hybrid	2017~	253x226x28T	CA 006
	2020 Sonata/Hybrid [DN8]	2020~	227x210x30T	CA 018
	2020 Sonata Sensuous/N line	2020~	227x210x30T	CA 018
Avante	Avante HD/Hybrid	2006~2013	240x196x210T	CA 003
	Avante MD/Hybrid	2010~2013	240x196x210T	CA 003
	The New Avante MD	2013~2015	240x196x210T	CA 003

## Product specification

HYUNDAI				
Car model	Detail	Year	Size	Model No.
Avante	Avante AD	2015~2019	240x196x28T	CA 009
	2020 avante [CN7]	2020~	227x210x30T	CA 018
Aslan	Aslan	2015~2018	253x226x20T	CA 005
ioniq	ioniq / hybrid	2016~2019	240x196x20T	CA 003
	The new ioniq hybrid	2019~	240x196x28T	CA 009
Ioniq 5	Ioniq 5[NE]	2021~	227x210x30T	CA 018
Equus	equus new version 3.8/4.6/5.0	2009~2015	252x222x30T	CA 004
Accent	Accent /new accent	2010~2017	225x203x17T	CA 001
	accent	2018~	224x201x28T	CA 008
All new mighty	All new mighty 3.5t truck	2015~	202x117x17T	CA 016
Genesis	Genesis coupe	2008~2016	225x203x17T	CA 001
	The new genesis coupe	2008~2016	225x203x17T	CA 001
	Genesis BH	2008~2013	252x222x30T	CA 004
	Genesis DH	2013~2016	252x222x30T	CA 004
	Genesis EQ900	2015~2017	252x222x30T	CA 004
	Genesis G70/80/90	2016~	252x222x30T	CA 004
Kona	Kona	2017~	224x201x28T	CA 008
	Kona EV	2018~	240x196x28T	CA 009
	Kona hybrid	2019~	224x201x28T	CA 008
Casper	Casper 2021[AX1]	2021~	179x177x28T	CA 015

# Product specification

HYUNDAI				
Car model	Detail	Year	Size	Model No.
Tucson	Tucson /tucson ix	2004~2015	225x203x17T	CA 001
	All new tucson	2015~2018	224x201x28T	CA 008
	Tucson [3generation face lift,TL]	2018~2020	224x201x28T	CA 008
	4generation[NX]	2020~	227x210x30T	CA 018
Palisade	Palisade [LX2]	2019~	240x212x28T	CA 007
CHEVROLET				
Car model	Detail	Year	Size	Model No.
Lacetti	Lacetti premier	2009~2011	240x204x35T	CA 011
Malibu	Malibu	~2016	240x204x35T	CA 011
	All new malibu [9generation,V400]	2016~	240x204x30T	CA 012
Bolt	Bolt plug in hybrid[EREV]	2016~	240x204x30T	CA 012
	Bolt EV	2017~	240x204x30T	CA 012
Spark	Spark	2013~2020	240x204x35T	CA 011
	Spark EV	2014~2016	240x204x35T	CA 011
	The next spark	2015.08~	240x204x35T	CA 011
Aveo	Aveo	2004~2016	240x204x35T	CA 011
	The new Aveo	2017~	240x204x35T	CA 011
Alpheon	Alpheon	2011~2016	240x204x35T	CA 011
Orlando	Orlando	2011~2018	240x204x35T	CA 011
Equinox	Equinox	2018~	240x204x30T	CA 012
Impala	Impala	2014~	240x204x30T	CA 012

## Product specification

CHEVROLET				
Car model	Detail	Year	Size	Model No.
Camaro	Camaro SS	2016~	240x204x30T	CA 012
Cadillac	Cadillac SRX	2010~2016	240x204x35T	CA 011
	Cadillac ATS	2013~	240x204x30T	CA 012
	Cadillac CTS	2014~	240x204x30T	CA 012
	Cadillac CT6	2016~	240x204x30T	CA 012
	Cadillac XT5	2017~	240x204x30T	CA 012
	Cadillac CT5	2020~	240x204x30T	CA 012
Colorado	Colorado	2018~	240x204x30T	CA 012
Cruze	Cruze [including hatchback model]	2011~2016	240x204x35T	CA 011
	All new cruze	2016~	240x204x30T	CA 012
Trax	Trax	2013~2016	240x204x35T	CA 011
	The new trax	2017~	240x204x35T	CA 011
Traverse	Traverse	2018~	240x204x30T	CA 012
Trail blazer	Trail blazer [1 <sup>st</sup> Generation ,9BYC]	2020~	240x204x30T	CA 012

## Product specification

---

Ssang-Yong motors				
Car model	Detail	Year	Size	Model No.
Tivoli	Tivoli	2015~2016	180x180x25T	CA 010
	Tivoli air	2015~2019	180x180x25T	CA 010
	Tivoli armour	2015~2019	180x180x25T	CA 010

# Thank you !



---

**Call**  
+82 51 754 2721

**Address**  
A-3511, 97, Centum jungang-ro, Haeundae-gu, Busan

**Web site**  
[www.calab.kr](http://www.calab.kr)