

LUMUX

STEP LIGHT SL420SS

DATE: _____
PROJECT: _____
FIRM: _____
CATALOG NO.: _____
COMMENTS: _____



SL420SS from Lumux is an elegant architectural step light featuring a precision engineered stainless steel faceplate for durability and performance.

SL420SS offers a distinctively contemporary design with crosshair grill gaurd. Ideal for illuminating steps, facades, and walls, SL420SS is a powerful outdoor LED solution. SL400SS Series step lights are energy-efficient for long-lasting indoor and outdoor applications, recessed mounted with a CPX housing for wall, masonry, or concrete insallation. Part of the collection that includes SL400SS, SL410SS, and SL450SS. Constant Current or 12V DC options.

up to **250** lm **4** w average **60** lm/W

Content of specification sheet subject to change

LUMUX

STEP LIGHT SL420SS

SL420SS is an elegant step and wall accent light with a crosshair lens grill, perfect for commercial spaces, campus, resort and residential use.

Ordering Guide

Catalog No.	LED Color	Color Temp ¹	Voltage	Finish ²	Options ²
SL420SS	White	2700K	120-277v	Stainless Steel	<input type="checkbox"/> 0-10v Dimming <input type="checkbox"/> 12V DC
	Amber-TFA	3000K		Black	
	Red	3500K		White	
	Green	4000K		Silver	
	Blue			Bronze	
				Custom RAL ²	

¹Consult factory for additional options

²Consult factory for additional pricing for powdercoat finishes

Catalog No.: _____

Performance Specifications	
Flux 250 lm (4000K)	LER 60 lm/W
Power 4W	120-277v input voltage
Starting temp. rated to -20°F	Constant Current standard
Dimmable driver (0-10v) option	12V DC optional
Lumen Maintenance*: L70 100K hrs	

Environmental Specifications	
BUG rating: per orientation	TFA turtle-friendly amber option
CRI 80	Color temperature options
IP65	ETL listed for wet-locations
Effective Projected Area n/a	Marine Grade option
5-year limited warranty	Made in the USA

Delivered Lumens & Wattage per color temperature:

	2700K	3000K	3500K	4000K	WATTS
SL420SS	220 lm	230 lm	250 lm	250 lm	4W

For higher lumen packages, please consult the Lumux sales team.

TFA turtle-friendly amber light provides 80 lumens at 2.3W.

Housing: SL420SS features a stainless steel faceplate with a crosshair lens grill, mounted to a diecast low-copper aluminum housing with vandal-resistant stainless steel screws.

Lens: Sealed one-piece shatter-proof frosted glass diffuser.

Gasket: Closed-cell silicone foam gasket that seals out moisture, dust, and insects, for weather tight operation.

Mounting: Surface-mounted or recessed, with the housing acting as the concrete pour-box.

Installation: Please refer to installation instructions.

Finish: Stainless steel, with optional zinc-polyester powdercoat finish in black, white, silver, bronze, or any custom RAL color. Consult factory for marine grade or anti-microbial finish.



Dimensions

*Lumen Maintenance Report: Forzlux BB03AA

Content of specification sheet subject to change

LUMUX

STEP LIGHT SL420SS (DOWNLIGHT ORIENTATION)

Photometry	IESNA: LM-63-2002
TEST: L102310203	TEST LAB: Light Laboratory Inc.
LUMINAIRE: SL400SS	DATE: 2023-10-04
IES Classification: Type VS	Longitudinal Class: Very Short
Luminaire Lumens	249 (4000K)
Luminaire Efficacy Rating (LER)	64
Total Luminaire Watts	3.88W
Upward Waste Light Ratio	0.00
Max. Candela	105
Max. Cd. < 90° Vertical	105
Max. Cd. (At 90 Deg. Vert.)	0 (0.0% Luminaire)
Max. Cd. (80 to <90 Deg. Vert.)	5 (2.0% Luminaire)
Cutoff Classification: N.A.	BUG Rating: B0-U0-G0

Technical aspects may change without notice.

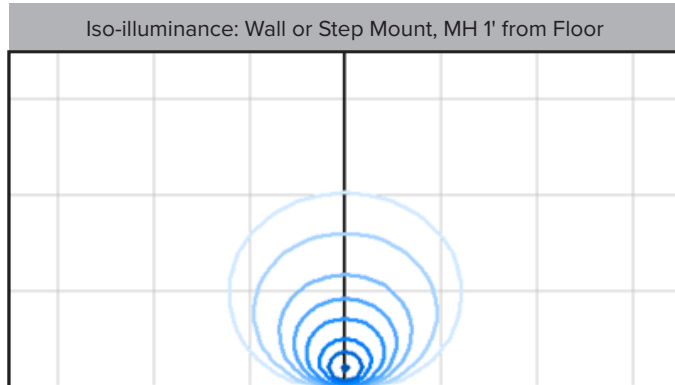

Foot-candles: 0.1, 0.2, 0.5, 1, 2, 5, 10, 20 | Grid spacing 5'

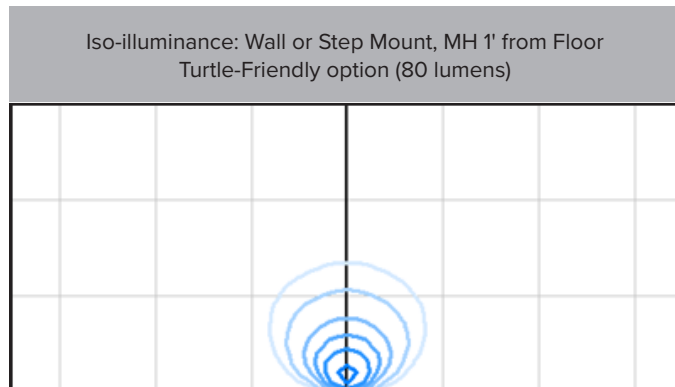

Foot-candles: 0.1, 0.2, 0.5, 1, 2, 5 | Grid spacing 5'

Candela

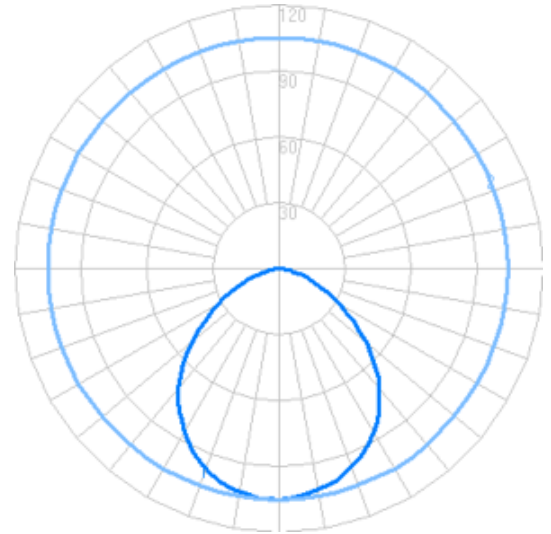

Zonal Lumens

LCS	Zone	Lumens	%Lum.
FL	(0-30)	40.2	16.1
FM	(30-60)	66.9	26.8
FH	(60-80)	17.0	6.8
FVH	(80-90)	1.2	0.5
BL	(0-30)	40.3	16.2
BM	(30-60)	66.4	26.6
BH	(60-80)	16.3	6.5
BVH	(80-90)	1.0	0.4
UL	(90-100)	0.0	0.0
UH	(100-180)	0.0	0.0
Total		249	100

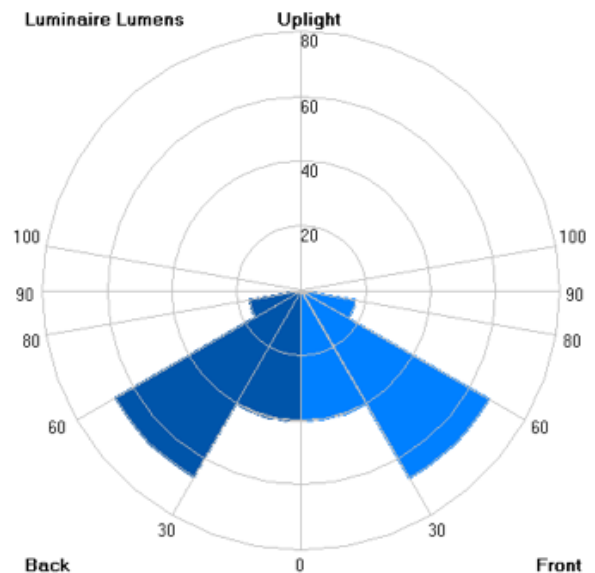

Content of specification sheet subject to change

LUMUX LIGHTING

Sample isoilluminance plots. For actual values, use Lumux IES file with photometry software and correct surface reflectances.

7803 Industry Ave, Pico Rivera, CA 90660
sales@lumux.com | 562-801-5100

LUMUX

HOUSING & CPX CONCRETE POUR BOX DIMENSIONS

SL400SS SERIES

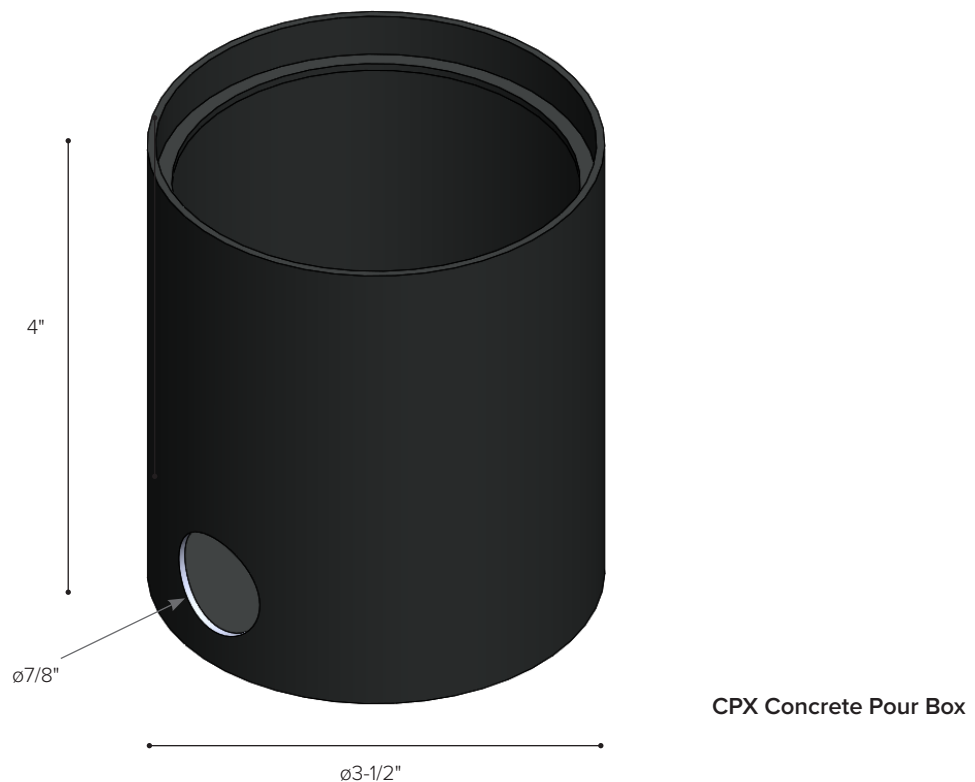
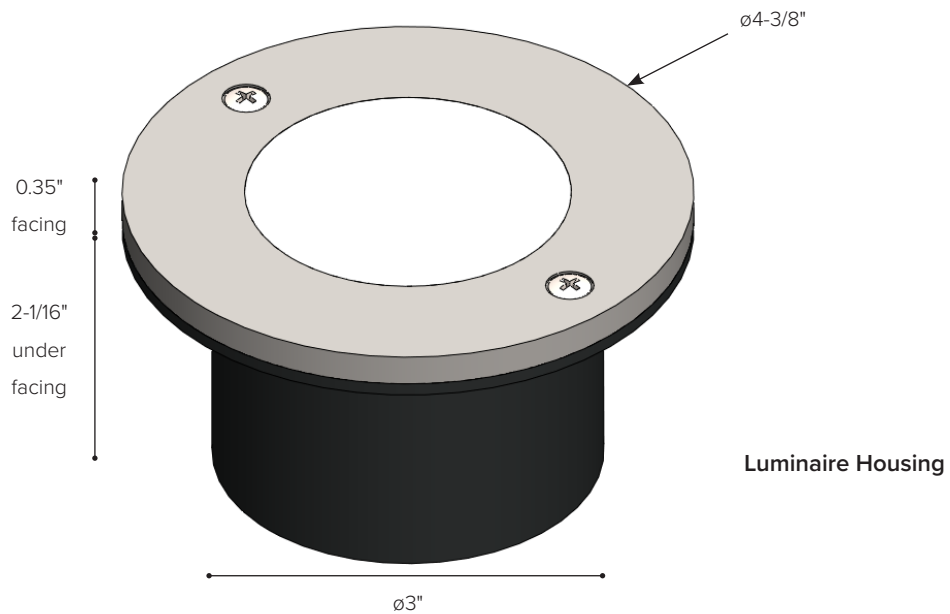

Content of specification sheet subject to change

LUMUX

LUMINAIRES IN THIS COLLECTION



SL400SS



SL420SS



SL450SS

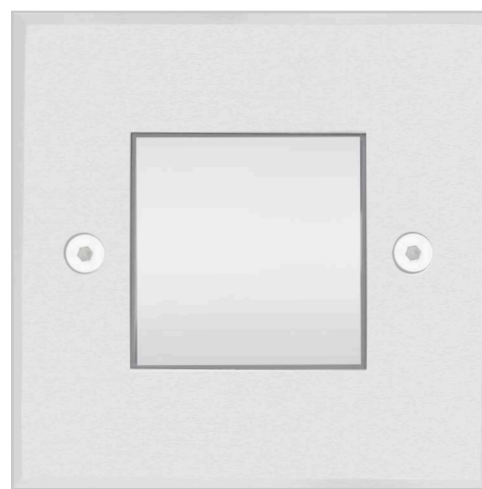

SL410SS