

LUMUX

POST TOP LIGHTING

PT600

The Lumux Post Top ("PT") series is a family of precision engineered, energy efficient LED architectural post tops that are designed for durability and performance. Constructed from the highest quality materials and components, the PT series is a powerful solution to illuminate large areas such as parking lots, public spaces, common areas, parks, entrance ways, in addition to many others. The Lumux PT housing features low-copper, corrosion resistant, die cast aluminum that is designed for long-lasting applications in severe weather conditions. All hardware is vandal resistant, stainless-steel while also featuring closed cell, silicon foam gasketing that seals out moisture, dust, and insects for weather-tight operation. All Lumux PT luminaires are dark-sky friendly, as all models offer a shielded light source with either a visor or a hood, while a glass diffuser reduces glare and enhances visual comfort. The PT series offers a range of design options that are suitable for both modern and classic architecture and a variety of mounting and installation options are available such as pole mounting, wall mounting, or pendant mounting.

Housing: Heavy-duty construction of corrosion resistant, low-copper die cast aluminum. All hardware is vandal resistant, grade 316 stainless-steel.

Lens: 1/8" thick shatter proof clear polycarbonate diffuser.

Mounting: Pole mount.

Installation: Post top tenon is 3.5" in diameter by 3.5" in depth.

Finish: Zinc polyester powder coat finish in black, white, silver, bronze, or any custom RAL color. Consult factory for marine grade or anti-microbial finish.

Driver: Constant current and universal input voltage 120/277V, starting temperature rated at -20°F. Dimmable option available (0-10v).

Gasket: Closed cell silicon foam gasket that seals out moisture, dust, and insects for weather tight operation.

Protection Class: IP65, ETL Listed for wet locations.

Wattage: 53.4W

CRI: 80

Warranty: 5 year limited warranty

Delivered Lumens per Color Temperature:

	2700K	3000K	3500K	4000K
Type 2	4,900 lm	5,000 lm	5,100 lm	5,300 lm
Type 3	5,250 lm	5,350 lm	5,500 lm	5,700 lm
Type 4	5,350 lm	5,400 lm	5,600 lm	5,800 lm
Type 5	5,250 lm	5,350 lm	5,500 lm	5,700 lm

DATE: _____

PROJECT: _____

FIRM: _____

CATALOG NO.: _____

COMMENTS: _____



Dimensions:

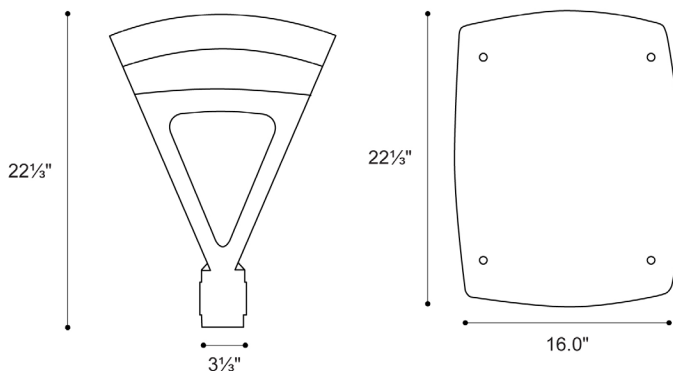

Anchorage:

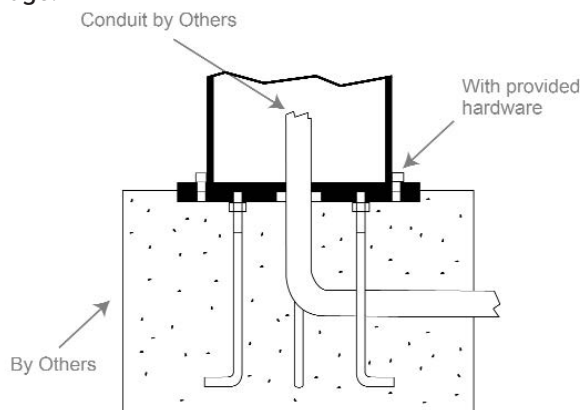

Content of specification sheet subject to change

LUMUX

POST TOP LIGHTING

PT600 - OPTION TYPES 2, 3, 4, 5

DATE:

PROJECT:

FIRM:

CATALOG NO.:

COMMENTS:

Ordering Guide:

Catalog No.	Flux 4000K	LED Color	Color Temp ¹	Voltage	Finish	Options ¹
PT600 - Type 2	5,300 lm	White	2700K	120-277v	Black	<input type="checkbox"/> Dimmable driver (0-10v)
PT600 - Type 3	5,750 lm		3000K		White	
PT600 - Type 4	5,800 lm		3500K		Silver	
PT600 - Type 5 ²	5,700 lm		4000K		Bronze	
					Custom RAL ²	

¹Consult factory for additional options, pricing & pole lengths

²PT600-Type 5 is Dark Sky Compliant

Please consult factory for higher lumen packages

Catalog No.: _____

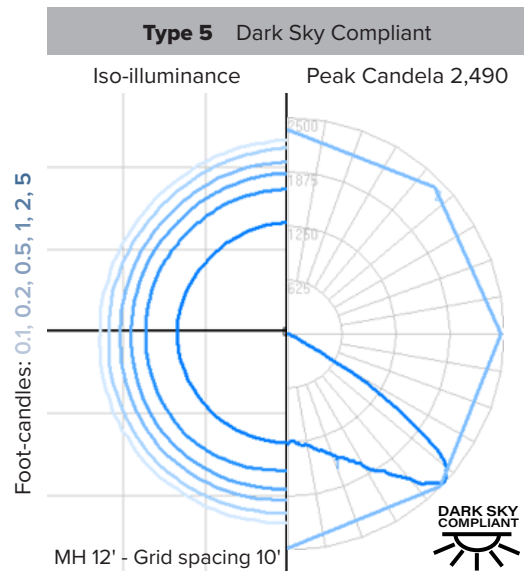
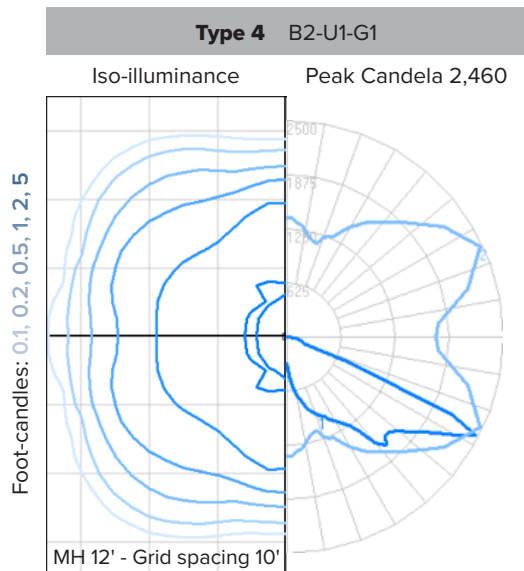
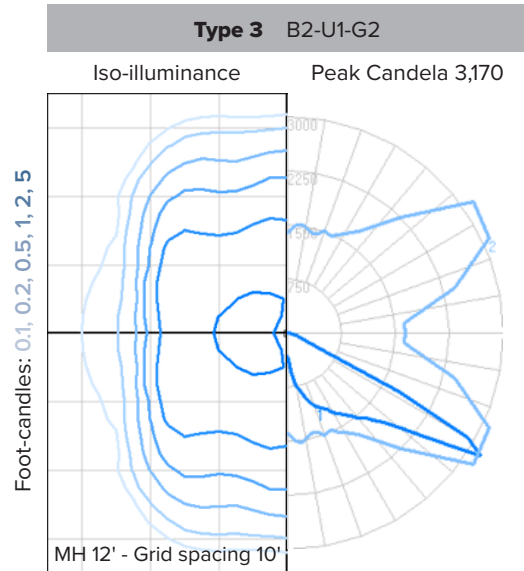
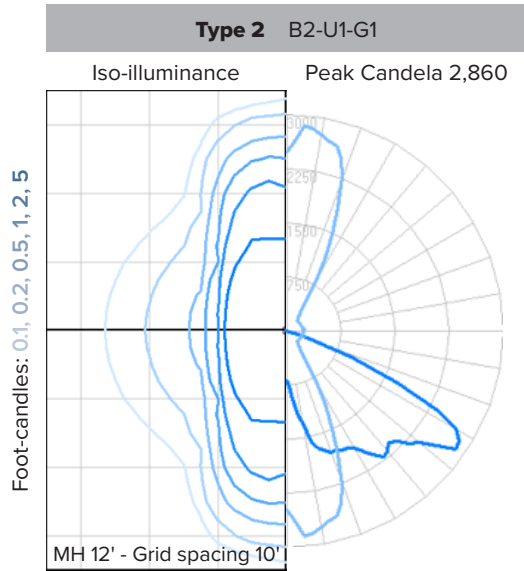

Content of specification sheet subject to change

LUMUX

POST TOP LIGHTING

PT600

DATE:

PROJECT:

FIRM:

CATALOG NO.:

COMMENTS:

Performance Specifications

Flux 5,300 - 5,800 lm (40K)	LER 100 - 114 lm/W (40K)
Power 53.4W	120-277v input voltage
Starting temp. rated to -20°F	
Dimmable driver (0-10v) option	
Lumen Maintenance*: c.f. Lumileds 3030 2D	

Environmental Specifications

BUG rating: B2-U1-G1 typical	Type 5 is Dark Sky Compliant
CRI 80	Color temperature options
IP65 / ETL listed for wet-locations	Marine Grade option
Effective Projected Area 3.0 ft2 (not including pole)	
5-year limited warranty	Made in the USA



*Lumen Maintenance Report: c.f. Lumileds 3030 2D

Content of specification sheet subject to change

LUMUX

POST TOP LIGHTING

PT600 - TYPE 2

DATE: _____

PROJECT: _____

FIRM: _____

CATALOG NO.: _____

COMMENTS: _____

Photometry	IESNA: LM-63-2002
TEST: 14493075.01	TEST LAB: UL LLC
LUMINAIRE: PT600 - Type 2	DATE: 2022-09-19
IES Classification: I	Long. Class: Short
Luminaire Lumens	5343 (4000K)
Luminaire Efficacy Rating (LER)	100
Total Luminaire Watts	53.4W
Upward Waste Light Ratio	0.00
Max. Candela	2861.9
Max. Cd. < 90° Vertical	2861.9
Max. Cd. (At 90 Deg. Vert.)	18.2 (0.3% Luminaire)
Max. Cd. (80 to <90 Deg. Vert.)	95.3 (1.8% Luminaire)
Cutoff Classification	Cutoff
BUG Rating	B2-U1-G1

Technical aspects may change without notice.

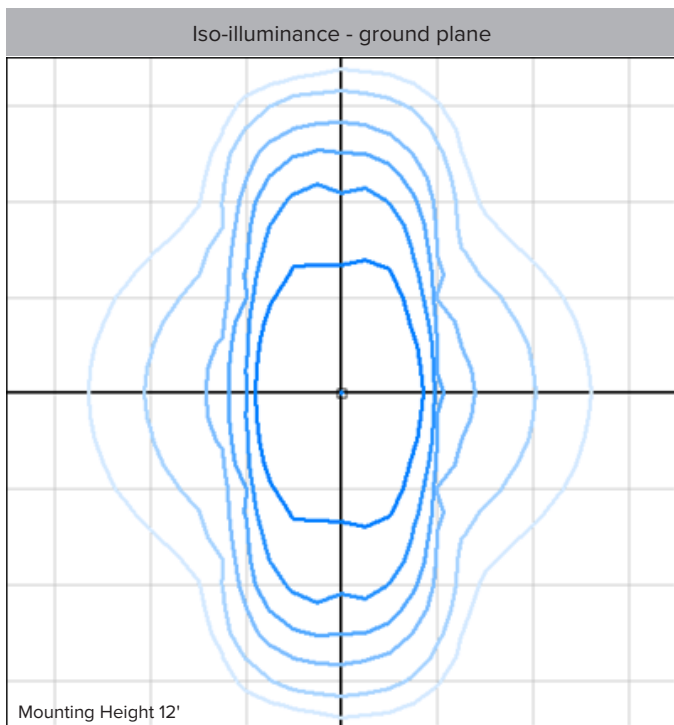

Foot-candles: 0.1, 0.2, 0.5, 1, 2, 5 | Grid spacing 10'

Sample isoilluminance plot. For actual values, use Lumux IES file with photometry software and correct surface reflectances.

Candela

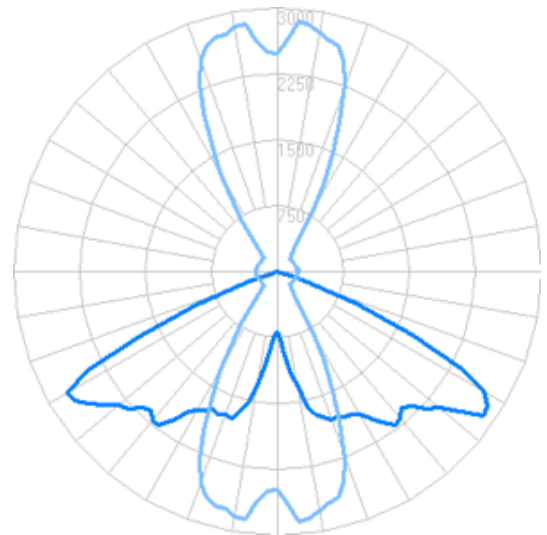

Zonal Lumens

LCS	Zone	Lumens	%Lum.
FL	(0-30)	796.6	14.9
FM	(30-60)	1497.5	28.0
FH	(60-80)	281.6	5.3
FVH	(80-90)	14.8	0.3
BL	(0-30)	732.9	13.7
BM	(30-60)	1669.2	31.2
BH	(60-80)	320.3	6.0
BVH	(80-90)	18.8	0.4
UL	(90-100)	5.9	0.1
UH	(100-180)	5.7	0.1
Total		5343	100.0

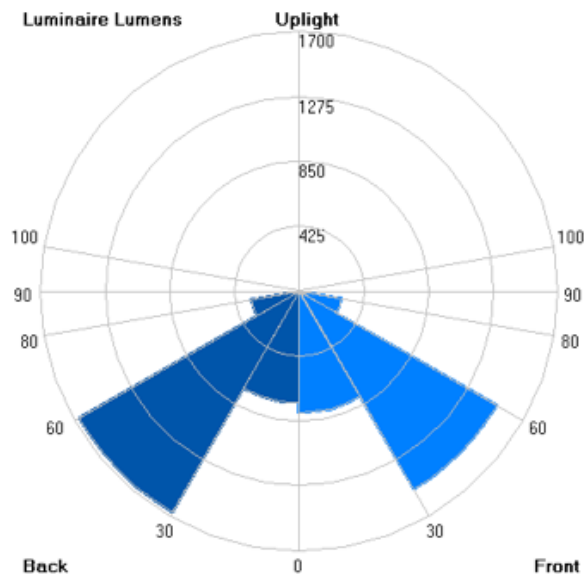

Content of specification sheet subject to change

LUMUX

POST TOP LIGHTING

PT600 - TYPE 3

DATE: _____

PROJECT: _____

FIRM: _____

CATALOG NO.: _____

COMMENTS: _____

Photometry	IESNA: LM-63-2002
TEST: 14493075.02	TEST LAB: UL LLC
LUMINAIRE: PT600 - Type 3	DATE: 2022-09-19
IES Classification: II	Long. Class: Very Short
Luminaire Lumens	5778 (4000K)
Luminaire Efficacy Rating (LER)	108
Total Luminaire Watts	53.4W
Upward Waste Light Ratio	0.00
Max. Candela	3173.2
Max. Cd. < 90° Vertical	3173.2
Max. Cd. (At 90 Deg. Vert.)	32.4 (0.6% Luminaire)
Max. Cd. (80 to <90 Deg. Vert.)	156.3 (2.7% Luminaire)
Cutoff Classification	n/a
BUG Rating	B2-U1-G2

Technical aspects may change without notice.

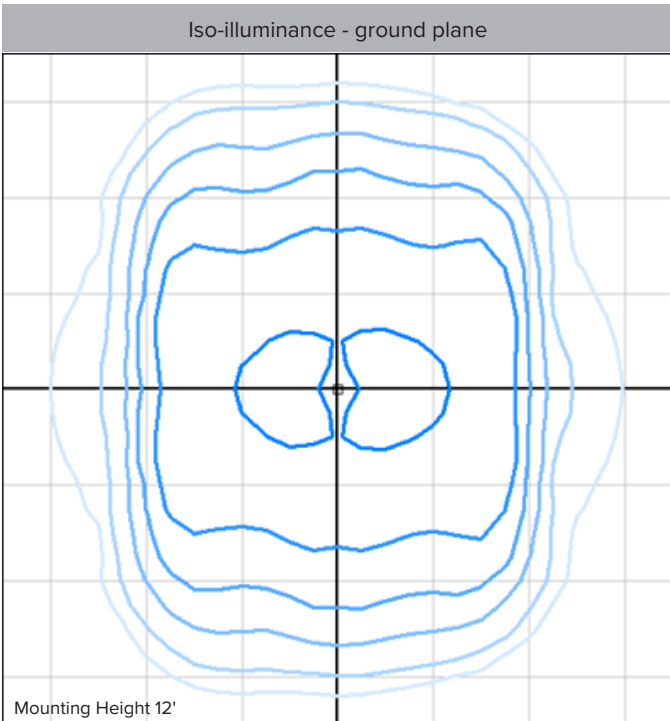

Foot-candles: 0.1, 0.2, 0.5, 1, 2, 5 | Grid spacing 10'

Sample isoillumiance plot. For actual values, use Lumux IES file with photometry software and correct surface reflectances.

Candela

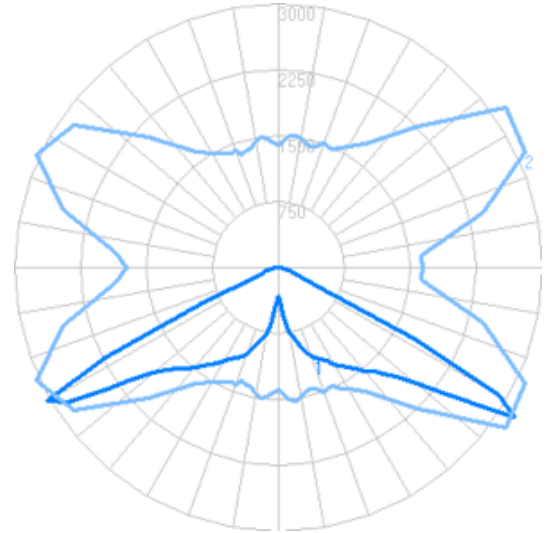

Zonal Lumens

LCS	Zone	Lumens	%Lum.
FL	(0-30)	409.3	7.1
FM	(30-60)	1937.4	33.5
FH	(60-80)	528.8	9.2
FVH	(80-90)	21.3	0.4
BL	(0-30)	403.9	7.0
BM	(30-60)	1868.4	32.3
BH	(60-80)	578.8	10.0
BVH	(80-90)	22.3	0.4
UL	(90-100)	4.2	0.1
UH	(100-180)	3.3	0.1
Total		5778	100.0

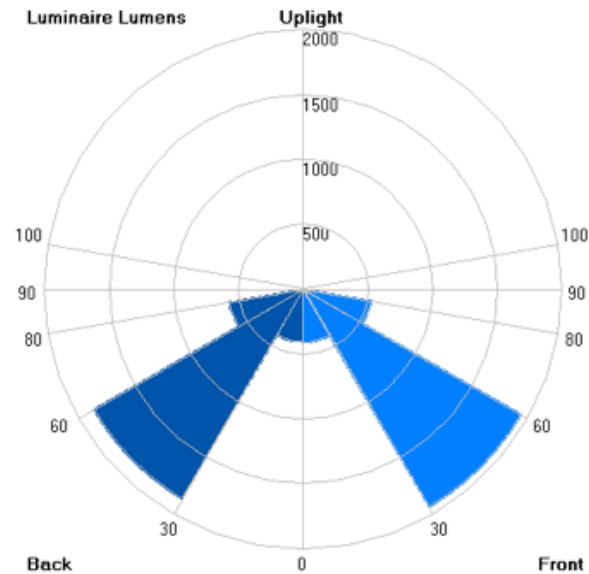

Content of specification sheet subject to change

LUMUX

POST TOP LIGHTING

PT600 - TYPE 4

DATE:

PROJECT:

FIRM:

CATALOG NO.:

COMMENTS:

Photometry	IESNA: LM-63-2002
TEST: 14493075.03	TEST LAB: UL LLC
LUMINAIRE: PT600 - Type 4	DATE: 2022-09-20
IES Classification: VS	Long. Class: Very Short
Luminaire Lumens	5841 (4000K)
Luminaire Efficacy Rating (LER)	109
Total Luminaire Watts	53.4W
Upward Waste Light Ratio	0.00
Max. Candela	2466.5
Max. Cd. < 90° Vertical	2466.5
Max. Cd. (At 90 Deg. Vert.)	32.6 (0.6% Luminaire)
Max. Cd. (80 to <90 Deg. Vert.)	169.1 (2.9% Luminaire)
Cutoff Classification	n/a
BUG Rating	B2-U1-G1

Technical aspects may change without notice.

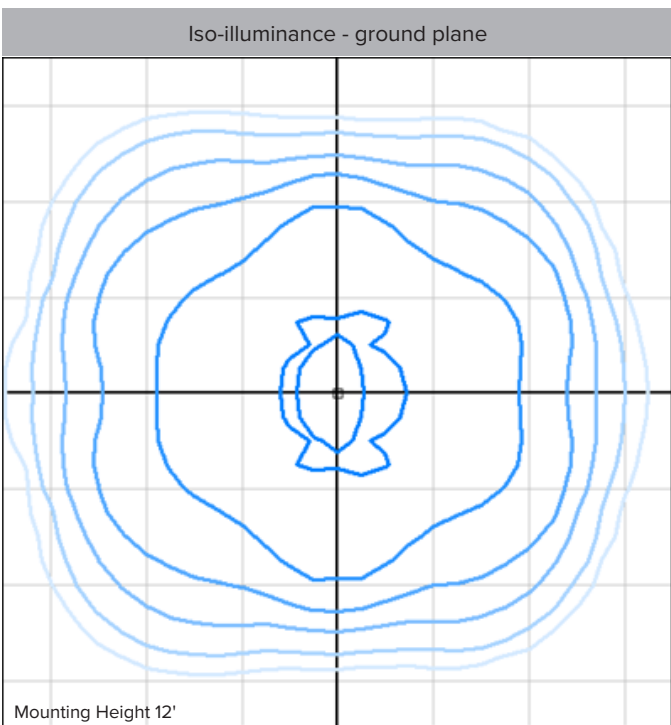

Foot-candles: 0.1, 0.2, 0.5, 1, 2, 5 | Grid spacing 10'

Sample isoillumiance plot. For actual values, use Lumux IES file with photometry software and correct surface reflectances.

Candela

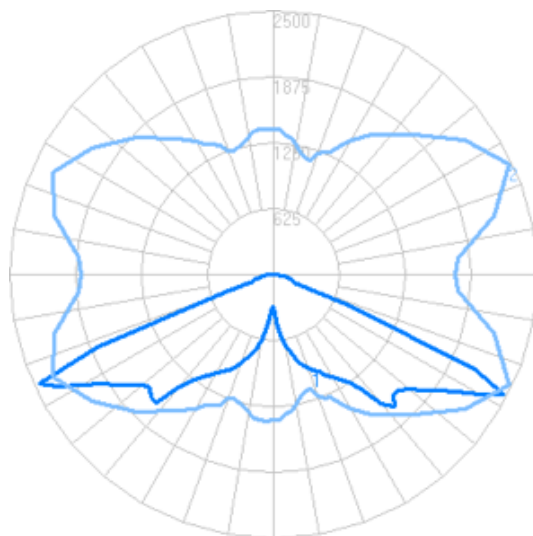

Zonal Lumens

LCS	Zone	Lumens	%Lum.
FL	(0-30)	373.8	6.4
FM	(30-60)	1822.6	31.2
FH	(60-80)	673.9	11.5
FVH	(80-90)	17.8	0.3
BL	(0-30)	359.5	6.2
BM	(30-60)	1778.1	30.4
BH	(60-80)	784.1	13.4
BVH	(80-90)	23.3	0.4
UL	(90-100)	4.0	0.1
UH	(100-180)	3.6	0.1
Total		5841	100.0

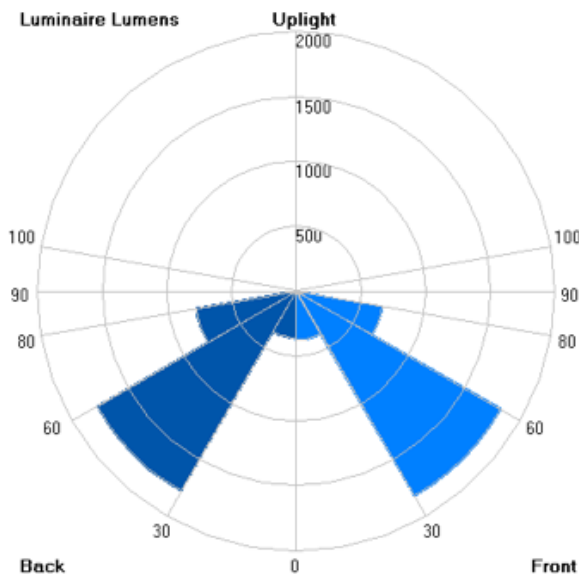

Content of specification sheet subject to change

LUMUX

POST TOP LIGHTING

PT600 - TYPE 5

DATE: _____

PROJECT: _____

FIRM: _____

CATALOG NO.: _____

COMMENTS: _____

Photometry	IESNA: LM-63-2002
TEST: n/a	TEST LAB: UL Lab
LUMINAIRE: PT600	DATE: 2016-10-22
IES Classification: VS	Long. Class: Very Short
Luminaire Lumens	5727 (4000K)
Luminaire Efficacy Rating (LER)	114
Total Luminaire Watts	50.1W
Upward Waste Light Ratio	0.00
Max. Candela	2489.527
Max. Cd. < 90° Vertical	2489.527
Max. Cd. (At 90 Deg. Vert.)	8.259 (0.1% Luminaire)
Max. Cd. (80 to <90 Deg. Vert.)	24.89 (0.4% Luminaire)
Cutoff Classification	Cutoff
BUG Rating	zero uplight

Technical aspects may change without notice.

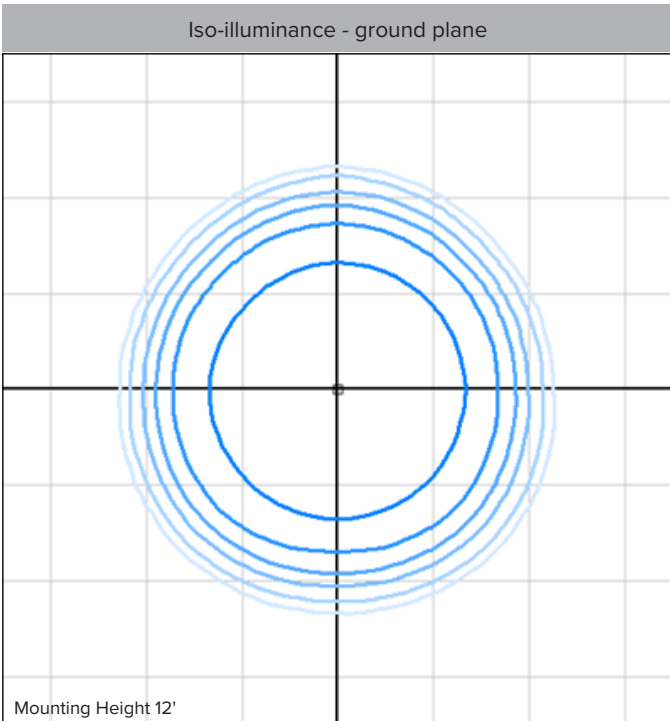

Foot-candles: 0.1, 0.2, 0.5, 1, 2, 5 | Grid spacing 10'

Sample isoillumiance plot. For actual values, use Lumux IES file with photometry software and correct surface reflectances.

Candela

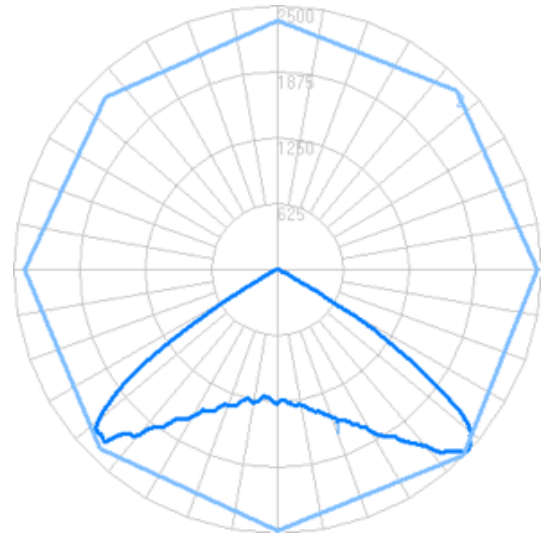

Coefficient of Utilization	Flux	%
Downward Street Side	2884.7	50.4
Downward House Side	2842.4	49.6
Downward Total	5727.1	100
Upward Street Side	0.0	0.0
Upward House Side	0.0	0.0
Upward Total	0.0	0.0
Total Flux	5727.1	100

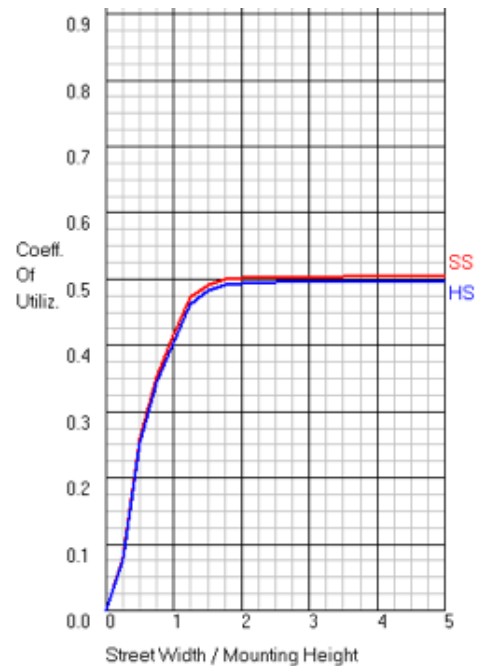

Content of specification sheet subject to change