



info@gtc.co.uk

UK Freephone: 0800 112 3919

International: +44 1202 801290

SolarTrack User Manual

Global Telesat Communication Ltd
19-25 Nuffield Road, Poole
Dorset, BH17 0RU

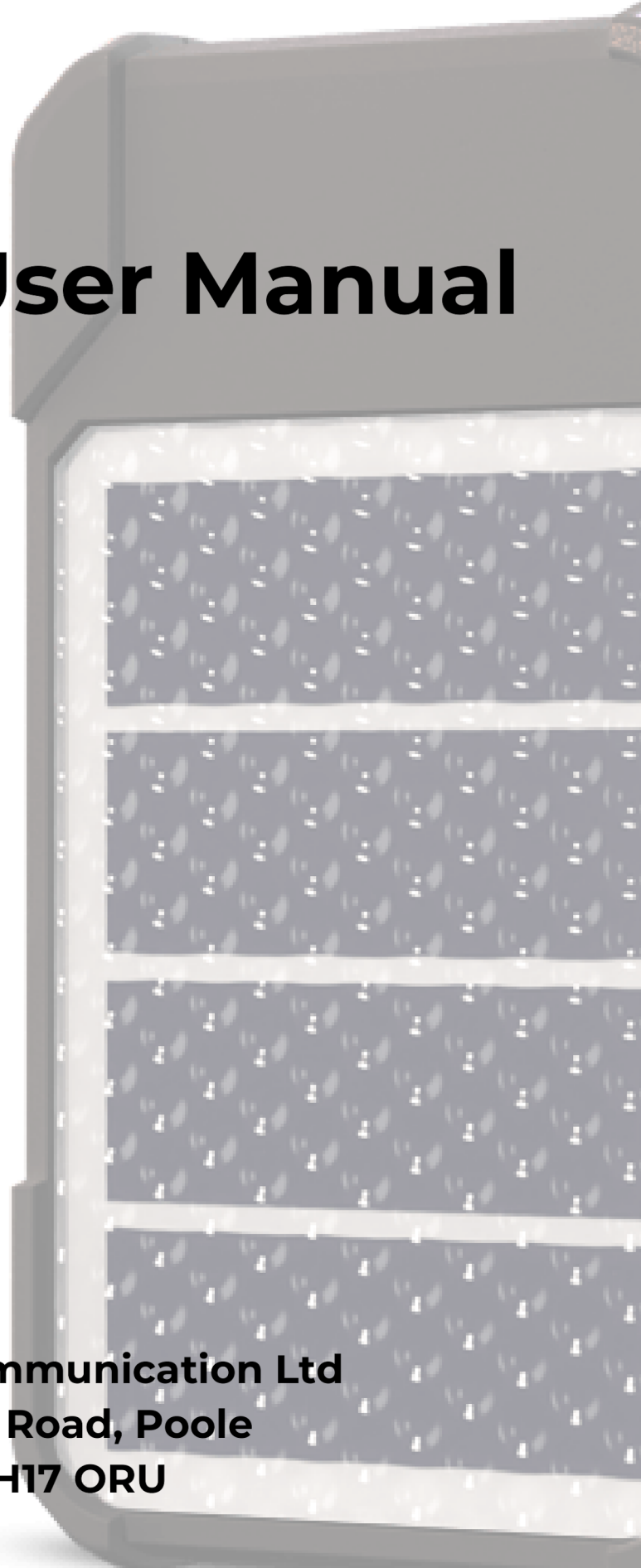

Introduction

Purpose

This document describes the physical, electrical, and functional characteristics of the SolarTrack Series satellite transmitter module with Bluetooth Low Energy.

The information contained in this document is intended to provide the customer with the necessary technical information required to configure and use the module.

Websites

www.gtc.co.uk/products/solartrack-satellite-asset-tracker
www.gtctrack.co.uk

Description

SolarTrack is a satellite transmitter designed to send GPS location data to a network of low earth orbiting (LEO) satellites.

The received data is then delivered to a telematics platform or other processor to visualise and utilise the data. The SolarTrack tracker is powered by a battery.

SolarTrack features a solar charging circuit that allows battery charging from the built in solar panel.

SolarTrack contains a satellite transmitter, GPS receiver, motion sensor, Bluetooth Low Energy transceiver, solar charger, and antennas for each of the radio subsystems.

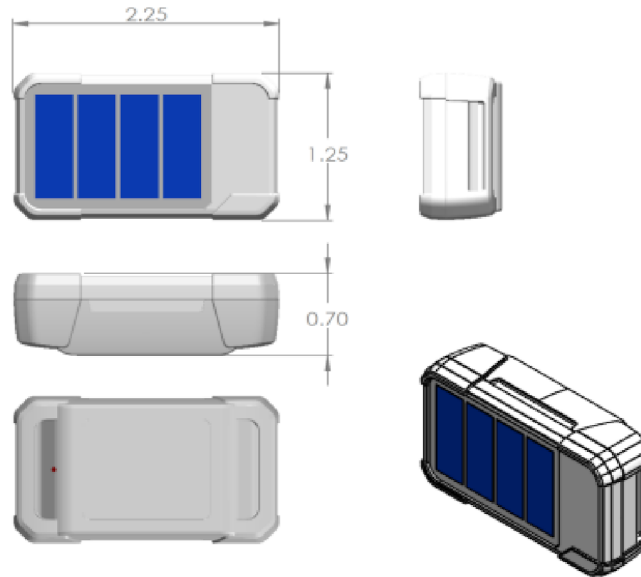
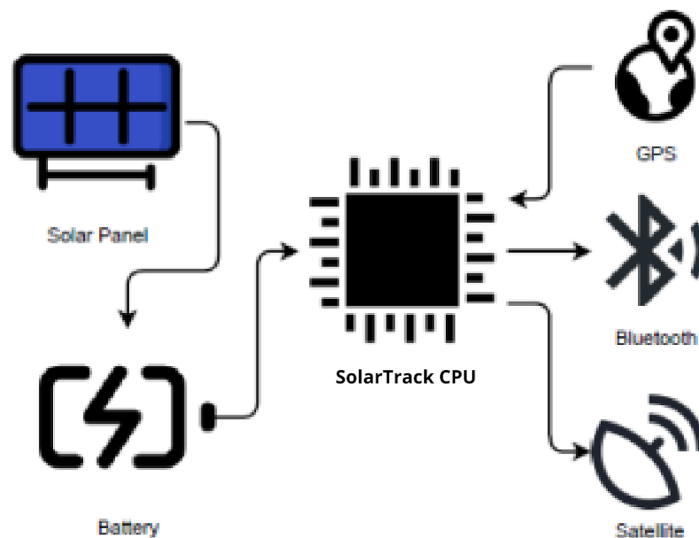

Figure - Physical Dimensions (inches)

Block Diagram



SolarTrack Best Performance

The SolarTrack determines its location by triangulation of GPS satellites, and then transmits the location back to a communications satellite. It is important to understand the application and importance of good satellite coverage, outdoor locations, and take into account obstructions, buildings, and metal objects that greatly affect the antenna performance. These devices are transmitting a signal up to 1,000 miles.

Even though they are small and lightweight with the latest silicon technology, they are still sensitive to positioning and orientation much more than say a cellular phone, which is transmitting up to a few miles.

Mounting Best Practices

Antenna Orientation

Care should be taken as to what is placed above, below, and around the SolarTrack. The internal satellite antenna is located inside the top edge of the SolarTrack. For best performance, the SolarTrack should have an unobstructed view of the sky. Metal objects next to or above the SolarTrack will greatly affect the performance of the device. Non-metallic substances such as fiberglass and plastic have less effect on the antenna performance.

Temperature

DO NOT MOUNT ON BLACK SURFACES. OVERHEATING RISK IS INCREASED

SolarTrack utilizes an internal lithium polymer battery, which is designed for operation between -10C and +60C. In direct tropical sunlight, the solar panel will also heat the unit by up to +15C from ambient temperature. In winter months, the additional heating caused by the solar panel will help increase the internal temperature of the unit, but in the desert, this can cause overheating and the unit will cease transmitting if the internal temperature exceeds these temperatures. The unit will resume operation once the temperature has dropped below the maximum operating temperature.

In general, do not mount on:

- Black surfaces
- Metal surfaces
- Poorly ventilated locations
- Car dashboards
- Enclosed locations that trap heat

Solar Panel

The orientation of the solar panel is important to consider, to ensure the device is mounted where direct sunlight will hit the solar panel. Placing the device under plastic or glass is not ideal, as different materials can block UV which is a large portion of the spectrum that the solar panel is most effective at converting to energy.

Noise Sources

Electrical noise is an important consideration in any installation of the SolarTrack. When possible, sufficient physical separation should be maintained between electrical noise sources and SolarTrack. Noise sources can be any other transmitter such as other satellite devices, GSM, WiFi, etc.

SolarTrack Mounting Options

Clip

The clip can be mounted to a surface with

- Screws
- Strap
- VHB
- Adhesive

To attach, press the SolarTrack into the clip until you hear a firm snap on both sides.

To detach, use the indent in the clip arms to release one side of the SolarTrack, then release the other side.

NOTE: The clip is designed to hold the SolarTrack very firmly. It will take significant force to remove the SolarTrack.

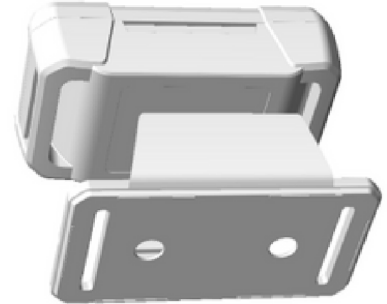

Strap

- Insert a nylon strap through the rails on the top and bottom side of SolarTrack as shown in the diagram.
- A second option is to use two nylon straps and use one nylon strap for each side in a U shape.

If you are using the strap design for an application that will exert a large amount of force on the strap, it is recommended to use a stronger strap and/or collar, and riveting the smaller strap to the larger strap to increase the strength.



Adhesive / VHB

NOTE: Using adhesive on the rear of the SolarTrack can damage the QR code and/or other information printed on the back of the case. It is recommended to take a picture of the rear of the unit prior to applying an adhesive.

- Prepare the surface of the SolarTrack, and the mounting surface, by cleaning with isopropyl alcohol.
- Use 3M VHB tape to adhere the unit to a surface OR use an adhesive appropriate for your application

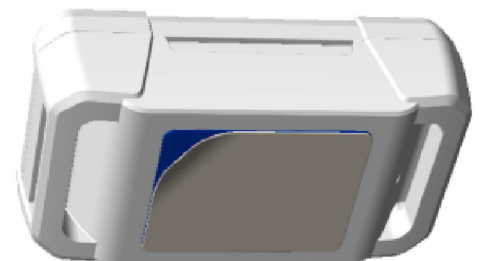

SolarTrack Mounting Options

Ear Tag

NOTE: The Crimping Tool is not included with the Ear Tag kit. The crimping tool (Allflex Universal Total Tagger or compatible) can be purchased locally or via online shops readily.

NOTE: The Male Pin is not included with the Ear Tag kit. The male pin can be used from any compatible tag and is considered consumable. To move the tag between animals, cut the male pin and replace it with a new male pin.

Components of the ear tag

1. Male Pin: Pin for piercing the ear
2. Mounting Strap
3. Female Socket: Must be mounted in Mounting Strap #2

Tools necessary for installation

1. Crimping Tool
2. Allflex Universal Total Tagger
 - a. Most universal taggers will work
3. SolarTrack
4. SolarTrack Ear Tag Mount (3 parts)



Installation Instructions

NOTE: Application site must be free of foreign debris prior to placement of tags on the animal. Free Air Space is critical for proper healing and retention. Inspect placement after tagging to ensure there is sufficient space between the ear and the tag.

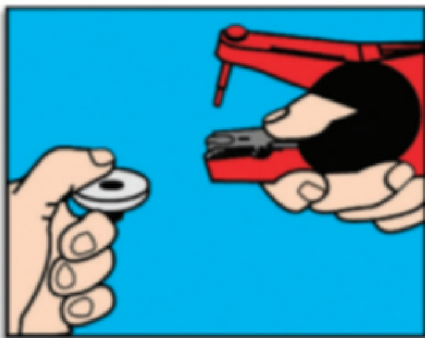

To load, depress the spring clip and insert the female tag. Ensure that the raised portion of the tag is placed in the open portion of the jaws.



Slip the male tag completely onto the blunt applicator pin. Squeeze the jaws together lightly to ensure the male shaft is in line with the female portion.



Dip the jaws of the applicator holding the tag into an antiseptic or disinfectant solution.



The tag should be placed vertically, in the middle of the ear, between the two cartilage ribs and 2/3 from the outside edge of the ear, 1/3 from the head. (Application too deep in the ear is not recommended).



The female portion of the tag should be on the outside of the ear with a tag application.

Strap/Collar

- Insert a nylon strap through the rails on the top and bottom side of SolarTrack as shown in the diagram.
- A second option is to use two nylon straps and use one nylon strap for each side in a U shape.

If you are using the strap design for an application that will exert a large amount of force on the strap, it is recommended to use a stronger strap and/or collar, and riveting the smaller strap to the larger strap to increase the strength.

Identification Features

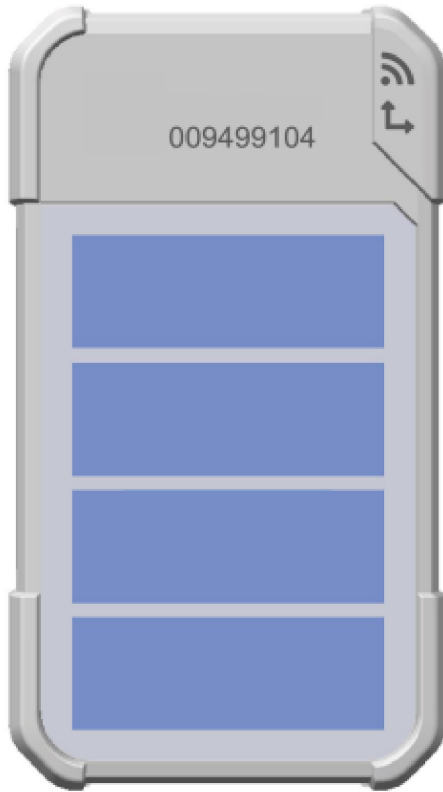

Front

ID: Printed on the front of the unit is a 9 digit number. The ID advertised on Bluetooth will be this ID without the leading zeros.



Rear

QR Code: Printed on the rear of the unit is a 9 digit QR code which represents the ID of the unit. This code can be scanned by mobile apps or any 2D scanners for quick identification.

Theory Of Operation

The SolarTrack operates on the Globalstar LEO satellite network. LEO (Low Earth Orbit) means that there are a number of satellites in low earth orbit that constantly orbit the planet and can communicate with devices that are within range of its current position.

Because the satellite position is constantly changing, commercial IoT devices on the ground will transmit (with no knowledge of any of the satellites locations) and the transmission may be received by one or more satellites. These satellites will then relay the message to the nearest satellite gateway. Once received by the satellite gateway, the message will be delivered to the gateway where redundant messages are discarded and the data from the message is sent to the telematics platform.

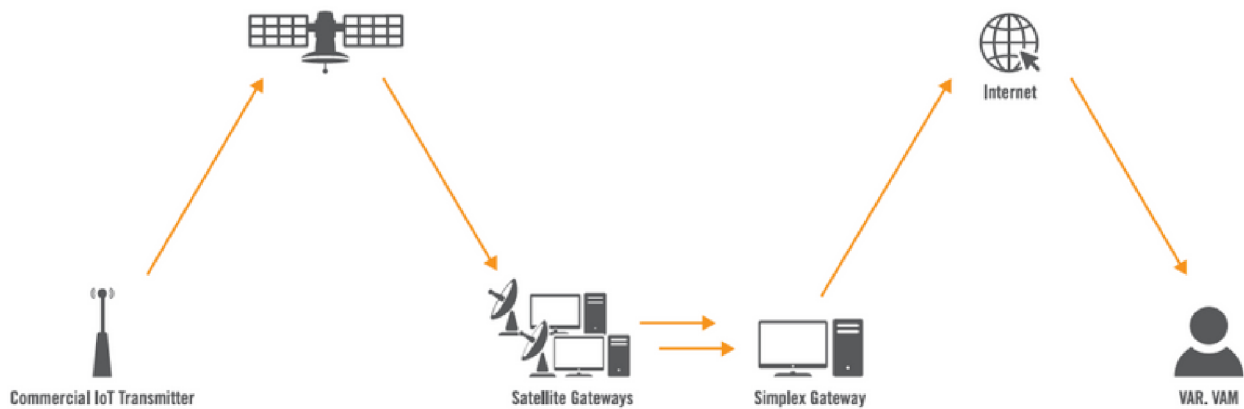
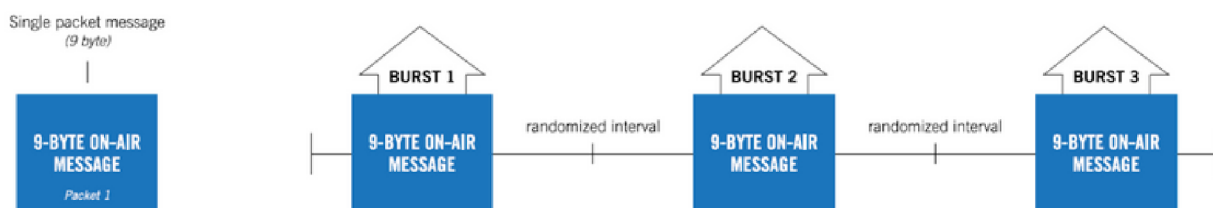

FIGURE - IoT MESSAGING

There are brief periods of time where there is no satellite in range of the commercial IoT transmitters due to obstructions and/or satellite coverage geometry. Since the SolarTrack has no way of knowing if a transmitted message has been successfully received, the SolarTrack is designed to send multiple (redundant) transmissions for each message sent.

The number of redundant transmissions per message is 3. This means that each message sent by the SolarTrack will be transmitted 3 times. Each transmission will contain the exact same data payload. The redundant transmissions of each message will be sent on a randomized interval with a configurable maximum and minimum duration. The default re-transmission configuration occurs between 5 to 10 minutes apart for each even randomized distribution. The transmission sequence for a single-packet message using 3 redundant transmissions is shown below.



For normal conditions where the transmitter has an open view of the sky, this will result in a better than 99% chance that the message will be received.

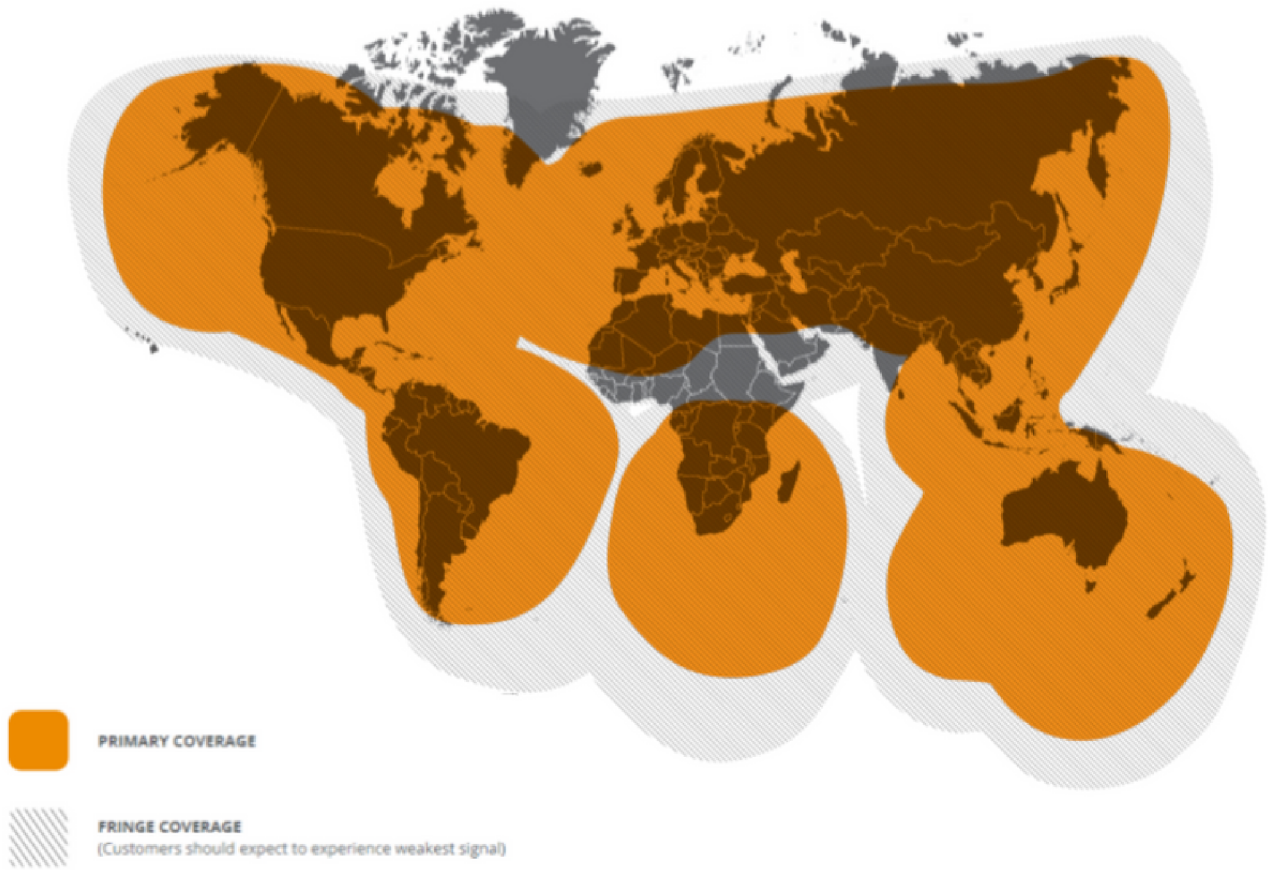

FIGURE - Simplex Coverage

Functional States

Over the SolarTrack's lifetime, it transitions through the following states.

Pre Operational State

Note that these states are defined by events that have occurred prior to the device becoming fully operational.

- **Configuration Mode:** This describes the state in which the unit is shipped. No operational profile and no lifetime have been programmed into it. The unit's solar panel has not been uncovered and the battery has not been allowed to charge. The VAR transitions the unit to be staged for activation mode by setting a lifetime and a profile into the unit, as described in the section below.
- **Staged for Activation:** The device is considered to be in staged for activation mode when the following things have been programmed.
 - **Device Lifetime:** This is automatically selected at the time of activation based on the device and airtime plan selected
 - **Reporting Rate / Profile:** This is set using the activation portal and selection of an airtime plan, which subsequently is used to set and sync a profile to the device.
 - **Low battery report rate:** This is the report rate the SolarTrack drops to when the internal battery voltage is low (below 3.6 volts). The default is 24 hours (one transmission per day).

Activating Mode

After the unit has switched to "Staged for Activation" mode, the unit enters the "Activating" mode when it detects that the unit is in sunlight and the battery is charging which is defined as a positive current flow into the battery for 5 consecutive minutes.

NOTE: A minimum amount of sunlight may be required for the solar panel to begin charging the battery, in order to enter the activating mode. If sunlight is not available (cloudy day), the device can be commanded to enter the activating mode via the mobile application.

Once charging of the battery is detected, the unit will attempt to obtain a GPS fix. If the fix is not obtained within the GPS timeout, the unit will sleep for 5 minutes and try again. This cycle will continue until a fix is successfully obtained. This cycle will "pause" if the battery level drops below 3.4 volts and resume after it has had some time to charge

NOTE: If charging for 5 consecutive minutes is detected, the likelihood is extremely high that the unit is outside, and the GPS fix will be obtained on the first attempt. The retry cycle is an edge case exception in operation.

Once the unit obtains a GPS fix, it calculates its expiration date, based on the lifetime previously programmed, and enters operational mode.

Operational Modes

These are the modes the unit may be in after completing the "activating mode" described above.

- **Normal operation:** Battery above 3.6 volts. The unit is in normal operation executing its track profile.
- **Low battery operation:** Battery between 3.6 and 3.4 volts. The unit will execute a track profile, but at the reduced "low battery" rate.
- **Extreme low battery suspend:** Battery below 3.4 volts. The unit will completely suspend operation, entering a "hibernate" state to allow the battery to charge.

Tracking Modes

The SolarTrack series supports 3 tracking modes, which are detailed below.

Accelerometer: the SolarTrack contains a built in accelerometer which can be used to detect motion to trigger position transmissions instead of a timer based transmission cycle.

Standard Tracking

Tracking reports are simply sent based on the defined interval between position transmissions. This mode does not use the accelerometer. The exact timing of transmissions are purposely somewhat randomized to guarantee successful transmission slots to the satellite network therefore over the lifetime of a unit, you will see the exact transmission time shift slightly per transmission.

Standard Motion Tracking

In this mode, tracking reports are not sent when the device is not moving, and when the device is moving, tracking reports are sent based on the programmed reporting rate. The expected behavior is to receive no data if the device is not moving, except for the health reports.

Dock Mode Motion Tracking

NOTE: This mode is not recommended for most applications as it consumes significantly more battery power vs simply increasing the reporting rate of the device. Please discuss with your account manager prior to utilizing this mode to verify it fits your application.

To combine intelligent motion based tracking with reduced position transmissions, this mode is ideal for assets that move while stationary. For example, a docked vessel on water will trigger the motion based tracking interval, but the vessel has not actually moved. This mode enables the GPS when motion is detected to verify whether the asset has actually moved, prior to transmitting. When multiple track points with similar GPS coordinates are detected, tracking will go into standby mode. While in standby mode the SolarTrack will not send track messages, but it will continue to attain your GPS coordinates at the same rate as your track mode. Once the SolarTrack has determined movement over a 200m distance, tracking will resume normally.

Location Transmission Behavior

If the reporting interval is set to 30 minutes or greater, a redundant burst transmission will be initiated at each interval, with the number of attempts and the timing between the attempts as specified by the reporting rate. With an interval of 30 minutes or less, the GPS will retain its clock and ephemeris* data in order to perform a “hot” GPS fix. This will increase the GPS standby current to the “GPS Standby Mode” value in the table below. For tracking intervals greater than 30 minutes, the GPS will be powered off in between transmissions and the sleep current will be the “Standby Mode” value.

If the interval is 40 minutes or greater, the SolarTrack will randomize the start of each burst by +/- 10 minutes around the nominal. For example, if a track mode with an interval of 1 hour is started at 12:00, the next burst position report will begin randomly between 12:50 and 1:10, the one after that will begin between 1:50 and 2:10, etc.

If the SolarTrack is in a motion detection mode, the accelerometer will remain powered during the standby periods in between transmissions and the accelerometer standby current will be the “Standby mode supply current w/Accelerometer” value. The following table summarizes the standby mode supply current for different modes.

Table: Operating Modes and Standby Current

Operating Mode	Standby Current
Continuous Tracking <= 30 minute interval	GPS Standby Mode + Standby mode supply current w/Accelerometer
Continuous Tracking > 30 minute interval	Standby mode supply current w/Accelerometer
Motion Activated Tracking <= 30 minute interval	GPS Standby Mode + Standby mode supply current w/Accelerometer
Motion Activated Tracking > 30 minute interval	Standby mode supply current w/Accelerometer

*Ephemeris: a tabular statement of the assigned places of a celestial body for regular intervals.

Health Status Message

The Health Status Message reports the current settings and condition of the device. The message generation interval is configurable from 1-30 days, with a default interval of 30 days. One message per month is generated at no charge, shorter intervals are charged according to the device plan.

NOTE: One message per month minimum, cannot be set to zero. The device health check message length is 2 packets (18 bytes).

Health Status Message Content

- Number of Bursts per Message
- Battery Condition: Battery OK / Battery LOW
- GPS Status: GPS system OK / Fault
- Transmitter Status: Transmitter OK / Fault
- FW Version: Major FW / Minor FW / Patch FW Version
- Number of GPS Fails: Count of failed GPS attempts since last health message
- Number of Transmissions: Number of transmissions since last health message
- Mean GPS Fix Time: Mean time to get a GPS Fix since last health message
- Board Status: Board not reset since last health message / Board was reset since last health message

End Of Service

All SolarTracks are programmed with an end of service date to account for the expected life of the unit, and to ensure devices do not transmit after the end of their service plans. If your application needs a different lifetime, please contact your account manager to discuss. The end of service cannot be adjusted over the air, it must be performed locally via Bluetooth with the tag nearby.

When the unit auto activates, it calculates an end date based on its programmed lifetime. For example, if the lifetime is 3 years (36 months) and it activates on October 24, 2020, the expiration date will be October 24, 2023.

Each time the unit obtains a GPS fix, it checks the calendar date. If the date is past the expiration date (in this example, October 25, 2023) it immediately drops out of track mode and enters the end of service mode.

Once the unit has entered end of service mode, it will respond over a local Bluetooth connection to simple queries, such as a query for its version number or tracking state (which will be "none"), but it will NAK any command that might cause it to transmit over the Globalstar network.

Technical Specifications

Certifications

Our products comply with WEEE and RoHS. The SolarTrack has the following certifications:

- Bluetooth LE
- FCC

Overview

- SolarTrack temperature range -20 to +65°C
- SolarTrack functional temperature range -20 to +65°C
- Battery charging temperature range -10 to +55°C
- Standby current: 30-40uA
- Battery current drain
- Standby current: 30-40uA
- GPS on current: 50-60mA
- Transmitter on current: 500mA max @ 3.7V
- Satellite RF output: +24.5dBm
- Supported Frequencies: 1611.25MHz, 1616.25MHz, or 1618.75MHz
- GPS/Satellite antenna gain +1.06 dBi
- Bluetooth Low Energy (BLE): 0dBm TX power / -69dBm RX sensitivity Bluetooth antenna gain: -1.09 dBi

Battery Specifications

The SolarTrack is configured at the factory to cut off charging at temperatures below -10°C and above 65°C.

- Battery Chemistry: Lithium Polymer
- Battery Capacity: 153mAh
- Battery Lithium Content: 0.054 grams

Battery Specifications	Min	Typical	Max	Unit
Rated Capacity @ 4.2V		153		mAH
Normal Voltage		3.7		V
Maximum Charge Voltage		4.2		V
Maximum Discharge Voltage		3.0		V
Charging Current - Standard Charge		0.2		C
Charging Current - Rapid Charge		1.0		C
Charging Time - Standard Charge	5.5		6.5	hours
Charging Time - Rapid Charge	1.5		2.5	hours

Maximum Charging Current		1.0		°C
Discharge Temperature - Standard Discharge @ 0.2C	-20			°C
Discharge Temperature - Rapid Discharge @ 1.0C	-20			m
Cell Impedance (4.2V AC @ 1khz)	-20			mOh m
Cell Dimensions	(depth 4.0)	(width) 14.0	(height) 30.0	mm

Solar Panel Performance

Solar panels will generate about 10 to 25% of their normal power output on a cloudy day
Solar panels not oriented towards the sun will generate significantly less power. Orientation of the solar panel towards the sky will greatly increase reliable reporting rates during poor weather conditions or other obstructions during the lifetime of the unit.

Solar Panel Power: 125 mW

Charging Time:

- 5 hours of direct sunlight to fully charge from a dead battery
- 3 hours of direct daily sunlight to keep fully charged at 30 minute reporting rate

Battery Performance

The ST100 battery performance heavily depends on the amount of GPS and Satellite Transmitter usage. Below are some examples of battery performance for select battery sizes and track modes.

Reporting Rate	Expected Battery Life (without charging the battery)
30 minute	1.5 days
60 minute	3 days
240 minute	10 days
720 minute	19 days
1440 minute	28 days

NOTE: The data gathered above represents messages with a size of 1 data packet.

GPS Performance

Chipset: ZOE-M8

Receiver type: 72-channel

- GPS/QZSS L1 C/A
- GLONASS L10F
- BeiDou B1I
- Galileo E1B/C

SBAS L1 C/A: WAAS, EGNOS, MSAS, GAGAN

Accuracy: 2.0 m CEP

Acquisition

- Cold starts: 26s
- Aided starts: 2s
- Reacquisition: 1s

Sensitivity

- Tracking & Nav: -167 dBm
- Cold starts: -148 dBm
- Hot starts: -157 dBm

Anti jamming

Active CW detection and removal

Onboard SAW band pass filter

Flash Memory

The SolarTrack utilizes internal flash to log position data over the life of the unit. The following specs detail the storage capacity.

Depending on the reporting rate of the unit, you can formulate how many positions are stored onboard the device for logging.

Location Logging

- Size of each data element: 12 Bytes (3 for Lat, 3 for Long , 4 for Timestamp & 2 bytes padding)
- Total number of data elements: 8.4 (years) * 365 (days) * 4 (Tx per day) = 12276 data points

To determine how many days of locations are logged to the unit, use the following formula:

- $12276 / (\text{reports per day}) = (\text{number of days logging})$

Other Specifications

Harmonized Code: 8526.91.0040

General Warnings

- **WARNING – Modifications:** Changes or modifications to the SolarTrack not expressly approved by the party responsible for compliance could void the user's authority to operate the equipment.
- **WARNING – Blasting Area:** To avoid interference with blasting operations, turn your SolarTrack off when in a "Blasting Area" or in areas posted "Turn off two-way radio." Obey all signs and instructions.
- **WARNING – Potential Explosive Atmosphere:** Turn off the SolarTrack or any product with the SolarTrack installed when in any area with a potentially explosive atmosphere and obey all signs and instructions.
- **WARNING – Pacemakers:** The Health Industry Manufacturers Association recommends that a minimum separation of six (6") inches be maintained between the SolarTrack and a pacemaker to avoid potential interference with the pacemaker.
- **WARNING – Hearing Aids:** Some digital wireless devices may interfere with some hearing aids. In order to prevent such interference, you may want to consult the manufacturer of your hearing aid.
- **WARNING – Specific Absorption Rate (SAR):**

FCC / Canada: The SolarTrack has been shown to be compliant to localized Specific Absorption Rate (SAR) for uncontrolled environment/ general exposure limits specified in ANSI/IEEE STD C95.1-1992 and has been tested in accordance with measurement procedure specified in IEEE 1528-2013 and IEC 62209-2:2010 using a separation distance of 20 cm.

European Union (CE RED): The SolarTrack has been shown to be compliant for localized specific absorption rate (SAR) for uncontrolled environment / general exposure limits specified in ANSI/IEEE Std. C95.1-1999 and has been tested in accordance with the measurement procedures specified in EN50566:2017 and EN62209-2:2010 using a separation distance of 20 cm.

NOTE: If concerned about RF exposure during use, place the SolarTrack away from your body. The RF exposure level drops off dramatically with distance from the SolarTrack antenna.

Regulatory

Radio Astronomy Site Avoidance

The SolarTrack complies with FCC CFR25.213. The customer end-product must comply with the requirements for Radio Astronomy avoidance. See Globalstar document GS-07-1248 REMOTE TELEMETRY SERVICE FREQUENCY PLAN FOR SIMPLEX TRANSMITTERS for more details.

Regulatory Notices

The SolarTrack Series has received Federal Communications Commission authorization under FCC Rules Part 25 and Part 15C as a modular transmitter. Final installation must be in compliance with 25.213 (see above). The installation and operating configurations of this transmitter must satisfy MPE categorical Exclusion Requirements of 2.1091. The antenna used for this transmitter must be installed to provide a separation distance of at least 20 cm from all persons and must not be collocated or operating in conjunction with any other antenna or transmitter.

The SolarTrack transmitter is only FCC authorized for the specific rule parts (i.e., FCC transmitter rules) listed on the grant.

NOTE: Any additional host device the module is integrated into will require regulatory testing and certification (C2PC for FCC and C4PC for ISED**).

The SolarTrack module has been labeled with its FCC ID numbers as follows:

Contains Transmitter Module FCC ID: L2V-ST100 IC: 3989AST100. This device complies with Part 15 of the FCC Rules. Operation is subject to the following two conditions: (1) this device may not cause harmful interference, and (2) this device must accept any interference received, including interference that may cause undesired operation.

Additional Notices

This equipment has been tested and found to comply with the limits for a Class B digital device, pursuant to part 15 of the FCC Rules. These limits are designed to provide reasonable protection against harmful interference in a residential installation. This equipment generates, uses and can radiate radio frequency energy, and if not installed and used in accordance with the instructions, may cause harmful interference to radio communications. However, there is no guarantee that interference will not occur in a particular installation. If this equipment does cause harmful interference to radio or television reception, which can be determined by turning the equipment OFF and ON, the user is encouraged to try to correct the interference by one or more of the following measures:

- Reorient or relocate the receiving antenna.
- Increase the separation between the equipment and receiver.
- Connect the equipment into an outlet on a circuit different from that to which the receiver is connected.
- Consult the dealer or an experienced radio/TV technician for help.

WARNING: Changes or modifications not expressly approved by Globalstar may render the device noncompliant to FCC and other regulatory body standards for operation and may void the user's authority to operate the equipment.

This device complies with Part 15 of the FCC Rules. Operation is subject to the following two conditions: (1) This device may not cause harmful interference, and (2) this device must accept any interference received, including interference that may cause undesired operation.

**ISED is an acronym for Innovation, Science and Economic Development (Canada).

This Class B digital apparatus complies with Canadian ICES-003.

Cet appareil numérique de classe B est conforme à la norme NMB-003.

Hereby, Global Telesat Communications declares that this SolarTrack is in compliance with the essential requirements and other relevant provisions of Directive 2014/53/EU. The declaration of conformity may be consulted at www.Globalstar.com/Regulatory.

NOTICE: This equipment complies with FCC, IC and CE RF Exposure Limits. A minimum of 20 centimeters (8 inches) separation between the device and the user and all other persons should be maintained.

AVIS: Cet équipement est conforme aux RSS-102 Limites d'exposition RF. Un minimum de 20 centimètres (8 pouces) entre l'appareil et l'utilisateur et toutes les autres personnes devrait être maintenue.

Transmit Frequencies: 1611.25 Mhz - 1618.75 Mhz (4 Channels) Max Power Out: 25.82 dBm EIRP

FCC ID: L2V-ST100

CAN ICES-3(B)/NMB-3B

IC: 3989A-ST100

Complies with FCC standards.

FOR HOME OR OFFICE USE

The SolarTrack Series has been so constructed that the product complies with the requirement of Article 10(2) as it can be operated in at least one Member State as examined and the product is compliant with Article 10(10) as it has no restrictions on being put into service in all of the EU except Ireland. The SolarTrack Series cannot be marketed in Ireland.

Appendix A

Acronym List

ACK: Acknowledgement	NMEA: National Marine Electronics Association
APP: Application	OEM: Original Equipment Manufacturer
ASCII: American Standard Code for Information Interchange	OTA: Over the Air
ASIC: Application-Specific Integrated Circuit	PCB: Printed Circuit Board
BLE: Bluetooth Low Energy	PLL: Phase-Locked Loop
C: Celsius	POST: Power-On Self-Test
CE RED: Conformité Européene Radio Equipment Directive (Europe)	RF: Radio Frequency
CPU: Central Processing Unit	RoHS: Restriction of Hazardous Substances
CRC: Cyclic Redundancy Check	RTU: Remote Transmitter Unit
dBm: Decibel-Milliwatts	RX: Receive
DC: Direct Current	SAR: Specific Absorption Rate
DFU: Device Firmware Update	SCL: Serial Clock
EIRP: Effective, or Equivalent, Isotropically Radiated Power	SDA: Serial Data
ESD: Electrostatic Discharge	SDK: Software Development Kit
ESN: Electronic Serial Number	SMA: Subminiature Version A
F: Fahrenheit	STU: Satellite Transmitter Unit
FCC: Federal Communications Commission	TX: Transmit
FTP: File Transfer Protocol	UART: Universal Asynchronous Receiver/Transmitter
GATT: Generic Attribute Profile	V: Volts
GLONASS: Global Navigation Satellite System	VAM: Value Added Manufacturer
GND: Ground	VAR: Value Added Reseller
GPIO: General-Purpose Input/Output	VDC: Voltage Direct Current
GPS: Global Positioning System	VNA: Vector Network Analyzer
HTTP: Hypertext Transfer Protocol	WEEE: Waste Electrical & Electronic Equipment (Europe)
HW: Hardware	
I2C: Inter-Integrated Circuit	
IC: Industry Canada	
iOS: iPhone Operating System	
ISED: Innovation, Science and Economic Development (Canada)	
JTAG: Joint Test Action Group	
LEO: Low Earth Orbiting	
mA: Milliamps	
mAh: Milliamp Hour	
mm: millimeter	
mW: milliwatt	
N/A: Not Applicable	
NAK: Negative-Acknowledgement	



info@gtc.co.uk

UK Freephone: 0800 112 3919
International: +44 1202 801290

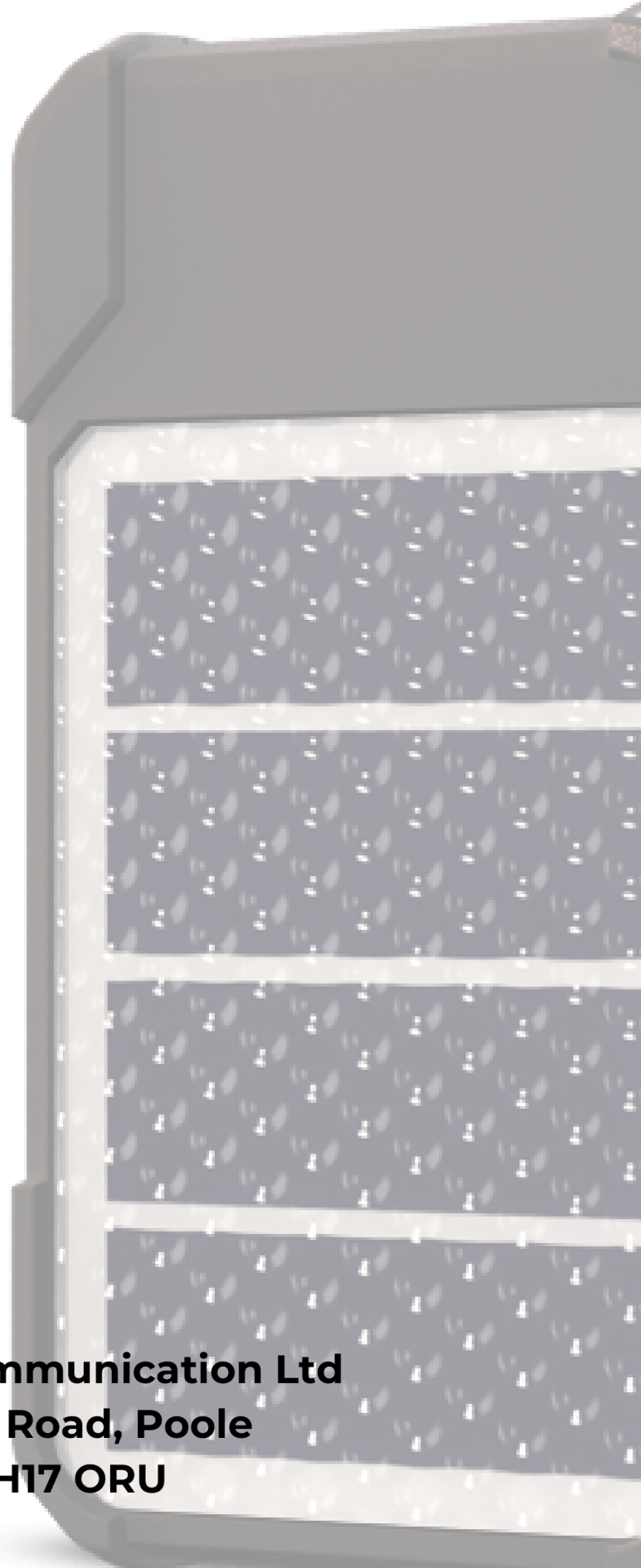

Global Telesat Communication Ltd
19-25 Nuffield Road, Poole
Dorset, BH17 0RU