

버디두기 라이더 콜리 애견유모차  
BUDDY DUGGY RIDER COLLY PET STROLLER WAGON

# RIDER COLLY

UPTO  
**30KG**  
66lbs

Make Way! We're Strolling

RIDER COLLY for multiple and mid to large size pets

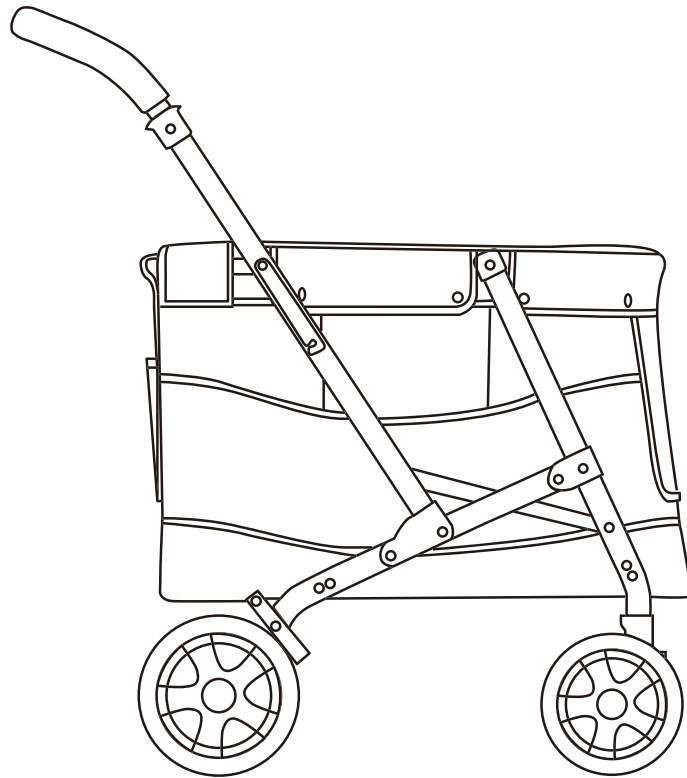

**bd**  
BUDDY  
DUGGY

# 버디두기 라이더 콜리 강아지 유모차 조립 및 사용 방법

## 1 프레임 펼치는 방법

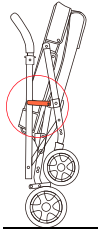

고정 후크를 풀어 주세요(고리)

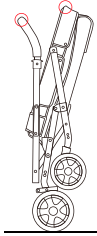

한 손으로 핸들을 잡고 다른 손으로 바꾸니 앞 부분을 잡아주세요

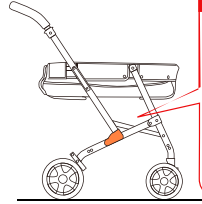

핸들을 잡고 조심스럽게 누르며 완전히 펼쳐 주세요



## 2 사용 전 조립 방법

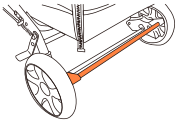

먼저 뒷바퀴를 고정해 주세요  
· 평평한 곳에서 고정하세요  
· 고정되었는지 확인해주세요

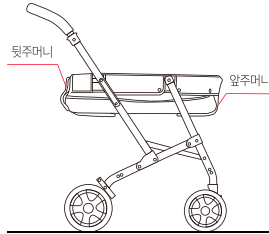

시트에 부착된 앞 주머니와 뒷주머니를 풀어 주세요

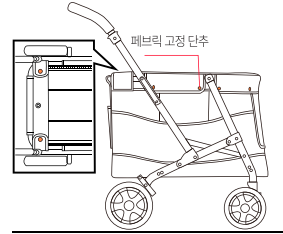

페브릭 고정 단추 잘 잠겼는지 확인해주세요

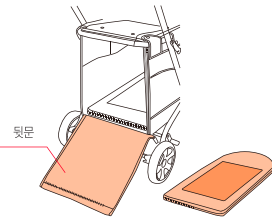

내부에 있는 쿠션을 먼저 제거한 후 뒷문을 밖으로 빼 주세요  
뒷문에 달린 지퍼를 이용해 닫아 주세요

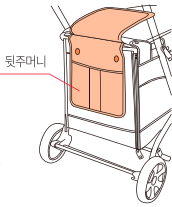

뒷문과 뒷주머니를 단추를 이용해 고정해 주세요

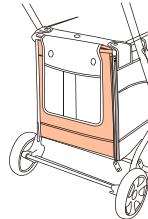

후면 양쪽에 위치한 지퍼를 상단으로 당겨 뒷문을 잠가 주세요

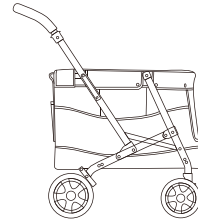

유모차가 완성되었습니다

- 주의**
- 바퀴와 프레임이 잘 고정되었는지 확인해주세요
  - 프레임에 시트 패브릭이 잘 고정되었는지 확인해 주세요
  - 뒷문의 지퍼가 끝까지 잘 잠겼는지 확인해주세요
  - 반려동물을 태우기 전 유모차 브레이크(뒷바퀴)를 고정해주세요

### 3 뒷문(계단) 사용 방법

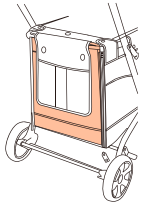

뒷바퀴 브레이크를 먼저 잠가주세요



뒷문에 고정된 뒷주머니 스타랩을 분리해 주세요  
· 뒷문의 양쪽 지퍼를 끝까지 내려 주세요  
· 뒷면에 위치한 지퍼를 끝까지 열어 주세요

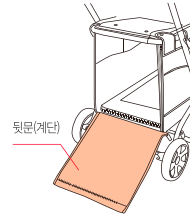

뒷문을 밖으로 당겨 열면 반려동물의 계단으로 사용할 수 있습니다  
· 주의 : 계단으로 사용할 때 뒷문이 바닥에 닿았는지 확인해주세요

### 4 시트 접는 방법

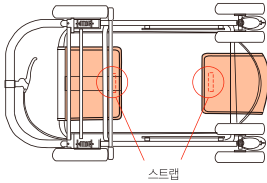

바구니 바닥에 있는 접착 스트랩을 펼쳐주세요

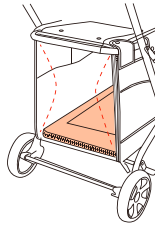

뒷문의 지퍼를 열어 뒷문을 시트 안으로 밀어 넣어 주세요

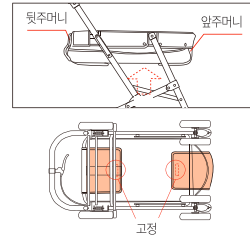

뒷주머니와 앞주머니를 시트 바닥의 접착 스트랩에 붙여 납작하게 고정해 주세요

### 5 프레임 접는 방법



양쪽의 폴딩 레버를 동시에 당기면서 핸들을 앞으로 들어올리듯 밀어주세요

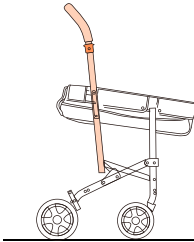

고정 후크를 걸어 주세요

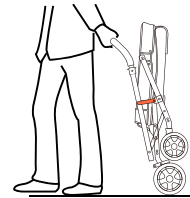
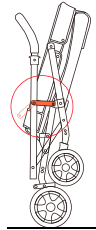

뒷바퀴의 브레이크를 풀면 쉽게 끌며 이동할 수 있습니다

### 6 패드 사용 방법

시트 안에 들어있는 쿠션은 시중에서 판매하는 패드를 넣고 사용할 수 있도록 만들었습니다  
지퍼를 이용해 대쉬 소재 아래에 패드를 넣어주세요

## 버디두기 라이더 콜리 강아지 유모차 조립 및 사용 방법

### 7 앞바퀴 사용법

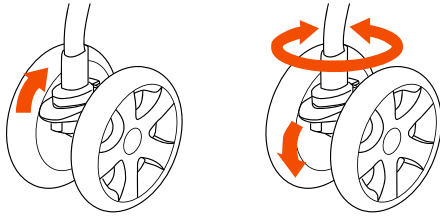

- 앞바퀴 고정장치를 위로 올리면 바퀴가 직진으로 고정되며 아래로 내리면 좌우로 자유롭게 움직임이 가능합니다
- 경사면이나 울퉁불퉁한 길에서는 양쪽 앞 바퀴의 고정장치를위로 올려 고정해주세요

### 8 뒷바퀴 브레이크 사용법

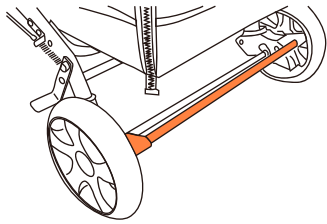

- 뒷바퀴 전체에 연결된 브레이크를 아래로 내리면 고정, 위로 올리면 브레이크 해제 됩니다
- 브레이크는 주행하는 경우를 제외하고 항상 고정해 주세요 반려동물이 유모차 안에 있을 때 보호자가 곁에서 지켜봐 주세요

### 9 사용 중 점검 방법

- 초기 핸드브레이크는 알맞게 조절이 되었지만 사용하지 않더라도 시간이 지남에 따라 기능이 저하될 수 있으니 사용 전 브레이크 패드와 뒷바퀴 사이의 간격을 확인해 조절하시기 바랍니다
- 타이어와 브레이크 와이어는 소모품입니다 뒷바퀴와 브레이크 작동과는 관련이 없습니다 외출 전 항상 브레이크를 점검하시고 균열이나 파손 등이 있는 경우 즉시 사용을 중지하고 새 바퀴로 교체해 주세요

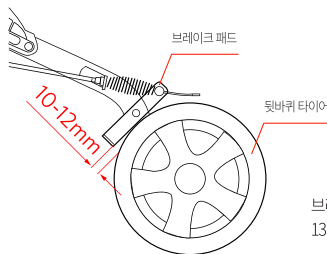

브레이크패드와 타이어 사이의 거리는 10-12mm가 적당합니다  
13mm 이상일 경우 브레이크를 조절해 주세요

## 10 브레이크 3가지 조절 방법

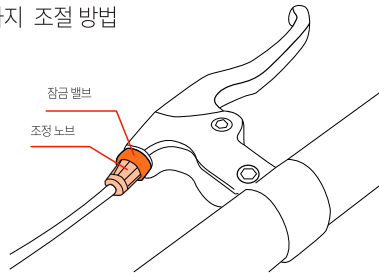

핸드 브레이크 손잡이 부분의 잠금 밸브를 풀고 조정노브를 원하는 간격으로 조정한 후 다시 잠금 밸브를 잠가 조절하세요

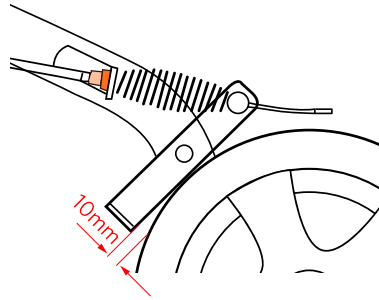

뒷바퀴 브레이크패드 부분의 잠금 밸브를 풀고 조정노브를 원하는 간격으로 조정한 후 다시 잠금밸브를 잠가 조절하세요

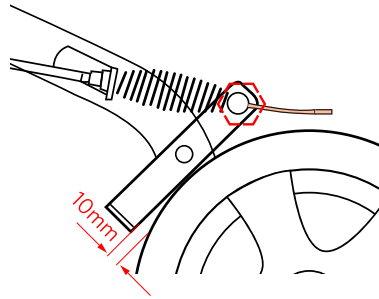

잠금밸브와 조정노브로 조절이 안될 경우 브레이크 패드에 연결된 브레이크 와이어를 재조정하여 조절해주세요

**주의** · 방법이 어려울 경우 자전거샵에서 브레이크 서비스를 받으실 것을 권장합니다  
· 휠(타이어) 교체가 필요할 경우 판매자를 통해 정품 구매 후 교체해 주세요

# BUDDYDUGGY 라이더 콜리 강아지 유모차 설명서

• 설명서의 제품 이미지는 실제 상품과 다소 차이가 있을 수 있으나 기능상의 문제가 아님을 알려드립니다

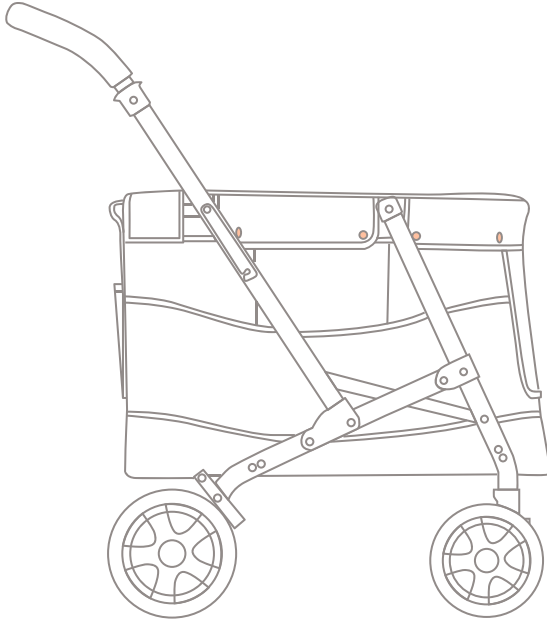

- 사용 권장 무게: ~30kg
- 제품 사이즈  
전체 사이즈: 58 x 89 x 97cm(h)  
시트 사이즈: 40 x 68 x 42cm(h)
- 소재: 스테인리스 스틸, 폴리에스터
- 제품무게: 11kg
- 원산지: 중국

**경고** · 이 제품은 반려동물을 위한 유모차입니다 다른 목적으로 사용하지 마세요  
· 본 제품의 주의사항을 숙지하지 않을 시 심각한 부상을 입을 수 있으니 주의사항과 사용방법을 숙지하여 주시기 바랍니다

안전사고 예방 및 원활한 사용을 위해 사용 전 반드시 설명서 내용을 숙지하시고 사용 중 참고할 수 있도록 보관해 주십시오

이 제품은 무게가 30KG 미만인 반려 (강아지 및 고양이) 동물을 위한 유모차입니다  
다른 목적으로 사용하지 마십시오.  
단, 반려동물의 행동 차이와 개별적인 차이로 인해 무게 제한이 다를 수 있습니다

안전한 사용을 위해 사용방법과 주의사항을 따라 주십시오  
고객 부주의로 인한 사고에 대해 본사는 책임을 지지 않습니다

• 사고나 부상 방지를 위해 설명서와 경고글을 읽어주세요

1. 사용 시 하네스가 유모차에 연결되었는지 확인하십시오
2. 반려 동물을 유모차 안에 오래 두지 마시고 혼자 두지 마십시오
3. 가파른 경사에서는 브레이크 기능이 저하될 수 있으니 주의하십시오
4. 유모차 폴딩 시 손발가락의 끼임 사고가 나지 않도록 주의하십시오
5. 유모차를 접을 때에는 반드시 반려동물이 없는 상태에서 접으십시오
6. 무거운 물품이나 신거나 사람을 태우지 마십시오
7. 유모차 손잡이에 무거운 짐이나 가방을 걸지 마십시오
8. 유모차를 경사로에 세워두지 마십시오
9. 주행 중에는 안전을 위해 메쉬 덮개를 덮고 사용하십시오
10. 사용 전 반드시 제품 부식이나 손상이 없는지 확인한 후 사용하십시오
11. 비포장 도로, 눈길, 빗길에서 브레이크 제동 능력이 떨어질 수 있으며 정지된 후에도 타이어가 미끄러져 사고가 발생할 수 있으니 주의해 주십시오
12. 핸드브레이크는 속도를 줄이거나 제동 능력을 돕기 위한 장치이며 완벽한 브레이크 용도로 사용되지 않음을 주의하여 주시기 바랍니다

• 반려 동물의 승하차 시에는 아래 3가지 사항을 확인하십시오

1. 탑승 중일 때 브레이크가 잠겨있다 하더라도 가파른 경사에서는 브레이크의 성능이 떨어질 수 있습니다
2. 접을 때 반려 동물이 끼일 수 있으니 주의하여 주십시오
3. 유모차에 시트가 올바르게 장착되었는지 확인하십시오

• 기타 주의 사항

1. 반려 동물의 예기치 않은 행동으로 인한 부상과 사고는 보상되지 않습니다
2. 제품을 과격하게 사용하거나 보관할 경우 손상되거나 부품이 빨리 마모될 수 있으니 주의하여 사용해 주십시오
3. 부적절한 수리 및 개조, 사용으로 인한 사고는 보상하지 않습니다.
4. 제품은 직사광선에 의해 변색될 수 있으니 직사광선이 없는 통풍이 잘되는 곳에 보관하십시오
5. 비가 오는 날씨는 제품이 노출되지 않도록 주의해 주십시오
6. 제품을 화기, 전기 불꽃근처에서 사용하지 마십시오
7. 불결한 상태로 보관할 경우 벼룩과 진드기 번식의 원인이 될 수 있으므로 청결하게 유지하고 청소해주시기 바랍니다
8. 유모차 상태를 양호하게 유지하려면 제품을 청결하게 사용하고 유지 관리에 주의를 기울여야 합니다
9. 유모차와 액세서리를 정기적으로 점검하여 손상 및 마모 징후가 있는지 확인하십시오
10. 금속 부품 모양이 변형되거나 균열이 있는지 확인하시고 문제가 있을 경우 사용을 중단하십시오
11. 플라스틱, 금속부품은 마른 수건으로 오염 부분을 닦아 주십시오
12. 연마제, 솔벤트, 암모니아 또는 표백제 같은 세척제는 사용하지 마십시오
13. 후드 및 시트는 깨끗한 천을 이용해 부드럽게 닦은 후 완전 건조시켜 주십시오
14. 시트나 바구니를 포함해 세탁기 또는 건조기를 사용하지 마십시오
15. 브레이크와 바퀴는 소모성 부품이므로 마모 시 교체해야 합니다
16. 바퀴나 프레임에 무리하게 힘을 가하지 마시고 문제가 의심될 경우 지침을 확인해 주십시오
17. buddyduggy에서 공급하거나 권장하는 정식 부품만 사용하십시오
18. 바퀴 등 구동부에서 소리가 나면 WD-40스프레이나 실리콘 윤활제를 적당히 사용하십시오  
오일이나 그리스가 첨가된 제품은 사용하지 마십시오
19. 정기적인 점검은 유모차의 수명을 연장시킵니다

# BUDDY DUGGY RIDER COLLY PET STROLLER WAGON ASSEMBLY MANUAL

## 1 Opening the frame

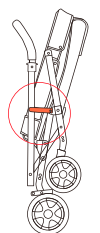

Release lock (hook)

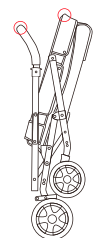

With one hand hold onto the handle

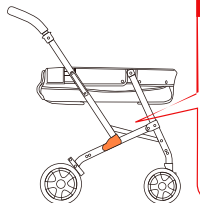

Gently press while holding onto the handle and unfold the stroller wagon

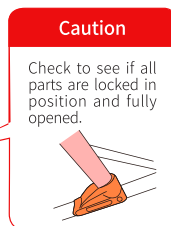

## 2 Assembly before usage

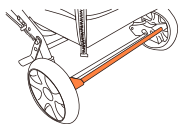

- First check to see if wheels are in the correct position.  
- Assemble on a flat surface  
- Check to see if it is assembled properly.

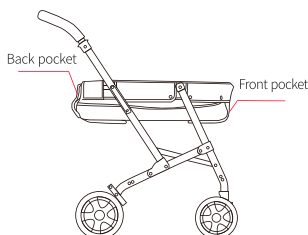

Detach the front and back pockets attached to the seat.

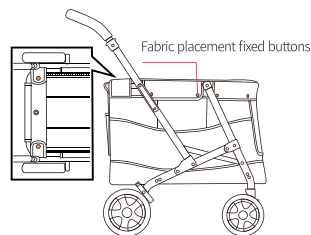

Check to see that the fabric placement fixed buttons are all secure and attached.

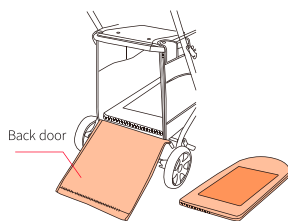

- Remove the internal cabin cushion and pull out the exterior back door ramp. Use the zipper on the outside to close fully.

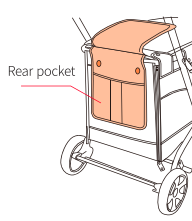

Use the outer door + pocket closure to secure.

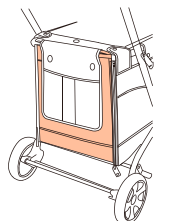

Locate the outer zippers located in the back and zip upwards

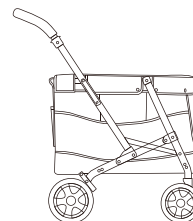

The stroller is fully assembled

### Caution

Rider Colly Pet Stroller Wagon is for PETS ONLY.

- Make sure that wheels and frame are properly assembled.
- Make sure that the frame sheet fabric is properly secured.
- Make sure that the back door zippers are fully closed.
- The wheel brakes must be locked before placing pets into stroller.



### 3 Back door ramp manual

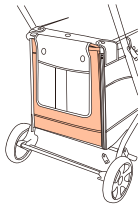

Lock rear wheel brakes.



Separate the snaps located on the back pocket. Lower both zippers entirely. Lower all zippers located on the back side.

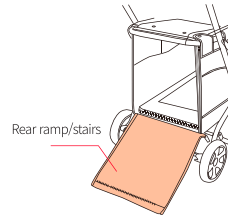

Rear ramp/stairs

When the rear door is pulled open the pet/pets can enter and exit on their own.

**Caution** : when using the ramp/stairs please make sure the ramp is touching the floor. Please make sure the ground is flat. Stroller rear wheel brakes must be locked before use.

### 4 Folding the cabin for compact folding

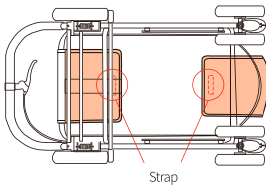

Open up the Velcro strap on the bottom of the cabin.

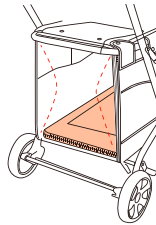

Open the zipper on the back door and place the inner mat in the cabin.

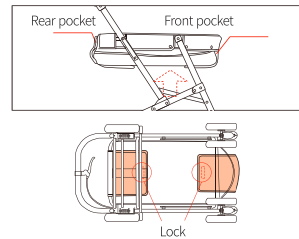

Firmly place the front and back pockets onto the Velcro placements below the cabin. Make sure that it is flat.

### 5 Folding the frame



Pull the two folding levers simultaneously while pushing the handle as if lifting.

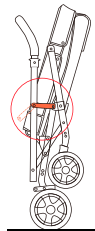
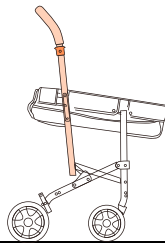

Place the hook

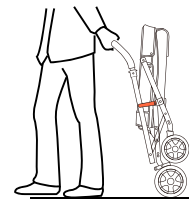

Unlock the rear brake to easily maneuver in folded state.

### 6 Pad usage

The sheet that is included is made to be used along with store branded pads (universal). Use the zipper to access the mesh panels to line the pad.

## BUDDY DUGGY RIDER COLLY PET STROLLER WAGON ASSEMBLY AND USAGE

### 7 Front wheel usage

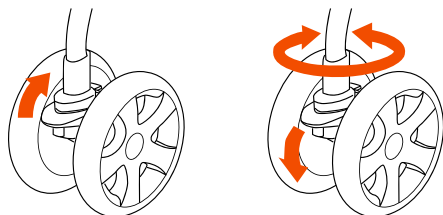

- When the front wheel brake is locked in the upper position the wheels will be locked in a straight position. In order to move freely from right to left, release the front brakes.
- While going on an incline or unstable roads, lock both wheels in the upper position to go straight.

### 8 Rear wheel lock usage

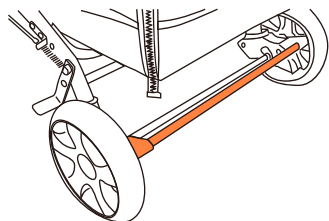

- The rear brakes are locked when pushed into the lower locked position. When the brake position is pushed up the stroller moves freely.
- Always lock the brakes while not in motion. Please look after pets while in stroller. Never leave your pets unattended.

### 9 Inspecting while in use

- The hand brake comes fully functional and checked before shipping out. However, with less frequent usage and over time the brake may loosen. Before using, please check the spacing between the rear wheels and brake pads. We recommend to visit your local bicycle store for maintenance and check.
- The tire and brake wires are irrelevant and do not affect the function of the brake. Before use, always check the brake to see that it is properly working. If there is a malfunction. Stop use immediately and reach out to us.

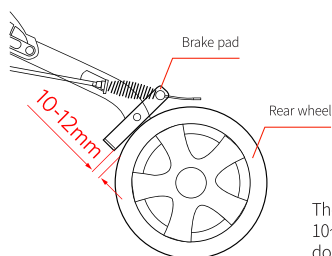

The distance between the brake pad and the tire should be at 10-12mm. If the distance is greater than 13mm, adjust accordingly. If in doubt, please visit nearest local bicycle store check.

## 10 3 way brake usage

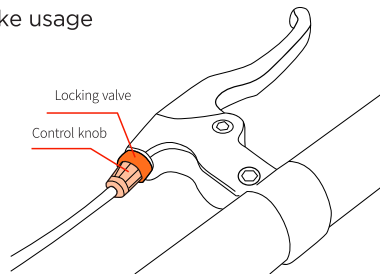

Release the locking valve on the handle to choose the desired distance and secure the valve again when finished.

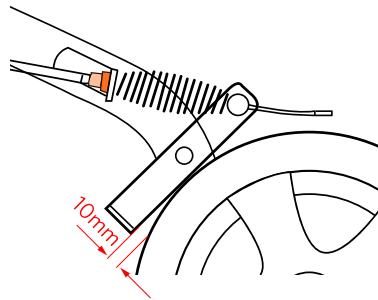

Release the locking valve located on the rear wheel brake pad. Once the control knob is at its desired position, resecure the locking valve.

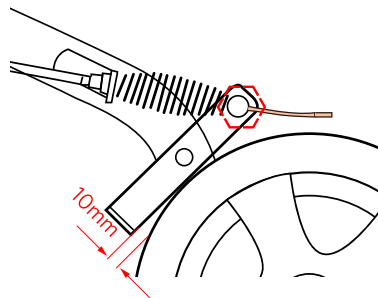

If the locking valve and control knob do not adjust, readjust the brake wires and try again.

**Caution**

- if the process is too difficult, we recommend to bring the stroller wagon to a bicycle shop to get the hand brake serviced.
- If the wheels need to be replaced, contact the seller or us to purchase authentic replacement wheels.

# **BUDDY DUGGY** BUDDY DUGGY RIDER COLLY PET STROLLER WAGON MANUAL

---

- The stroller may appear differently than pictured. However this is irrelevant to the performance of the product.

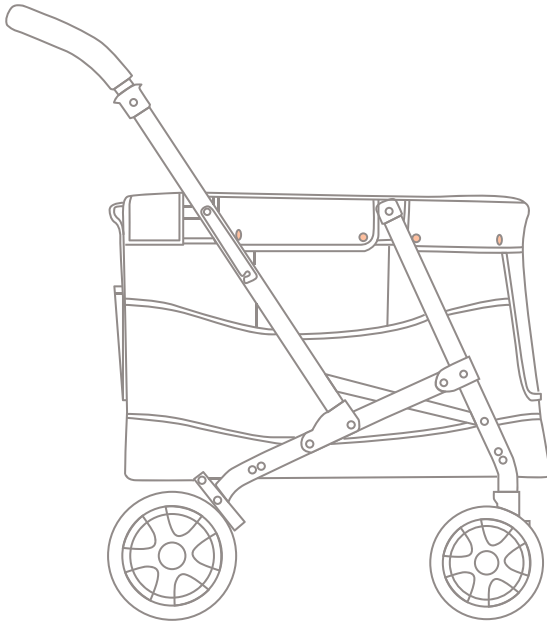

- Recommended weight of use: 30kg/66 lbs
- Product size:  
Overall product size: 22.8\*35\*38 in ; 58\*89\*97 cm  
Cabin size: 15.7\*26.8\*16.5 in ; 40\*68\*42 cm
- Materials: steel, polyester, plastic
- Product weight: 11kg/24lbs
- Made in China. Designed in S. Korea.

- 
- Caution**
- this product was made for pets and pets only. DO NOT use for other purposes.
  - Please read through manual thoroughly to prevent any misuse and injury.

To prevent misuse and injury please carefully read through directions and precautions.

## WARRANTY

Buddy Duggy is dedicated to provide high quality design, engineering, production, and product performance. Buddy Duggy offers a one year warranty on all pet strollers. In case of any defect, please check [www.bdbuddyduggy.com](http://www.bdbuddyduggy.com) for more detailed information regarding warranty, general information, customer services, and after services. If you have any questions or concerns about this product or this user manual please contact us before using the product. We are looking forward to hearing from you.

### · KEEP THESE INSTRUCTIONS FOR FUTURE REFERENCE

Warning : Never leave your pet unattended. It may be dangerous. This product is not suitable for running or skating. To avoid injury ensure that your pet or anyone kept away when unfolding and folding this product. Please follow the instructions and precautions carefully to use the product safely and correctly. Failure to follow these instructions and precautions when using the Product runs the risk of causing serious injury or damage to you, the user, pets, others, and property around you.

1. Always make sure the pet harness is attached to the stroller when using the stroller. Please keep your pet from jumping out and falling off the stroller.
2. Do not leave your pet unsupervised in the stroller. Do not leave your pet in the pet stroller for extended periods of time.
3. Do not leave the stroller on a slope when the pet is seated in it, even if the brake is engaged. Brake efficiency is limited on high gradients. Be careful of steep slopes.
4. Be careful not to get your fingers caught when folding the stroller.
5. Make sure to remove your pet in a safe location before folding the stroller.
6. Do not carry items, children, or people on the stroller. For pets only.
7. To prevent the stroller from becoming unstable, do not place parcels or accessory items anywhere except in the storage basket and pockets provided. DO not hang items such as shopping bags from the frame.
8. Do not park the stroller on ramps.
9. Zipper up(lock) the canopy for safety when strolling.
10. Before assembling, verify that the products and all its components have not been subject to damages during transport. Should this be the case, do not use the product and keep it out of reach of pets and children. Be sure to check that there is no corrosion or damage to the product before use.
11. On unpaved roads, snowy or wet roads, the brake efficiency may decrease. Be careful as the wheels may slip and cause accidents.
12. Any goods carried in the basket not to exceed 3kgs (6lbs)
13. Only use Buddyduggy replacement parts.

This stroller is for pets (dogs and cats) weighing less than 30KG(66lbs). Do not use the stroller for any other purpose.

Due to differences in pets behaviors and individual differences, weight limits may vary.

- Please check the following 3 steps when placing and removing your pet from the stroller bassinet.
  1. Ensure that all locking devices are engaged before placing and removing your pet from the stroller.
  2. Be careful when folding, as pets may get caught.
  3. Make sure the bassinet is properly installed on the frame.

- Other precautions, care, and maintenance.

1. Injuries and accidents caused by the unexpected behavior of pets, please be careful.
2. If the product is used or stored excessively, it may be damaged or the parts may wear out quickly.
3. Our warranty does not cover accidents caused by improper repair, modification or misuse.
4. Do not leave the stroller and bassinet in direct sunlight for long periods of time as this may cause color change in some materials. Please keep it in a well-ventilated place.
5. Please do not leave the product out in the rain or damp places.
6. The stroller should not be used near an open fire or exposed flame.
7. If stored in an unclean state, it may cause fleas and mites to breed, so please keep it maintained and clean.
8. In order to keep the stroller in good condition, it is necessary to use the product cleanly and pay attention to its maintenance.
9. Inspect the stroller and accessories regularly for signs of damage and wear.
10. Check the shape of the metal parts for deformation or cracks and stop using if there are any problems.
11. For plastic and metal parts, wipe the contaminated area with a dry towel.
12. Do not use cleaning agents such as abrasives, solvents, ammonia or bleach.
13. Gently wipe the hood and seat with a clean cloth and dry them completely.
14. Do not machine wash, iron, bleach, and dryer. Gently wipe the plastic and petal parts with a wet cloth. Dry thoroughly after cleaning.
15. Brakes and wheels are subject to wear and should be replaced if necessary.
16. Do not apply excessive force to the wheel or frame, and if in doubt, check the instructions.
17. Use only genuine parts supplied or recommended by buddyduggy.
18. Moving parts may be lubricated with WD-40 spray or other silicone coating products. Do not use products containing oil or grease.
19. Regular inspection prolongs the life of your stroller.

This warranty does not cover:

- Defects caused by misuse or poor maintenance; please refer to the product manual for guidance on item use and maintenance
- Damage caused by improper installation of BUDDY DUGGY parts and/or accessories; please refer to product instruction booklet for guidance on item assembly and use
- Damage caused by corrosion mold or rust
- Damage resulting from normal wear and tear
- Damage or degradation caused by the sun, sweat, detergents, damp storage conditions or frequent washings
- Repairs or modifications carried out by a third party
- Product purchased from an unauthorized retailer; authorized retailers are listed here
- Second owners and users other than the registrant
- Damage resulting from airline shipping and handling
- Products Involved in an accident
- BUDDY DUGGY reserves the right to determine if warranty terms and conditions have been met.

#### CARE INSTRUCTION

- Do not machine wash.
- Do not use bleach or aggressive detergents
- Do not tumble dry
- Do not iron
- Do not dry clean
- Always use cold water and mild soap to give the entire fabric area and canopy a good cleaning with a damp cloth. For the chassis: clean
- With a dry towel, wipe away excess water and soap.
- Let the fabric air dry in a warm place, but not in direct sunlight.
- Routinely inspect and maintain your stroller.
- For the chassis: clean with a soft towel and lukewarm water. Make sure to wipe off any remaining water with a dry cloth. Use a soft brush to clean any dirt and sand from the mechanisms and plastic parts of the chassis.
- Wheels : Use a soft towel, brush, and water to clean dirt on the wheels. Periodically, remove the wheels from the chassis and brush off any dirt or sand in the wheel parts.
- After washing all parts make sure to always reassemble and check if all is working properly as instructed in the user guide.
- Wet conditions : Store your Bugaboo stroller and its accessories in a dry place and leave them to dry unfolded to prevent mold.

**S2FAM COMPANY, LLC**  
Jericho, New York 11753  
[www.bdbuddyduggy.com](http://www.bdbuddyduggy.com) / [support@s2fam.com](mailto:support@s2fam.com)

**BUDDY DUGGY**