

bernette

SWISS DESIGN



**COVERSTITCH  
CHAINSTITCH  
COMBO STITCH**

**WORKBOOK #2  
COVERSTITCH, CHAINSTITCH, COMBO STITCH**

For bernette Overlockers: b42, b48, b62, b68

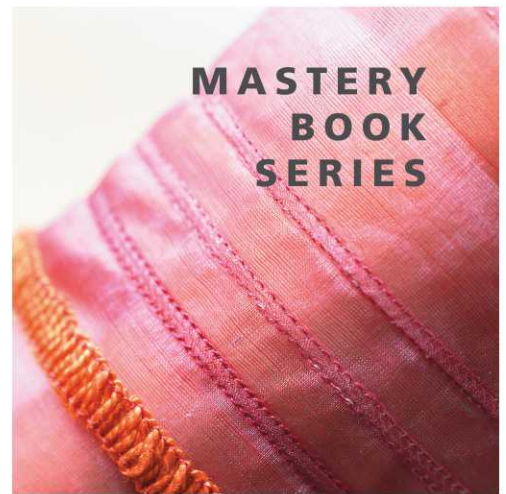

**MASTERY  
BOOK  
SERIES**



# TABLE OF CONTENTS

INTRODUCTION .....3

REFERENCE-OVERLOCKER NEEDLES .....4

REFERENCE-OVERLOCKER THREADS .....5

COMBO STITCH: 3-THREAD OVERLOCK (NARROW) + CHAINSTITCH (b48 and b68).....6

MACHINE CONVERSION (b48) .....7

MACHINE CONVERSION (b68) .....8

BEGIN/END COVER-/CHAINSTITCH.....9

4-THREAD COVERSTITCH ..... 10

3-THREAD COVERSTITCH WIDE ..... 11

3-THREAD COVERSTITCH NARROW ..... 12

2-THREAD CHAINSTITCH ..... 13

SUPPLIES..... 14



The information in this workbook applies to the bernette Overlocker Machines models shown above.

**Note:** Some exercises apply only to certain models equipped with the feature being highlighted.

# INTRODUCTION

Congratulations on the purchase of your new bernette overlocker. Learning to use your new machine to its fullest capabilities will let you enjoy your machine for many years. Understanding your machine's features and learning its navigation will maximize your creativity.

The b48 and b68 are Combo Machines, which means that in addition to the standard offering of Overlock stitches the machine can also do Coverstitches, a Chainstitch, and Combo Stitches. In order to do this, the machine must go through a process of setting up the stitching with a series of simple changes; locking the upper looper, changing the insert, deactivating the cutting knife and moving the needles. The b42 and b62 are Cover-/Chainstitch machines that do not have overlock capability.

**Coverstitch**—a hem finish technique commonly found on the bottom of t-shirts and other knitwear. The coverstitch can use up to three needles resulting in four variations of this stitch. It is great for its stretch and strength, but can be used in many decorative ways.

**Chainstitch**—similar to a straight stitch on a sewing machine, this stitch is made with one needle and one looper. It is quick to remove and makes a fast way of basting, but can be an alternative stitch for seaming and decorative applications as well.

**Combo Stitch**—this style of stitch can only be created on a combo machine, as it is a chainstitch combined with a 3- or 2-thread overlock edge finish. This is a time-saving stitch because it performs the action of two different stitches in one action. Combo stitches are great for long straight seams and are often used for seaming ready-to-wear jeans.

For more information on the bernette line of sewing machines and overlockers, as well as sewing projects, visit:

[www.mybernette.com](http://www.mybernette.com)



Click the YouTube icon to watch additional YouTube tutorial videos about the bernette line of overlockers.

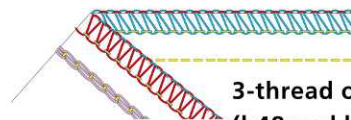

**3-thread overlock with chainstitch  
(b48 and b68 only)**

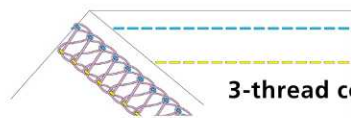

**3-thread coverstitch-wide**

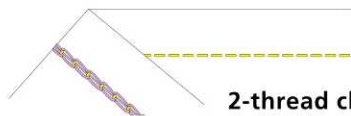

**2-thread chainstitch**

# REFERENCE–OVERLOCKER NEEDLES

## bernette Overlocker Needles

Along with thread, needles are very important to stitch formation. Many mechanical problems and damage to fabrics can be traced to a bent, damaged, or incorrect size or type needle.

When selecting the correct needle, consider the following:

- Recommended needle system – ELx705. These needle are a flat shank industrial needle. A pack of these needles is included with the overlocker.
- Recommended sizes for the b60 Series Overlockers are 80/12 to 100/16. Recommended sizes for the b40 Series Overlockers are 70/10 to 90/14. Too large of a needle can interfere with looper movement and cause damage; too small of a needle may not form the stitches correctly.
- Needle point – assures proper stitch formation; avoids fabric damage

## Need to Know

- Always make sure needles are fully inserted as high as possible, with the flat side to the back. The left needle will appear to be slightly higher than the right needle.
- Do not pull or push fabric while sewing. This can result in needle breakage or damage.
- Do not use bent or damaged needles.
- The needle is the most inexpensive part in your sewing machine, but it is crucial for getting good results and keeping your machine running well.
- The selected thread should fit in the groove on the front of the needle. If it isn't protected by the groove, a needle with a larger groove should be used.

Tip: If one needle breaks, it is a good habit to change both needles. Keeping the needle size and type the same results in a better formed stitch.

### Needle Size for Fabrics

70 – shirt-weight  
 80 – medium-weight  
 90 – denim and twill  
 100–very heavy fabrics  
 (b60 series only)

### Parts of a Needle

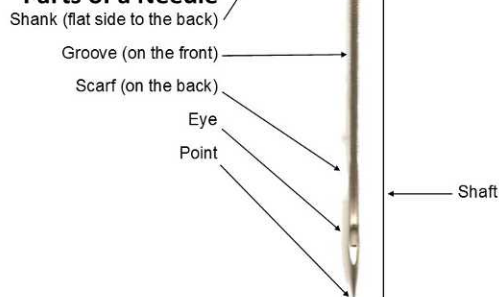

# REFERENCE—OVERLOCKER THREADS

---

## Overlocker Threads

Overlocker threads are usually polyester and are finer (lighter weight) than many sewing machine threads to avoid thread build-up and excessive bulk in seams. It is important that the thread is smooth and without variations in diameter as it needs to feed smoothly through many thread guides for good stitch formation.





You also want a good-quality thread—such as Mettler Seracor—that is not “fuzzy” and does not leave excessive lint in the lower part of your overlocker. Overlocker threads are sold on larger spools for economy and convenience; regular spools of thread may be used but will not last very long when forming overlock stitches. Along with overlocker thread, there are applications that call for specialty and decorative threads.

Listed below are some of these threads commonly used in the overlocker:

- Texturized Nylon Thread—such as YLI Woolly Nylon or Maxi-Lock Stretch or Wonderfil SoftLoc—a very elastic thread with excellent coverage; perfect for rolled edges and knit seams.
- Topstitching Thread—such as Jeans Stitch, Mettler Cordonnet, Aurifil 12wt Cotton and Wonderfil Spagetti—this heavy thread is used for decorative stitching (flatlocked seams and overcast edges). Also nice for cover and chain stitching. Topstitch thread can be polyester or cotton.
- Rayon Decorative Threads—such as Pearl Crown Rayon, Madeira Rayon 40 & YLI Designer 6 – shiny threads for decorative applications. Pearl Crown Rayon is twisted, while Designer 6 is untwisted. Available in solid and variegated colors.
- Metallic Decorative Threads—add a bit of glitz to seams and edgings.
- Decorative Sewing Threads—sewing machine threads can also be used in the overlocker, and are particularly effective when several are used together as one thread.
- **TIP:** Avoid using threads with heavy wax coatings in the air threading system. Coated or waxed threads may lose some of their coating in the air threader pipes, resulting in permanent blocking of the pipes. Repair by a BERNINA dealer will be necessary.



# COMBO STITCH: 3-THREAD OVERLOCK (NARROW) + CHAINSTITCH (b48 and b68)

-  Medium weight denim, 6" x 8"
-  80/12 ELx705
-  5 Spools Serger Thread (B, R, G, Y, P)
-  3-thread Overlock (RN) + Chainstitch (CC)
-  Standard Foot

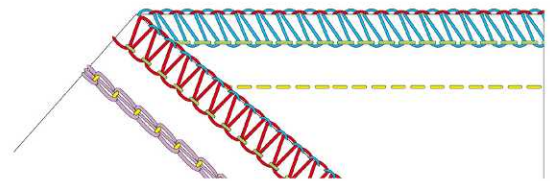

### b48 and b68 ONLY:

This stitch is a combination of a 3-thread Overlock plus a Chainstitch. This sample will have a narrow overlock edge finish. Use the left needle for a wider overlock. On the b68 a wider seam allowance can be achieved using the Left Coverstitch Needle.

1. Thread the overlocker for a 3-thread Overlock (narrow) plus Chainstitch using the thread colors to match the Color-coded Threading Path on the machine and diagram in the user manual. Adjust all thread settings as indicated in the chart below. The mechanics of the machine will be set as if to do a regular overlock. Use the Right Overlock Needle position and the Center Coverstitch Needle position.
2. Fold the fabric in half to 3" x 8".
3. To begin stitching, trim the edge of the fabric fold at ¼" approximately 1" long. Then lift the Presser Foot and slide the fabric under the Presser Foot and underneath the needles. Release the Presser Foot and begin stitching, trimming the fold away. NOTE: Trimming a minimum ¼" will result in a cleaner edge finish.
4. Stitch to the end of the fabric. Continue stitching off the fabric until you have a 3-4" thread chain. Cut thread chain with scissors (b48) or use the Thread Cutter on the b68.

									MACHINE SETUP				
	LEFT COVERSTITCH NEEDLE	CENTER COVERSTITCH NEEDLE	RIGHT COVERSTITCH NEEDLE	LEFT NEEDLE	RIGHT NEEDLE	UPPER LOOPER (B)	LOWER LOOPER (R)	CHAINSTITCH LOOPER (P)	STITCH LENGTH	CUTTING WIDTH	DIFFERENTIAL FEED	ROLLED HEM LEVER	PRESSER FOOT PRESSURE
b48	-	2	-	-	4.5	4.5	4	5.5	2.5	6	1	N	N
b68	-	3.5	-	-	4.5	4	4	4	3	6	1	N	N
My SETTINGS													

# MACHINE CONVERSION (b48)

-  80/12 ELx705
-  4 Spools Serger Thread (B, G, Y, P)
-  Standard Foot

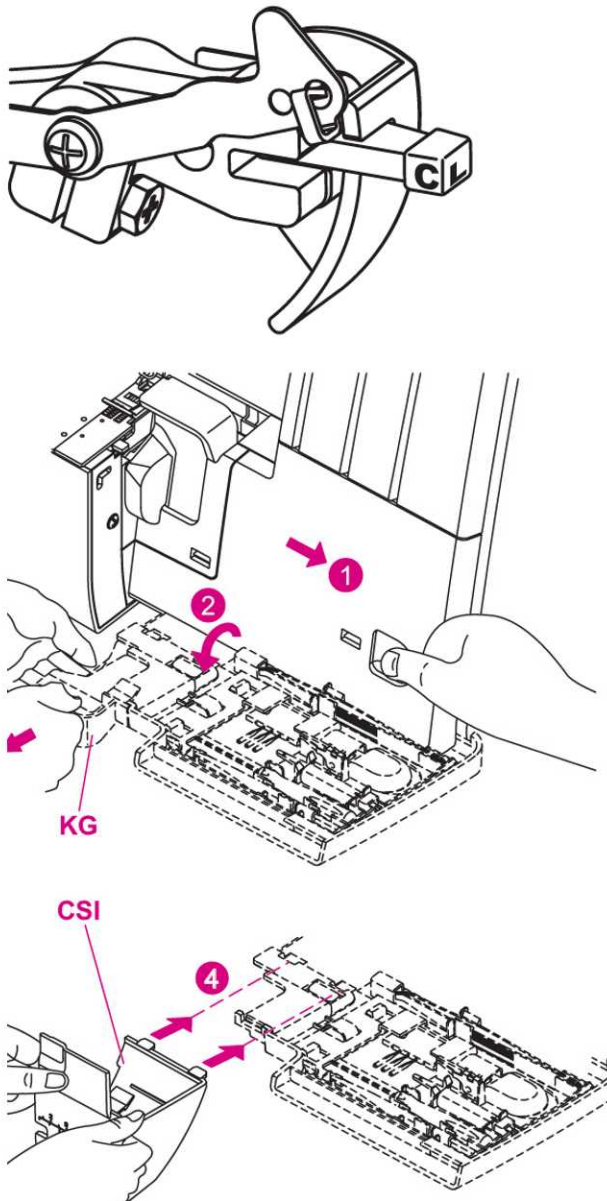

Converting the b48 from overlock to coverstitch and back requires some mechanical machine set-up steps. When doing this, make sure to turn the power to the machine off.

1. Open the Loper Cover.
2. Move the Knife into a non-working position. Pull the Knife Holder to the right and rotate the holder counter clockwise until the Knife clicks into a locked position.
3. Disengage the Upper Loper by turning the handwheel until the drive shaft is in the correct position to lock the clutch button for cover/chainstitch showing the letter "C".
4. Set the rolled hem selection lever to the "R" position.
5. Remove the knife cover and install the seam guide plate in the Loper Door.
6. Remove the needles from the Overlock position(s).
7. Install the needles into the Coverstitch position(s).
8. Thread the machine for Coverstitch as shown in the diagram and machine manual.
9. Close the Loper Cover.

# MACHINE CONVERSION (b68)

-  80/12 ELx705
-  4 Spools Serger Thread (B, G, Y, P)
-  Standard Foot

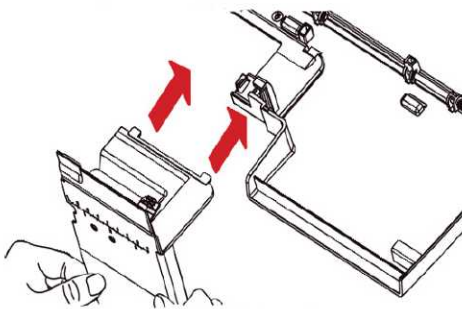
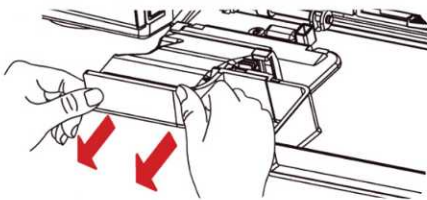

Converting the b68 from overlock to coverstitch and back requires some mechanical machine set-up steps. When doing this, make sure to turn the power to the machine off.

1. Open the Looper Cover.
2. Move the Knife into a non-working position. Pull the Knife away from the Stitch Plate as far as possible and then lower it forwards to the lock-in position.
3. Check that the Upper Looper Converter is hooked out and the Upper Looper is in the lowest position. Deactivate the Upper Looper by moving the Upper Looper On/Off switch to the left.
4. Set the Rolled Hem Selection Lever to the "R" position.
5. Remove the Knife Cover and install either the Coverstitch Insert or the Coverstitch Insert for Slide-on Table.
6. Remove the needles from the Overlock position(s).
7. Install the needles into the Coverstitch position(s).
8. Thread the machine for Coverstitch as shown in the machine manual.
9. Close the Looper Cover.



# BEGIN/END COVER-/CHAINSTITCH

 80/12 ELx705

 4 Spools Serger Thread (B, G, Y, P)

 Standard Foot

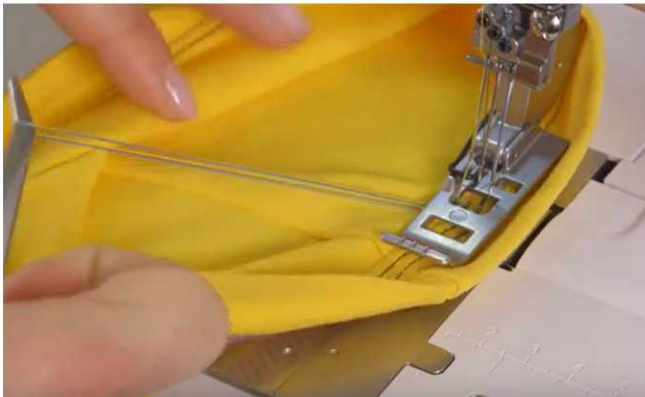

At START of sewing:

1. Raise the Presser Foot.
2. Place fabric under the Presser Foot behind the needles and lower the Presser Foot.
3. Begin sewing with fabric under the foot. When you start sewing in the middle of the fabric, place the fabric under the needles at the desired point of sewing.

At END of sewing:

1. Stop sewing at the edge of the fabric (or if sewing in a tubular shape, sew over a few stitches at the beginning and stop).
2. Raise the needles to the highest position.
3. Raise the Presser Foot.
4. Using tweezers (b42, b48) or the CS Lock Tool (b62, b68), move from behind the needle threads (over the fabric) and pull the threads from under the foot out to the left of the machine. Trim the thread.
5. Remove the fabric from under the foot toward the back and left of the machine. The thread tails will release and move to the back of the fabric locking the stitch in place.
6. Trim the looper thread and keep the remaining thread tail to the back of the machine to prepare for the next stitching.

Tip: Avoid chaining off when sewing a coverstitch because the machine cannot maintain the stitch without fabric and it may cause problems with thread breaking or the machine coming unthreaded.



Remove the slide-on table on the b62 or b68 and use the Freearm when hemming tubular items.

# 4-THREAD COVERSTITCH



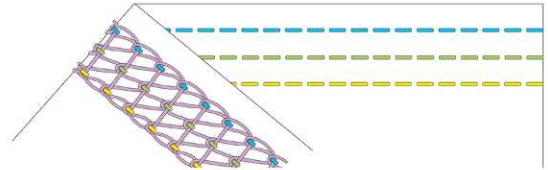

-  Sweatshirt knit, 4" x 8"
-  80/12 ELx705
-  4 Spools Serger Thread (B, G, Y, P)
-  4-thread Coverstitch (LC-CC-RC)
-  Standard Foot



1. Set the overlocker for a 4-thread Coverstitch. Adjust settings as directed below.
2. Fold the fabric under 1" with wrong sides together to create a hem and align the fabric under the Presser Foot, using the guidelines on the Stitch Plate. Place the fabric completely under the foot.
3. Stitch to the end of the fabric.
4. At the end of the stitching, carefully end and lock your stitch as described on Page 8.
5. Adjust settings as necessary; stitch a second row of coverstitch.

THREAD TENSION SETTING					MACHINE SETUP		
OVERLOCKER	LEFT COVERSTITCH NEEDLE	CENTER COVERSTITCH NEEDLE	RIGHT COVERSTITCH NEEDLE	CHAINSTITCH LOOPER	STITCH LENGTH	DIFFERENTIAL FEED	PRESSER FOOT PRESSURE
b42	4	4	4	4	3	1	NORMAL
b48	3	6	6.5	4	3	1	NORMAL
b62	4	4	4	4	3	1	NORMAL
b68	3	6	6	4	3	1	NORMAL
My Settings							

# 3-THREAD COVERSTITCH WIDE

-  **Medium weight cotton, 4" x 8"**
-  **80/12 ELx705**
-  **3 Spools Serger Thread (B, Y, P)**
-  **3-thread Coverstitch Wide (LC-RC)**
-  **Standard Foot**

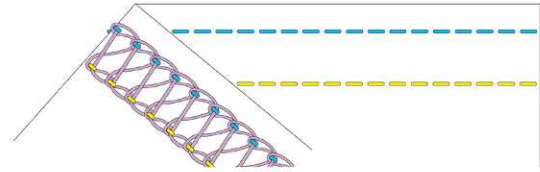

1. Set the overlocker for a 3-thread Coverstitch Wide using the Left Coverstitch Needle and the Right Coverstitch Needle (remove the Center Coverstitch Needle and thread). Adjust settings as directed below.
2. Fold up a 2" hem along the 8" edge of the fabric. Glue stick or pin in place.
3. Using the markings on the Stitch Plate as a guide, place the fabric under the needles with the fold to the right of the Presser Foot, and with the right side of the fabric up and the hem/wrong side down.
4. Coverstitch the hem in place.

THREAD TENSION SETTING					MACHINE SETUP		
OVERLOCKER	LEFT COVERSTITCH NEEDLE	CENTER COVERSTITCH NEEDLE	RIGHT COVERSTITCH NEEDLE	CHAINSTITCH LOOPER	STITCH LENGTH	DIFFERENTIAL FEED	PRESSER FOOT PRESSURE
b42	4	-	4	4	3	1	NORMAL
b48	3	-	6.5	4	3	1	NORMAL
b62	4	-	4	4	3	1	NORMAL
b68	2.5	-	4.5	4	3	1	NORMAL
My Settings							

# 3-THREAD COVERSTITCH NARROW

-  Jersey knit, 6" x 8"
-  80/12 ELx705
-  3 Cones Serger Thread (G, Y, P)
-  3-thread Coverstitch Narrow (LC-CC)
-  Standard Foot

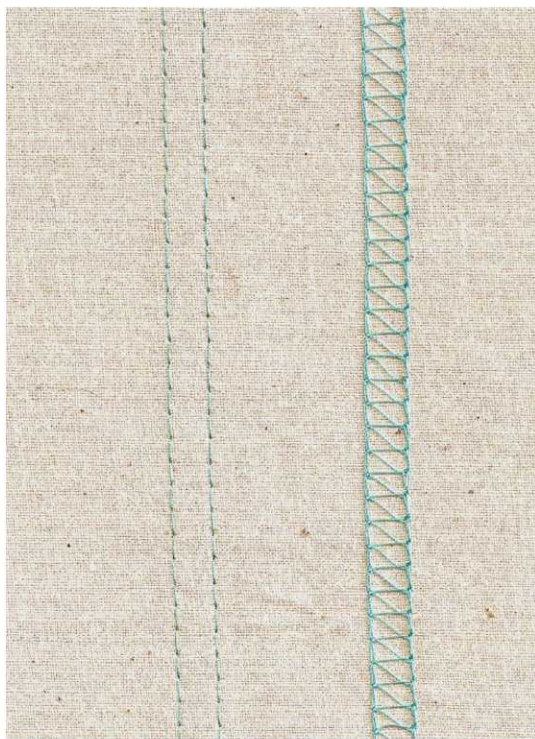
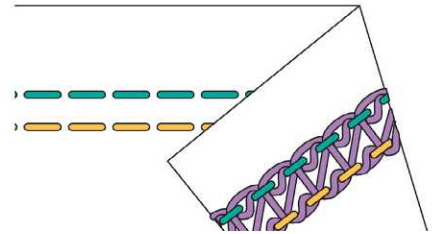

1. Set the overlocker for a 2-thread Coverstitch Narrow using the Left Coverstitch Needle and the Center Coverstitch Needle. (Remove the Right Coverstitch Needle and thread, then insert the Center Coverstitch Needle and thread the needle.) Adjust settings as directed below.
2. Fold the fabric under 1" to create a hem and align the fabric under the Presser Foot. Use the guidelines on the Stitch Plate. Place the fabric completely under the foot.
3. Stitch to the end of the fabric.
4. At the end of the stitching carefully end and lock your stitch as described on Page 8.

THREAD TENSION SETTING					MACHINE SETUP		
OVERLOCKER	LEFT COVERSTITCH NEEDLE	CENTER COVERSTITCH NEEDLE	RIGHT COVERSTITCH NEEDLE	CHAINSTITCH LOOPER	STITCH LENGTH	DIFFERENTIAL FEED	PRESSER FOOT PRESSURE
b42	4	4	-	4	3	1	NORMAL
b48	3	6	-	4	3	1	NORMAL
b62	4	4	-	4	3	1	NORMAL
b68	3.5	6	-	4	3	1	NORMAL
My Settings							

# 2-THREAD CHAINSTITCH

-  Denim, 6" x 8"
-  80/12 ELx705
-  2 Cones Serger Thread (G, P)
-  2-thread Chainstitch (CC)
-  Standard Foot

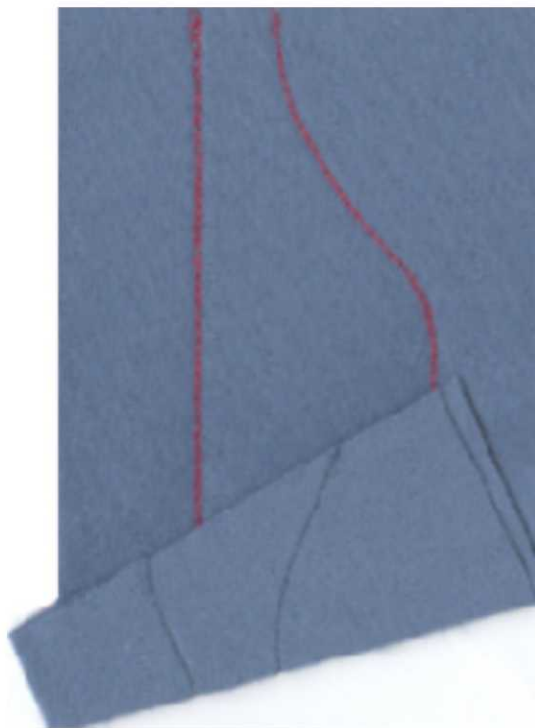
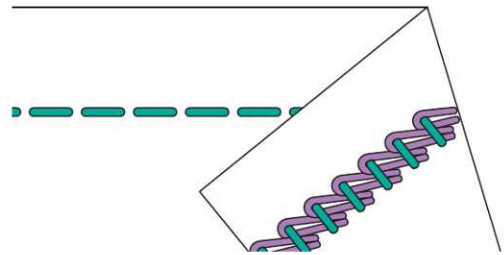

1. Set up the machine for a chainstitch using the Center Coverstitch Needle. (The Right Coverstitch Needle/thread and the Left Coverstitch Needle/thread should be removed.) Adjust settings as directed below.
2. Place the fabric under the foot and stitch using straight lines and gentle curves.
3. Stitch to the end of the fabric.
4. At the end of the stitching, carefully end and lock your stitch as described on Page 8.

THREAD TENSION SETTING					MACHINE SETUP		
OVERLOCKER	LEFT COVERSTITCH NEEDLE	CENTER COVERSTITCH NEEDLE	RIGHT COVERSTITCH NEEDLE	CHAINSTITCH LOOPER	STITCH LENGTH	DIFFERENTIAL FEED	PRESSER FOOT PRESSURE
b42	-	2.5	-	5.5	3	1	NORMAL
b48	-	4.5	-	5.5	3	1	NORMAL
b62	-	3	-	3	3	1	NORMAL
b68	-	6	-	4	3	1	NORMAL
My Settings							

# SUPPLIES

---

NEEDLES AND THREADS
80/12 ELX705 Serger Needles (2 come with machine)
b48, b68: 5 Spools Serger Thread (blue, red, purple, green, yellow)
b42, b62: 4 Spools Serger Thread (purple, blue, green, yellow)

FABRICS FOR EXERCISES		
QUANTITY	SIZE	FABRIC
2 for b48, b68 1 for b42, b62	6" x 8"	Medium weight denim
1	4" x 8"	Sweatshirt knit
1	4" x 8"	Medium weight cotton
1	6" x 8"	Jersey knit