

bernette

SWISS DESIGN



WORKBOOK #1 – BASIC SERGER USE

For Bernette Overlockers: b44, b48, b64, b68

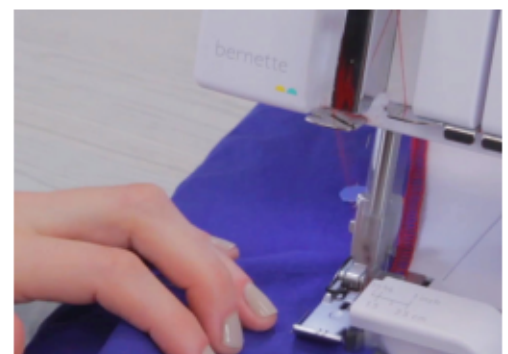

TABLE OF CONTENTS

INTRODUCTION	3
REFERENCE—OVERLOCKER NEEDLES	4
REFERENCE—OVERLOCKER THREADS	5
4-THREAD OVERLOCK STITCH	6
ADJUSTING TENSION SETTINGS FOR BALANCED STITCH	7
STITCH LENGTH	8
CUTTING WIDTH.....	9
DIFFERENTIAL FEED: STRETCHY FABRICS.....	10
DIFFERENTIAL FEED: SOFT FABRICS.....	11
PRESSER FOOT PRESSURE.....	12
3-THREAD OVERLOCK STITCH-WIDE.....	13
3-THREAD FLATLOCK - WIDE.....	14
3-THREAD OVERLOCK STITCH-NARROW	15
3-THREAD FLATLOCK - NARROW	16
3-THREAD ROLLED HEM	17
2-THREAD ROLLED HEM	18
2-THREAD FLATLOCK - NARROW	19
OVERLOCKER TECHNIQUES: SECURING SEAMS.....	20
OVERLOCKER TECHNIQUES: INSIDE CORNER	21
OVERLOCKER TECHNIQUES: OUTSIDE CORNER	22
OVERLOCKER TECHNIQUES: DIFFERENTIAL FEED AND GATHERING	23
SUPPLIES.....	24



The information in this workbook applies to the bernette Overlocker Machine models shown above.

Note: Some exercises apply only to certain models equipped with the feature being highlighted.

INTRODUCTION

Congratulations on the purchase of your new bernette overlocker. Learning to use your new machine to its fullest capabilities will let you enjoy your machine for many years. Understanding your machine's features and learning its navigation will maximize your creativity. While you will be learning some basics, you'll also be learning some creative techniques, and we hope both will be inspirational.

Your overlocker will speed your sewing in many ways, letting you produce more in less time. The speed of the overlocker is faster than a sewing machine, and because it performs several operations (trimming, seaming, and overcasting) at the same time, your project is finished faster and will produce neater and more professional results.

Even though the workings of the overlocker may appear be more complex than a sewing machine, it doesn't take long to learn the basics. The stitching exercises in this workbook use four, three, and two thread stitch formations.

Once you have completed the exercises designated for your bernette overlock machine, attach the sewn samples to the indicated pages, insert the pages into plastic page protectors and store them in a 3-ring binder. Use this workbook as a reference tool in the future as you learn to use your overlocker in new ways.

For more information on the bernette line of sewing machines and overlockers, as well as sewing projects, visit:

www.mybernette.com



Click here to watch additional YouTube tutorial videos about the bernette line of overlockers.

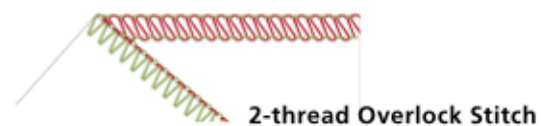
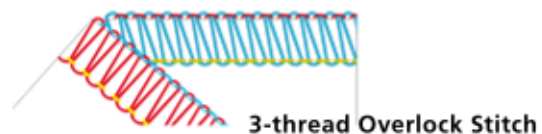
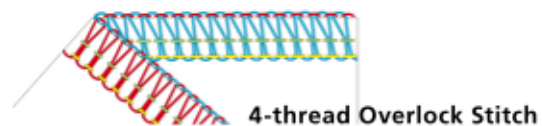

REFERENCE—OVERLOCKER NEEDLES

bernette Overlocker Needles

Along with thread, needles are very important to stitch formation. Many mechanical problems and damage to fabrics can be traced to a bent, damaged, or incorrect size or type needle.

When selecting the correct needle, consider the following:

- Recommended needle system—ELx705. These needle are a flat shank industrial needle. A pack of these needles is included with the overlocker.
- Recommended sizes for the b60 Series Overlockers are 80/12 to 100/16. Recommended sizes for the b40 Series Overlockers are 70/10 to 90/14. Too large of a needle can interfere with looper movement and cause damage; too small of a needle may not form the stitches correctly.
- Needle point—assures proper stitch formation; avoids fabric damage

Need to Know

- Always make sure needles are fully inserted as high as possible, with the flat side to the back. The Left Needle will appear to be slightly higher than the Right Needle.
- Do not pull or push fabric while sewing. This can result in needle breakage or damage.
- Do not use bent or damaged needles.
- The needle is the most inexpensive part in your sewing machine, but it is crucial for getting good results and keeping your machine running well.
- The selected thread should fit in the groove on the front of the needle. If it isn't protected by the groove, a needle with a larger groove should be used.

Tip: If one needle breaks, it is a good habit to change both needles. Keeping the needle size and type the same results in a better formed stitch.

Needle Size for Fabrics

70—shirt-weight
80—medium-weight
90—denim and twill
100—very heavy fabrics
(b60 Series only)

Parts of a Needle

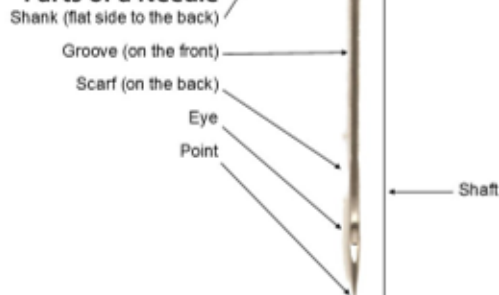

REFERENCE—OVERLOCKER THREADS

Overlocker Threads

Overlocker threads are usually polyester and are finer (lighter weight) than many sewing machine threads to avoid thread build-up and excessive bulk in seams. It is important that the thread is smooth and without variations in diameter as it needs to feed smoothly through many thread guides for good stitch formation.





You also want a good-quality thread—such as Mettler Seracor—that is not “fuzzy” and does not leave excessive lint in the lower part of your overlocker. Overlocker threads are sold on larger spools for economy and convenience; regular spools of thread may be used but will not last very long when forming overlock stitches. Along with overlocker thread, there are applications that call for specialty and decorative threads.

Listed below are some of these threads commonly used in the overlocker:

- Texturized Nylon Thread—such as YLI Woolly Nylon or Maxi-Lock Stretch or Wonderfil SoftLoc—a very elastic thread with excellent coverage; perfect for rolled edges and knit seams.
- Topstitching Thread—such as Jeans Stitch, Mettler Cordonnet, Aurifil 12wt Cotton and Wonderfil Spagetti—this heavy thread is used for decorative stitching (flatlocked seams and overcast edges). Also nice for cover and chain stitching. Topstitch thread can be polyester or cotton.
- Rayon Decorative Threads—such as Pearl Crown Rayon, Madeira Rayon 40 & YLI Designer 6 – shiny threads for decorative applications. Pearl Crown Rayon is twisted, while Designer 6 is untwisted. Available in solid and variegated colors.
- Metallic Decorative Threads—add a bit of glitz to seams and edgings.
- Decorative Sewing Threads—sewing machine threads can also be used in the overlocker and are particularly effective when several are used together as one thread.
- **TIP:** Avoid using threads with heavy wax coatings in the air threading system. Coated or waxed threads may lose some of their coating in the air threader pipes, resulting in permanent blocking of the pipes. Repair by a BERNINA dealer will be necessary.



4-THREAD OVERLOCK STITCH

-  Firm fabric, 6" x 6"
-  80/12 ELx705
-  4 Spools Serger Thread (B, R, G, Y)
-  4-thread Overlock
-  Standard

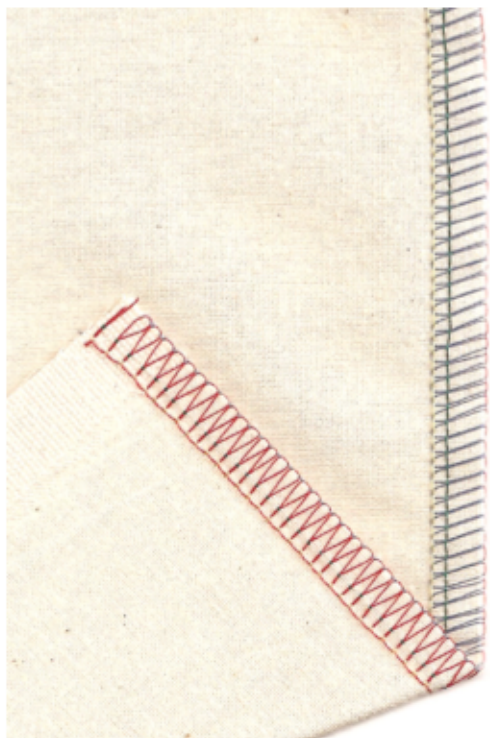
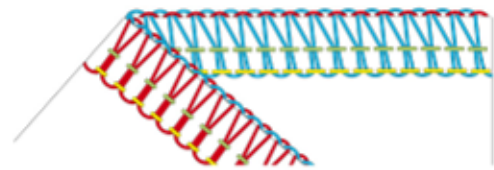

-  Left Needle
-  Right Needle
-  Upper Loper
-  Lower Loper

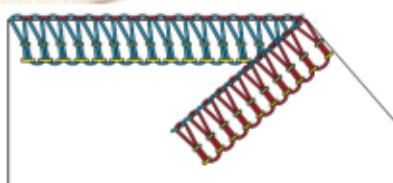

1. Thread the overlocker for a 4-thread Overlock using thread colors to match the Color-coded Threading Path on the machine. Adjust all thread tension settings as indicated in chart below.
2. Fold the fabric in half to 3" x 6".
3. For best results, raise the needles to their highest position before stitching. To begin stitching, lift the front of the Presser Foot with your thumb and slide the fabric under the foot. Release the tip of the Presser Foot and begin stitching, trimming the fold away. NOTE: Trimming a minimum of 1/4" will result in a cleaner edge finish.
4. Stitch to the end of the fabric. Continue stitching off the fabric until you have a 3"- 4" thread chain. Cut thread chain with scissors.
5. Examine the stitch formation:
 - Blue: Loops should extend to the edge of the fabric where they will interlock with the red loops of the Lower Loper.
 - Red: Loops should extend to the edge of the fabric, interlocking with the blue loops of the Upper Loper.
 - Yellow: Needle stitches should appear along the left edge of the stitch as straight stitches on the front and "dots" of thread on the back.
 - Needle stitches should appear as a line of straight stitching running through the middle of the overlock stitching on the front and as "dots" of thread on the back.
6. See following page for tension adjustment information. Make any necessary tension adjustments and sew another 4-thread Overlock Stitch. Record your setting adjustments on the fabric if necessary.

THREAD TENSION SETTING					MACHINE SETUP			
	LEFT NEEDLE	RIGHT NEEDLE	UPPER LOOPER	LOWER LOOPER	STITCH LENGTH	CUTTING WIDTH	DIFFERENTIAL FEED	ROLLED HEM LEVER
b44	4	4	4	4	2.5	6	1	N
b48	4	4	4	4	2.5	6	1	N
b64	4	4	4	4	2.5	6	1	N
b68	4	4	4	4	2.5	6	1	N
My Settings								



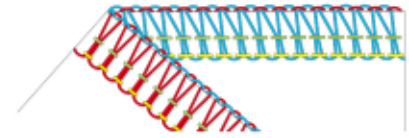

ADJUSTING TENSION SETTINGS FOR BALANCED STITCH

Examine your 4-thread sample. The illustrations below show examples of unbalanced stitches and how to correct the settings to balance the stitch. When making corrections in the tension settings, increase or decrease the settings as needed, moving the dial ½ to 1 number at a time. Stitch a seam using the new settings and then evaluate the new stitch. Continue in this manner until the stitch is balanced.



	<p>UPPER AND LOWER LOOPERS - TIGHT TENSION</p> <p>Unbalanced: The looper threads cause the thread to roll at the edge of the fabric and/or the seam allowance is folded inside the stitch.</p> <p>Correction: Decrease (lower number) one or both looper tensions until the seam allowance is flat and loopers meet at the edge. Note: This problem might also result from an incorrect Cutting Width Setting.</p>
	<p>UPPER LOOPER - LOOSE TENSION</p> <p>Unbalanced: The looper threads are not at the edge of the fabric. Upper Looper thread is visible on the back of the fabric and the looper threads are very loose.</p> <p>Correction: Make sure the thread is seated in the tension guides. If it is, tighten the Upper Looper thread (higher number).</p>
	<p>LOWER LOOPER - LOOSE TENSION</p> <p>Unbalanced: The looper threads do not lock on the edge of the fabric. Lower Looper thread is visible on the face of the fabric. The looper threads are very loose.</p> <p>Correction: Make sure the thread is seated in the tension guides. If it is, tighten the Lower Looper thread (higher number).</p>
	<p>LEFT NEEDLE - LOOSE TENSION</p> <p>Unbalanced: The yellow needle forms loops on the underside of the fabric. The seam is not secure and the yellow thread may show in the seam line.</p> <p>Correction: Make sure the yellow thread is seated in the tension guide. If it is, tighten the Left Needle Tension (higher number).</p>
	<p>RIGHT NEEDLE - LOOSE TENSION</p> <p>Unbalanced: The green needle thread forms loops on the underside of the fabric.</p> <p>Correction: Make sure the green thread is seated in the tension guide. If it is, tighten the Right Needle tension (higher number).</p>
	<p>RIGHT AND LEFT NEEDLES - TIGHT TENSION</p> <p>Unbalanced: The green and yellow needle threads are pulled taut, causing puckers in the fabric at the seam line.</p> <p>Correction: Make sure the threads are seated in the tension guides or have not double-wrapped around a threading guide. If they have, unwrap or loosen appropriate needle tension (lower number).</p>

STITCH LENGTH

-  Firm fabric, 6" x 6"
-  80/12 ELx705
-  4 Spools Serger Thread (B, R, G, Y)
-  4-thread Overlock
-  Standard

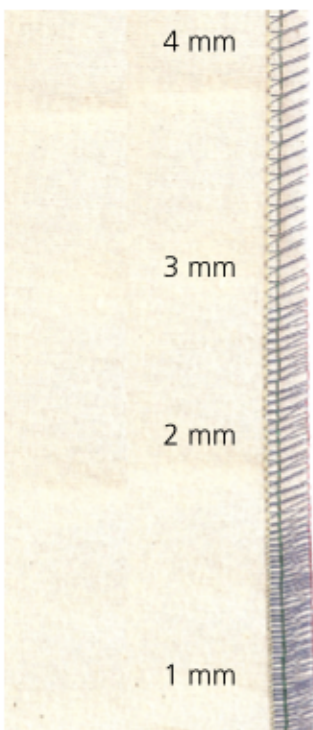
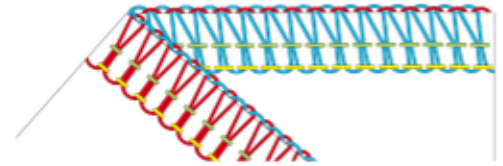

Using the balanced 4-thread Overlock from the previous exercise, follow the instructions below to adjust the Stitch Length.





1. Fold the fabric in half to 3" x 6".
2. Using a fabric marker, divide the fabric into four equal sections along the folded edge.
3. Adjust the Stitch Length to 4 mm. Sew to the first mark along the folded edge, trimming folded edge approximately 1/4".
4. Adjust the Stitch Length to 3 mm and sew to the second mark.
5. Adjust the Stitch Length to 2 mm and sew to the third mark.
6. Adjust the Stitch Length to 1 mm and sew to the end.
7. Mark the Stitch Length settings on the fabric sample.
8. Return Stitch Length to its normal setting of 2.5mm.

NOTE: Stitch Length adjustments may be needed to accommodate thicker or thinner threads or different weights of fabric, as well as being used for decorative effects.

General guidelines for Stitch Length settings	
2.5 mm	Standard setting
1-2 mm	Rolled hems and decorative edges
2.5-4 mm	Heavy weight fabrics
3-4 mm	Gathering and applying elastic

	THREAD TENSION SETTING				MACHINE SETUP			
	LEFT NEEDLE	RIGHT NEEDLE	UPPER LOOPER	LOWER LOOPER	STITCH LENGTH	CUTTING WIDTH	DIFFERENTIAL FEED	ROLLED HEM LEVER
b44	4	4	4	4	1-4	6	1	N
b48	4	4	4	4	1-4	6	1	N
b64	4	4	4	4	1-4	6	1	N
b68	4	4	4	4	1-4	6	1	N
My Settings								

CUTTING WIDTH

-  Firm fabric, 6" x 6"
-  80/12 ELx705
-  4 Spools Serger Thread (B, R, G, Y)
-  4-thread Overlock
-  Standard

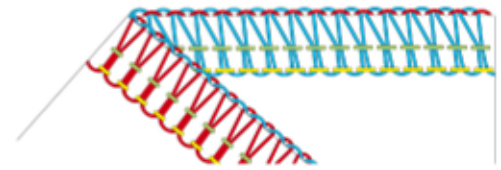

The overlocker should be threaded for a 4-thread Overlock using thread colors to match the Color-coded Threading Path on the overlocker. Adjust all thread tension settings as indicated below, or as previously determined.

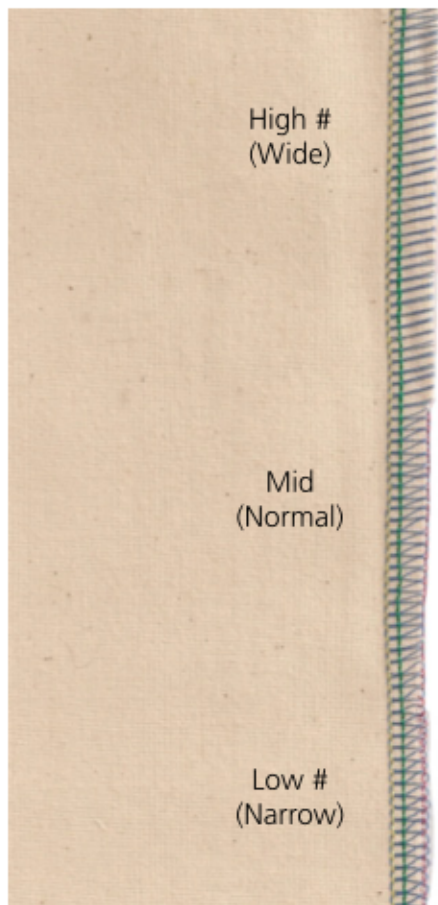



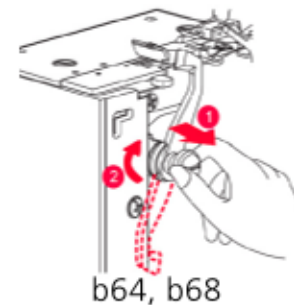
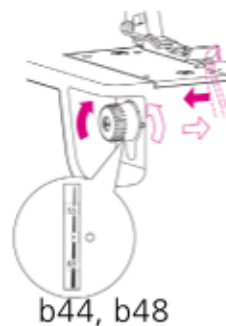

1. Fold the fabric in half to 3" x 6".
2. Using a fabric marker, divide the fabric into three equal sections along the folded edge.
3. Adjust the Cutting Width to the widest setting (6.5) by turning the dial counter clockwise. Sew to the first mark on the fabric, stopping when the knife edge is on the mark.
4. Turn the dial clockwise to adjust the Cutting Width to a mid-range setting (• on b44, 48 and N on b64, 68) and stitch to the second mark.
5. Turn the dial clockwise again to adjust the Cutting Width to the lowest setting (5.5) and stitch to the end of the fabric.
6. Mark the Cutting Width settings on the fabric sample.
7. Return Cutting Width to its normal setting (• or N).



	THREAD TENSION SETTING				MACHINE SETUP			
	LEFT NEEDLE	RIGHT NEEDLE	UPPER LOOPER	LOWER LOOPER	STITCH LENGTH	CUTTING WIDTH	DIFFERENTIAL FEED	ROLLED HEM LEVER
b44	4	4	4	4	2.5	HIGH - LOW	1	N
b48	4	4	4	4	2.5	HIGH - LOW	1	N
b64	4	4	4	4	2.5	HIGH - LOW	1	N
b68	4	4	4	4	2.5	HIGH - LOW	1	N
My Settings								

DIFFERENTIAL FEED: STRETCHY FABRICS

-  Jersey knit, three pieces, 3" x 6"* each
-  80/12 ELx705
-  4 Spools Serger Thread (B, R, G, Y)
-  4-thread Overlock
-  Standard

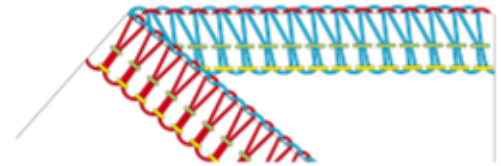

The overlocker should be threaded for a 4-thread Overlock using thread colors to match the Color-coded Threading Path on the machine. Adjust all thread tension settings as indicated below or as previously determined in the earlier exercises.

*Cut jersey knit so that the 6" side has the most stretch.

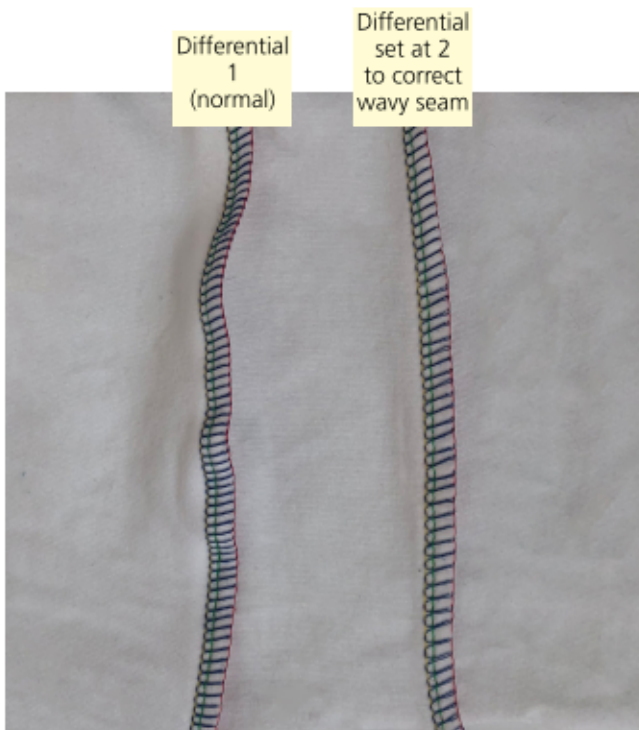

1. With the Differential Feed set at 1 (normal), sew two of the knit pieces together along the stretchy 6" edge. When stitching on fabric that is very stretchy, you may notice that you have a wavy or stretched-out seam when sewing with the Differential Feed Dial at the normal setting.
2. To correct this, adjust the Differential Feed to 2.0. Sew the remaining knit fabric piece to the other side of the first piece, trimming slightly.
3. Mark the Differential Feed settings on the fabric sample.
4. Return Differential Feed Dial to its normal setting of 1.

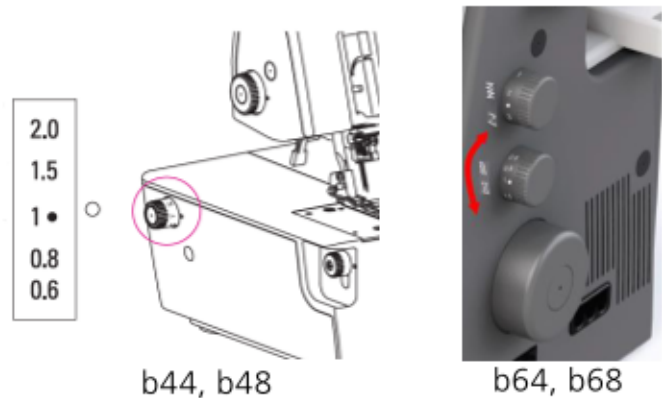





b44, b48

b64, b68

THREAD TENSION SETTING					MACHINE SETUP			
	LEFT NEEDLE	RIGHT NEEDLE	UPPER LOOPER	LOWER LOOPER	STITCH LENGTH	CUTTING WIDTH	DIFFERENTIAL FEED	ROLLED HEM LEVER
b44	4	4	4	4	2.5	6	1-2	N
b48	4	4	4	4	2.5	6	1-2	N
b64	4	4	4	4	2.5	6	1-2	N
b68	4	4	4	4	2.5	6	1-2	N
My Settings								

DIFFERENTIAL FEED: SOFT FABRICS

-  Lightweight tricot, two 4" x 6" pieces
-  80/12 ELx705
-  4 Spools Serger Thread (B, R, G, Y)
-  4-thread Overlock
-  Standard

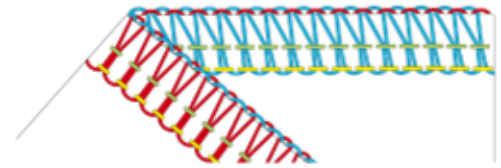

With the overlocker still threaded for a 4-thread Overlock and using thread colors to match the Color-coded Threading Path on the machine, adjust all thread tension settings as indicated in the chart below or as previously determined.

Differential Feed
1 (normal)
Puckering may occur on
lightweight fabrics

Differential Feed
0.6 mm
to correct puckering



1. Place the tricot pieces right sides together. With the Differential Feed set at 1 (normal), stitch along the 6" side of the soft fabric together along one 6" edge, trimming about 1/4" off the edge. When sewing on very lightweight fabric, you may notice that you have a puckered edge.
2. To correct this, adjust the Differential Feed to 0.6. Sew along the other 6" edge, trimming about 1/4" from the edge of the fabric.
3. Mark the Differential Feed settings on the fabric sample.
4. Return Differential Feed Dial to its normal setting of 1.

2.0
1.5
1
0.8
0.6

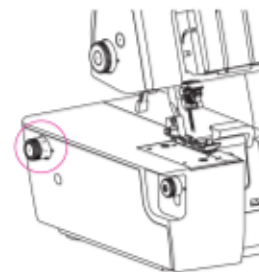





b44, b48

b64, b68

THREAD TENSION SETTING					MACHINE SETUP			
	LEFT NEEDLE	RIGHT NEEDLE	UPPER LOOPER	LOWER LOOPER	STITCH LENGTH	CUTTING WIDTH	DIFFERENTIAL FEED	ROLLED HEM LEVER
b44	4	4	4	4	2.5	6	1-6	N
b48	4	4	4	4	2.5	6	1-6	N
b64	4	4	4	4	2.5	6	1-6	N
b68	4	4	4	4	2.5	6	1-6	N
My Settings								

PRESSER FOOT PRESSURE

-  Polar fleece, three 3" x 6" pieces
-  80/12 ELx705
-  4 Spools Serger Thread (B, R, G, Y)
-  4-thread Overlock
-  Standard

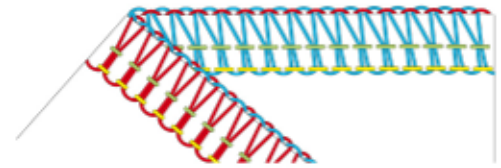

With the overlocker still threaded for a 4-thread Overlock and using thread colors to match the Color-coded Threading Path on the machine, adjust all thread tension settings as indicated in the chart below or as previously determined.

Note: The Presser Foot Pressure of the machine is pre-adjusted at the factory to suit the sewing of medium weight fabrics. Most fabrics do not require adjustment of the Presser Foot Pressure.

However, there are some instances where adjustment is necessary, such as when sewing light weight or heavy weight fabrics.

1. With Presser Foot Pressure set to "L", sew two layers of fleece together along the 6" side.
2. Adjust Presser Foot Pressure to "H" and sew the remaining layer of fleece to the other 6" side of the fabric used in previous step.
3. Determine which Presser Foot Pressure setting resulted in more even feeding of the material through the machine.
4. Return the Presser Foot Pressure to the normal setting.



b44, b48



b64, b68

	THREAD TENSION SETTING				MACHINE SETUP				
	LEFT NEEDLE	RIGHT NEEDLE	UPPER LOOPER	LOWER LOOPER	STITCH LENGTH	CUTTING WIDTH	DIFFERENTIAL FEED	ROLLED HEM LEVER	PRESSER FOOT PRESSURE
b44	4	4	4	4	2.5	6	1	N	L TO H
b48	4	4	4	4	2.5	6	1	N	L TO H
b64	4	4	4	4	2.5	6	1	N	L TO H
b68	4	4	4	4	2.5	9	1	N	L TO H
My Settings									

3-THREAD OVERLOCK STITCH-WIDE

-  Firm fabric, 6" x 6"
-  80/12 ELx705
-  3 Spools Serger Thread (Y, R, B)
-  3-thread Overlock (wide)
-  Standard

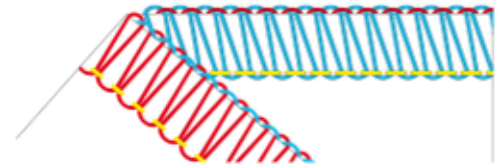

For this exercise, the overlocker will be threaded for a wide 3-thread Overlock using only the Left Needle and thread colors to match the Color-coded Threading Path on the overlocker. Adjust all thread tension settings for a balanced stitch as indicated in chart below.

1. Using the small screwdriver and Needle Inserter/Threader Tool, remove the Right Needle and thread. Tighten the Needle Set Screw after removing the Right Needle. The Left Needle will remain threaded.
2. Fold fabric in half to 3" x "6". Stitch along the folded edge of the fabric, trimming 1/4".

THREAD TENSION SETTING					MACHINE SETUP			
	LEFT NEEDLE	RIGHT NEEDLE	UPPER LOOPER	LOWER LOOPER	STITCH LENGTH	CUTTING WIDTH	DIFFERENTIAL FEED	ROLLED HEM LEVER
b44	3	-	4	3.5	2.5	6	1	N
b48	4	-	4.5	3.5	2.5	6	1	N
b64	4	-	4	4	2.5	6	1	N
b68	4	-	4	4	2.5	6	1	N
My Settings								

3-THREAD FLATLOCK–WIDE

-  Firm fabric, 6" x 6"
-  80/12 ELx705
-  3 Spools Serger Thread (Y, B, R)
-  3-thread Flatlock (wide)
-  Standard

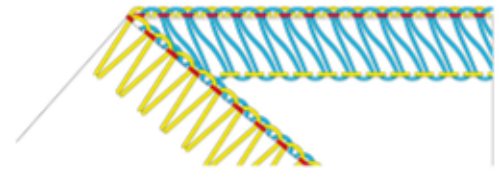

For this exercise, the overlocker will be threaded for a wide 3-thread Flatlock using the Left Needle and thread colors to match the Color-coded Threading Path on the overlocker. Adjust all thread tension settings for a Flatlock Stitch as indicated in chart below.

Note: If following instructions in the Mastery book, the Right Needle was removed in the previous exercise, so you will skip Step 1.



Decorative Thread Tip: A heavy thread such as YLI Jeans Stitch, Pearl Crown Rayon, or Designer 6 can be used in the looper for a more decorative look. When working with heavy decorative threads, loosen the Upper Looper tension and lengthen the Stitch Length as needed for the desired look.

1. Using the small screwdriver and Needle Threader/ Inserter, insert the Left Needle and remove the Right Needle. Tighten the Needle Set Screw after inserting or removing needles.
2. Fold the fabric in half, wrong sides together, to 3" x 6".
3. Place the fold under the Presser Foot. Guide the fabric halfway between the Left Needle and the right edge of the Stitch Finger. This method allows the fabric to lay totally flat under the stitches.

Optionally, you may choose to trim the folded edge which will allow one fabric to lay on top of the other. This is the preferred method if using the flatlock stitch as a seam.
4. Slowly sew the fabric. The looper threads will extend beyond the fabric on the right side of fold.
5. Gently pull the fabric flat.

	THREAD TENSION SETTING				MACHINE SETUP			
	LEFT NEEDLE	RIGHT NEEDLE	UPPER LOOPER	LOWER LOOPER	STITCH LENGTH	CUTTING WIDTH	DIFFERENTIAL FEED	ROLLED HEM LEVER
b44	0	-	4	7.5	2.5	6	1	N
b48	0	-	4.5	7.0	2.5	6	1	N
b64	0	-	5	8	2.5	5.5	1	N
b68	0	-	5	8	2.5	6.5	1	N
My Settings								

3-THREAD OVERLOCK STITCH–NARROW

-  Firm fabric, 6" x 6"
-  80/12 ELx705
-  4 Spools Serger Thread (G, R, B)
-  3-thread Narrow Seam
-  Standard

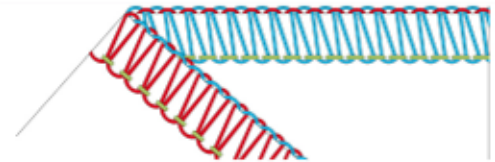

For this exercise, you will thread the overlocker for a 3-thread Narrow Seam using the Right Needle and thread colors to match the Color-coded Threading Path on the overlocker. Adjust all thread tension settings for a balanced stitch as indicated below.

Note: If following instructions in the Mastery book, the Right Needle was removed in the previous exercise. You will now be inserting the Right Needle and removing the Left Needle to complete this exercise.

1. Using the small screwdriver and Needle Threader/ Inserter, loosen the Right Needle Set Screw and insert the Right Needle. Tighten the Needle Set Screw. Thread the needle.
2. Remove the Left Needle thread. Loosen the Left Needle Set Screw and remove the Left Needle.
3. Fold the fabric in half to a 3" x 6" rectangle and stitch along the fold of the fabric, trimming 1/4".
4. Using this same stitch, finish edge of one 6" side of the fabric to see how the stitch looks on a single layer.

THREAD TENSION SETTING					MACHINE SETUP			
	LEFT NEEDLE	RIGHT NEEDLE	UPPER LOOPER	LOWER LOOPER	STITCH LENGTH	CUTTING WIDTH	DIFFERENTIAL FEED	ROLLED HEM LEVER
b44	-	4	4	4	2.5	6	1	N
b48	-	4.5	4.5	4	2.5	6	1	N
b64	-	4.5	4	4	2.5	6	1	N
b68	-	4.5	4	4	2.5	6	1	N
My Settings								

3-THREAD FLATLOCK–NARROW

-  Firm fabric, 6" x 6"
-  80/12 ELx705
-  3 Spools Serger Thread (G, B, R)
-  3-thread Flatlock (narrow)
-  Standard

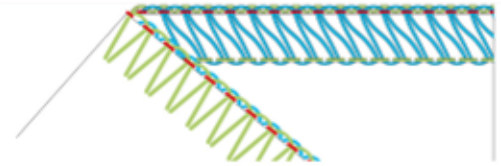

For this exercise, the overlocker will be threaded for a narrow 3-thread Flatlock using the Right Needle and thread colors to match the Color-coded Threading Path on the overlocker. Adjust all thread tension settings for a 3-thread Flatlock Stitch as indicated in chart below.







Note: If following instructions in the Mastery book, the Right Needle was inserted and threaded, and the Left Needle and thread were removed in the previous exercise. If so, you will skip Steps 1 and 2.

1. Using the small screwdriver and Needle Threader/ Inserter, loosen the Right Needle Set Screw and insert the Right Needle. Tighten the Right Needle Set Screw. Thread the needle.
 2. Remove the Left Needle thread. Loosen the Left Needle Set Screw and remove the Left Needle.
 3. Fold the fabric in half, wrong sides together, to 3" x 6".
 4. Place the fold under the Presser Foot. Guide the fabric halfway between the Left Needle and the right edge of the Stitch Finger. This method allows the fabric to lay totally flat under the stitches.
- Optionally, you may choose to trim the folded edge which will allow one fabric to lay on top of the other. This is the preferred method if using the a flatlock stitch as a seam.
5. Slowly sew the fabric. The looper threads will extend beyond the fabric on the right side of fold.
 6. Gently pull the fabric flat.

Decorative Thread Tip: A heavy thread such as YLI Jeans Stitch, Pearl Crown Rayon, or Designer 6 can be used in the looper for a more decorative look. When working with heavy decorative threads, loosen the Upper Looper tension and lengthen the Stitch Length as needed for the desired look.

	THREAD TENSION SETTING				MACHINE SETUP			
	LEFT NEEDLE	RIGHT NEEDLE	UPPER LOOPER	LOWER LOOPER	STITCH LENGTH	CUTTING WIDTH	DIFFERENTIAL FEED	ROLLED HEM LEVER
b44	-	0	4.5	7.5	2.5	6	1	N
b48	-	0	4.5	6.5	2.5	6	1	N
b64	-	0	6.5	8	2.5	6	1	N
b68	-	0	6.5	8	2.5	5.5	1	N
My Settings								

3-THREAD ROLLED HEM

-  Light weight fabric, 4" x 6"
-  80/12 ELx705
-  3 Spools serger thread (B, R, G)
-  3-thread Rolled Hem
-  Standard

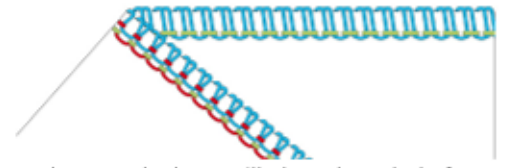

For this exercise, the overlocker will be threaded for a narrow 3-thread Rolled Hem using the Right Needle. Thread with colors to match the Color-coded Threading Path on the overlocker. Adjust all thread tension settings for a Rolled Hem as indicated in chart below.



Note: If following instructions in the Mastery book, the Right Needle was inserted and threaded, and the Left Needle and thread were removed in a previous exercise. If so, you will skip Steps 1 and 2.

1. Using the small screwdriver and Needle Inserter/Threader, loosen the Right Needle Set Screw and insert the needle. Tighten the Right Needle Set Screw. Thread the needle.
2. Remove the Left Needle thread. Loosen the Left Needle Set Screw and remove the Left Needle.
3. Disengage the Stitch Finger by placing the Rolled Hem Selection Lever in the "R" position..
4. Start the machine and run a chain for several inches so that you have a thread tail to aid in getting the fabric started.
5. Place the fabric under the Presser Foot and sew along one 6" edge.
6. Return Stitch Length and thread tensions to their normal setting.
7. Return the Rolled Hem Selection Lever to normal sewing position.





Optional: Thread the Upper Looter **texturized nylon thread** in the Upper Looter. Loosen the Upper Looter tension slightly from the settings listed below.

- The Rolled Hem Selection Lever moves the Stitch Finger in and out of position.
- Push the lever forward (N) for normal sewing so the stitch can form over it, keeping the fabric flat.
- Pull the lever toward you (R) so the fabric edge can roll when stitching a rolled edge.



	THREAD TENSION SETTING				MACHINE SETUP			
	LEFT NEEDLE	RIGHT NEEDLE	UPPER LOOPER	LOWER LOOPER	STITCH LENGTH	CUTTING WIDTH	DIFFERENTIAL FEED	ROLLED HEM LEVER
b44	-	4.5	4.5	6.5	1	5	1	R
b48	-	4	4	6	1	5	1	R
b64	-	5	5	7	1.5	5	1	R
b68	-	4.5	5	7	1.5	5	1	R
My Settings								

2-THREAD ROLLED HEM

-  Light weight fabric, 4" x 6"
-  80/12 ELx705
-  2 Spools Serger Thread (red, green)
-  2-thread Rolled Hem
-  Standard

Accessory: Upper Loper Converter

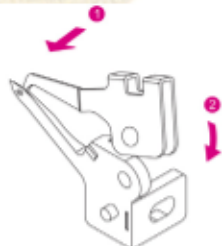
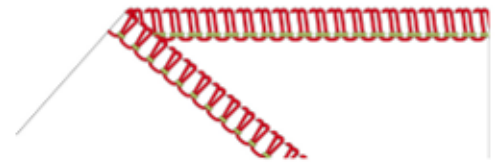

- To engage the Upper Loper Converter, insert the sharp part (1) into the eye of the Upper Loper.
- A raised point located in the trough of the Upper Loper must be inserted and fixed (2) in the eye of the Upper Loper Converter.





For this exercise, the overlocker will be threaded for a 2-thread Rolled Hem using the Right Needle and threaded with colors to match the Color-coded Threading Path on the overlocker. Adjust all thread tension settings for a 2-thread Rolled Hem as indicated in chart below.

Note: If following instructions in the Mastery book, the Right Needle was inserted and threaded, and the Left Needle and thread were removed in the previous exercise. If so, you will skip Steps 1 and 2.

1. Using the small screwdriver and Needle Threader/Inserter, loosen the Right Needle Set Screw and insert the Right Needle. Tighten the Right Needle Set Screw. Thread the needle.
2. Remove the Left Needle thread. Loosen the Left Needle Set Screw and remove the Left Needle.
3. Attach the Upper Loper Converter to the Upper Loper. See Diagram below.
4. Disengage the Stitch Finger by placing the Rolled Hem Selection Lever in the "R" position.
5. Start the machine and run a chain for several inches so that you have a thread tail to hold as an aid in getting the fabric started.
6. Place the fabric under the Presser Foot and sew along one 6" edge, trimming about 1/4" from the raw edge.
7. Return Stitch Length and thread tensions to their normal setting.
8. Return the Rolled Hem Selection Lever to normal sewing position.

	THREAD TENSION SETTING				MACHINE SETUP			
	LEFT NEEDLE	RIGHT NEEDLE	UPPER LOOPER	LOWER LOOPER	STITCH LENGTH	CUTTING WIDTH	DIFFERENTIAL FEED	ROLLED HEM LEVER
b44	-	4.5	CONVERTER	4	1	5	1	R
b48	-	4.5	CONVERTER	4	1	5	1	R
b64	-	5	CONVERTER	4.5	1.5	5.5	1	R
b68	-	5	CONVERTER	4.5	1.5	5.5	1	R
My Settings								

2-THREAD FLATLOCK–NARROW

-  Firm fabric, 6" x 6"
-  80/12 ELx705
-  3 Spools Serger Thread (red, yellow)
-  2-Thread Flatlock (narrow)
-  Standard

Accessory: Upper Looper Converter

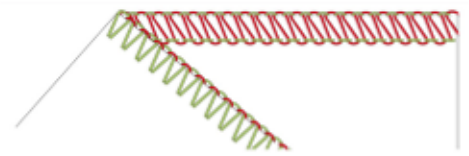





Thread the overlocker for a narrow 2-thread Flatlock using the Right Needle and threaded with colors to match the Color-coded Threading Path on the overlocker. Adjust all thread tension settings for a 2-thread Flatlock as indicated in chart below.

Note: If following instructions in the Mastery book, the Right Needle was inserted and threaded, and the Left Needle and thread were removed in the previous exercise. If so, you will skip Steps 1 and 2.

1. Using the small screwdriver and Needle/Threader Inserter, insert the Left Needle. Remove the Right Needle. Tighten the Needle Set Screw after removing the needle.
2. Attach the Upper Looper Converter to the Upper Looper.
3. Fold the fabric in half to 3" x 6". Place the fold under the Presser Foot. Guide the fabric halfway between the Left Needle and the right edge of the Stitch Finger. This method allows the fabric to lay totally flat under the stitches.
Optionally, you may choose to trim the folded edge which will allow one fabric to lay on top of the other. This is the preferred method if using a flatlock stitch as a seam.
4. Slowly stitch the fabric. The looper threads will extend beyond the fabric on the right side of fold.
5. Gently pull the fabric flat. Note: Before the fabric is pulled flat to create the flatlock stitch, the threads form a 2-thread balanced stitch with the threads connecting at the edge of the fabric. This stitch is not strong enough for seaming, but can be used as an edge finish for light to medium weight fabrics.
6. Using the small screwdriver and Needle Threader/Inserter, insert the Left Needle. Tighten the Needle Set Screw after inserting the needle.
7. Remove the Upper Looper Converter. Return Stitch Length and thread tension dials to normal.
8. Rethread the loopers and both needles.

THREAD TENSION SETTING					MACHINE SETUP			
	LEFT NEEDLE	RIGHT NEEDLE	UPPER LOOPER	LOWER LOOPER	STITCH LENGTH	CUTTING WIDTH	DIFFERENTIAL FEED	ROLLED HEM LEVER
b44	-	0	CONVERTER	4.5	2.5	6	1	N
b48	-	0	CONVERTER	4.5	2.5	6	1	N
b64	-	3	CONVERTER	7.5	2.5	6	1	N
b68	-	3	CONVERTER	7.5	2.5	6	1	N
My Settings								

OVERLOCKER TECHNIQUES: SECURING SEAMS

-  Firm fabric, 6" x 6"
-  80/12 ELx705
-  4 Spools Serger Thread (B, R, G, Y)
-  4-thread Overlock
-  Standard

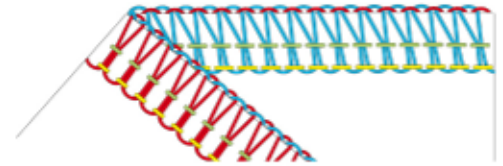





Thread the overlocker for a 4-thread Overlock using thread colors to match the Color-coded Threading Path on the machine. Adjust all thread tension settings as indicated in the chart below.

1. Sew a 2"-3" thread chain without fabric.
2. Fold fabric in half to 3" x "6" and place under the Presser Foot.
3. Take 2-3 stitches on the fabric. Lower the needles into the fabric. Raise the Presser Foot, and with your left hand gently pull the thread chain around and in front of the needles to the knife.
4. Lower the Presser Foot and sew over the thread chain approximately 1", and then trim the thread chain with the knife.
5. Continue stitching. At the end of the fabric, sew just off the edge of the fabric. Carefully pull the threads off the Stitch Finger by placing the Rolled Hem Selection Lever in the "R" position temporarily.
6. Raise the Presser Foot and carefully turn the fabric over so that the Lower Looper side of the previously stitched seam will be overstepped.
7. Place the fabric under the Presser Foot so that the first stitch will enter the fabric when you begin stitching.
8. Engage the Stitch Finger by placing the Rolled Hem Selection Lever back in the "N" position..
9. Sew for about 1", overstepping the previous stitching. Guide the fabric so as not to cut the previous stitching.
10. Raise the toe of the Presser Foot and rotate the fabric 90° clockwise.
11. Stitch off the edge of the fabric.



THREAD TENSION SETTING					MACHINE SETUP			
	LEFT NEEDLE	RIGHT NEEDLE	UPPER LOOPER	LOWER LOOPER	STITCH LENGTH	CUTTING WIDTH	DIFFERENTIAL FEED	ROLLED HEM LEVER
b44	4	4	4	4	2.5	6	1	N-R
b48	4	4	4	4	2.5	6	1	N-R
b64	4	4	4	4	2.5	6	1	N-R
b68	4	4	4	4	2.5	6	1	N-R
My Settings								

OVERLOCKER TECHNIQUES: INSIDE CORNER

-  Firm fabric, 6" x 6"
-  80/12 ELx705
-  3 Spools Serger Thread (B, R, Y, G)
-  4-thread Overlock
-  Standard

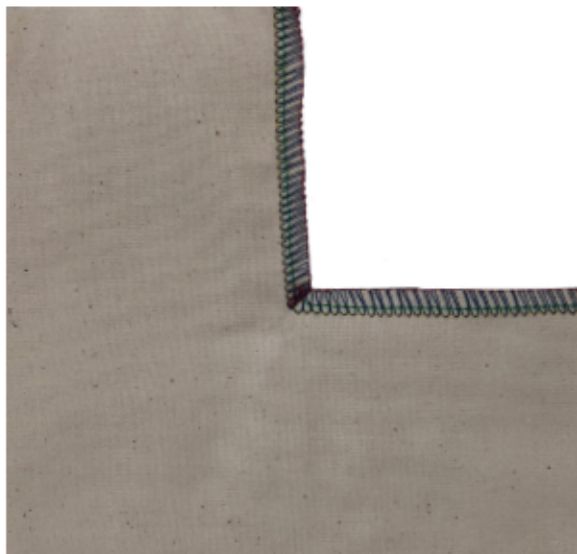
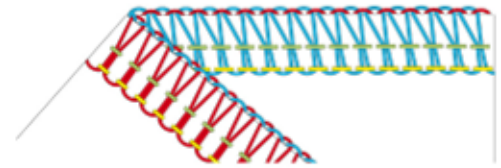

Thread the overlocker for a 4-thread Overlock using thread colors to match the Color-coded Threading Path on the machine. Adjust all thread tension settings as indicated in the chart below.

INSIDE CORNER



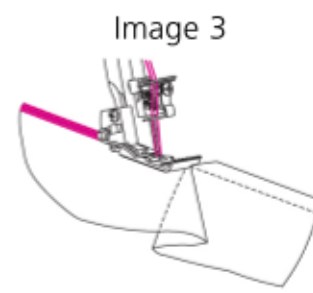
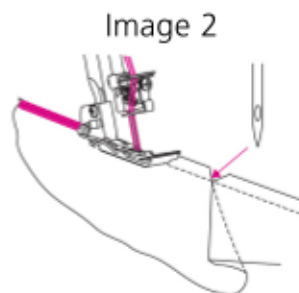
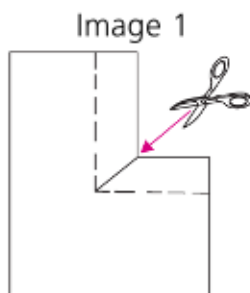

NOTE: This technique works well for continuous plackets on sleeves and back neck openings.

1. Cut an inside corner into the fabric.
2. Snip into the corner about ¼" (the width of the stitching). See Image 1.
3. Sew until the knife reaches the end of the cut.
4. Use the Handwheel to lower the needle into the fabric.
5. Lift the Presser Foot and straighten the corner placing the fabric in front of the Presser Foot. See Image 2.
6. Lower the Presser Foot; continue sewing in a straight line. See Image 3.



THREAD TENSION SETTING					MACHINE SETUP			
	LEFT NEEDLE	RIGHT NEEDLE	UPPER LOOPER	LOWER LOOPER	STITCH LENGTH	CUTTING WIDTH	DIFFERENTIAL FEED	ROLLED HEM LEVER
b44	4	4	4	4	2.5	6	1	N-R
b48	4	4	4	4	2.5	6	1	N-R
b64	4	4	4	4	2.5	6	1	N-R
b68	4	4	4	4	2.5	6	1	N-R
My Settings								

OVERLOCKER TECHNIQUES: OUTSIDE CORNER

-  Firm fabric, two 6" x 6" pieces
-  80/12 ELx705
-  4 Spools Serger Thread (B, R, Y, G)
-  4-thread Overlock
-  Standard

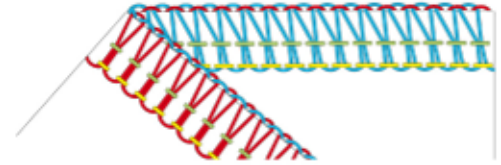

Thread the overlocker for a 4-thread Overlock using thread colors to match the Color-coded Threading Path on the machine. Adjust all thread tension settings as indicated in the chart below.

OUTSIDE CORNER: OPTION 1



OUTSIDE CORNER: OPTION 1

1. Sew one edge of the fabric, sewing off the end of the fabric.
2. Continue stitching around the square, crossing over previous stitching.
3. Use a seam sealant on the untrimmed thread tails (or use a tapestry needle to weave the thread tail back through the stitching). When the seam sealant is dry, trim the thread tails.

OUTSIDE CORNER: OPTION 2







OUTSIDE CORNER: OPTION 2

1. Before sewing, trim away the seam allowance (1/4") for about 2" on each corner of the square.
2. Beginning at one trimmed corner, stitch (trimming very slightly as you sew) to the end of the fabric. Take one stitch off the end of the fabric.
3. Release the Stitch Finger by placing the Rolled Hem Selection Lever into the "R" position.
4. Lift the Presser Foot and carefully pivot the fabric 90° clockwise.
5. Engage the Stitch Finger by returning the Rolled Hem Selection Lever to the "N" position.
6. Place the needle one stitch into the fabric and lower the Presser Foot.
7. Continue sewing until you are one stitch off the next corner. Repeat the turning procedure and continue stitching.

THREAD TENSION SETTING					MACHINE SETUP			
	LEFT NEEDLE	RIGHT NEEDLE	UPPER LOOPER	LOWER LOOPER	STITCH LENGTH	CUTTING WIDTH	DIFFERENTIAL FEED	ROLLED HEM LEVER
b44	4	4	4	4	2.5	6	1	N-R
b48	4	4	4	4	2.5	6	1	N-R
b64	4	4	4	4	2.5	6	1	N-R
b68	4	4	4	4	2.5	6	1	N-R
My Settings								

OVERLOCKER TECHNIQUES: DIFFERENTIAL FEED AND GATHERING

-  Lightweight woven fabric, 3" x 12"
-  80/12 ELx705
-  4 Spools Serger Thread (B, R, Y, G)
-  4-thread Overlock
-  Standard

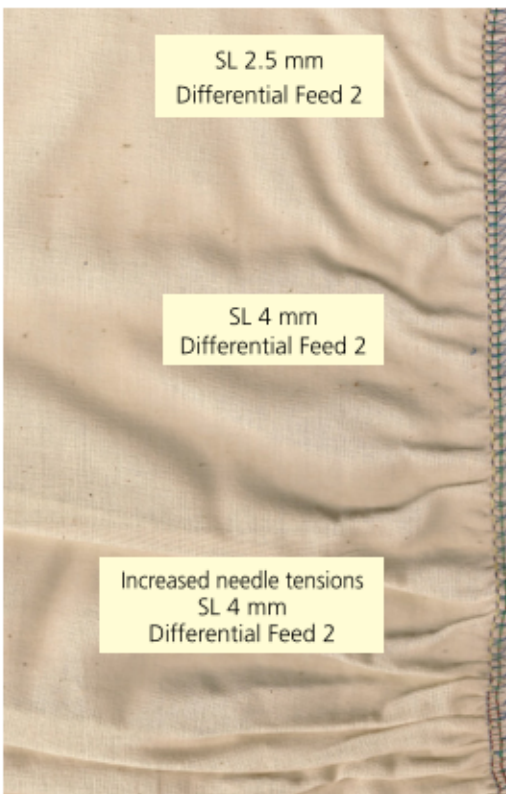
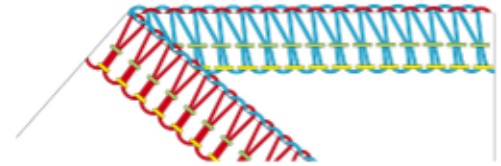

1. Thread the overlocker for a 4-thread Overlock using thread colors to match the Color-coded Threading Path on the machine. Adjust all thread tension settings as indicated in the following steps.
2. Using a fabric marker, divide the fabric into 3 equal sections along one 12" side.
3. Turn the Differential Feed Dial to 2. Sew to the first mark.
4. Adjust Stitch Length to 4 mm and sew to the second mark.
5. Move both Thread Tension Dials up to 8 to increase both needle thread tensions. Sew to the end of the fabric.
6. Return Differential Feed Dial setting to its normal setting of 1. Set the Stitch Length to 2.5.
7. Move the Thread Tension Dials to return tensions to normal

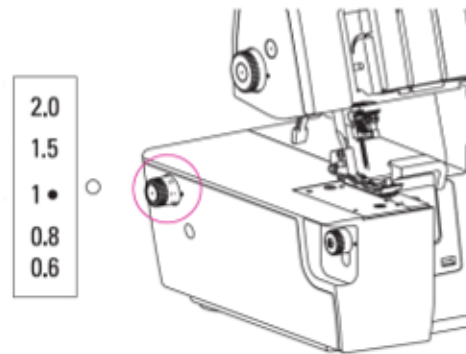

THREAD TENSION SETTING					MACHINE SETUP			
	LEFT NEEDLE	RIGHT NEEDLE	UPPER LOOPER	LOWER LOOPER	STITCH LENGTH	CUTTING WIDTH	DIFFERENTIAL FEED	ROLLED HEM LEVER
b44	4-8	4-8	4	4	2.5-4	6	1	N
b48	4-8	4.8	4	4	2.5-4	6	1	N
b64	4-8	4.8	4	4	2.5-4	6	1	N
b68	4-8	4.8	4	4	2.5-4	6	1	N
My Settings								

SUPPLIES

NEEDLES AND THREADS
80/12 ELX705 Serger Needles (2 come with machine)
4 Spools Serger Thread (blue, red, green, yellow)
Texturized nylon thread (optional)
Pearl Crown Rayon thread (optional)

FABRICS FOR EXERCISES PAGES 6 THROUGH 19		
QUANTITY	SIZE	FABRIC
8	6" x 6"	Firm Fabric such as: <ul style="list-style-type: none"> • Heavy muslin • High-quality quilting cotton • Medium weight denim
3	3" x 6"	Jersey knit
4	4" x 6"	Lightweight tricot/fabric
3	3" x 6"	Fleece

FABRICS FOR OPTIONAL OVERLOCKER TECHNIQUE PAGES 20 THROUGH 23		
QUANTITY	SIZE	FABRIC
4	6" x 6"	Firm Fabric such as: <ul style="list-style-type: none"> • Heavy muslin • High-quality quilting cotton • Medium weight denim
1	3" x 12"	Lightweight Fabric