

HERMAN SERIES

PRODUCT INFO



ferm
L I V I N G



HERMAN SERIES

The Herman series merges modern aesthetics with functionality. The Herman Chair was originally designed in 2013 by the Danish design duo Herman Studio, and has since 2015 been produced by ferm LIVING.

Since then, a number of products have been born into the Herman family, including a bar chair, stool, lounge chair, as well as laundry and magazine stands. In the series, clean lines and a contemporary aesthetic are met with simple functionality that make for classic pieces that are easy to integrate into any interior space.

PRODUCT DETAILS

| | |
|------------------------|-------------------------------------|
| Product type: | Chair for indoor use |
| Sustainability: | FSC™ Mix-certified |
| Origin: | Latvia |
| Design: | In collaboration with Herman Studio |





Herman Dining Chair with Wooden frame – Black

HERMAN DINING CHAIR - WOODEN FRAME

In collaboration with Herman Studio

PRODUCT DETAILS

Manufactured in Latvia
Registered design

DIMENSIONS

Height: 74 cm / 29.1 in
Width: 50 cm / 19.7 in
Depth: 47 cm / 18.5 in
Seat height: 45 cm / 17.7 in
Weight: 4.8 kg (oak/ash veneer)
5 kg (with upholstery)

MATERIALS & CONSTRUCTION

Backrest/seat: Natural oak or painted ash veneer
Upholstered seat: Birch veneer upholstered with fabric or leather
Frame: Natural solid oak or painted solid ash
Glides: Plastic or felt glides
FSC™ Mix-certified wood

CARE

Please see Care & Maintenance guide on www.fermliving.com

PACKSIZE

2

TEST

EN 16139:2013

Furniture - Strength, durability, stability and safety
Requirements for non-domestic seating

Foam fire rating:

CAL117-2013 - pass
BS 5852 Crib5 - pass

STOCK VERSIONS



1104263815
Black

1104263538
Natural Oak

1104263816
Red Brown

1104263814
Warm Grey

CUSTOMISATION OPTIONS

FRAME & BACKREST OPTIONS

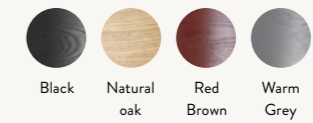

LEATHER QUALITIES (SEAT ONLY)



FABRIC QUALITIES (SEAT ONLY)

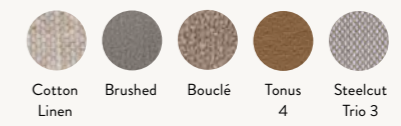

To see the specifications of each fabric and available colour assortment please go to overview on page 20
Felt Gliders must be ordered separately against price supplement

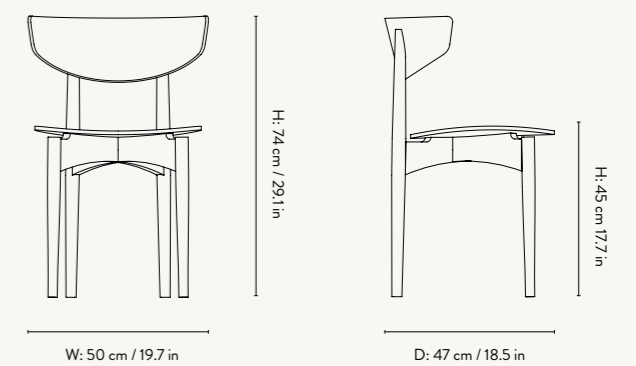

W: 50 cm / 19.7 in

D: 47 cm / 18.5 in

H: 45 cm / 17.7 in



Herman Dining Chair with Chrome frame – White Oiled Oak

HERMAN DINING CHAIR - STEEL FRAME

In collaboration with Herman Studio

PRODUCT DETAILS

Manufactured in Latvia
Registered design

DIMENSIONS

Height: 74 cm / 29.1 in
Width: 50 cm / 19.7 in
Depth: 47 cm / 18.5 in
Seat height: 45 cm / 17.7 in
Weight: 4.8 kg (oak/ash veneer)
5 kg (with upholstery)

MATERIALS & CONSTRUCTION

Backrest/seat: White oiled oak, dark stained oak, walnut or painted ash veneer
Upholstered seat: Birch veneer upholstered with fabric or leather
Frame: Black powder or chrome coated steel
Glides: Plastic or felt glides
FSC™ Mix-certified wood

CARE

Please see Care & Maintenance guide on www.fermliving.com

PACKSIZE

2

TEST

EN 16139:2013

Furniture - Strength, durability, stability and safety
Requirements for non-domestic seating

Foam fire rating:

CAL117-2013 - pass
BS 5852 Crib5 - pass

STOCK VERSIONS

BLACK FRAME



CHROME FRAME

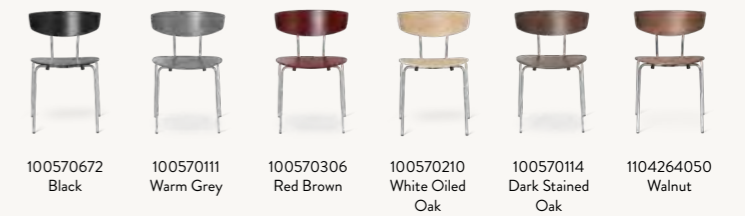

CUSTOMISATION OPTIONS

BACKREST & SEAT OPTIONS



FRAME OPTIONS



LEATHER QUALITIES (SEAT ONLY)



FABRIC QUALITIES (SEAT ONLY)



To see the specifications of each fabric and available colour assortment please go to overview on page 20
Felt Gliders must be ordered separately against price supplement

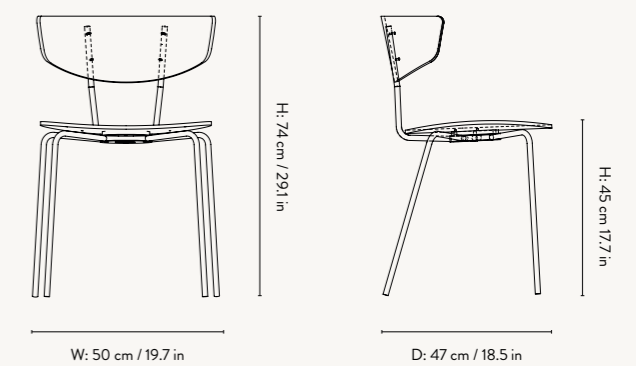



Herman Stool – Black frame – Dark Stained Oak

HERMAN STOOL

In collaboration with Herman Studio

PRODUCT DETAILS

Manufactured in Latvia

DIMENSIONS

Height: 45 cm / 16.9 in
 Width: 35.5 cm / 13.9 in
 Depth: 30.5 cm / 12 in
 Seat height: 45 cm / 17.7 in
 Weight: 2.9 kg (oak/ash veneer)
 3 kg (with upholstery)

MATERIALS & CONSTRUCTION

Seat: White oiled oak, dark stained oak, walnut or painted ash veneer
 Upholstered seat: Birch veneer upholstered with fabric or leather
 Frame: Black powder or chrome coated steel.
 Glides: Plastic or felt glides
 FSC™ Mix-certified wood (except black and warm grey with chrome frame)

CARE

Please see Care & Maintenance guide on www.fermliving.com

PACKSIZE

2

TEST

[EN 16139-2013](http://EN16139-2013)

Furniture - Strength, durability, stability and safety
 Requirements for non-domestic seating

Foam fire rating:

CAL117-2013 - pass
 BS 5852 Crib5 - pass

STOCK VERSIONS

BLACK FRAME



CHROME FRAME



CUSTOMISATION OPTIONS

SEAT OPTIONS



FRAME OPTIONS



LEATHER QUALITIES (SEAT ONLY)



FABRIC QUALITIES (SEAT ONLY)



To see the specifications of each fabric and available colour assortment please go to overview on page 20
 Felt Gliders must be ordered separately against price supplement

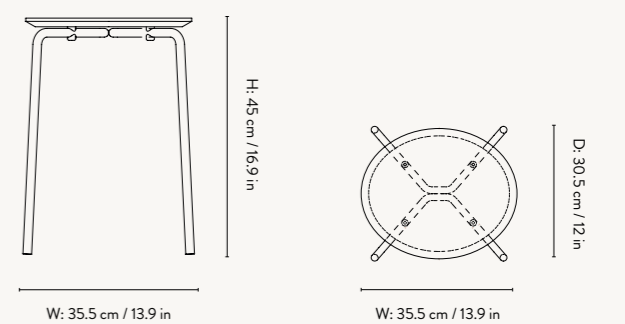



Herman Counter Chair in Black

HERMAN COUNTER CHAIR

In collaboration with Herman Studio

PRODUCT DETAILS

Manufactured in Latvia
Registered design

DIMENSIONS

Height: 87 cm / 34.3 in
Width: 39.6 cm / 15.5 in
Depth: 39.4 cm / 15.5 in
Seat height: 64 cm / 25 in
Weight: 4.9 kg (ash veneer)
5.1 kg (with upholstery)

MATERIALS & CONSTRUCTION

Backrest/seat: White oiled oak or painted ash veneer
Upholstered seat: Birch veneer upholstered with fabric or leather
Frame: Black powder coated steel
Glides: Plastic or felt glide
FSC™ Mix-certified wood

CARE

Please see Care & Maintenance guide on www.fermliving.com

PACKSIZE

1

TEST

EN 16139:2013

Furniture - Strength, durability, stability and safety
Requirements for non-domestic seating

Foam fire rating:

CAL117-2013 - pass
BS 5852 Crib5 - pass

STOCK VERSIONS



CUSTOMISATION OPTIONS

BACKREST & SEAT OPTIONS

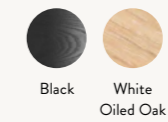

FRAME OPTION



LEATHER QUALITIES (SEAT ONLY)



FABRIC QUALITIES (SEAT ONLY)



To see the specifications of each fabric and available colour assortment please go to overview on page 20
Felt Gliders must be ordered separately against price supplement

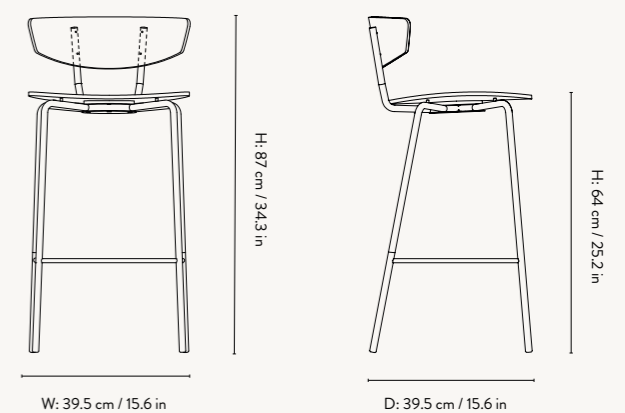

W: 39.5 cm / 15.6 in

D: 39.5 cm / 15.6 in



Herman Bar Chair with Black frame - White Oiled Oak

HERMAN BAR CHAIR

In collaboration with Herman Studio

PRODUCT DETAILS

Manufactured in Latvia
Registered design

DIMENSIONS

Height: 96 cm / 37.8 in
Width: 40.5 cm / 15.7 in
Depth: 43 cm / 16.9 in
Seat height: 76 cm / 29.9 in
Weight: 5.3 kg (ash veneer)
5.1kg (with upholstery)

MATERIALS & CONSTRUCTION

Backrest/seat: White oiled oak or painted ash veneer
Upholstered seat: Birch veneer upholstered with fabric or leather
Frame: Black powder coated steel
Glides: Plastic or felt glide
FSC™ Mix-certified wood

CARE

Please see Care & Maintenance guide on www.fermliving.com

PACKSIZE

1

TEST

EN 16139:2013
Furniture - Strength, durability, stability and safety
Requirements for non-domestic seating

Foam fire rating:
CAL117-2013 - pass
BS 5852 Crib5 - pass

STOCK VERSIONS



CUSTOMISATION OPTIONS

BACKREST & SEAT OPTIONS

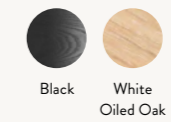

FRAME OPTION



LEATHER QUALITIES (SEAT ONLY)



FABRIC QUALITIES (SEAT ONLY)



To see the specifications of each fabric and available colour assortment please go to overview on page 20
Felt Gliders must be ordered separately against price supplement

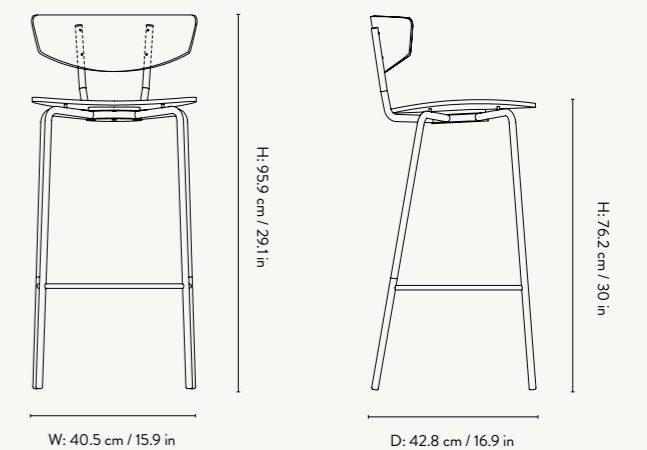



Herman Lounge Chair in Black

HERMAN LOUNGE CHAIR

In collaboration with Herman Studio

PRODUCT DETAILS

Manufactured in Latvia
Registered design

DIMENSIONS

Height: 68 cm / 26.8 in
Width: 68 cm / 26.8 in
Depth: 60 cm / 23.6 in
Seat height: 37 cm / 14.6 in
Weight: 6.9 kg (ash veneer)
7.3 kg (with upholstery)

MATERIALS & CONSTRUCTION

Backrest/seat: Painted ash veneer
Upholstered seat: Birch veneer upholstered with fabric or leather
Frame: Black powder coated steel
Glides: Plastic or felt glide
FSC™ Mix-certified wood

CARE

Please see Care & Maintenance guide on www.fermliving.com

PACKSIZE

1

TEST

EN 16139:2013

Furniture - Strength, durability, stability and safety
Requirements for non-domestic seating

Foam fire rating:

CAL117-2013 - pass
BS 5852 Crib5 - pass

STOCK VERSION



9404
Black

CUSTOMISATION OPTIONS

BACKREST & SEAT OPTIONS



Black

FRAME COLOUR



Black

LEATHER QUALITIES (SEAT ONLY)



Leather
Solid



Leather
Envy

NEW

FABRIC QUALITIES (SEAT ONLY)



Cotton
Linen



Brushed



Bouclé



Tonus
4



Steelcut
Trio 3



Hallingdal
65



Fiord
2



Pasadena



Cyber

NEW

To see the specifications of each fabric and available colour assortment please go to overview on page 20
Felt Gliders must be ordered separately against price supplement

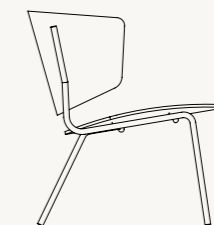

D: 60 cm / 23.6 in

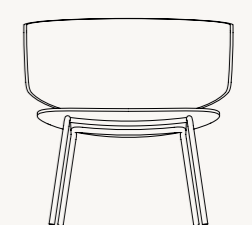

W: 68 cm / 26.8 in



Herman 2-Seater in Ash Veneer with Black frame — Upholstery: Cotton Linen Natural

HERMAN 2-SEATER

In collaboration with Herman Studio

PRODUCT DETAILS

Manufactured in Latvia.
Registered design

DIMENSIONS

Height: 73.4 cm / 28.9 in
Width: 122 cm / 48 in
Depth: 56.5 cm / 22.2 in
Seat height: 38.5 cm / 15.2 in
Weight: 11.3 kg (ash veneer)
12 kg (with upholstery)

MATERIALS & CONSTRUCTION

Backrest/seat: Painted ash veneer
Upholstered seat: Birch veneer upholstered with fabric or leather
Frame: Black powder coated steel
Glides: Plastic or felt glide
FSC™ Mix-certified wood

CARE

Please see Care & Maintenance guide on www.fermliving.com

PACKSIZE

1

TEST

Foam fire rating:
CAL117-2013 - pass
BS 5852 Crib5 - pass

STOCK VERSION



1104263818
Black

CUSTOMISATION OPTIONS

BACKREST & SEAT OPTIONS



Black

FRAME COLOUR



Black

LEATHER QUALITIES (SEAT ONLY)



Leather
Solid



Leather
Envy

NEW

FABRIC QUALITIES (SEAT ONLY)



Cotton
Linen



Brushed



Bouclé



Tonus
4



Steelcut
Trio 3



Hallingdal
65



Fiord
2



Pasadena



Cyber

NEW

To see the specifications of each fabric and available colour assortment please go to overview on page 20
Felt Gliders must be ordered separately against price supplement

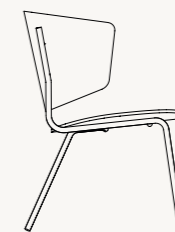

D: 56.5 cm / 22.2 in

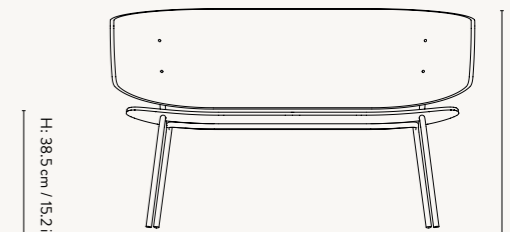

H: 38.5 cm / 15.2 in

W: 122 cm / 48 in

H: 73.4 cm / 28.9 in



Herman Lounge Chair - Wooden Frame - Fabric: Bouclé - Off-white

HERMAN LOUNGE CHAIR - UPHOLSTERED

In collaboration with Herman Studio

PRODUCT DETAILS

Manufactured in Latvia
Registered design

DIMENSIONS

Height: 71 cm / 28 in
Width: 73.5 cm / 28.9 in
Depth: 73.5 cm / 28.9 in
Seat height: 43 cm / 16.9 in
Weight: 6.9 kg (ash veneer)
7.3 kg (with upholstery)

MATERIALS & CONSTRUCTION

Backrest/seat: Birch veneer upholstered with fabric or leather
Frame: Natural solid oak or painted solid ash
Glides: Plastic or felt glides
FSC™ Mix-certified wood

CARE

Please see Care & Maintenance guide on www.fermliving.com

PACKSIZE

1

TEST

EN 16139:2013
Furniture - Strength, durability, stability and safety
Requirements for non-domestic seating

STOCK VERSIONS

NEW



1104265573
Natural Oak



1104265806
Black

CUSTOMISATION OPTIONS

FRAME OPTION

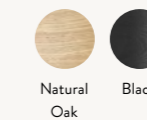

Natural Oak Black

LEATHER QUALITIES



Leather Solid Leather Envy

FABRIC QUALITIES



Cotton Linen Brushed Bouclé Tonus 4 Steelcut Trio 3

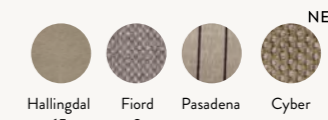

Hallingdal 65 Fiord 2 Pasadena Cyber

To see the specifications of each fabric and available colour assortment please go to overview on page 20
Felt Gliders must be ordered separately against price supplement



W: 73.5 cm / 28.9 in



W: 73.5 cm / 28.9 in

H: 43 cm / 16.9 in

H: 71 cm / 28 in

FABRIC & LEATHER OPTIONS

HERMAN COLLECTION

Price Group 1

| | |
|--------------|---|
| Cotton Linen | • |
| Brushed | • |

Price Group 2

| | |
|--------------|---|
| Faded Velvet | |
| Hot Madison | |
| Cyber | • |

Price Group 3

| | |
|-----------------|---|
| Bouclé | • |
| Leather - Solid | • |
| Pasadena | • |
| Louisiana | |
| Focus | |

Price Group 4

| | |
|-----------------|---|
| Confetti Bouclé | |
| Wool Bouclé | |
| Tonus 4 | • |
| Steelcut Trio 3 | • |
| Rich Linen | |

Price Group 5

| | |
|---------------|---|
| Hallingdal 65 | • |
| Fiord 2 | • |

Price Group 6

| | |
|----------------|---|
| Leather - Envy | • |
|----------------|---|

FABRIC OPTIONS

Price Group 1

BRUSHED



Composition: 100% polyester
Martindale: 90.000
Lightfastness: 5 (5)
Pilling: 5 (5)
Sustainability: Free of heavy metals
Fire rating: CAL 117: pass with treatment
 Crib 5: pass with treatment
 EN 1021 1/2: pass with treatment
Suitable for: Rico Collection
 Herman Collection
 Turn Collection

ferm LIVING colour selection:

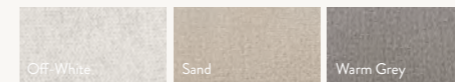

COTTON LINEN



Composition: 60% cotton
 40% linen
Martindale: 24.000
Lightfastness: 4 (8)
Pilling: 4-5 (5)
Fire rating: CAL 117: not pass
 Crib 5: pass with treatment
 EN 1021 1/2: pass with treatment
Suitable for: Catena Collection
 Herman Collection
 Turn Collection

Price Group 2

CYBER

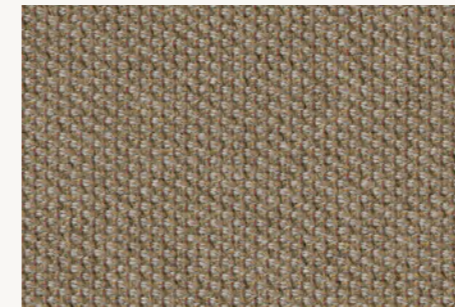

Composition: 100% post-consumer recycled polyester
Martindale: 120.000
Lightfastness: 7-8 (8)
Pilling: 4-5
Sustainability: STANDARD 100 by OEKO-TEX®
 EU Ecolabel
Supplier: Gabriel
Fire rating: CAL117: pass
 Crib 5: pass with treatment
 EN 1021 1/2: pass
Suitable for: Herman Collection
 Turn Collection

ferm LIVING colour selection:

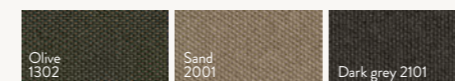

See more colour options at gabriel.com

FABRIC & LEATHER OPTIONS

Price Group 3

BOUCLÉ

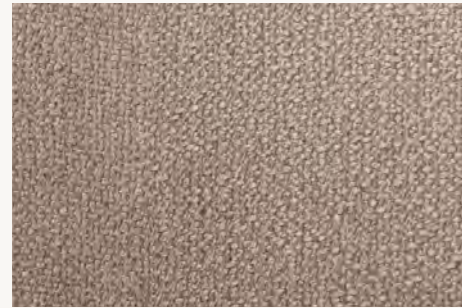

Composition: 35% acrylic, 24% polyester
19% viscose, 14% cotton
5% linen, 3% other fibers
Martindale: 30.000
Lightfastness: 4-5 (8)
Pilling: 4 (5)
Fire rating: CAL 117: pass
Crib 5: pass with treatment
EN 1021 1/2: pass
Suitable for: Rico Collection
Herman Collection
Turn Collection

ferm LIVING colour selection:

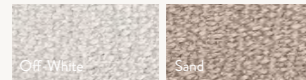

LEATHER - SOLID



Composition: 100% protected and embossed Buffalo leather
Lightfastness: 5 (8)
Pilling: N/A
Supplier: Sørensen Leather
Fire rating: CAL 117: pass
Crib 5: not pass
EN 1021 1/2: pass
Suitable for: Herman Collection

ferm LIVING colour selection:

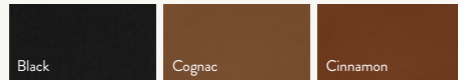

See more colour options at sorensenleather.dk

PASADENA



Composition: 34% linen, 27% viscose, 17% polyester,
12% cotton, 8% wool, 2% acrylic
Martindale: 30.000
Lightfastness: 5 (8)
Pilling: 4 (5)
Fire rating: CAL 117: pass
Crib 5: pass with treatment
EN 1021 1/2: pass with treatment
Suitable for: Catena Collection
Herman Collection
Turn Collection

Price Group 4

TONUS 4

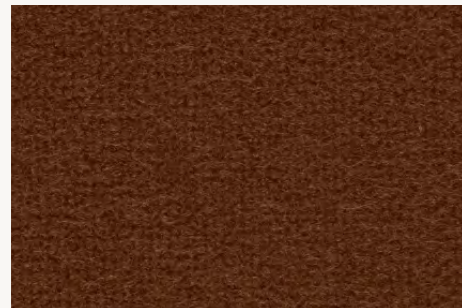

Composition: 90% new wool
10% helanca
Martindale: 100.000
Lightfastness: 5-7 (8)
Pilling: 3 (5)
Supplier: Kvadrat
Sustainability: EU Ecolabel
Greenguard Gold
Fire rating: CAL 117: pass
Crib 5: pass with treatment
EN 1021 1/2: pass
Suitable for: Rico Collection
Herman Collection
Turn Collection

ferm LIVING colour selection:

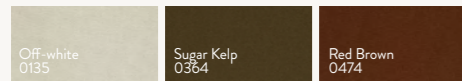

See more colour options at kvadrat.dk

STEELCUT TRIO 3



Composition: 90% new wool
10% nylon
Martindale: 100.000
Lightfastness: 5-7 (8)
Pilling: 3-4 (5)
Supplier: Kvadrat
Sustainability: EU Ecolabel
Greenguard Gold
Fire rating: CAL 117: pass
Crib 5: pass with treatment
EN 1021 1/2: pass
Suitable for: Herman Collection
Turn Collection

ferm LIVING colour selection:

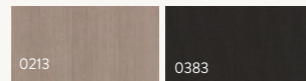

See more colour options at kvadrat.dk

FABRIC OPTIONS

Price Group 5

HALLINGDAL 65

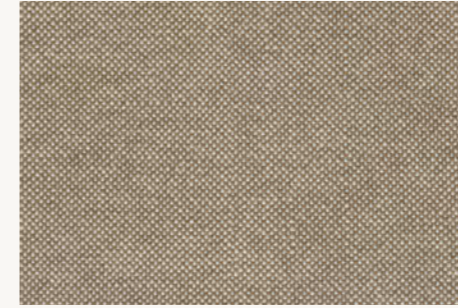

Composition: 70% new wool
30% viscose
Martindale: 100.000
Lightfastness: 5-7 (8)
Pilling: 3-4 (5)
Supplier: Kvadrat
Sustainability: EU Ecolabel
Greenguard Gold
Fire rating: CAL 117: pass
Crib 5: pass
EN 1021 1/2: pass
Suitable for: Catena Collection
Rico Collection
Herman Collection
Turn Collection

ferm LIVING colour selection:

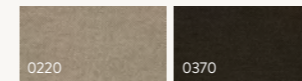

See more colour options at kvadrat.dk

FIORD 2

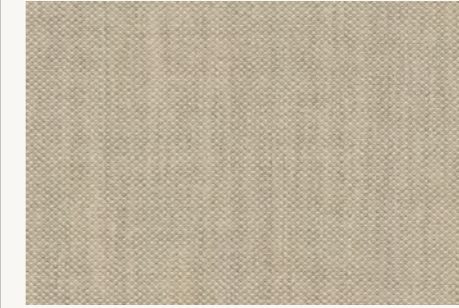

Composition: 92% wool
8% nylon
Martindale: 60.000
Lightfastness: 6 (8)
Pilling: 4-5 (5)
Supplier: Kvadrat
Sustainability: EU Ecolabel
Greenguard Gold
Fire rating: CAL 117: pass
Crib 5: pass with treatment
EN 1021 1/2: pass
Suitable for: Herman Collection
Turn Collection

ferm LIVING colour selection:

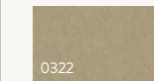

See more colour options at kvadrat.dk

Price Group 6

LEATHER - ENVY

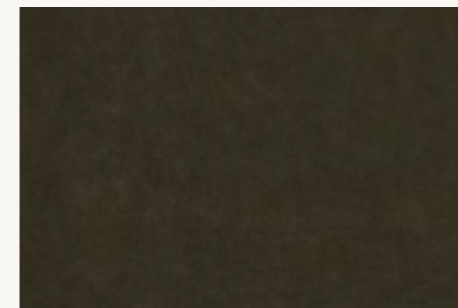

Composition: 100% aniline leather
Lightfastness: 3 (8)
Pilling: N/A
Supplier: Sørensen Leather
Fire rating: CAL117: pass
Crib 5: not pass
EN 1021 1/2: pass
Suitable for: Herman Collection

ferm LIVING colour selection:

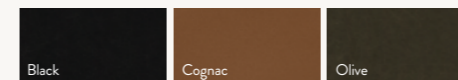

See more colour options at sorensenleather.dk



Life is full of contrasts

As we navigate expectations and dreams in the search for meaning and comfort, we long for a balanced life with room for chaos and calm, moments of reflection and times of joy. A place where we can be ourselves, realise the true value of things and feel at home.

Based on a passion for authentic design and clear functionality, we challenge ourselves to shape the future and take pride in creating products that help you balance the contrasts of life.

Our soft forms, rich textures and deep colours allow you to create an authentic and composed atmosphere, while avant-garde shapes, striking patterns and curious details add a touch of the unexpected.

From our base in Copenhagen, we work with artisans around the world, fusing our Scandinavian mindset with global skills and traditions. We take our responsibility to people and the planet seriously and expect the same of our partners.

We create collections of furniture, accessories and lighting, so you can create space to feel comfortably you.

Welcome home.

