

INSTALLATION GUIDE, 240V

# Orb Mini Pendant Light



**FRAGILE FINISHES**

PLEASE WEAR GLOVES DURING INSTALL







## INSTALLATION GUIDE

# Attention!

Please carefully read instructions before use

PRODUCT:	Orb Mini Pendant 240V
PRODUCT CODE:	MARZ-ORB-MINI-P
RATED VOLTAGE:	220-240VAC
FREQUENCY:	50 HZ
FITTING:	1 lamp 2.5W LED
LAMP TYPE:	G9

### **DANGER: Lights must be installed by a qualified electrician. Electric shock risk.**

- Turn off electrical power before beginning installation and use caution when installing.
- Please do not modify or adjust any fixture in a way that is not clearly stated or intended.
- Always ensure the power is off and the luminaire has cooled down before performing any maintenance to the fitting.
- To avoid injury or damage to the luminaire, ensure that power leads and screws are secure before connecting the power.
- Select a suitable location away from liquids and hazards.
- Ensure that the luminaire does not come in contact with corrosive chemicals/solvents or abrasive cleaners etc.
- To avoid electric shock, do not touch this item if your hands are wet.
- To clean, wipe with a soft damp cloth. Do not soak or immerse the luminaire in water or other liquids.
- Do not use if any breakage or distortion is found on the wiring or socket, or if the products have been wet.
- Marz Designs is not responsible for any damages caused by not following the provided instructions.

### **This luminaire is intended for mounting to a ceiling:**

- Carefully check luminaire and wiring for damage before use. Do not use the fixture if it is damaged.
- Ensure that local voltage and frequency match the marking.
- For indoor use only.
- Do not disassemble the structure of the fixture.
- Do not leave children alone with the product.

- If the external flexible cable or cord of this luminaire is damaged, it shall be exclusively replaced by the manufacturer to avoid hazard.
- Please use reliable suspending and fixing devices to avoid danger.
- This is a Class I device and must be connected to a protective grounding.
- Terminal block and connection box is not included.
- Only qualified personnel may install this device. Please observe national installation regulations.

### **Terminal block shall conform to IEC 60998-2-1 or IEC 60998-2-02 and must comply with the following specifications:**

- With screw or screw-less terminal
- Two terminal poles;
  - Rated voltage: 250V
  - Rated connecting capacity: 10 A; 3 x 0.75-1.5mm<sup>2</sup>
- During installation, ensure that the basic insulation of the supply lead does not touch the ceiling cover. Use proper insulation so that the clearance and distance between the live parts and the ceiling cover is more than 6.5mm between the basic insulation of the supply lead and 3.6mm between the ceiling cover.
- Keep the terminal block inside the ceiling cover or fixed to the ceiling.



ASSEMBLY GUIDE, 240V

# Orb Mini, Pendant Light

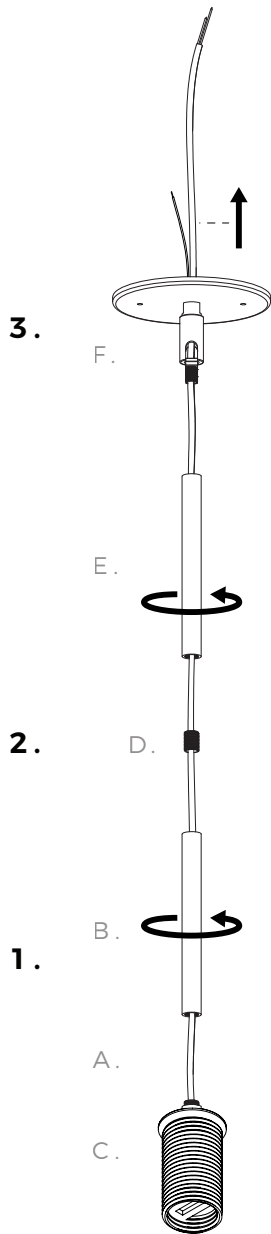

or

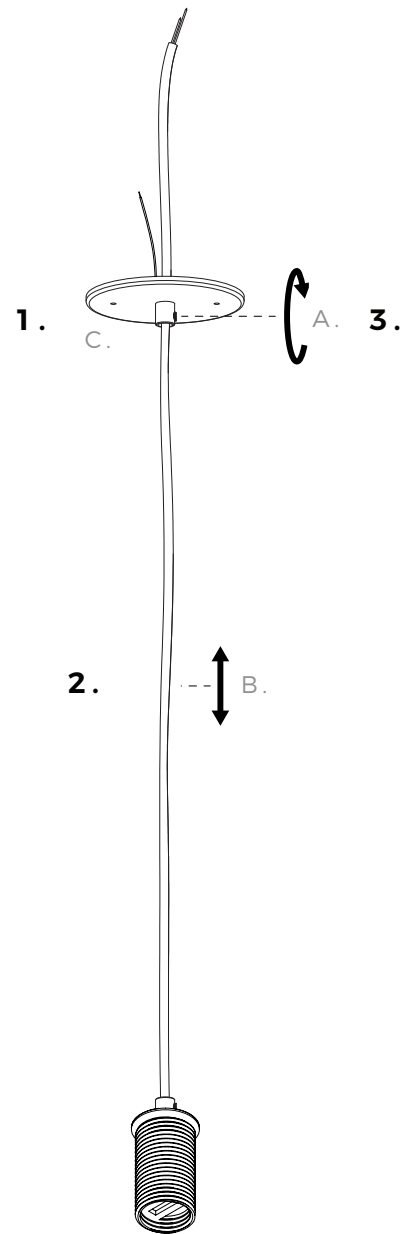

## Assembling the rods

### Pendants with rods

1. Push Cable (A) through Rod (B) and wind Rod (B) onto the base of the Fixture (C).
2. If more than one rod is required, wind Threaded Insert (D) halfway into the Rod (B) leaving enough thread for the next Rod (E) to attach to. Repeat this step for additional lengths.
3. Push the Cable (A) through the Canopy (F) then wind the Canopy (F) onto the last Rod (E) to complete the connection.

### Pendants with fabric flex

1. Undo black plastic Screw (A) on the cable grip.
2. Push Cable (B) through Canopy (C) to suit desired height of pendant.
3. Tighten black plastic Screw (A) on cable grip to secure pendant height in place.



INSTALLATION GUIDE, 240V

# Orb Mini, Pendant Light

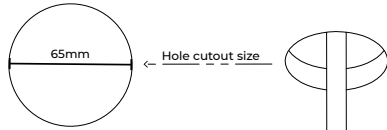

**NOTE**

Make wire connections.  
**For 240V** attach NEUTRAL wire from fixed installation to the black cable marked with "N". Attach LIVE wire from fixed installation to the white cable marked with "L". Attach EARTHING wire from fixed installation to the yellow/green cable.

2.

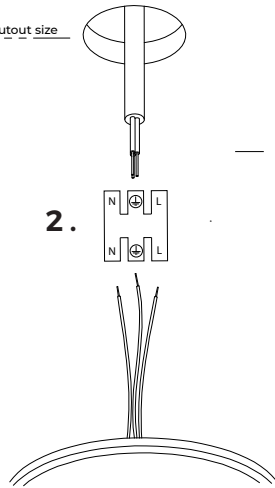

1.

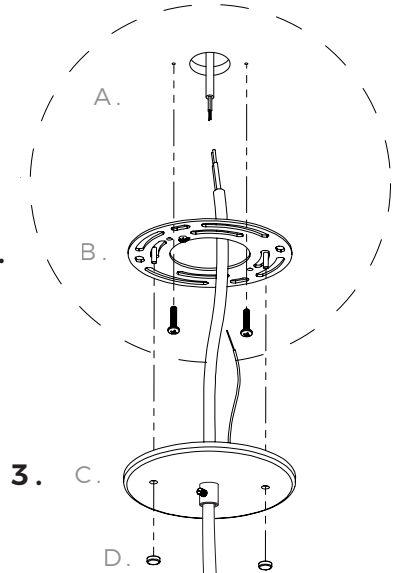

3.

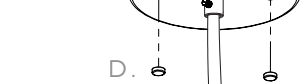

4. E.



5. F.



6. G.

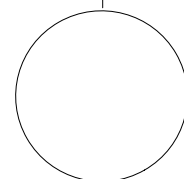

## Mounting and electrical

1. Drill 65mm hole in Ceiling (A) using holesaw to allow for cable termination. Use Anchors (not provided) to fix the Universal Mounting Plate (B) to Ceiling (A).
2. Connect electrical leads from the Ceiling to the leads from the Fixture. Ensure the wires are secure and no bare wires are exposed, using an enclosed junction box.
3. Install the Canopy (C) on the Ceiling over the Universal Mounting Plate (B) and secure in place with screw head Caps (D) supplied.
4. Push the Light Globe (E) into the Fixture Socket.
5. Slide Sleeve (F) over Fixture and hold in place.
6. Screw the Glass Cover (G) onto the Fixture Socket, screw until there is contact with Sleeve (F). CAUTION: Align threads properly for a smooth rotation before twisting to avoid jamming. Do not over-tighten the globe.