

SPRINTER 144 SUBFLOOR

Installation Guide

www.sergsupply.com

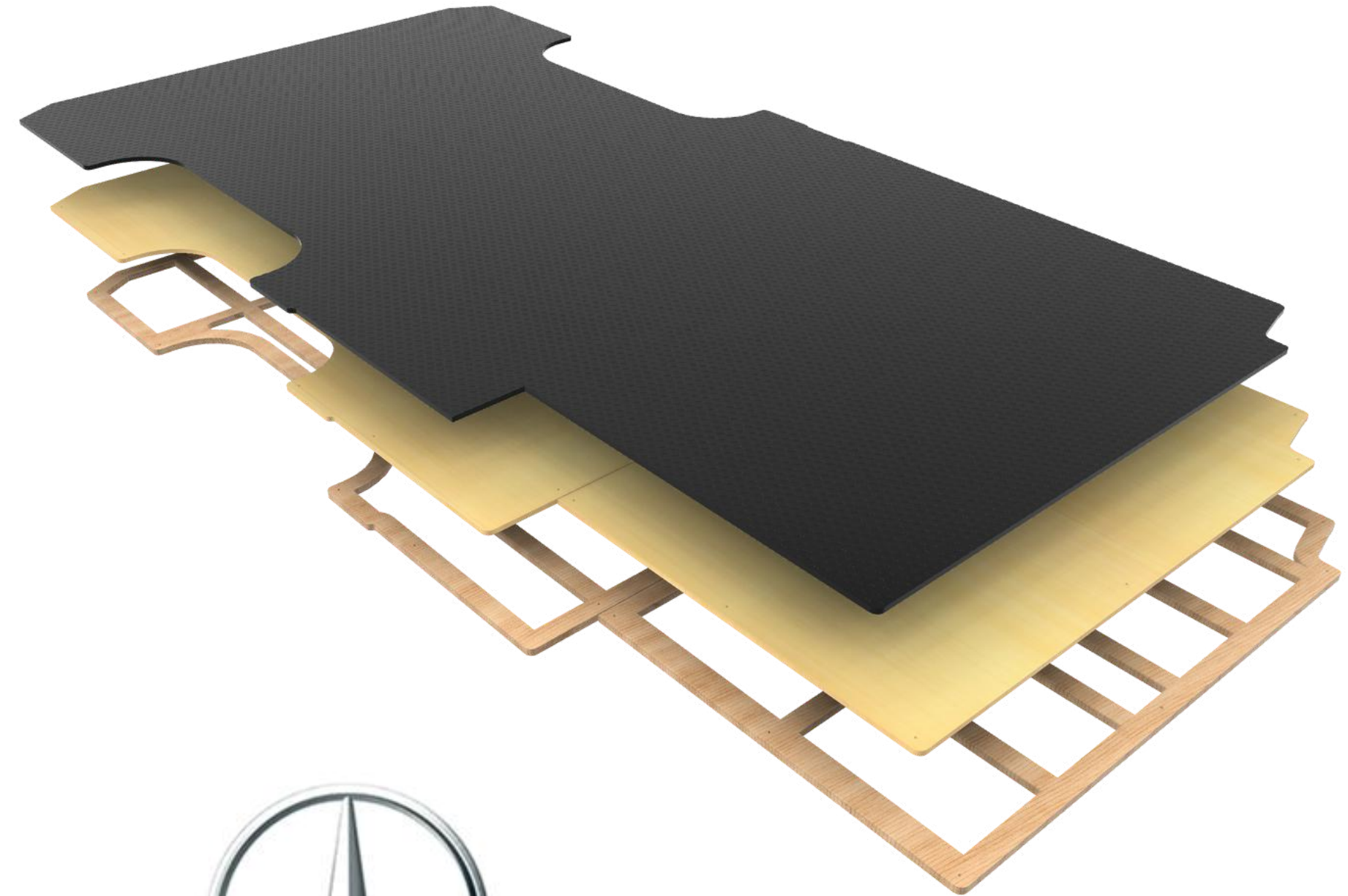

What you will need to get started:

- 

Epoxy
Lonseal or similar
- 

Construction Adhesive
With caulking gun
- 

Level
Larger is Better
- 

A Helping Hand
Buy them lunch!

 **Disclaimer!** 

This flooring kit must be adhered properly to the floor of the vehicle to avoid damage or injury. Modification to this floor may affect the structural strength of the product. Avoid making large cuts on vehicle partitions or beams as this may weaken the vehicle. You are responsible for ensuring proper wiring and insulation when wiring your build as faulty wiring may create a fire hazard. Any cabinetry or load-bearing components need to be mounted to the vehicle and not to the floor alone. Any holes made in the vehicle floor must be properly coated to prevent corrosion.

What's Included:

Your flooring kit will include:

- Insulation frame
- Subfloor
- Lonseal Floor

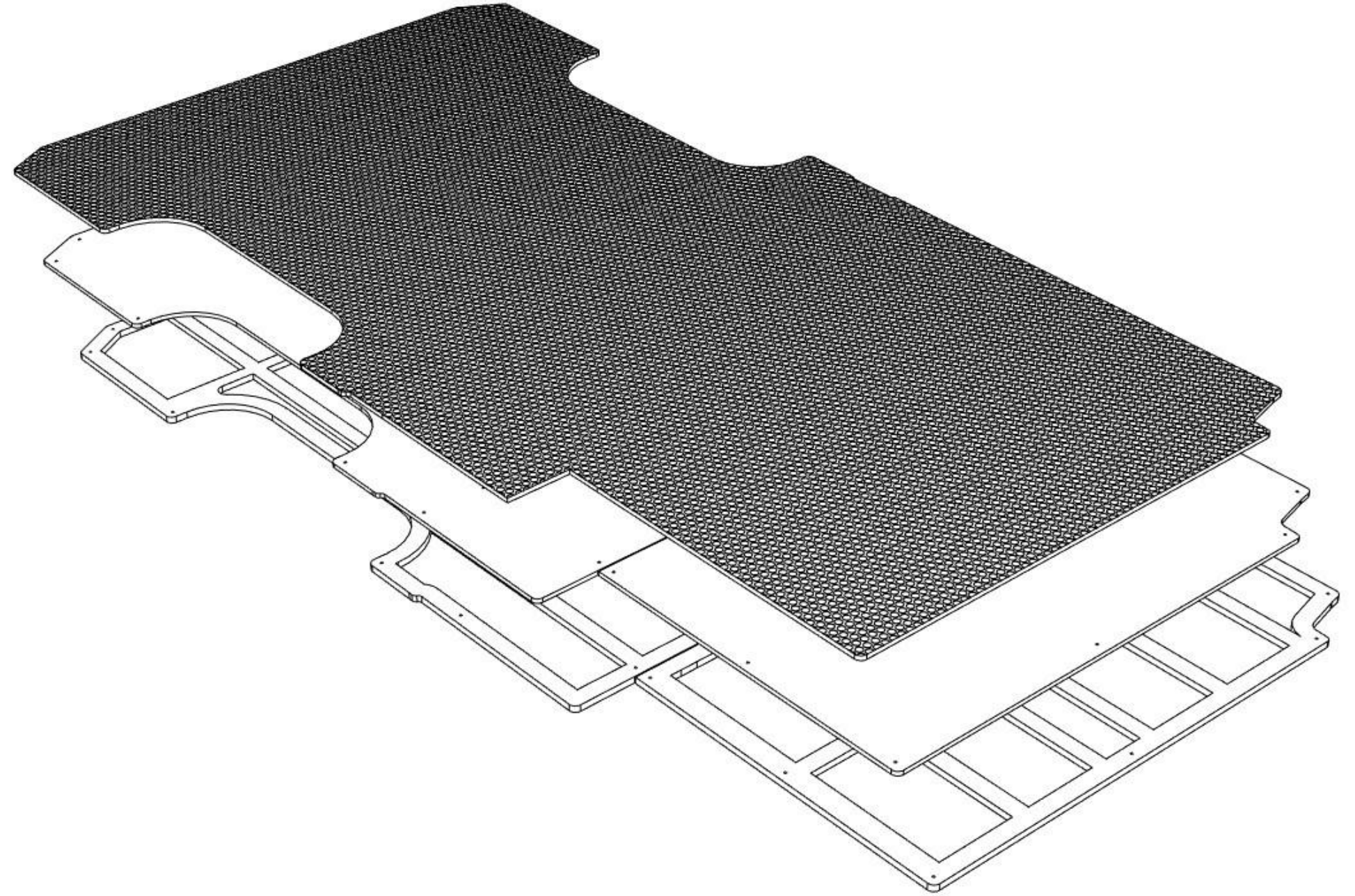

Pre-Installation Tips

1. Get a helping hand. This installation is dramatically easier with someone to help you out and offer good company.
2. It is greatly helpful to park your vehicle on a leveled surface. This floor works best when installed level.
3. Make sure the top surface of the floor is cleaned with no dirt or debris on the surface.
4. It is greatly helpful to make a thorough roughing using 120-200 grit sandpaper the top surface of the floor ribs, to which the floor adjoins.

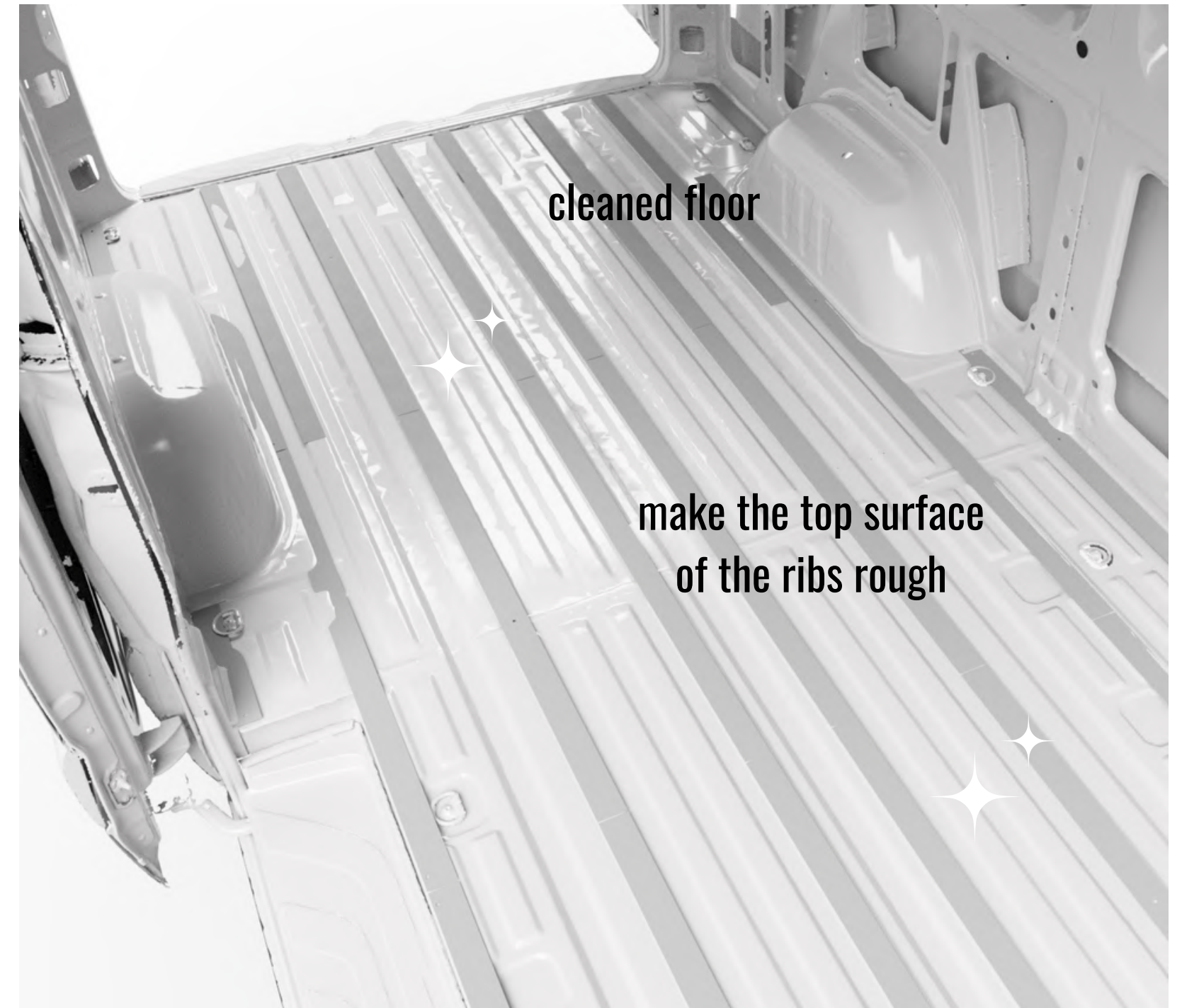

If You Are Installing a Step Extension

1. For a **Serg Supply** step extension, you'll need a power drill with a Phillips head.
2. Insert the step extension and align it such that the front face is flush with the overlapping metal edge on your sprinter.
3. Use your power drill to shoot the step into the left face using the two pre-drilled holes on the left end bracket.
4. Set the step to hold a 90-degree edge and shoot the included self-tappers into vehicle using the predrilled holes on the right side of your step.



Insulation Frame Installation

1. Lay down a heavy bead of construction adhesive onto the section of the ribs Behind the wheel well.
2. Lay down your first panel (rearmost panel) and align such that there is even spacing on all sides and put your level on top of the panel. Adjust the edges until it's perfectly level from left to right and front to back.

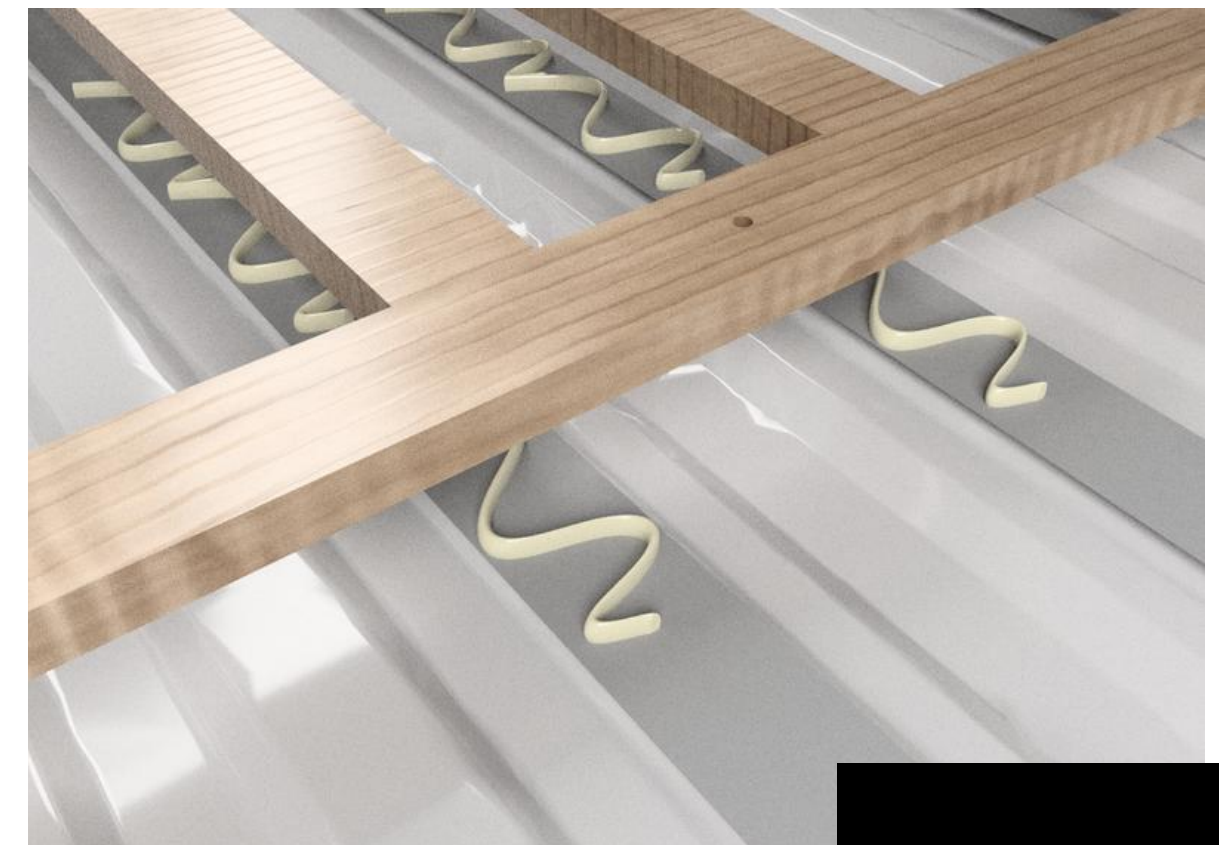

Insulation Frame Installation

3. Apply construction adhesive to the next 45" of floor and lay down your second panel and place the 1/8" shims between the panels. Just as with the first panel, align the spacing between the outside edges for a centered placement.
4. Level this panel while also making sure the panel height matches the first panel.
5. Continue to repeat the shimming and leveling process for the next panel.
6. Let the construction adhesive cure for the recommended length of time before applying any weight to the subfloor.

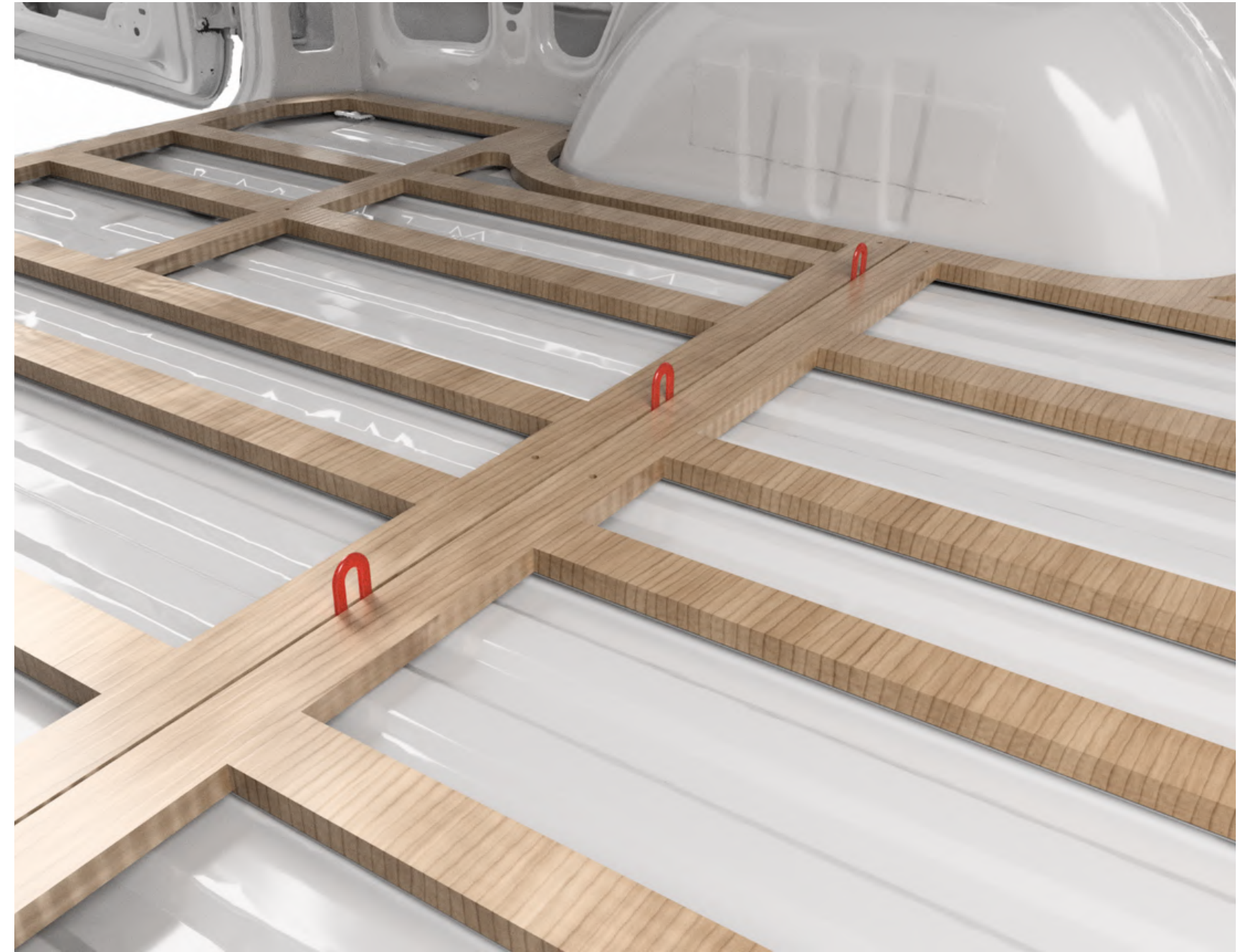

Note: The shims are specifically designed to accommodate the expansion and contraction of the subfloor panels. These panels should not be contacting one another during installation.

Insulation

- Insulation is recommended, but not absolutely required.
- Before laying insulation in the compartments, clear any debris. It helps to spray adhesive in these space prior to installing the insulation.

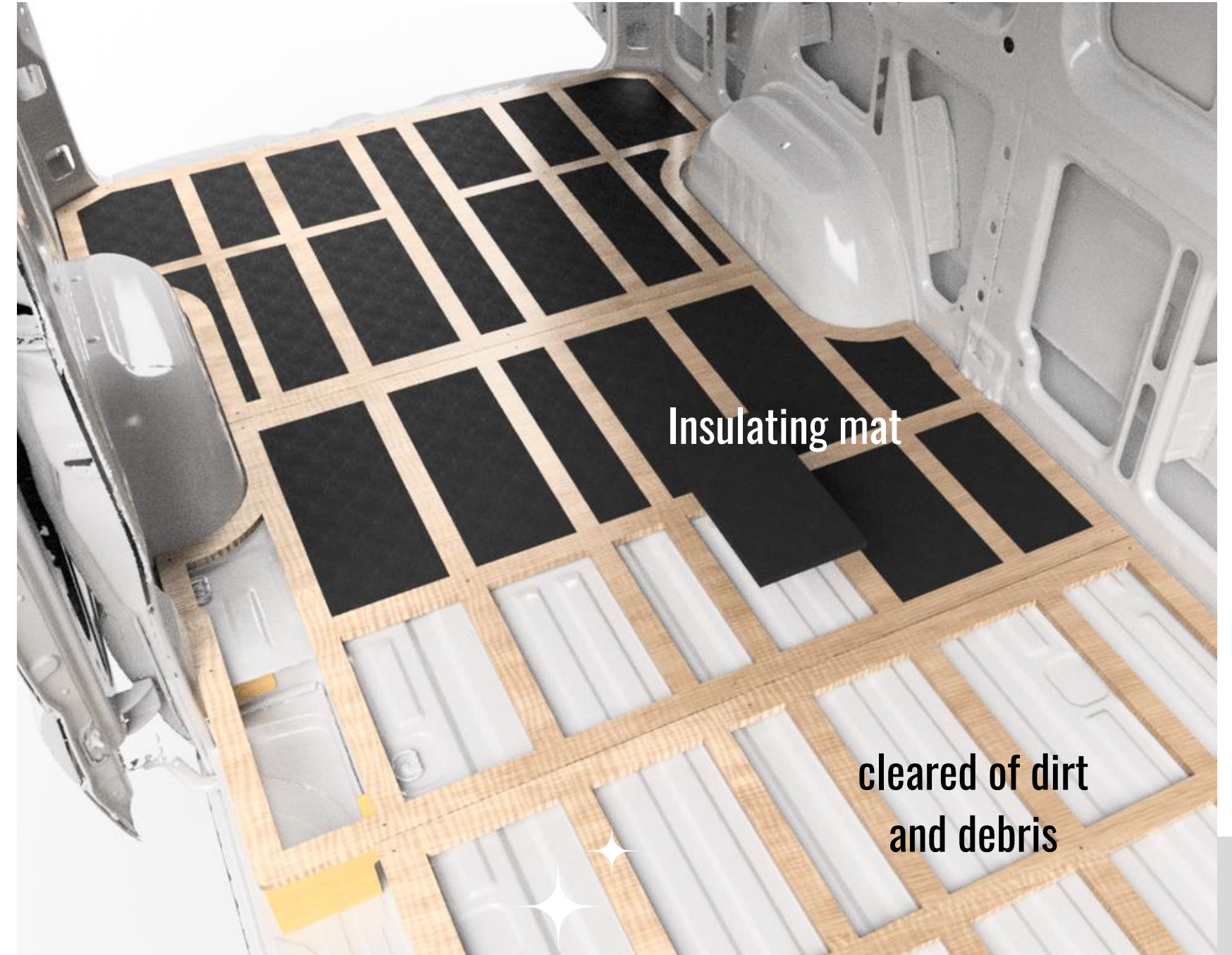

Sub-Floor Installation

1. Lay down a heavy bead of construction adhesive.
2. Lay down your first panel (rearmost panel) and align such that there is even spacing on all sides and put your level on top of the panel. Adjust the edges until it's perfectly level from left to right and front to back.
3. Align the center of the subfloor panel with the center of the insulation frame. With the outer edges flush, you can drive in the center screw with a power drill. The insulation frame and subfloor are pre-drilled to match up seamlessly with countersunk holes.

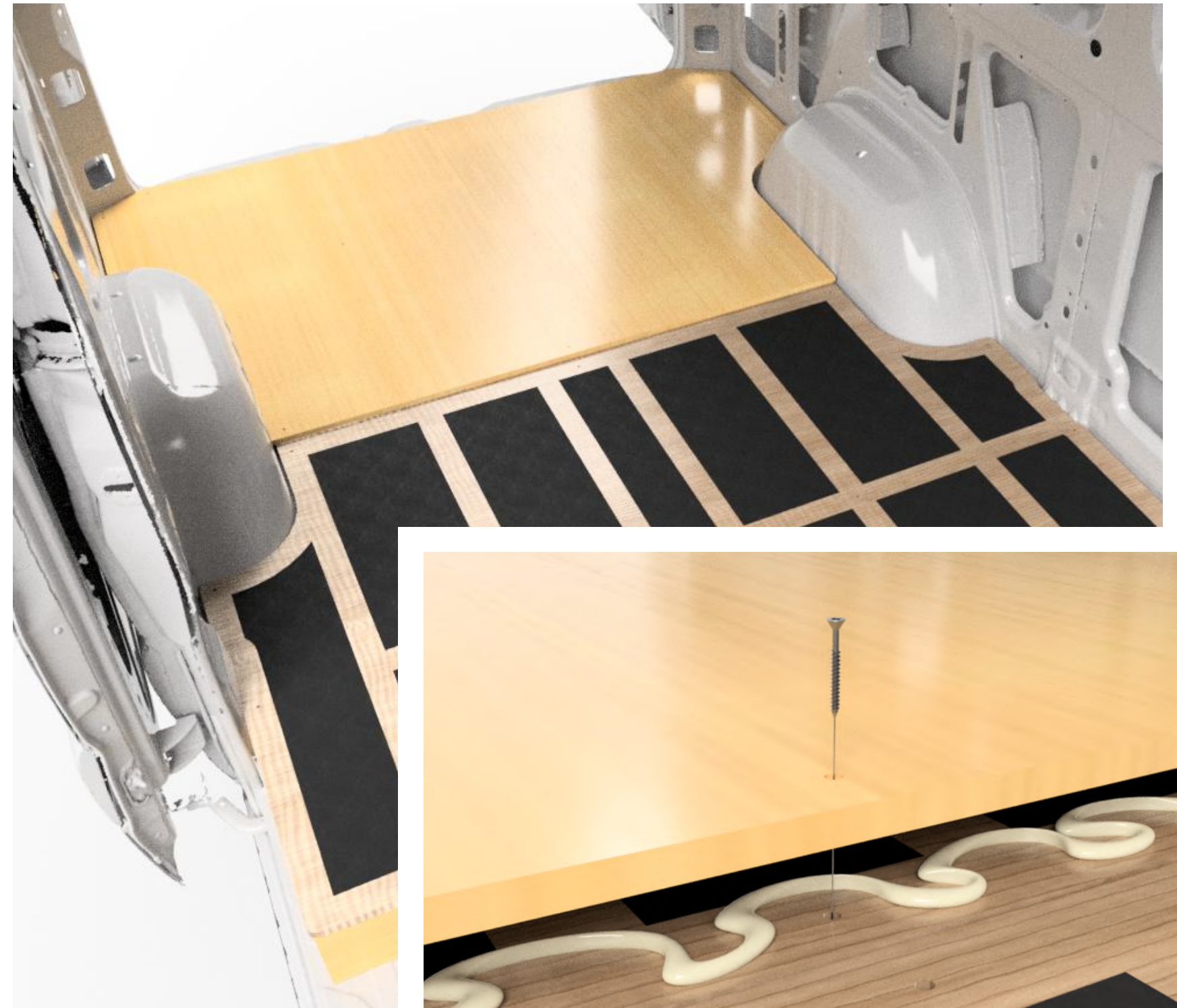

Sub-Floor Installation

4. Insert your shims between each row for perfect spacing before continuing.
5. Align the outer edges and drive the screws in place.
6. Work your way from the center outwards in both directions until all screws are shot in before removing the shims.

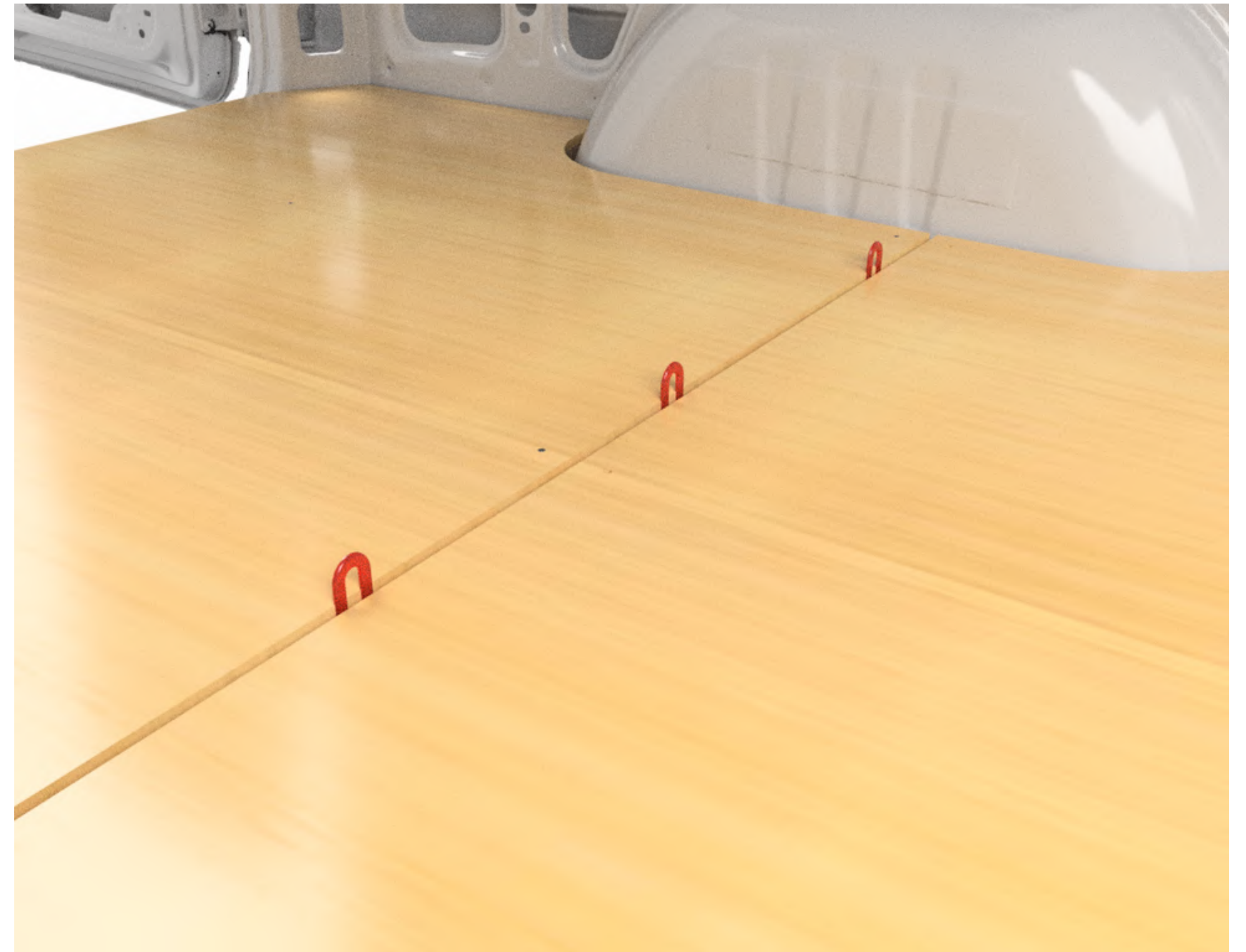

Note: The shims are specifically designed to accommodate the expansion and contraction of the subfloor panels. These panels should not be contacting one another during installation.

Sub-Floor Installation

7. Let the construction adhesive cure for the recommended length of time before applying any weight to the subfloor.
8. There is approximately 3/8" of space between the outside edge of the subfloor to the factory wall in most places. This space is intended to be sealed with caulking/silicone to provide a long-lasting waterproof seal. This should also be applied in the 1/8" gaps between the floor panels.



Lonseal Floor Installation

1. Make sure the top surface of the subfloor is cleaned with no dirt or debris on the surface.
2. This process is easier when begun from the rear of the vehicle. Keep your lonseal rolled up and apply a coat of lonseal epoxy or similar adhesive to the first foot of your floor.

NOTE: The widest points of the van are in front of and behind the wheel wells. You can always use these spaces as resting points.

3. Apply the first foot of your lonseal floor to the subfloor. We cut our lonseal for perfect alignment, so just match up the edges.

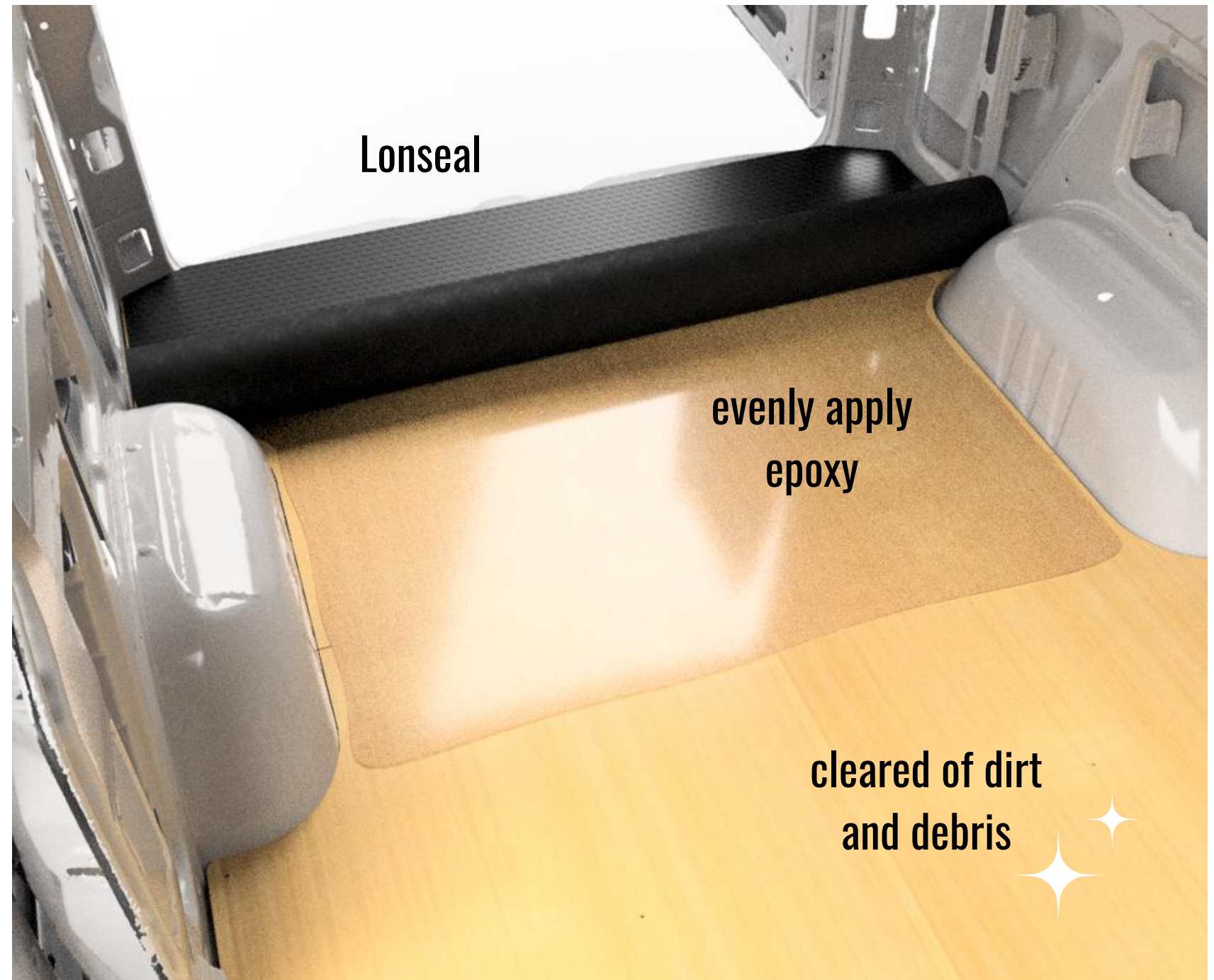

Lonseal Floor Installation

4. As you move towards the front of the vehicle, use a hand brush to clean any debris off the subfloor as you move.
5. Evenly apply epoxy and unroll the lonseal as you work towards the front of the van.
6. Use a heavy duty roller to roll out any air bubbles as you lay the roll out.
7. Once cured, go back and lay another edge of silicone/caulking to seal the edges.

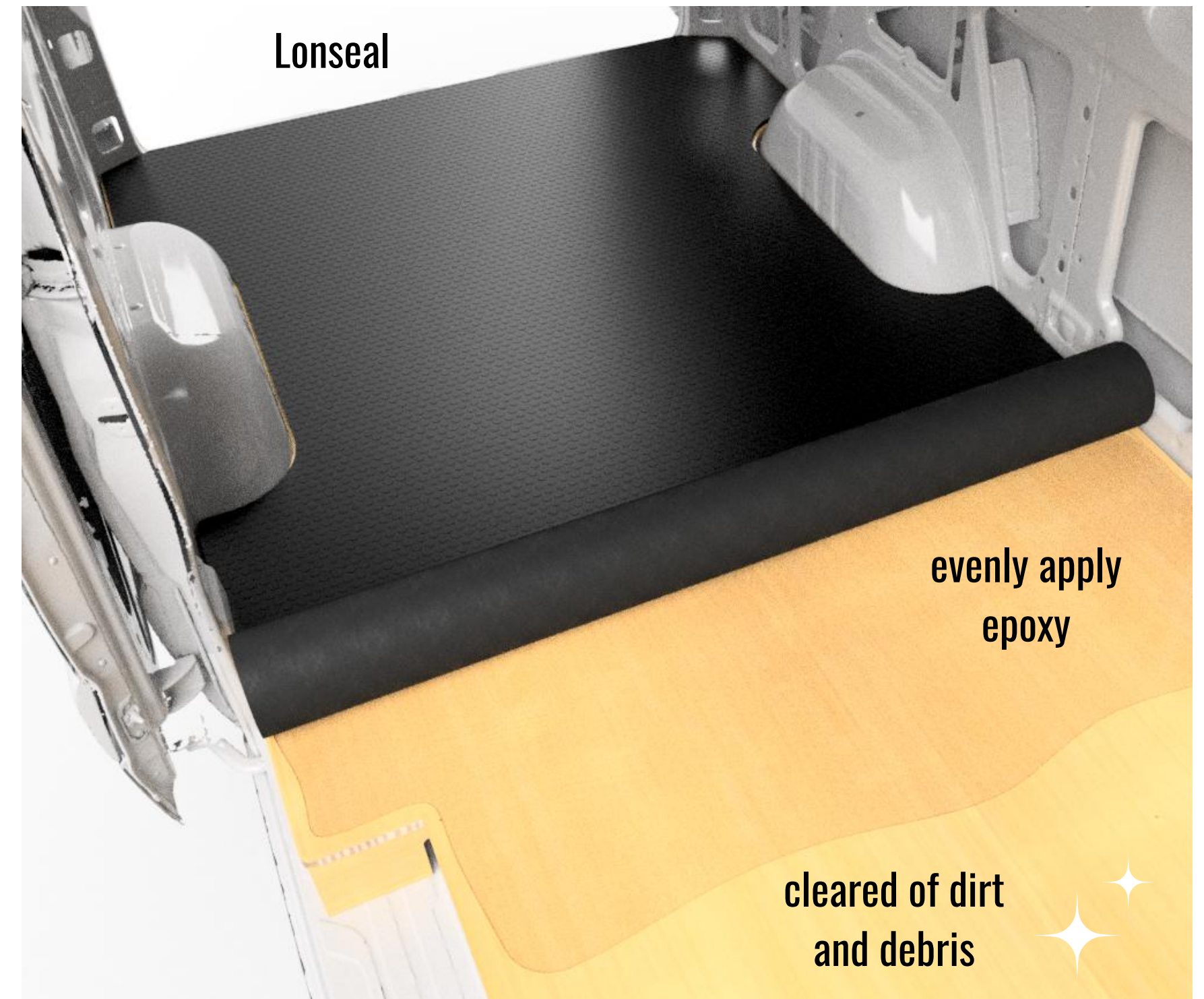

Lonseal Floor Installation

8. Loncoin/Lonwood floor is cut to 1/2" wider than the sub floor to close unsightly gaps and corners. This will require minor trimming in several places
9. If desired, install front/rear trim slider door trim to cover the edges.

