

RADIO TEST REPORT

For

Quanshun Communication Technology Co., Ltd

DMR Digital Portable Radio

Test Model: D5X

Prepared for : Quanshun Communication Technology Co., Ltd
Address : Quanshun Bldg., Daxiamei, Nan'an, Quanzhou, Fujian, China
362302

Prepared by : Shenzhen LCS Compliance Testing Laboratory Ltd.
Address : 1/F., Xingyuan Industrial Park, Tongda Road, Bao'an Avenue,
Bao'an District, Shenzhen, Guangdong, China

Tel : (+86)755-82591330
Fax : (+86)755-82591332
Web : www.LCS-cert.com
Mail : webmaster@LCS-cert.com

Date of receipt of test sample : May 15, 2016
Number of tested samples : 1
Serial number : D5X
Date of Test : May 15, 2016 ~ June 11, 2016
Date of Report : June 25, 2016

**RADIO TEST REPORT
FCC Part 90**

Report Reference No. : **LCS1412030188E**

Date of Issue : June 25, 2016

Testing Laboratory Name : **Shenzhen LCS Compliance Testing Laboratory Ltd.**

Address : 1/F., Xingyuan Industrial Park, Tongda Road, Bao'an Avenue,
Bao'an District, Shenzhen, Guangdong, China

Testing Location/ Procedure : Full application of Harmonised standards
Partial application of Harmonised standards
Other standard testing method

Applicant's Name..... : **Quanshun Communication Technology Co., Ltd**

Address : Quanshun Bldg., Daxiamei, Nan'an, Quanzhou, Fujian, China
362302

Test Specification

Standard : FCC Part 90/FCC Part 2/FCC Part 15B

Test Report Form No. : LCSEMC-1.0

TRF Originator : Shenzhen LCS Compliance Testing Laboratory Ltd.

Master TRF : Dated 2011-03

Shenzhen LCS Compliance Testing Laboratory Ltd. All rights reserved.

This publication may be reproduced in whole or in part for non-commercial purposes as long as the Shenzhen LCS Compliance Testing Laboratory Ltd. is acknowledged as copyright owner and source of the material. Shenzhen LCS Compliance Testing Laboratory Ltd. takes no responsibility for and will not assume liability for damages resulting from the reader's interpretation of the reproduced material due to its placement and context.

Test Item Description. : **DMR Digital Portable Radio**

Trade Mark..... : Talkpod

Test Model : D5X

Ratings : DC 7.4V by Lithium ion polymer battery(1650mAh)
Recharge Voltage: DC 8.4V/400mA

Result : **Positive**

Compiled by:

Aking Jin

Aking Jin/ File administrators

Supervised by:

Glin Lu

Glin Lu/ Technique principal

Approved by:

Gavin Liang

Gavin Liang/ Manager

RADIO -- TEST REPORT

Test Report No. : LCS1412030188E	<u>June 25, 2016</u> Date of issue
---	---------------------------------------

Test Model.....	: D5X
EUT.....	: DMR Digital Portable Radio
Applicant.....	: Quanshun Communication Technology Co., Ltd
Address.....	: Quanshun Bldg., Daxiamei, Nan'an, Quanzhou, Fujian, China 362302
Telephone.....	: /
Fax.....	: /
Manufacturer.....	: Quanshun Communication Technology Co., Ltd
Address.....	: Quanshun Bldg., Daxiamei, Nan'an, Quanzhou, Fujian, China 362302
Telephone.....	: /
Fax.....	: /
Factory.....	: Quanshun Communication Technology Co., Ltd
Address.....	: Quanshun Bldg., Daxiamei, Nan'an, Quanzhou, Fujian, China 362302
Telephone.....	: /
Fax.....	: /

Test Result	Positive
--------------------	-----------------

The test report merely corresponds to the test sample.
 It is not permitted to copy extracts of these test result without the written permission of the test laboratory.

Revision History

Revision	Issue Date	Revisions	Revised By
00	2016-06-08	Initial Issue	Gavin Liang
01	2016-08-04	Add description of Radiated spurious emission	Gavin Liang

TABLE OF CONTENTS

1. GENERAL INFORMATION	6
1.1. PRODUCT DESCRIPTION FOR EQUIPMENT UNDER TEST (EUT)	6
1.2. OBJECTIVE	6
1.3. RELATED SUBMITTAL(S)/GRANT(S).....	6
1.4. DESCRIPTION OF TEST FACILITY	7
1.5. SUPPORT EQUIPMENT LIST	7
1.6. EXTERNAL I/O	7
1.7. MEASUREMENT UNCERTAINTY.....	7
1.8. TEST ENVIRONMENT	7
1.9. DESCRIPTION OF TEST MODES	7
2. SYSTEM TEST CONFIGURATION	9
2.1. JUSTIFICATION	9
2.2. EUT EXERCISE SOFTWARE	9
2.3. SPECIAL ACCESSORIES.....	9
2.4. BLOCK DIAGRAM/SCHEMATICS	9
2.5. EQUIPMENT MODIFICATIONS	9
2.6. CONFIGURATION OF TEST SETUP	9
3. SUMMARY OF TEST RESULT.....	10
4. TEST CONDITIONS AND RESULTS.....	11
4.1. CONDUCTED EMISSIONS TEST.....	11
4.2. OCCUPIED BANDWIDTH AND EMISSION MASK TEST.....	15
4.3. TRANSMITTER RADIATED SPURIOUS EMISSION	23
4.4. SPURIOUS EMISSION ON ANTENNA PORT	28
4.5. MODULATION CHARACTERISTICS	42
4.6. FREQUENCY STABILITY TEST.....	45
4.7. MAXIMUM TRANSMITTER POWER.....	47
4.8. TRANSMITTER FREQUENCY BEHAVIOR	54
5. LIST OF MEASURING EQUIPMENT.....	57

1. GENERAL INFORMATION

1.1. Product Description for Equipment Under Test (EUT)

EUT	: DMR Digital Portable Radio
Test Model	: D5X
Power Supply	: DC 7.4V by Lithium ion polymer battery(1650mAh) Recharged by DC 8.4V/400mA
Hardware Version	: TP-D5X UHF-V1.X
Software Version	: TP-D5X V1.00
Frequency Range	: 400MHz-470MHz
Channel Separation	: Analog Voice 12.5KHz Digital Voice/Data 12.5KHz Digital Data 12.5KHz
Modulation Type	: FM for Analog Voice 4FSK for Digital Voice/Digital Data 4FSK for Digital Data
Emission Designator	: 11K0F3E for FM Modulation at 12.5KHz Channel Separation 7K60FXD for Digital Data only at 12.5KHz Channel Separation 7K60FXW for Digital Data & Digital Voice at 12.5KHz Channel Separation
Antenna Description	: External, 0dBi (Max)
Rated Power	: 4Watts/1Watts

Note: The product has the same digital working characters when operating in both two digitized voice/data mode. So only one set of test results for digital modulation modes are provided in this test report.

1.2. Objective

The tests were performed according to following standards:

[FCC Rules Part 90: 2015](#): PRIVATE LAND MOBILE RADIO SERVICES.

[47 CFR FCC Part 15 Subpart B: 2015](#) - Unintentional Radiators

[FCC Part 2](#): FREQUENCY ALLOCATIONS AND RADIO TREATY MATTERS; GENERAL RULES AND REGULATIONS

[TIA/EIA 603 D: June 2014](#): Land Mobile FM or PM Communications Equipment Measurement and Performance Standards.

1.3. Related Submittal(s)/Grant(s)

No Related Submittals.

1.4. Description of Test Facility

CNAS Registration Number. is L4595.

FCC Registration Number. is 899208.

Industry Canada Registration Number. is 9642A-1.

VCCI Registration Number. is C-4260 and R-3804.

ESMD Registration Number. is ARCB0108.

UL Registration Number. is 100571-492.

TUV SUD Registration Number. is SCN1081.

TUV RH Registration Number. is UA 50296516-001

1.5. Support equipment List

Manufacturer	Description	Model	Serial Number	Certificate
Quanshun Communication Technology Co., Ltd	Adapter	BC-50A	--	CE
Quanshun Communication Technology Co., Ltd	Charger	BC-50D	--	CE

1.6. External I/O

I/O Port Description	Quantity	Cable
Microphone Jack	1	N/A
Earphone Jack	1	N/A
Battery Pole Piece	1	N/A

1.7. Measurement Uncertainty

Where relevant, the following measurement uncertainty levels have been estimated for tests performed on the apparatus:

Test Items	Measurement Uncertainty	Notes
Frequency stability	30 Hz	(1)
Transmitter power conducted	0.62 dB	(1)
Transmitter power Radiated	2.67 dB	(1)
Conducted spurious emission 9KHz-40 GHz	1.88 dB	(1)
Conducted Emission 9KHz-30MHz	1.63 dB	(1)
Radiated Emission 30~1000MHz	4.65 dB	(1)
Radiated Emission 1~18GHz	3.89 dB	(1)
Radiated Emission 18-40GHz	3.90 dB	(1)
Occupied Bandwidth	-----	(1)
Emission Mask	-----	(1)
Modulation Characteristic	-----	(1)
Transmitter Frequency Behavior	-----	(1)

(1) This uncertainty represents an expanded uncertainty expressed at approximately the 95% confidence level using a coverage factor of $k=1.96$.

1.8. Test Environment

Items	Required (IEC 68-1)	Actual
Temperature (°C)	15-35	21
Humidity (%RH)	25-75	50
Barometric pressure (mbar)	860-1060	950-1000

1.9. Description Of Test Modes

The EUT has been tested under typical operating condition and The Transmitter was operated in the normal operating mode. The TX frequency was fixed which was for the purpose of the measurements.

EUT operation mode no.	Description of operation mode	Additional information
Op 1	FM+BW12.5KHz+TX	The equipment is set with FM modulation and 12.5KHz bandwidth at maximum rated power for transmitter, powered by DC 7.40V
Op 2	FM+BW12.5KHz+TX	The equipment is set with FM modulation and 12.5KHz bandwidth at minimum rated power for transmitter, powered by DC 7.40V
Op 3	4FSK+BW12.5KHz+TX	The equipment is set with 4FSK modulation and 12.5KHz bandwidth at maximum rated power for transmitter, powered by DC 7.40V
Op 4	4FSK+BW12.5KHz+TX	The equipment is set with 4FSK modulation and 12.5KHz bandwidth at minimum rated power for transmitter, powered by DC 7.40V
Op 5	FM+BW12.5KHz+RX (Standby)	The equipment is set with FM modulation and 12.5KHz bandwidth at Receiver/Standby mode, powered by DC 7.40V(or for charging mode for AC conducted emission)
Op 6	4FSK+BW12.5KHz+RX (Standby)	The equipment is set with 4FSK modulation and 12.5KHz bandwidth at Receiver/Standby mode, powered by DC 7.40V(or for charging mode for AC conducted emission)

Test frequency list

Modulation Type	Channel Separation	Test Channel	Test Frequency (MHz)	
			TX	RX
Analog/FM	12.5KHz	Ch1	406.125	406.125
		Ch2	456.125	456.125
		Ch3	469.975	469.975
Digital/4FSK	12.5KHz	Ch4	406.125	406.125
		Ch5	456.125	456.125
		Ch6	469.975	469.975

2. SYSTEM TEST CONFIGURATION

2.1. Justification

The system was configured for testing in engineering mode.

2.2. EUT Exercise Software

N/A.

2.3. Special Accessories

N/A.

2.4. Block Diagram/Schematics

Please refer to the related document.

2.5. Equipment Modifications

Shenzhen LCS Compliance Testing Laboratory Ltd. has not done any modification on the EUT.

2.6. Configuration of Test Setup

Please refer to the test setup photo.

3. SUMMARY OF TEST RESULT

Test specification clause	Test case	Verdict
FCC Part 15.107	Conducted Emission	PASS
FCC Part 90.205	Maximum Transmitter Power	PASS
FCC Part 90.207	Modulation Characteristic	PASS
FCC Part 90.209	Occupied Bandwidth	PASS
FCC Part 90.210	Emission Mask	PASS
FCC Part 90.213	Frequency Stability	PASS
FCC Part 90.214	Transmitter Frequency Behavior	PASS
FCC Part 90.210	Transmitter Radiated Spurious Emission	PASS
FCC Part 90.210	Spurious Emission On Antenna Port	PASS

Remark:

- 1. The measurement uncertainty is not included in the test result.*

4. TEST CONDITIONS AND RESULTS

4.1. Conducted Emissions Test

TEST APPLICABLE

The EUT was tested according to ANSI C63.4 - 2014. The frequency spectrum from 0.15 MHz to 30 MHz was investigated. The LISN used was 50 ohm / 50 u Henry as specified by section 5.1 of ANSI C63.4 - 2014. Cables and peripherals were moved to find the maximum emission levels for each frequency.

TEST CONFIGURATION

For AC Power

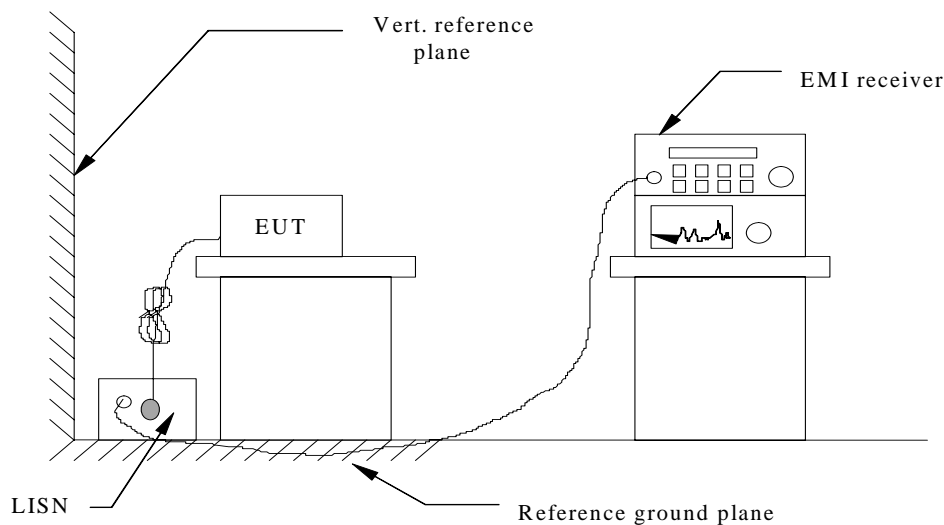

TEST PROCEDURE

- 1 The equipment was set up as per the test configuration to simulate typical actual usage per the user's manual. The EUT is a tabletop system; a wooden table with a height of 0.8 meters is used and is placed on the ground plane as per ANSI C63.4-2014.
- 2 Support equipment, if needed, was placed as per ANSI C63.4-2014.
- 3 All I/O cables were positioned to simulate typical actual usage as per ANSI C63.4-2014.
- 4 If a EUT received AC120V/60Hz power through a Line Impedance Stabilization Network (LISN) which supplied power source and was grounded to the ground plane.
- 5 All support equipments received AC power from a second LISN, if any.
- 6 The EUT test program was started. Emissions were measured on each current carrying line of the EUT using a spectrum Analyzer / Receiver connected to the LISN powering the EUT. The LISN has two monitoring points: Line 1 (Hot Side) and Line 2 (Neutral Side). Two scans were taken: one with Line 1 connected to Analyzer / Receiver and Line 2 connected to a 50 ohm load; the second scan had Line 1 connected to a 50 ohm load and Line 2 connected to the Analyzer / Receiver.
- 7 Analyzer / Receiver scanned from 150 KHz to 30MHz for emissions in each of the test modes.
- 8 During the above scans, the emissions were maximized by cable manipulation.

Conducted Power Line Emission Limit

For intentional device, according to § 15.207(a) and RSS-Gen Section 7.2.4 for AC Power Conducted Emission Limits is as following:

Frequency (MHz)	Maximum RF Line Voltage (dB μ V)			
	CLASS A		CLASS B	
	Q.P.	Ave.	Q.P.	Ave.
0.15 - 0.50	79	66	66-56*	56-46*
0.50 - 5.00	73	60	56	46
5.00 - 30.0	73	60	60	50

* Decreasing linearly with the logarithm of the frequency

TEST RESULTS

Remark:

1. We tested all Op 5 to Op 6, recorded worst case at Op 5. Please Refer to the following page.

Op 5
Test Result for Line Power Input AC 240V/50Hz

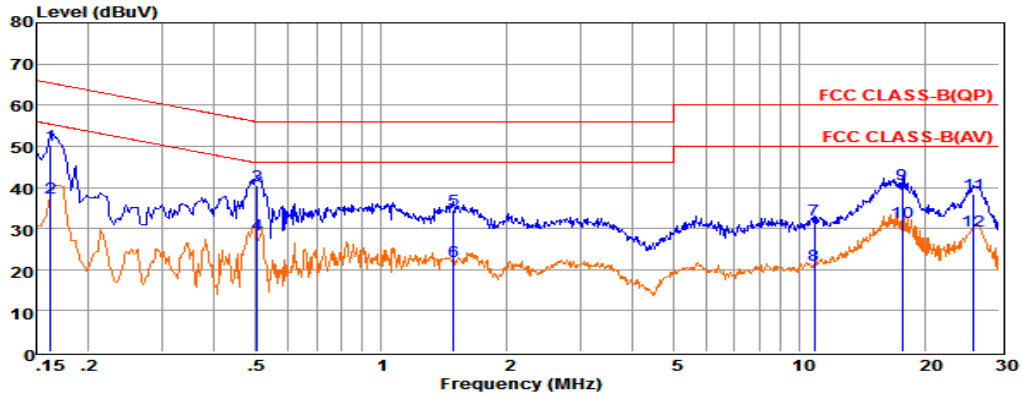

Env. Ins: 24*/56%
 Power Rating: AC 240V/60Hz
 Pol: NEUTRAL

Freq	Reading	LisnFac	CabLos	Atten_Fac	Measured	Limit	Over	Remark
MHz	dBuV	dB	dB	dB	dBuV	dBuV	dB	
1 0.16241	30.51	9.67	0.02	10.00	50.20	65.34	-15.14	QP
2 0.16251	17.91	9.67	0.02	10.00	37.60	55.33	-17.73	Average
3 0.50469	20.83	9.62	0.04	10.00	40.49	56.00	-15.51	QP
4 0.50479	8.90	9.62	0.04	10.00	28.56	46.00	-17.44	Average
5 1.48743	14.94	9.63	0.05	10.00	34.62	56.00	-21.38	QP
6 1.48843	2.30	9.63	0.05	10.00	21.98	46.00	-24.02	Average
7 10.84735	12.18	9.72	0.08	10.00	31.98	60.00	-28.02	QP
8 10.84835	1.41	9.72	0.08	10.00	21.21	50.00	-28.79	Average
9 17.56779	20.80	9.79	0.11	10.00	40.70	60.00	-19.30	QP
10 17.56879	11.70	9.79	0.11	10.00	31.60	50.00	-18.40	Average
11 1126.13933	18.36	9.83	0.13	10.00	38.32	60.00	-21.68	QP
12 1226.14033	9.58	9.83	0.13	10.00	29.54	50.00	-20.46	Average

Remarks: 1. Measured = Reading + Lisn Factor +Cable Loss+Atten_Fac.
 2. The emission levels that are 20dB below the official limit are not reported.

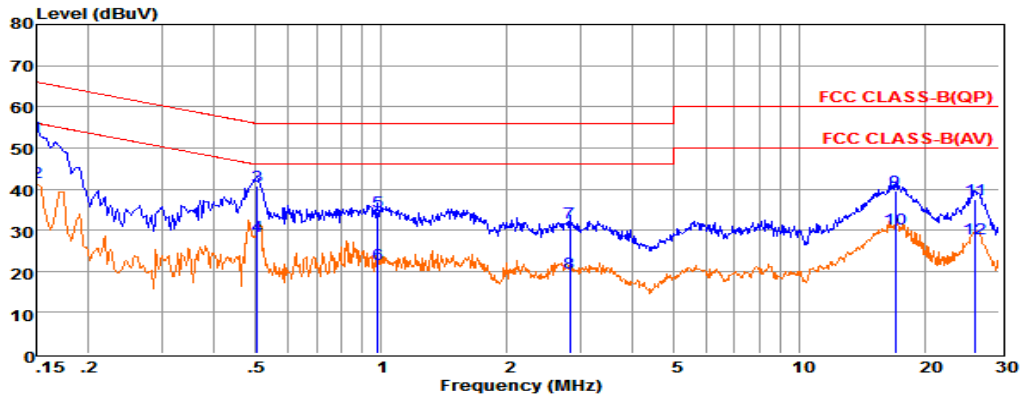

Env. Ins: 24*/56%
 Power Rating: AC 240V/60Hz
 Pol: NEUTRAL

Freq	Reading	LisnFac	CabLos	Atten_Fac	Measured	Limit	Over	Remark
MHz	dBuV	dB	dB	dB	dBuV	dBuV	dB	
1 0.15000	32.93	9.70	0.02	10.00	52.65	66.00	-13.35	QP
2 0.15010	21.81	9.70	0.02	10.00	41.53	55.99	-14.46	Average
3 0.50469	21.14	9.62	0.04	10.00	40.80	56.00	-15.20	QP
4 0.50479	8.97	9.62	0.04	10.00	28.63	46.00	-17.37	Average
5 0.98391	14.87	9.63	0.05	10.00	34.55	56.00	-21.45	QP
6 0.98401	2.11	9.63	0.05	10.00	21.79	46.00	-24.21	Average
7 2.82398	12.01	9.64	0.06	10.00	31.71	56.00	-24.29	QP
8 2.82498	-0.16	9.64	0.06	10.00	19.54	46.00	-26.46	Average
9 16.92817	19.76	9.76	0.11	10.00	39.63	60.00	-20.37	QP
10 16.92917	10.36	9.76	0.11	10.00	30.23	50.00	-19.77	Average
11 1126.27819	17.52	9.83	0.13	10.00	37.48	60.00	-22.52	QP
12 1226.27919	8.11	9.83	0.13	10.00	28.07	50.00	-21.93	Average

Remarks: 1. Measured = Reading + Lisn Factor +Cable Loss+Atten_Fac.
 2. The emission levels that are 20dB below the official limit are not reported.

Test Result for Line Power Input AC 120V/60Hz

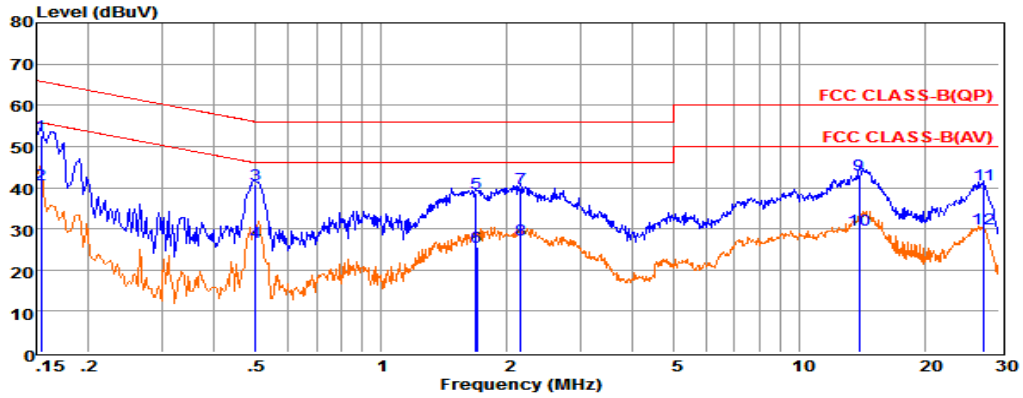

Env. Ins: 24*/56%
 Power Rating: AC 120V/60Hz
 Pol: LINE

	Freq	Reading	LisnFac	CabLos	Atten_Fac	Measured	Limit	Over	Remark
	MHz	dBuV	dB	dB	dB	dBuV	dBuV	dB	
1	0.15403	33.18	9.58	0.02	10.00	52.78	65.78	-13.00	QP
2	0.15413	21.02	9.58	0.02	10.00	40.62	55.77	-15.15	Average
3	0.50203	21.20	9.62	0.04	10.00	40.86	56.00	-15.14	QP
4	0.50213	7.11	9.62	0.04	10.00	26.77	46.00	-19.23	Average
5	1.68913	19.12	9.64	0.05	10.00	38.81	56.00	-17.19	QP
6	1.69013	5.99	9.64	0.05	10.00	25.68	46.00	-20.32	Average
7	2.15531	20.30	9.64	0.05	10.00	39.99	56.00	-16.01	QP
8	2.15631	7.69	9.64	0.05	10.00	27.38	46.00	-18.62	Average
9	913.91464	23.34	9.71	0.10	10.00	43.15	60.00	-16.85	QP
10	1013.91564	10.02	9.71	0.10	10.00	29.83	50.00	-20.17	Average
11	1127.56162	20.90	9.71	0.14	10.00	40.75	60.00	-19.25	QP
12	1227.56262	10.12	9.71	0.14	10.00	29.97	50.00	-20.03	Average

Remarks: 1. Measured = Reading + Lisn Factor +Cable Loss+Atten_Fac.
 2. The emission levels that are 20dB below the official limit are not reported.

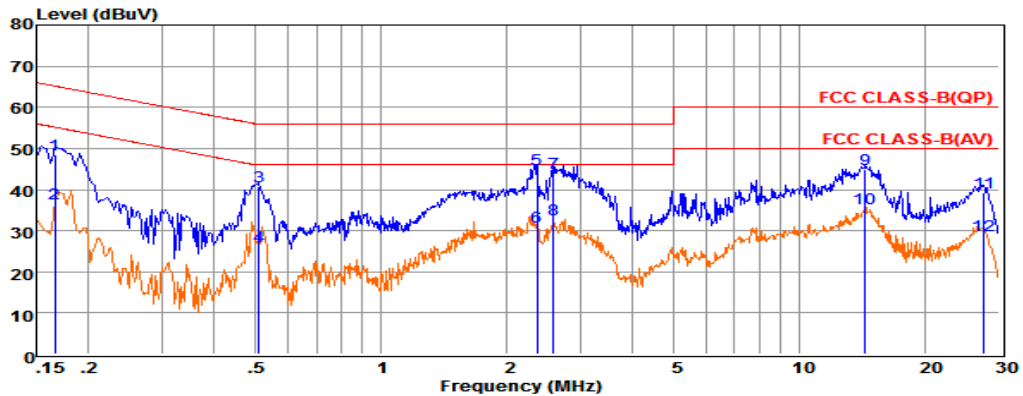

Env. Ins: 24*/56%
 Power Rating: AC 120V/60Hz
 Pol: NEUTRAL

	Freq	Reading	LisnFac	CabLos	Atten_Fac	Measured	Limit	Over	Remark
	MHz	dBuV	dB	dB	dB	dBuV	dBuV	dB	
1	0.16589	28.87	9.66	0.02	10.00	48.55	65.16	-16.61	QP
2	0.16599	16.96	9.66	0.02	10.00	36.64	55.16	-18.52	Average
3	0.51007	21.01	9.62	0.04	10.00	40.67	56.00	-15.33	QP
4	0.51017	6.51	9.62	0.04	10.00	26.17	46.00	-19.83	Average
5	2.35845	25.29	9.64	0.05	10.00	44.98	56.00	-11.02	QP
6	2.35945	11.39	9.64	0.05	10.00	31.08	46.00	-14.92	Average
7	2.58074	24.24	9.64	0.05	10.00	43.93	56.00	-12.07	QP
8	2.58174	12.96	9.64	0.05	10.00	32.65	46.00	-13.35	Average
9	914.36409	25.03	9.74	0.10	10.00	44.87	60.00	-15.13	QP
10	1014.36509	15.50	9.74	0.10	10.00	35.34	50.00	-14.66	Average
11	1127.56162	19.18	9.84	0.14	10.00	39.16	60.00	-20.84	QP
12	1227.56262	8.99	9.84	0.14	10.00	28.97	50.00	-21.03	Average

Remarks: 1. Measured = Reading + Lisn Factor +Cable Loss+Atten_Fac.
 2. The emission levels that are 20dB below the official limit are not reported.

4.2. Occupied Bandwidth and Emission Mask Test

TEST APPLICABLE

- (a). Occupied Bandwidth: The EUT was connected to the audio signal generator and the spectrum analyzer via the main RF connector, and through an appropriate attenuator. The EUT was controlled to transmit its maximum power. Then the bandwidth of 99% power can be measured by the spectrum analyzer.
- (c). Emission Mask D, 12.5 kHz channel bandwidth equipment: For transmitters designed to operate with a 12.5 kHz channel bandwidth, any emission must be attenuated below the power (P) of the highest emission contained within the authorized bandwidth as follows:
- (1) On any frequency from the centre of the authorized bandwidth f_0 to 5.625 kHz removed from f_0 : Zero dB.
 - (2) On any frequency removed from the centre of the authorized bandwidth by a displacement frequency (f_d in kHz) of more than 5.625 kHz but no more than 12.5 kHz: At least $7.27(f_d - 2.88 \text{ kHz})$ dB.
 - (3) On any frequency removed from the centre of the authorized bandwidth by a displacement frequency (f_d in kHz) of more than 12.5 kHz: At least $50 + 10 \log(P)$ dB or 70 dB, whichever is the lesser attenuation.

TEST CONFIGURATION

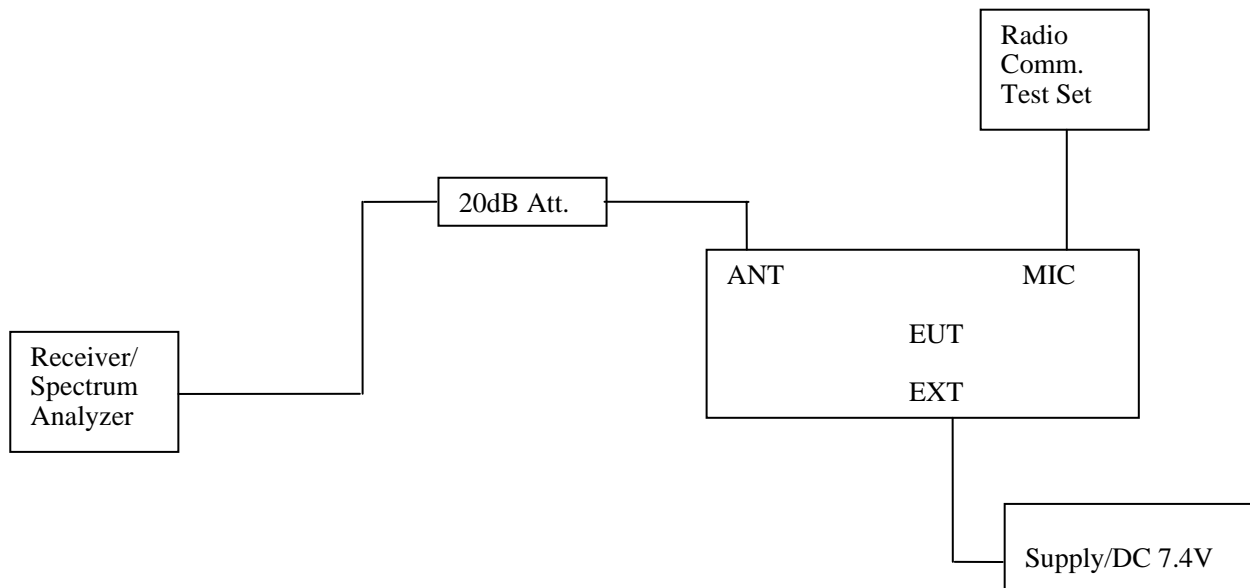

TEST PROCEDURE

- 1 The EUT was placed on a turn table which is 0.8m above ground plane.
- 2 The EUT was modulated by 2.5 KHz Sine wave audio signal; the level of the audio signal employed is 16 dB greater than that necessary to produce 50% of rated system deviation. Rated system deviation is 2.5 kHz (12.5 kHz channel spacing).
- 3 Set EUT as normal operation.
- 4 Set SPA Centre Frequency = fundamental frequency, RBW=300Hz, VBW= 3 KHz, span =50 KHz.
- 5 Set SPA Max hold. Mark peak, Set 99% Occupied Bandwidth and 26dB Occupied Bandwidth.
- 6 Set SPA Centre Frequency=fundamental frequency, set =300Hz, VBW=1 KHz, span=50 KHz for 12.5 KHz channel spacing.

TEST RESULTS

Remark:

1. We tested Op 1 to Op 4, recorded worst case at Op 1 and Op 3.

4.2.1 Occupied Bandwidth

Modulation Type	Channel Separation	Operation Mode	Test Channel	Test Frequency (MHz)	Occupied Bandwidth (KHz)	
					99%	26dB
Analog/FM	12.5KHz	Op 1	Ch1	406.125	6.37	10.42
			Ch2	456.125	6.05	10.35
			Ch3	469.975	6.06	10.35
Digital/4FSK	12.5KHz	Op 3	Ch4	406.125	7.75	9.79
			Ch5	456.125	7.26	8.85
			Ch6	469.975	7.23	9.34
Limit			11.25KHz for 12.5KHz Channel Separation			
Test Results			PASS			

Plots of 99% and 26dB Bandwidth Measurement

Modulation Type	Channel Separation	Operation Mode	Test Channel	Test Frequency (MHz)	Occupied Bandwidth (KHz)		Limit (KHz)	Results
					99%	26dB		
FM	12.5 KHz	Op 1	Ch1	406.125	6.37	10.42	11.25	PASS

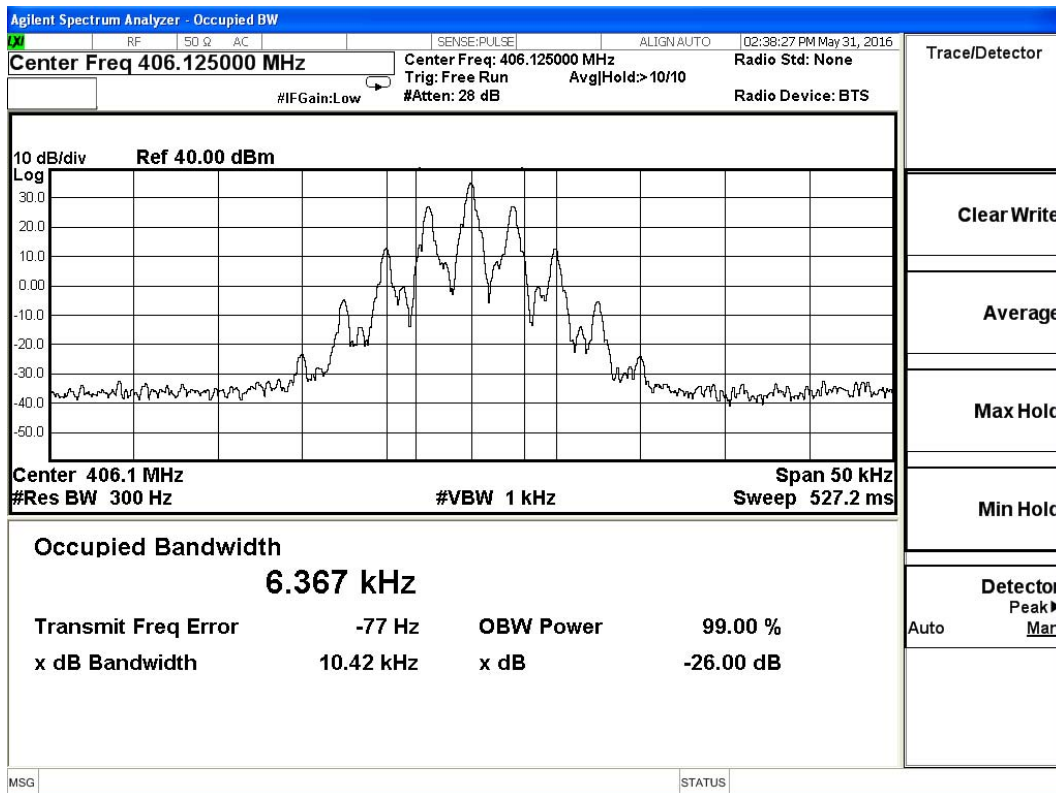

Modulation Type	Channel Separation	Operation Mode	Test Channel	Test Frequency (MHz)	Occupied Bandwidth (KHz)		Limit (KHz)	Results
					99%	26dB		
FM	12.5 KHz	Op 1	Ch2	456.125	6.05	10.35	11.25	PASS

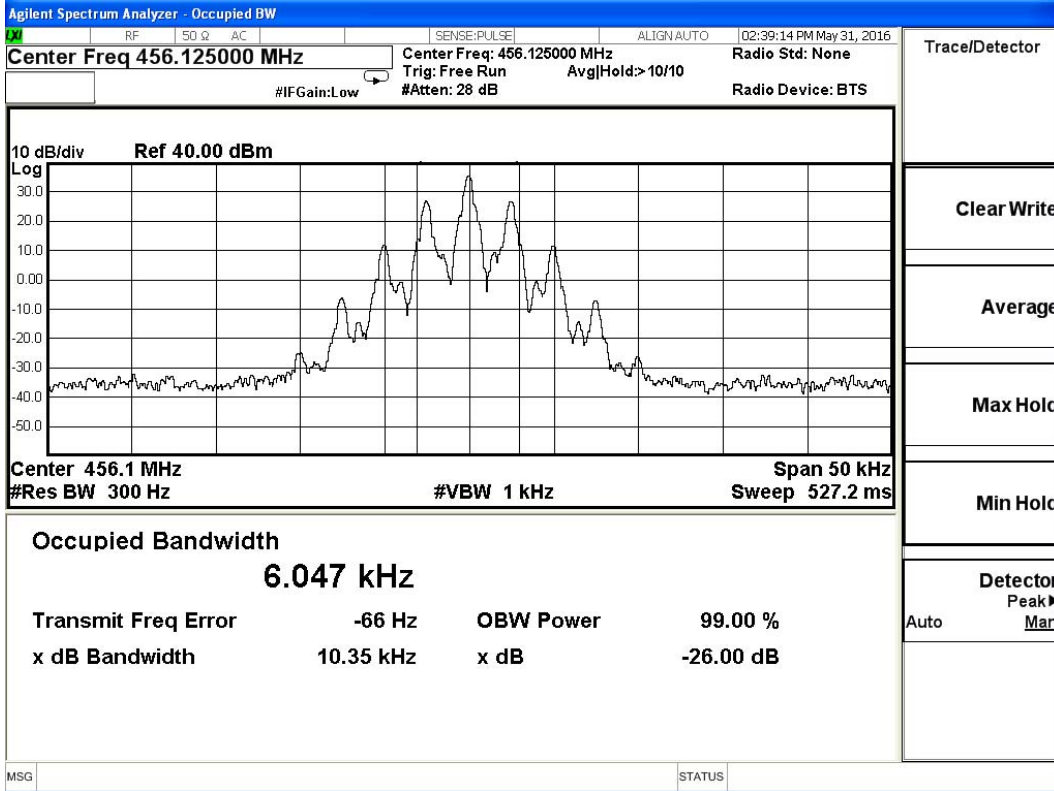

Modulation Type	Channel Separation	Operation Mode	Test Channel	Test Frequency (MHz)	Occupied Bandwidth (KHz)		Limit (KHz)	Results
					99%	26dB		
FM	12.5 KHz	Op 1	Ch3	469.975	6.06	10.35	11.25	PASS

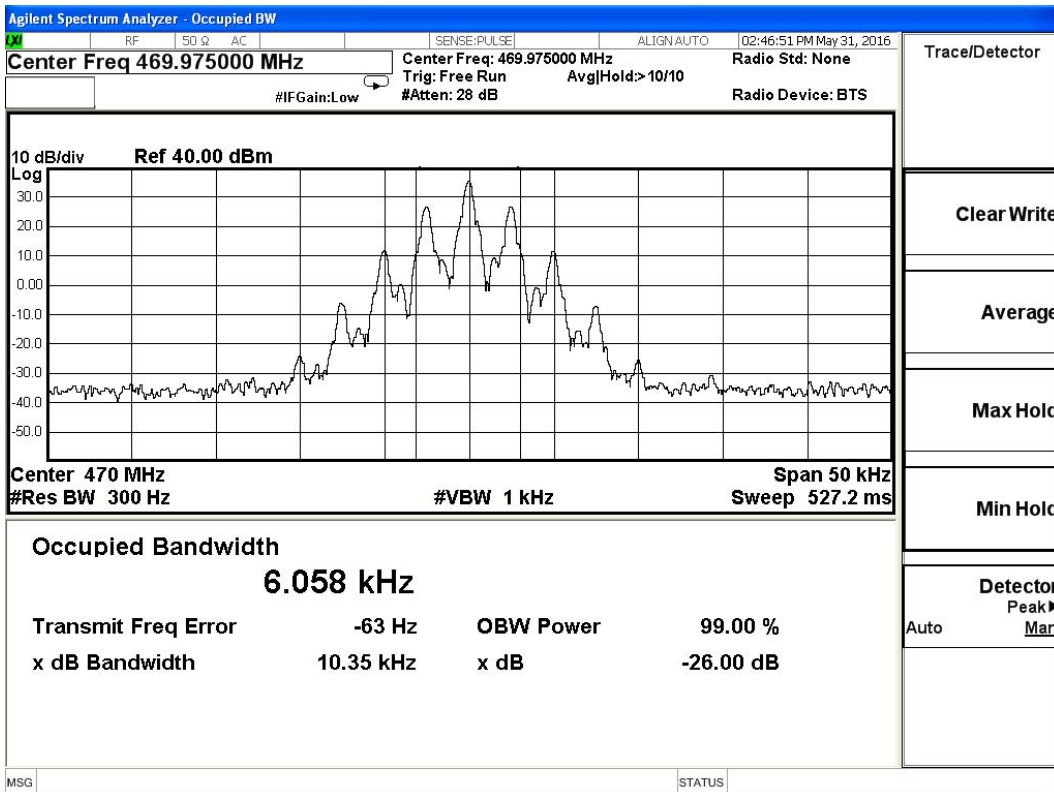

Modulation Type	Channel Separation	Operation Mode	Test Channel	Test Frequency (MHz)	Occupied Bandwidth (KHz)		Limit (KHz)	Results
					99%	26dB		
4FSK	12.5 KHz	Op 3	Ch4	406.125	7.75	9.79	11.25	PASS

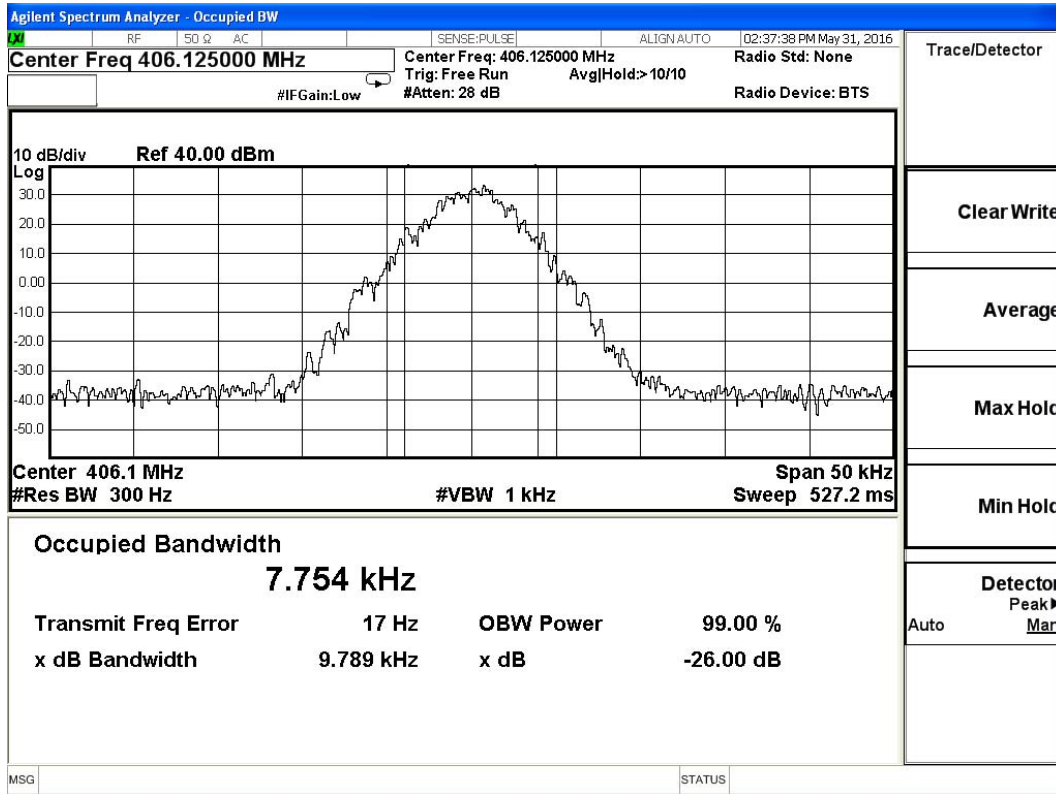

Modulation Type	Channel Separation	Operation Mode	Test Channel	Test Frequency (MHz)	Occupied Bandwidth (KHz)		Limit (KHz)	Results
					99%	26dB		
4FSK	12.5 KHz	Op 3	Ch5	456.125	7.26	8.85	11.25	PASS

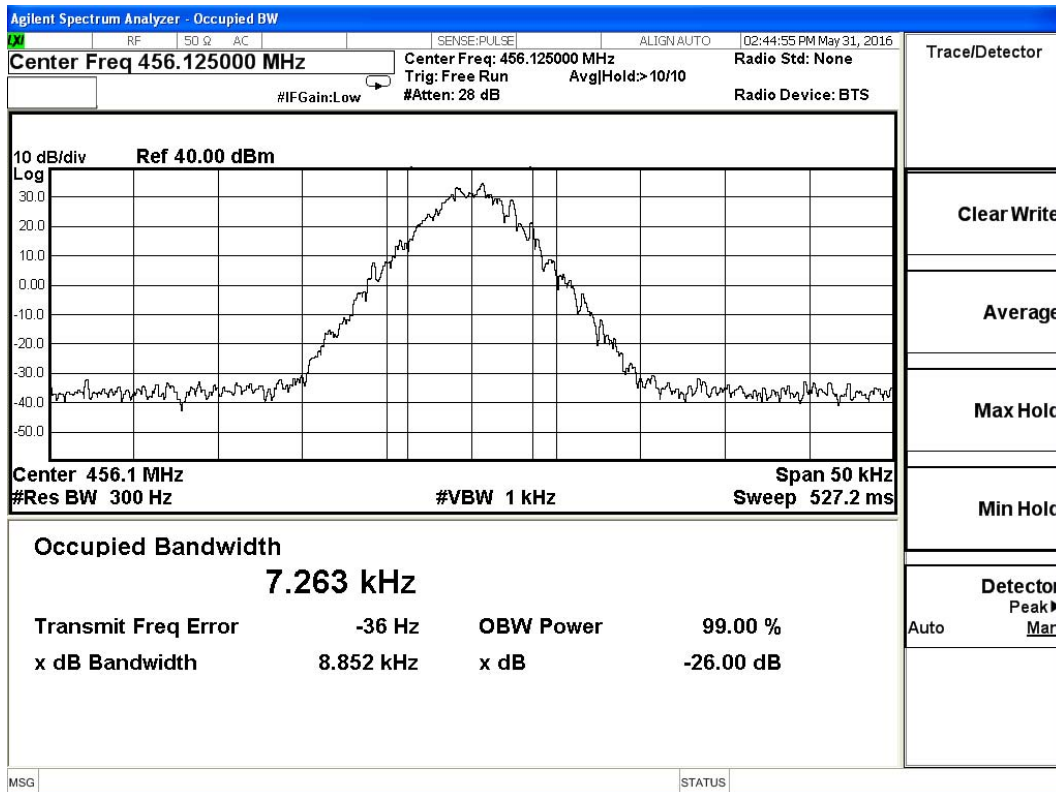

Modulation Type	Channel Separation	Operation Mode	Test Channel	Test Frequency (MHz)	Occupied Bandwidth (KHz)		Limit (KHz)	Results
					99%	26dB		
4FSK	12.5 KHz	Op 3	Ch6	469.975	7.23	9.34	11.25	PASS

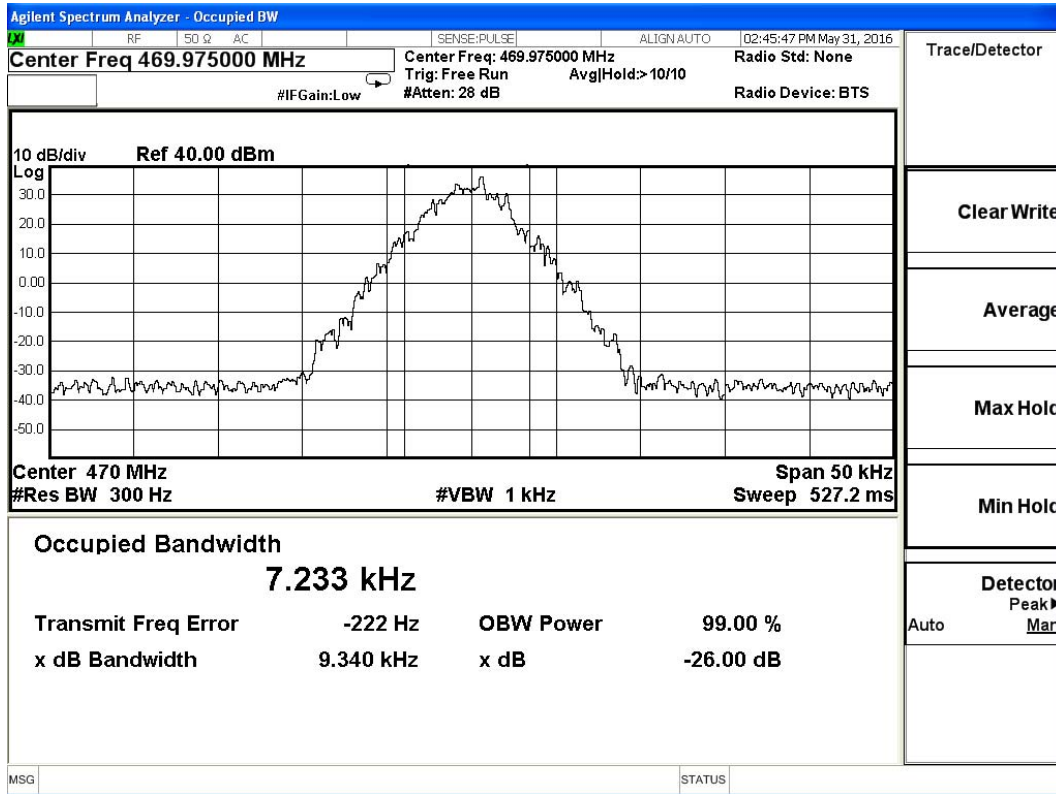

4.2.2 Emission Mask

Modulation Type	Channel Separation	Operation Mode	Test Channel	Test Frequency (MHz)	Applicable Mask	RBW (Hz)
Analog/FM	12.5 KHz	Op 1	Ch1	406.125	D	300
			Ch2	456.125	D	300
			Ch3	469.975	D	300
Digital/4FSK	12.5 KHz	Op 3	Ch1	406.125	D	300
			Ch2	456.125	D	300
			Ch3	469.975	D	300
Test Results			PASS			

Plots of Emission Mask Measurement

Referred as the attached plot hereinafter

Note:

The Black curve represents unmodulated signal.

The Blue curve represents modulated signal.

Modulation Type	Channel Separation	Operation Mode	Test Channel	Test Frequency (MHz)	Applicable Mask	RBW (Hz)	Audio Freq. (KHz)	Results
FM	12.5KHz	Op 1	Ch1	406.125	D	300	2.5	PASS

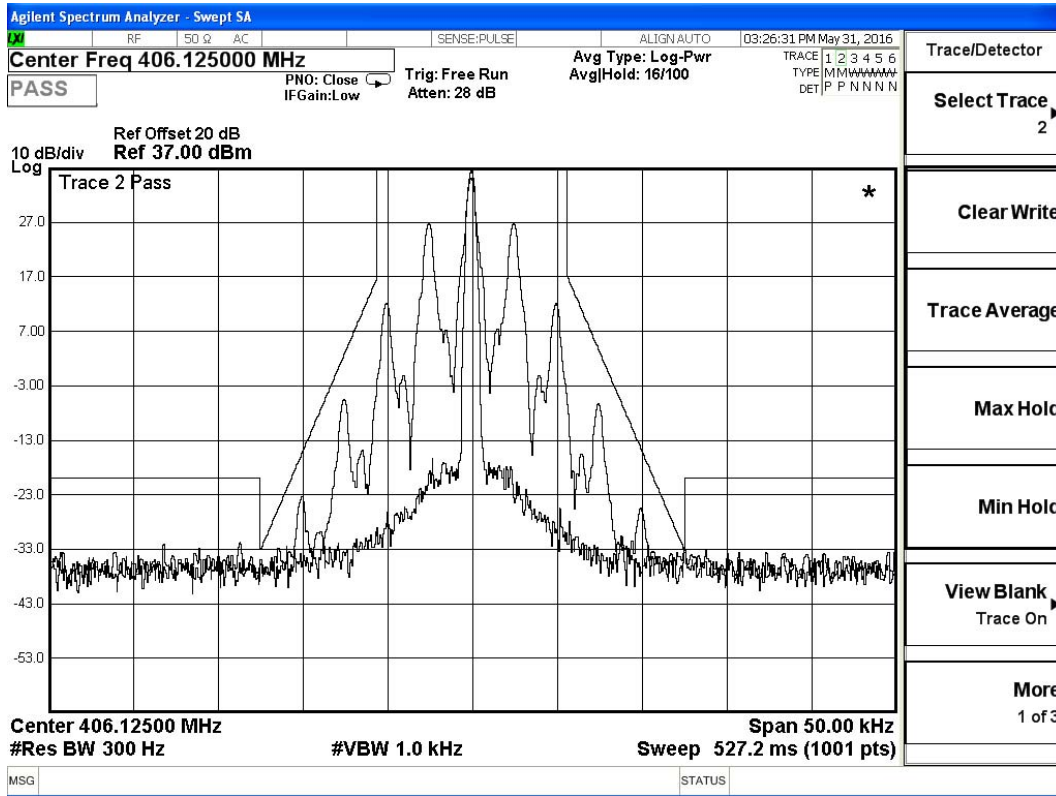

Modulation Type	Channel Separation	Operation Mode	Test Channel	Test Frequency (MHz)	Applicable Mask	RBW (Hz)	Audio Freq. (KHz)	Results
FM	12.5KHz	Op 1	Ch2	456.125	D	300	2.5	PASS

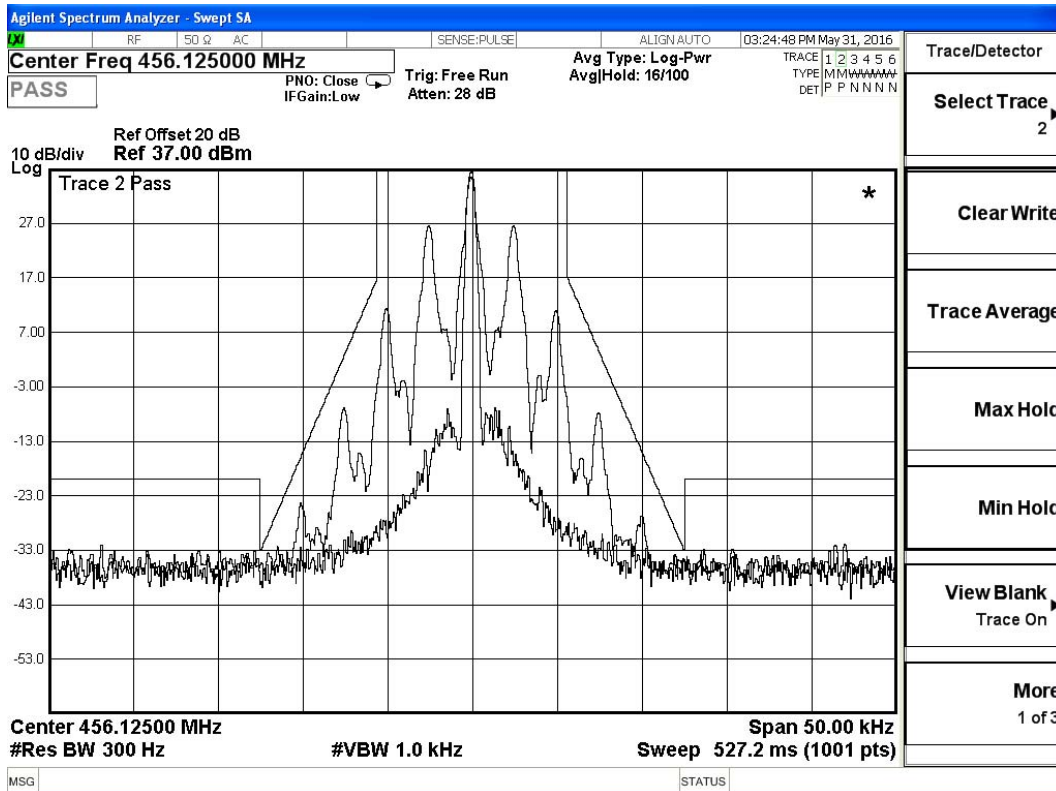

Modulation Type	Channel Separation	Operation Mode	Test Channel	Test Frequency (MHz)	Applicable Mask	RBW (Hz)	Audio Freq. (KHz)	Results
FM	12.5KHz	Op 1	Ch3	469.975	D	300	2.5	PASS

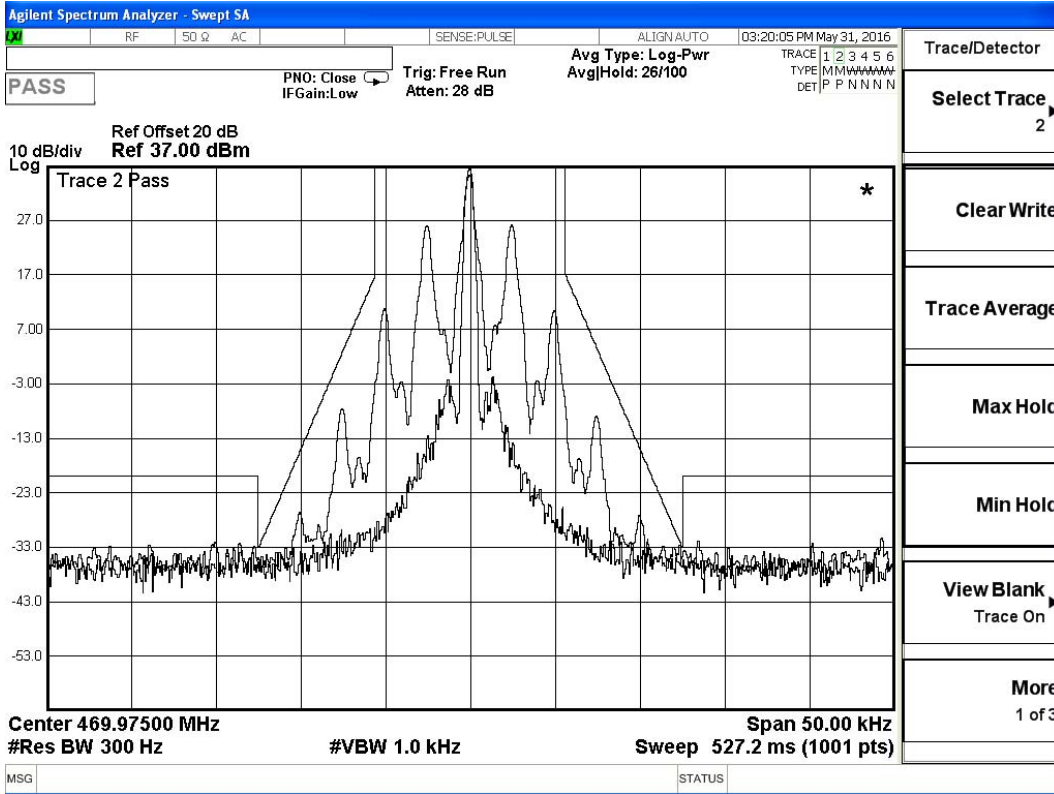

Modulation Type	Channel Separation	Operation Mode	Test Channel	Test Frequency (MHz)	Applicable Mask	RBW (Hz)	Audio Freq. (KHz)	Results
4FSK	12.5KHz	Op 3	Ch4	406.125	D	300	/	PASS

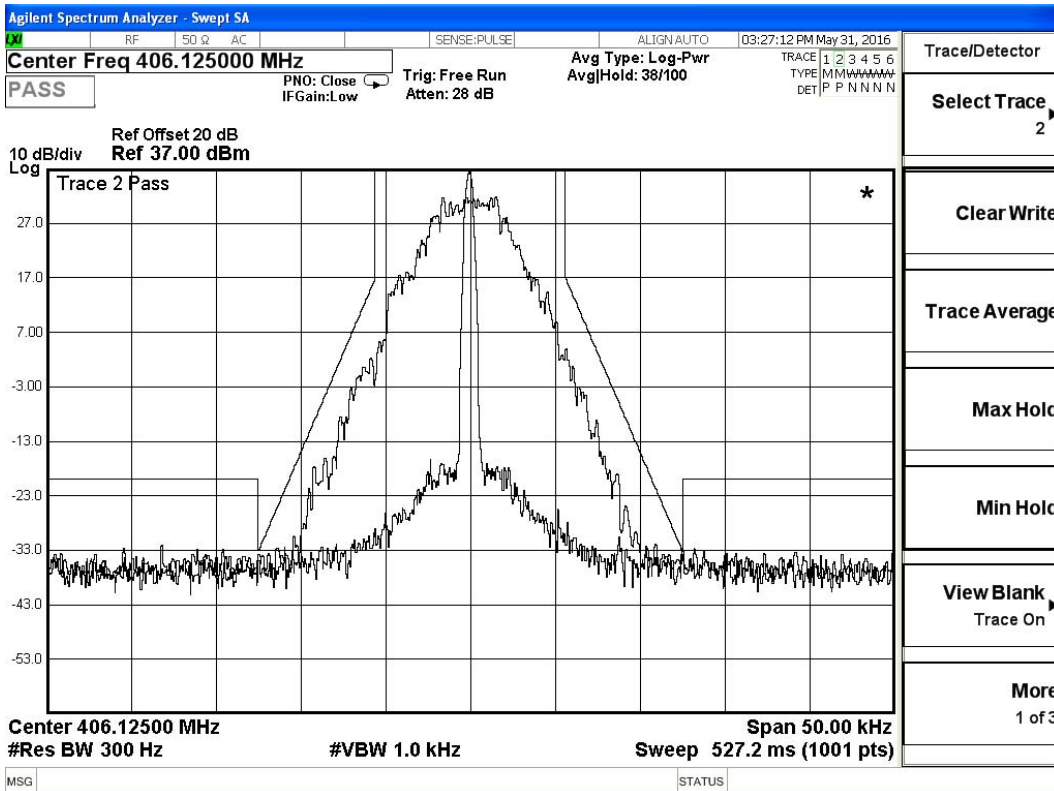

Modulation Type	Channel Separation	Operation Mode	Test Channel	Test Frequency (MHz)	Applicable Mask	RBW (Hz)	Audio Freq. (KHz)	Results
4FSK	12.5KHz	Op 3	Ch5	456.125	D	300	/	PASS

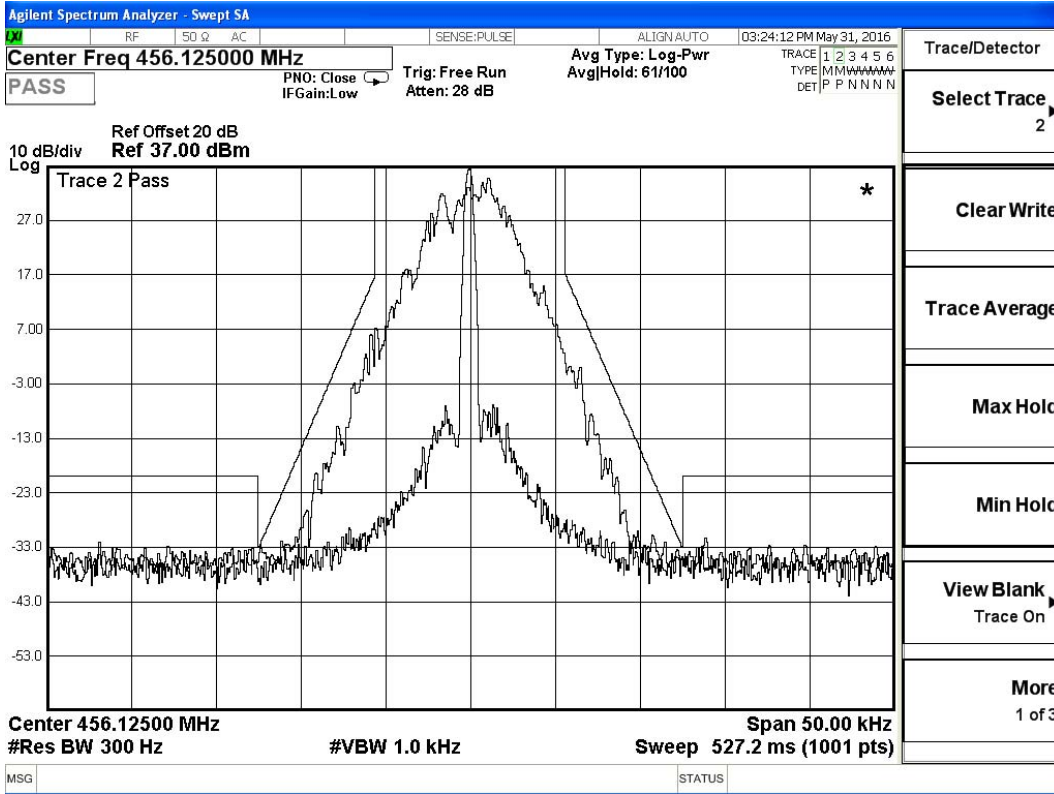

Modulation Type	Channel Separation	Operation Mode	Test Channel	Test Frequency (MHz)	Applicable Mask	RBW (Hz)	Audio Freq. (KHz)	Results
4FSK	12.5KHz	Op 3	Ch6	469.975	D	300	/	PASS

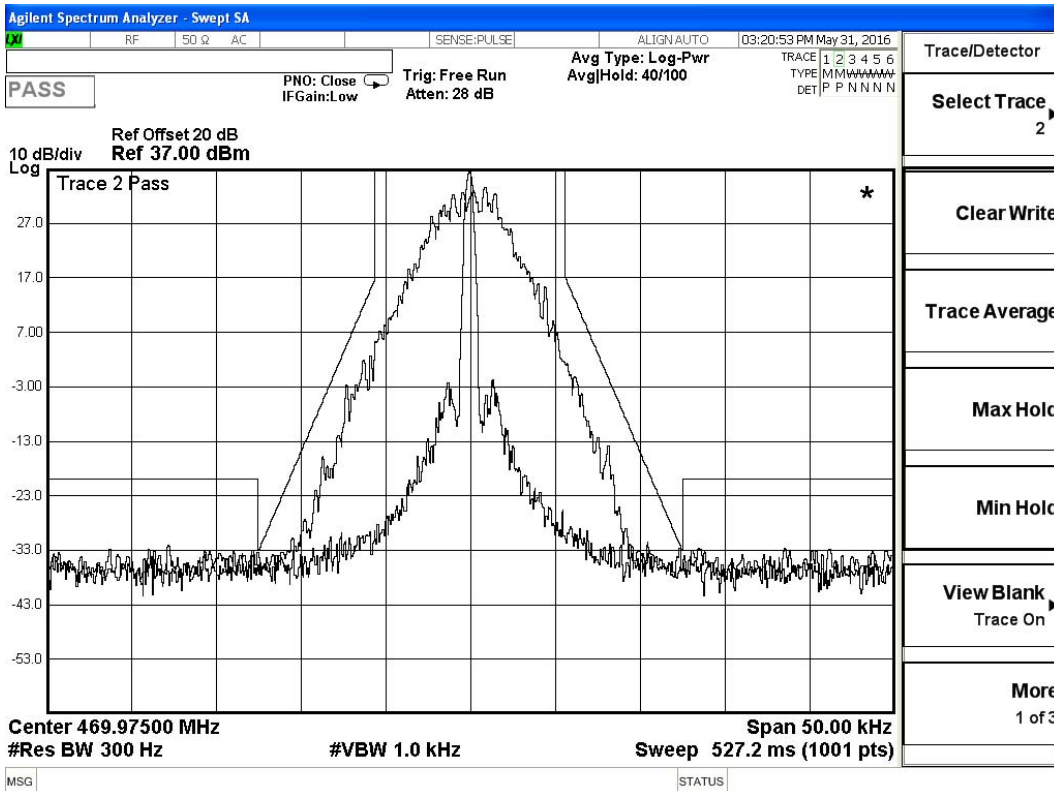

4.3. Transmitter Radiated Spurious Emission

TEST APPLICABLE

According to the TIA/EIA 603 test method, and according to Section 90.210, the power of each unwanted emission shall be less than Transmitted Power as specified below for transmitters designed to operate with 12.5 KHz channel bandwidth:

- 1 On any frequency removed from the centre of the authorized bandwidth f_0 to 5.625 KHz removed from f_0 : Zero dB
- 2 On any frequency removed from the centre of the authorized bandwidth by a displacement frequency (f_d in KHz) f_0 of more than 5.625 KHz but no more than 12.5 KHz: At least 7.27dB
- 3 On any frequency removed from the centre of the authorized bandwidth by a displacement frequency (f_d in KHz) f_0 of more than 12.5 KHz: At least $50+10 \log (P)$ dB or 70 dB, which ever is lesser attenuation.

For transmitters designed to transmit with 25 KHz channel separation and equipped with an audio low-pass filter, the power of any emission must be attenuated below the unmodulated carrier power (P) as following:

- 1 On any frequency removed from the assigned frequency by more than 50 percent, but no more than 100 percent of the authorized bandwidth: At least 25 dB.
- 2 On any frequency removed from the assigned frequency by more than 100 percent, but no more than 250 percent of the authorized bandwidth: At least 35 dB.
- 3 On any frequency removed from the assigned frequency by more than 250 percent of the authorized bandwidth: At least $43+10\text{Log} (P)$ dB.

TEST CONFIGURATION

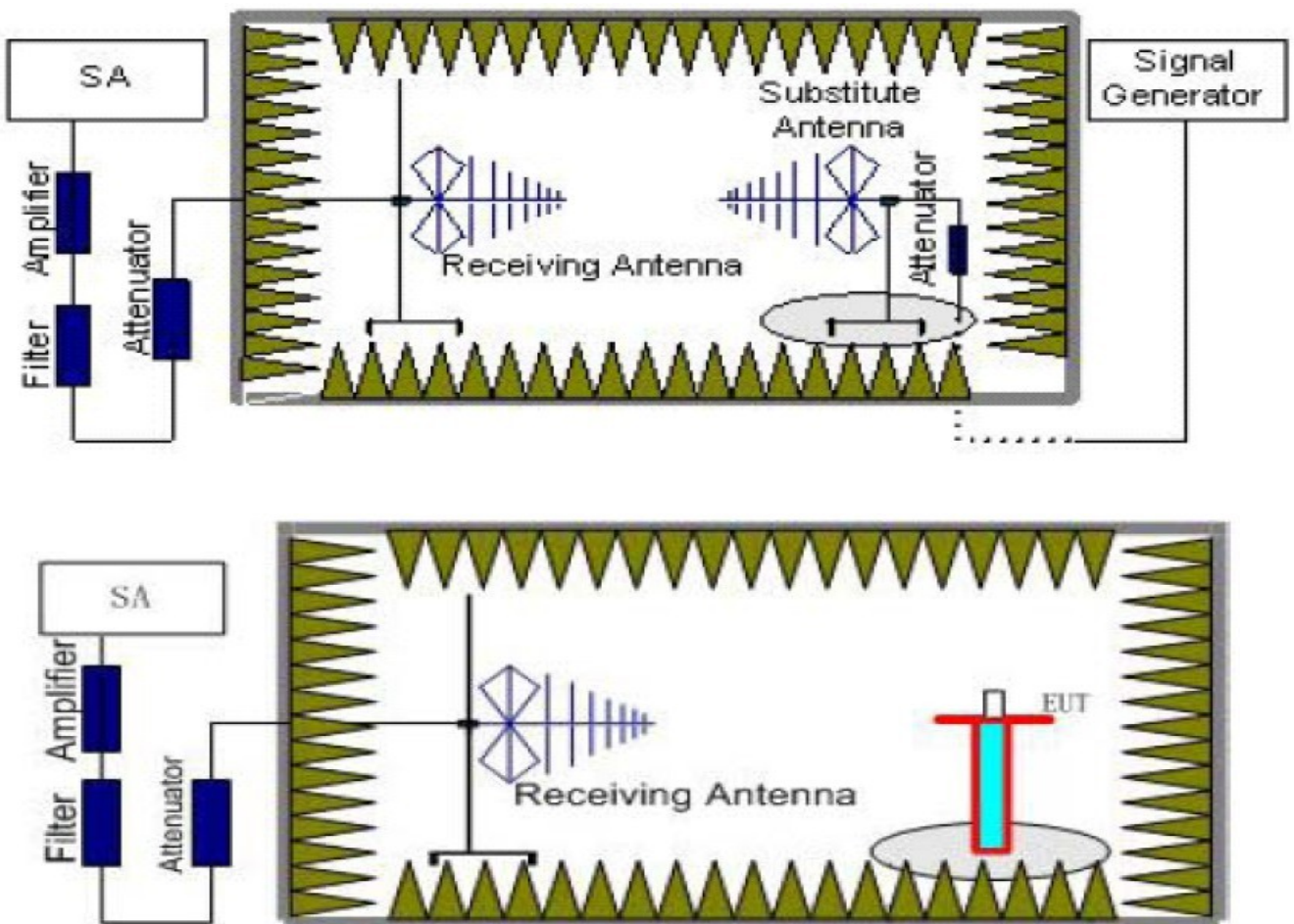

TEST PROCEDURE

- EUT was placed on a 1.50 meter high non-conductive stand at a 3 meter test distance from the receive antenna. A receiving antenna was placed on the antenna mast 3 meters from the EUT for emission measurements. The height of receiving antenna is 1.50 m. Detected emissions were maximized at each frequency by rotating the EUT through 360° and adjusting the receiving antenna polarization. The radiated emission measurements of all transmit frequencies in six channels were measured with peak detector.
- A log-periodic antenna or double-ridged waveguide horn antenna shall be substituted in place of the EUT. The log-periodic antenna will be driven by a signal generator and the level will be adjusted till the same power value on the spectrum analyzer or receiver. The level of the spurious emissions can be calculated through the level of the signal generator, cable loss, the gain of the substitution antenna and the reading of the spectrum analyzer or receiver.
- The EUT is then put into continuously transmitting mode at its maximum power level during the test. Set Test Receiver or Spectrum RBW=1MHz, VBW=3MHz for above 1GHz and RBW=100 KHz, VBW=300 KHz for 30MHz to 1GHz, and the maximum value of the receiver should be recorded as (P_r).
- The EUT shall be replaced by a substitution antenna. In the chamber, a substitution antenna for the frequency band of interest is placed at the reference point of the chamber. An RF Signal source for the frequency band of interest is connected to the substitution antenna with a cable that has been constructed to not interfere with the radiation pattern of the antenna. A power (P_{Mea}) is applied to the input of the substitution antenna, and adjusts the level of the signal generator output until the value of the receiver reach the previously recorded (P_r). The power of signal source (P_{Mea}) is recorded. The test should be performed by rotating the test item and adjusting the receiving antenna polarization.
- An amplifier should be connected to the Signal Source output port. And the cable should be connecting between the Amplifier and the Substitution Antenna. The cable loss (P_{cl}), the Substitution Antenna Gain (G_a) and the Amplifier Gain (P_{Ag}) should be recorded after test.
The measurement results are obtained as described below:
Power (EIRP) = P_{Mea} - P_{Ag} - P_{cl} - G_a
Amplifier for substitution test;
The measurement results are amending as described below:
Power (EIRP) = P_{Mea} - P_{cl} - G_a
- This value is EIRP since the measurement is calibrated using an antenna of known gain (2.15 dBi) and known input power.
- ERP can be calculated from EIRP by subtracting the gain of the dipole, ERP = EIRP-2.15dBi.
- In order to make sure test results more clearly, we set frequency range and sweep time for difference frequency range as follows table:

Working Frequency	Subrange (GHz)	RBW	VBW	Sweep time (s)
400 - 470 MHz	0.00009~0.15	1KHz	3KHz	30
	0.00015~0.03	10KHz	30KHz	10
	0.03~1	100KHz	300KHz	10
	1~3	1 MHz	3 MHz	10
	3~6	1 MHz	3 MHz	10

LIMIT

Modulation Type: FM

FCC Part 22.359, 74.462, 80.211 and 90.210 and RSS Gen, RSS 119 Issue 12:

For 12.5 kHz bandwidth:

On any frequency removed from the center of the authorized bandwidth by a displacement frequency (f_d in kHz) of more than 12.5 kHz at least:

High: $50 + 10 \log (P_{\text{watts}}) = 50 + 10 \log (4.0) = 56.02 \text{ dB}$

Low: $50 + 10 \log (P_{\text{watts}}) = 50 + 10 \log (1.0) = 50.00 \text{ dB}$

Note: In general, the worst case attenuation requirement shown above was applied.

Calculation: Limit (dBm) = EL - 50 - 10log10 (TP)

Notes: EL is the emission level of the Output Power expressed in dBm,

In this application, the EL is 36.02 dBm for Rated High power level and 30.00 dBm for Rated Lower power level;

High: Limit (dBm) = $36.99 - 50 - 10 \log_{10} (4.0) = -20 \text{ dBm}$

Low: Limit (dBm) = $30.00 - 50 - 10 \log_{10} (1.0) = -20 \text{ dBm}$

Modulation Type: 4FSK

FCC Part 22.359, 74.462, 80.211 and 90.210 and RSS Gen, RSS 119 Issue 12 (12.5 kHz Bandwidth only):

On any frequency removed from the center of the authorized bandwidth by a displacement frequency (f_d in kHz) of more than 12.5 kHz at least:

High: $50 + 10 \log (P_{\text{watts}}) = 50 + 10 \log (4.0) = 56.02 \text{ dB}$

Low: $50 + 10 \log (P_{\text{watts}}) = 50 + 10 \log (1.0) = 50.00 \text{ dB}$

Note: In general, the worst case attenuation requirement shown above was applied.

Calculation: Limit (dBm) = EL - 50 - 10log10 (TP)

Notes: EL is the emission level of the Output Power expressed in dBm,

In this application, the EL is 36.02 dBm for Rated High power level and 30.00 dBm for Rated Lower power level;

High: Limit (dBm) = $36.99 - 50 - 10 \log_{10} (4.0) = -20 \text{ dBm}$

Low: Limit (dBm) = $30.00 - 50 - 10 \log_{10} (1.0) = -20 \text{ dBm}$

Note:

1. In general, the worse case attenuation requirement shown above was applied.
2. The measurement frequency range from 9 KHz to 5 GHz.
3. *** means that the emission level is too low to be measured or at least 20 dB down than the limit.
4. Radiated spurious tested ERP for below 1GHz and EIRP for above 1GHz.

TEST RESULTS

Remark:

1. We tested Op 1 to Op 4, recorded worst case at Op 1 and Op 3.

Modulation Type: FM							
Operation Mode: Op 1				Channel Separation: 12.5KHz			
Test Channel: Ch1				Test Frequency: 406.125MHz			
Frequency (MHz)	PMea (dBm)	Path Loss	Antenna Gain	Correction (dB)	Peak EIRP (dBm)	Limit (dBm)	Polarization
812.250	-50.88	0.87	6.42	2.15	-47.48	-20.00	H
1215.375	-47.42	1.02	7.35	2.15	-43.24	-20.00	H
2030.625	-57.39	1.10	8.26	2.15	-52.38	-20.00	H
...	H
812.250	-49.81	0.87	6.42	2.15	-46.41	-20.00	V
1215.375	-48.70	1.02	7.35	2.15	-44.52	-20.00	V
2030.625	-57.16	1.10	8.26	2.15	-52.15	-20.00	V
...	V

Modulation Type: FM							
Operation Mode: Op 1				Channel Separation:12.5KHz			
Test Channel: Ch2				Test Frequency: 456.125MHz			
Frequency (MHz)	PMea (dBm)	Path Loss	Antenna Gain	Correction (dB)	Peak EIRP (dBm)	Limit (dBm)	Polarization
912.250	-52.43	0.92	6.80	2.15	-48.70	-20.00	H
1368.375	-43.34	1.06	7.89	2.15	-38.66	-20.00	H
2280.625	-60.42	1.12	8.12	2.15	-55.57	-20.00	H
...	H
912.250	-50.91	0.92	6.80	2.15	-47.18	-20.00	V
1368.375	-46.86	1.06	7.89	2.15	-42.18	-20.00	V
2280.625	-58.62	1.12	8.12	2.15	-53.77	-20.00	V
...	V

Modulation Type: FM							
Operation Mode: Op 1				Channel Separation:12.5KHz			
Test Channel: Ch3				Test Frequency: 469.975MHz			
Frequency (MHz)	PMea (dBm)	Path Loss	Antenna Gain	Correction (dB)	Peak EIRP (dBm)	Limit (dBm)	Polarization
939.950	-53.52	0.95	6.80	2.15	-49.82	-20.00	H
1409.925	-44.59	1.10	7.91	2.15	-39.93	-20.00	H
2349.875	-59.88	1.21	8.25	2.15	-54.99	-20.00	H
...	H
939.950	-53.64	0.95	6.80	2.15	-49.94	-20.00	V
1409.925	-42.99	1.10	7.91	2.15	-38.33	-20.00	V
2349.875	-58.45	1.21	8.25	2.15	-53.56	-20.00	V
...	V

Modulation Type: 4FSK							
Operation Mode: Op 3				Channel Separation:12.5KHz			
Test Channel: Ch4				Test Frequency:406.125MHz			
Frequency (MHz)	PMea (dBm)	Path Loss	Antenna Gain	Correction (dB)	Peak EIRP (dBm)	Limit (dBm)	Polarization
812.250	-51.88	0.87	6.42	2.15	-48.48	-20.00	H
1215.375	-45.19	1.02	7.35	2.15	-41.01	-20.00	H
2030.625	-60.55	1.10	8.26	2.15	-55.54	-20.00	H
...	H
812.250	-50.99	0.87	6.42	2.15	-47.59	-20.00	V
1215.375	-43.93	1.02	7.35	2.15	-39.75	-20.00	V
2030.625	-61.96	1.10	8.26	2.15	-56.95	-20.00	V
...	V

Modulation Type: 4FSK							
Operation Mode: Op 3				Channel Separation:12.5KHz			
Test Channel: Ch5				Test Frequency: 456.125MHz			
Frequency (MHz)	PMea (dBm)	Path Loss	Antenna Gain	Correction (dB)	Peak EIRP (dBm)	Limit (dBm)	Polarization
912.250	-51.88	0.92	6.80	2.15	-48.15	-20.00	H
1368.375	-46.02	1.06	7.89	2.15	-41.34	-20.00	H
2280.625	-55.90	1.12	8.12	2.15	-51.05	-20.00	H
...	H
912.250	-52.67	0.92	6.80	2.15	-48.94	-20.00	V
1368.375	-43.90	1.06	7.89	2.15	-39.22	-20.00	V
2280.625	-58.87	1.12	8.12	2.15	-54.02	-20.00	V
...	V

Modulation Type: 4FSK

Operation Mode: Op 3				Channel Separation:12.5KHz			
Test Channel: Ch6				Test Frequency: 469.975MHz			
Frequency (MHz)	PMea (dBm)	Path Loss	Antenna Gain	Correction (dB)	Peak EIRP (dBm)	Limit (dBm)	Polarization
939.950	-51.35	0.95	6.80	2.15	-47.65	-20.00	H
1409.925	-45.88	1.10	7.91	2.15	-41.22	-20.00	H
2349.875	-58.87	1.21	8.25	2.15	-53.98	-20.00	H
...	H
939.950	-53.80	0.95	6.80	2.15	-50.10	-20.00	V
1409.925	-44.89	1.10	7.91	2.15	-40.23	-20.00	V
2349.875	-62.68	1.21	8.25	2.15	-57.79	-20.00	V
...	V

4.4. Spurious Emission on Antenna Port

TEST APPLICABLE

The same as Section 4.3

TEST PROCEDURE

The RF output of the EUT was connected to a spectrum analyzer through appropriate attenuation. The resolution bandwidth of the spectrum analyzer was set to 100 kHz. Sufficient scans were taken to show any out of band emission up to 10th. Harmonic for the lower and the highest frequency range. Set RBW=1KHz/VBW=3KHz in the frequency band 9KHz to 150KHz, RBW=10KHz/VBW=30 KHz in the frequency band 150KHz to 30 MHz, RBW=100 kHz/VBW=300 kHz in the frequency band 30MHz to 1GHz, and RBW=1MHz/VBW=3MHz from the 1GHz to 10th Harmonic.

The audio input was set to 0 to get the unmodulated carrier, the resulting picture is print out for each channel separation.

TEST CONFIGURATION

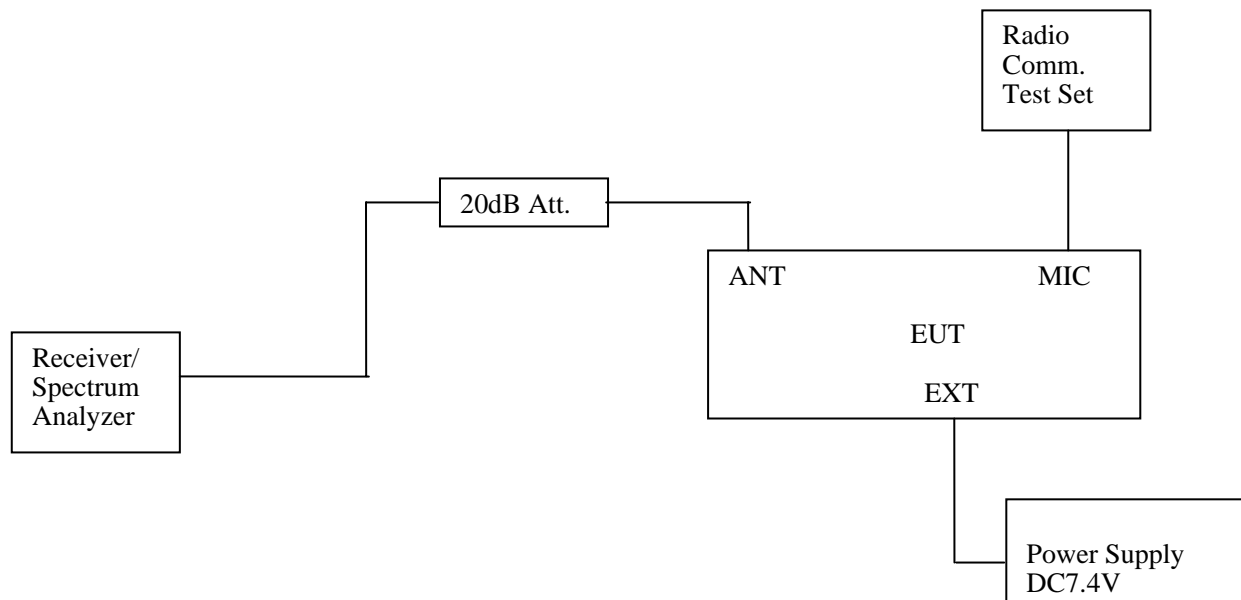

LIMIT

Modulation Type: FM

FCC Part 22.359, 74.462, 80.211 and 90.210 and RSS Gen, RSS 119 Issue 12:

For 12.5 kHz bandwidth:

On any frequency removed from the center of the authorized bandwidth by a displacement frequency (f_d in kHz) of more than 12.5 kHz at least:

High: $50 + 10 \log (P_{\text{watts}}) = 50 + 10 \log (4.0) = 56.02 \text{ dB}$

Low: $50 + 10 \log (P_{\text{watts}}) = 50 + 10 \log (1.0) = 50.00 \text{ dB}$

Note: In general, the worst case attenuation requirement shown above was applied.

Calculation: Limit (dBm) = EL - 50 - 10log10 (TP)

Notes: EL is the emission level of the Output Power expressed in dBm,

In this application, the EL is 36.02 dBm for Rated High power level and 30.00 dBm for Rated Lower power level;

High: Limit (dBm) = 36.99 - 50 - 10log10 (4.0) = -20 dBm

Low: Limit (dBm) = $30.00 - 50 - 10 \log_{10}(1.0) = -20$ dBm

Modulation Type: 4FSK

FCC Part 22.359, 74.462, 80.211 and 90.210 and RSS Gen, RSS 119 Issue 12 (12.5 kHz Bandwidth only):

On any frequency removed from the center of the authorized bandwidth by a displacement frequency (f_d in kHz) of more than 12.5 kHz at least:

High: $50 + 10 \log(P_{\text{watts}}) = 50 + 10 \log(4.0) = 56.02$ dB

Low: $50 + 10 \log(P_{\text{watts}}) = 50 + 10 \log(1.0) = 50.00$ dB

Note: In general, the worst case attenuation requirement shown above was applied.

Calculation: Limit (dBm) = $EL - 50 - 10 \log_{10}(TP)$

Notes: EL is the emission level of the Output Power expressed in dBm,

In this application, the EL is 36.02 dBm for Rated High power level and 30.00 dBm for Rated Lower power level;

High: Limit (dBm) = $36.99 - 50 - 10 \log_{10}(4.0) = -20$ dBm

Low: Limit (dBm) = $30.00 - 50 - 10 \log_{10}(1.0) = -20$ dBm

Note:

1. In general, the worse case attenuation requirement shown above was applied.

2. The measurement frequency range from 9 KHz to 6GHz.

TEST RESULTS

Operation Mode	Test Channel	Test Frequency (MHz)	Maximum Conducted Spurious Emissions Below 1GHz		Maximum Conducted Spurious Emissions Above 1GHz	
			Frequency (MHz)	Data (dBm)	Frequency (MHz)	Data (dBm)
Op 1	Ch1	406.125	811.82	-36.31	1220.00	-33.27
	Ch2	456.125	912.70	-34.66	1368.00	-26.99
	Ch3	469.975	939.86	-34.94	1412.00	-26.29
Op 3	Ch4	406.125	811.82	-35.75	1220.00	-34.35
	Ch5	456.125	912.70	-35.05	1368.00	-25.97
	Ch6	469.975	939.86	-34.64	1412.00	-26.28
Limit			-20dBm for 12.5KHz Channel Separation			
Test Results			PASS			

Plots of Spurious Emission on Antenna Port Measurement

Operation Mode	Test Channel	Test Frequency (MHz)	Maximum Conducted Spurious Emissions Below 1GHz		Maximum Conducted Spurious Emissions Above 1GHz		Limit (dBm)
			Frequency (MHz)	Data (dBm)	Frequency (MHz)	Data (dBm)	
Op 1	Ch1	406.125	811.82	-36.31	1220.00	-33.27	-20.00

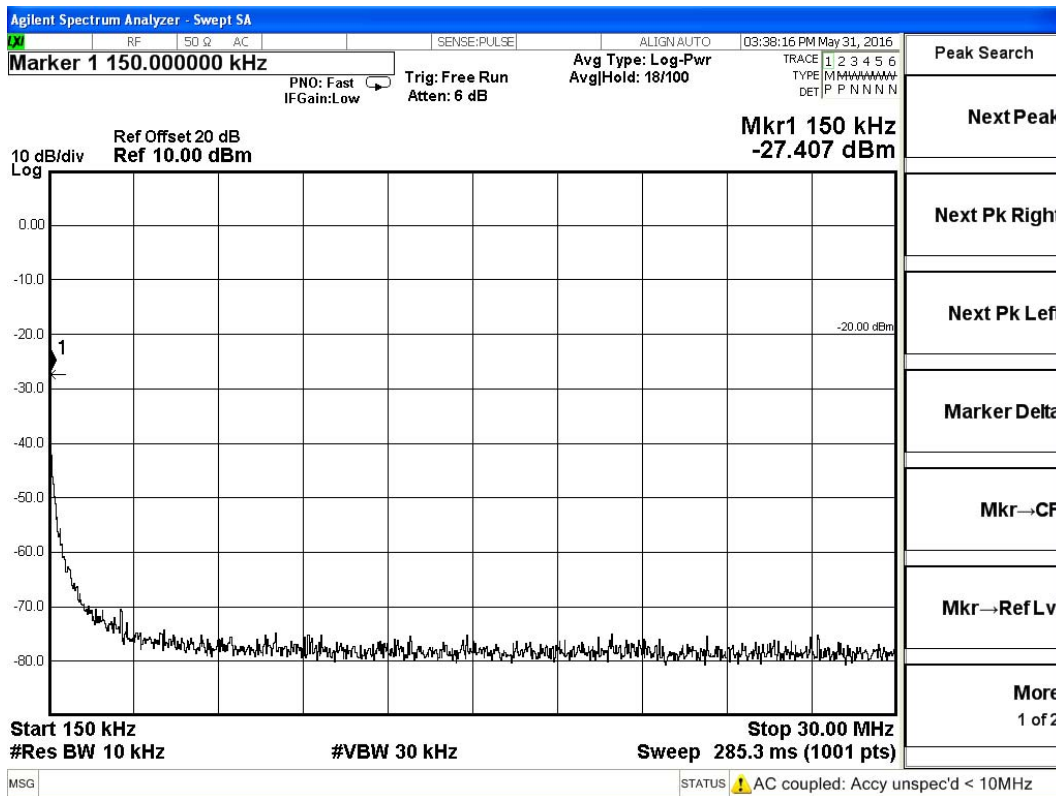
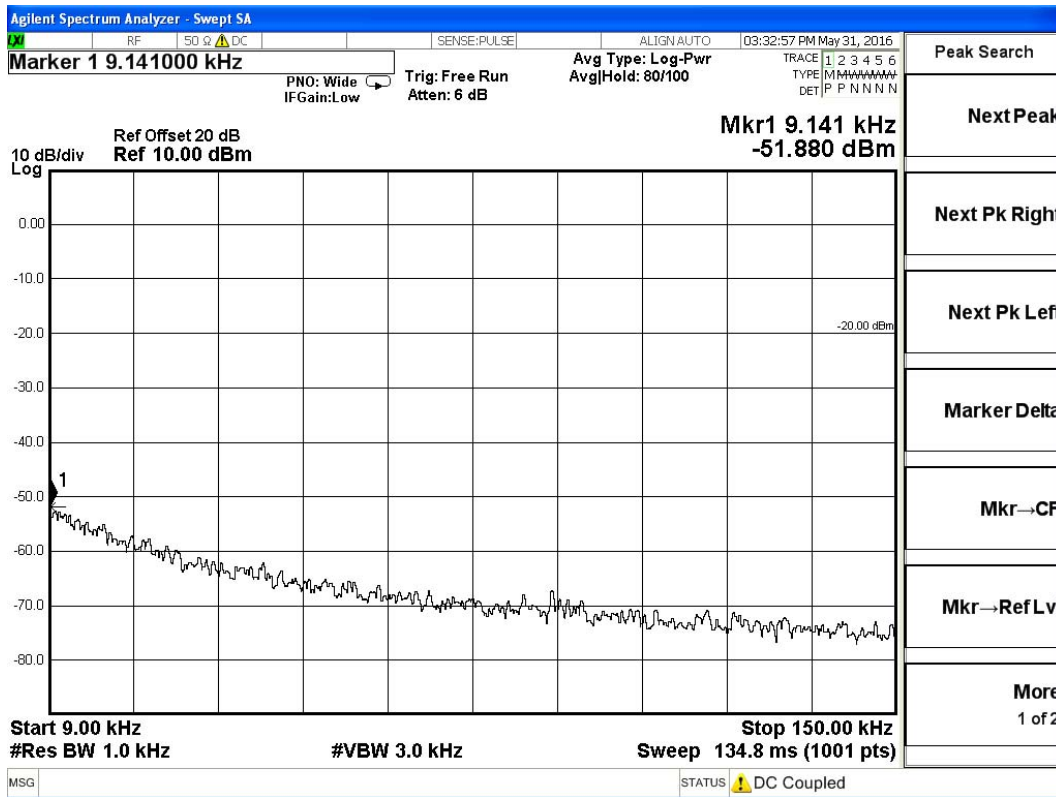

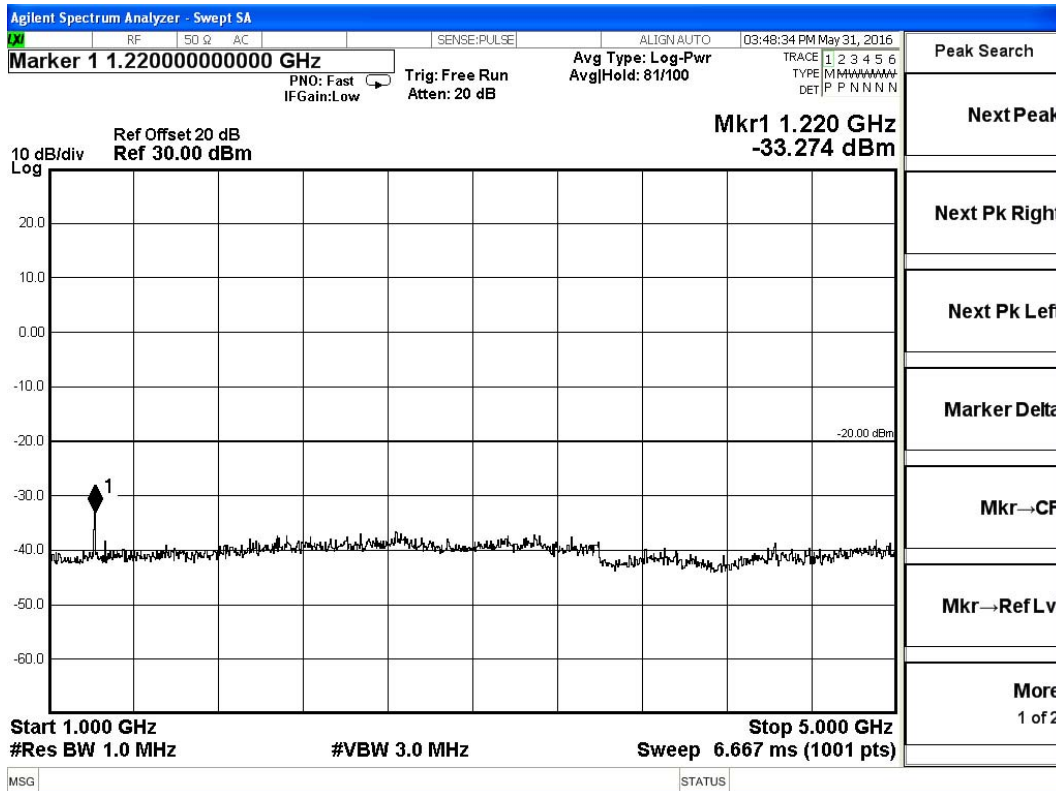
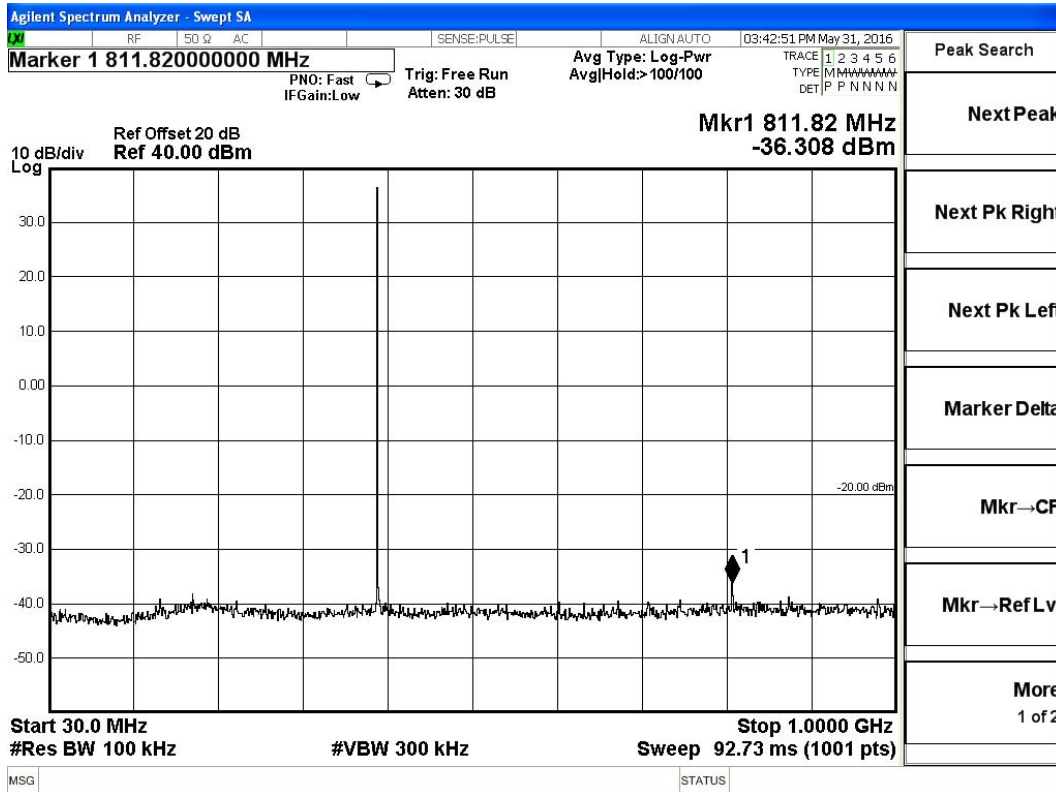

Operation Mode	Test Channel	Test Frequency (MHz)	Maximum Conducted Spurious Emissions Below 1GHz		Maximum Conducted Spurious Emissions Above 1GHz		Limit (dBm)
			Frequency (MHz)	Data (dBm)	Frequency (MHz)	Data (dBm)	
Op 1	Ch2	456.125	912.70	-34.66	1368.00	-26.99	-20.00

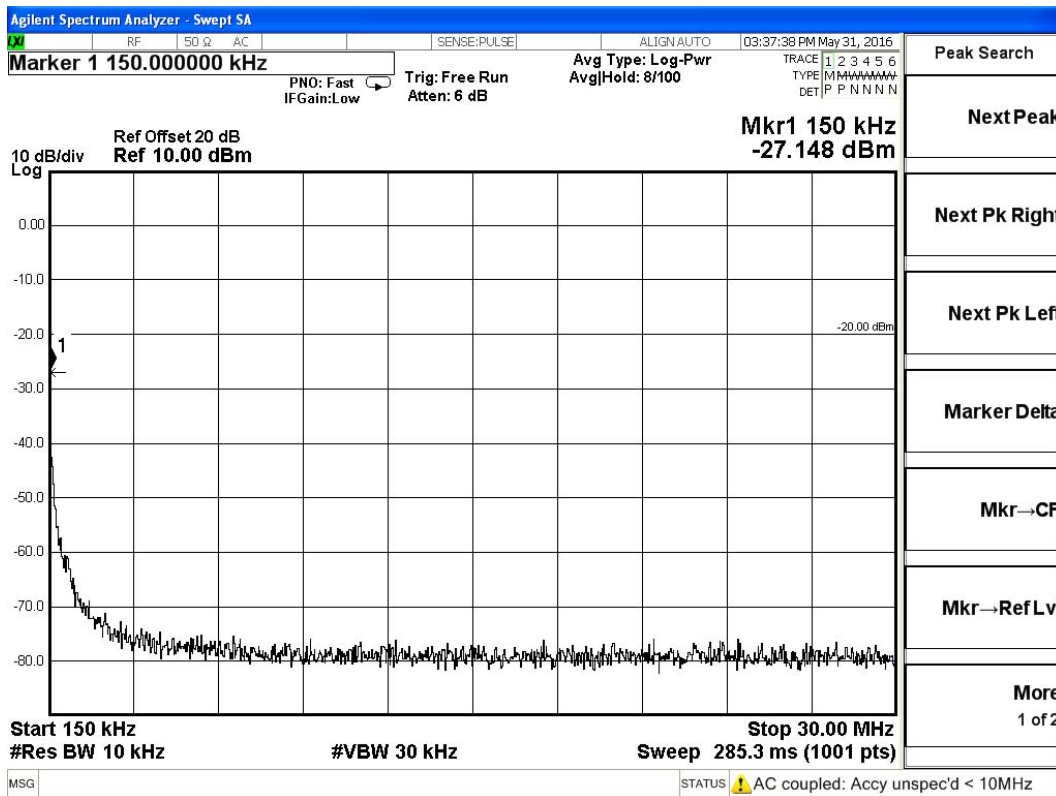
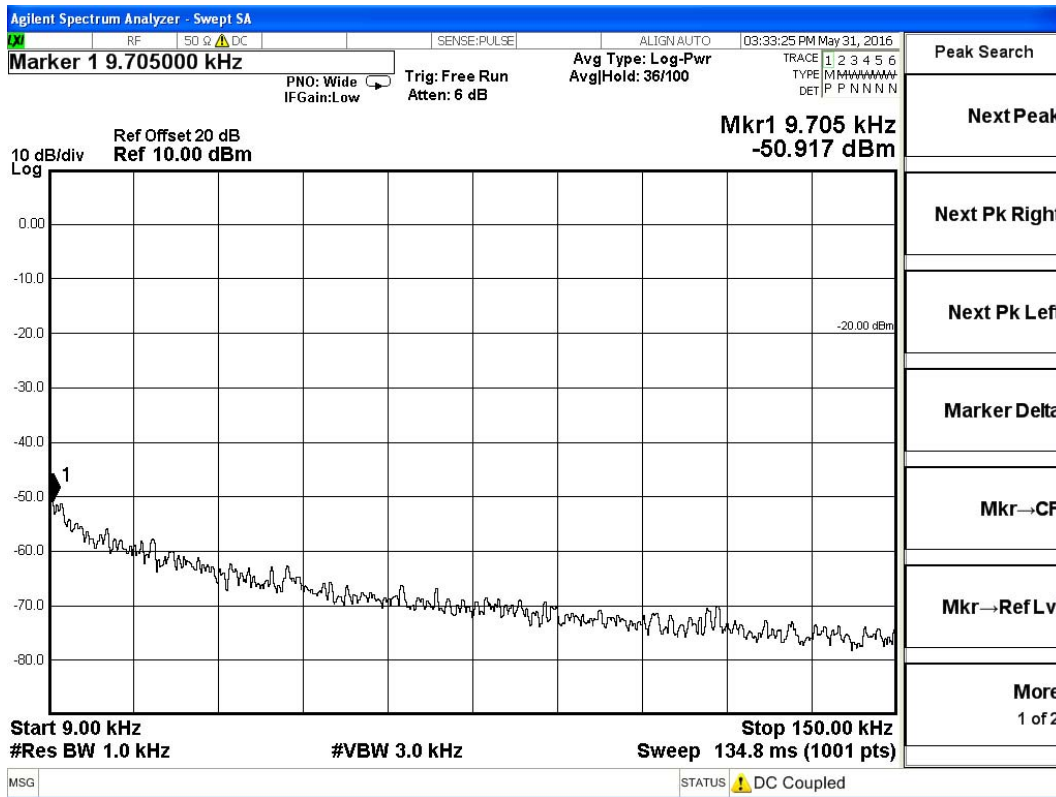

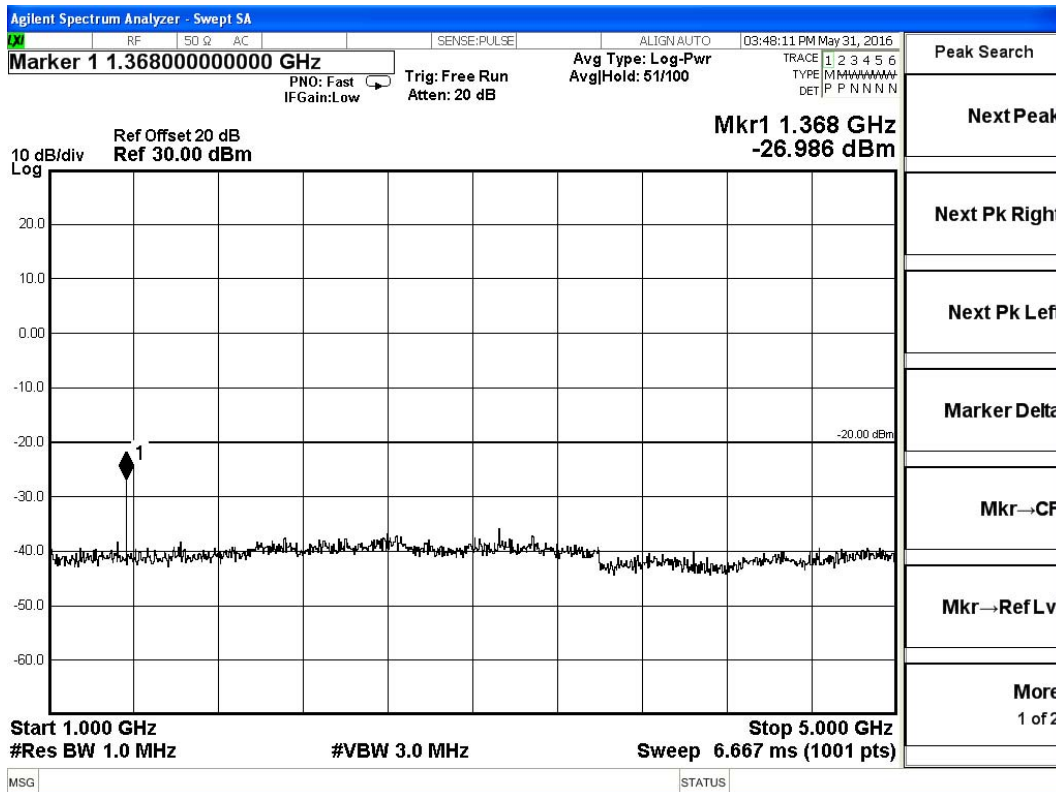
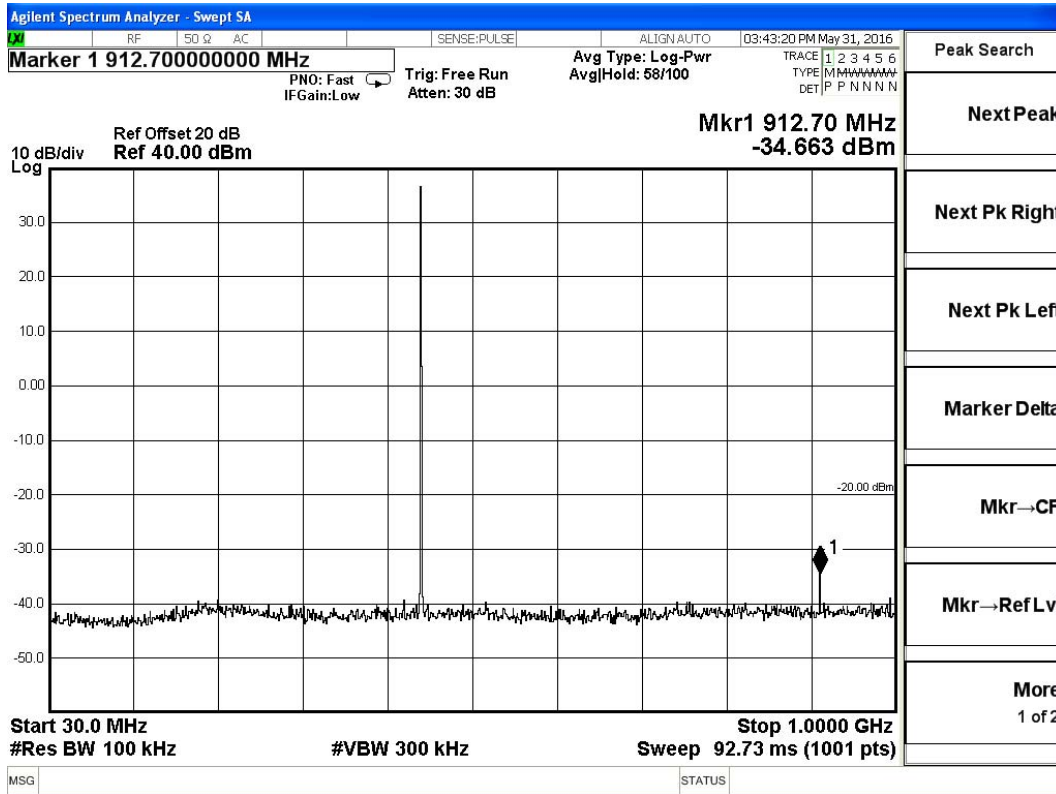

Operation Mode	Test Channel	Test Frequency (MHz)	Maximum Conducted Spurious Emissions Below 1GHz		Maximum Conducted Spurious Emissions Above 1GHz		Limit (dBm)
			Frequency (MHz)	Data (dBm)	Frequency (MHz)	Data (dBm)	
Op 1	Ch3	469.975	939.86	-34.94	1412.00	-26.29	-20.00

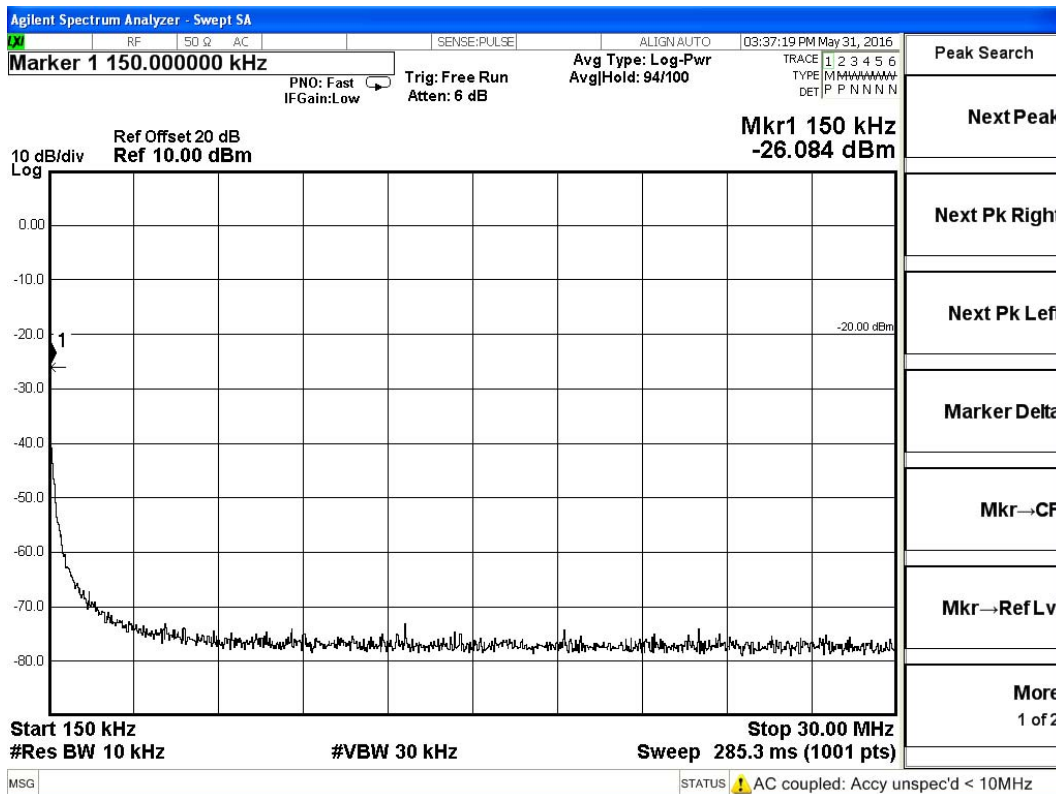
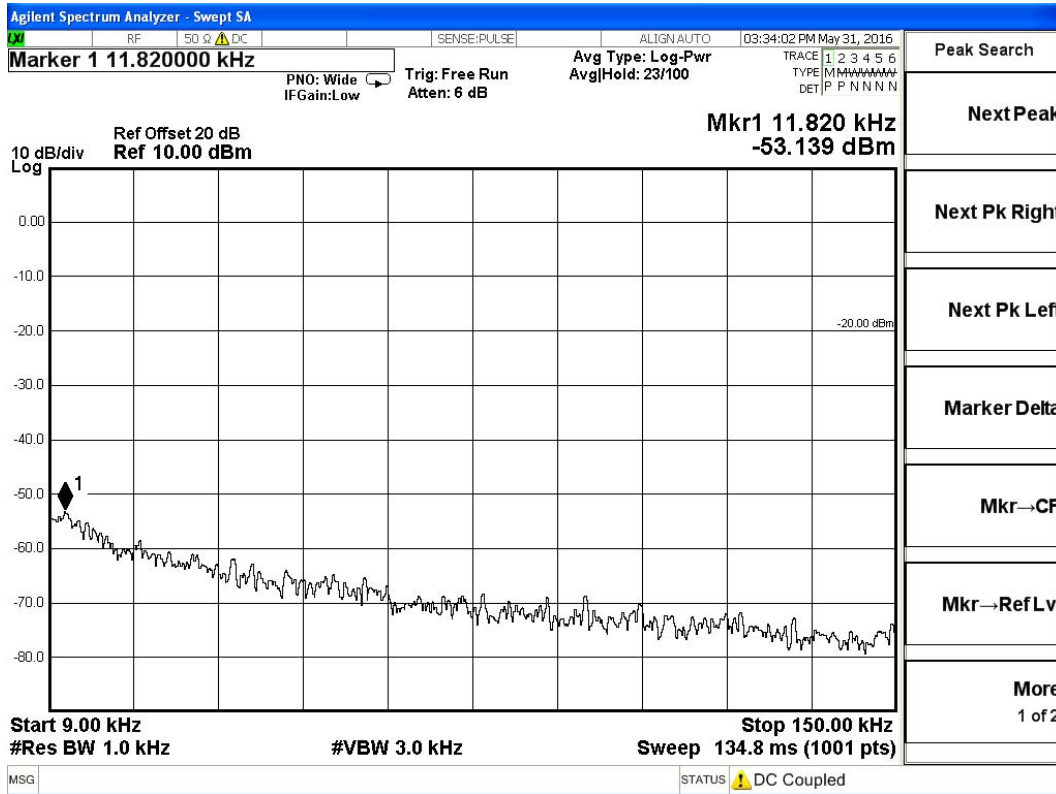

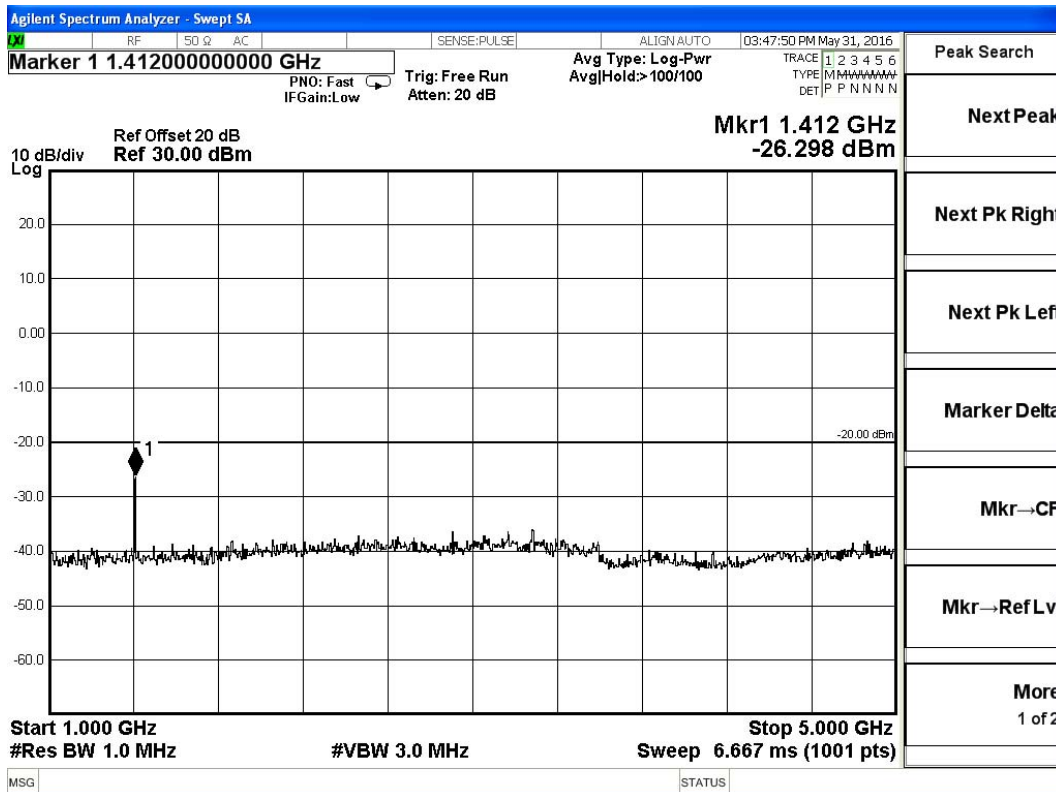
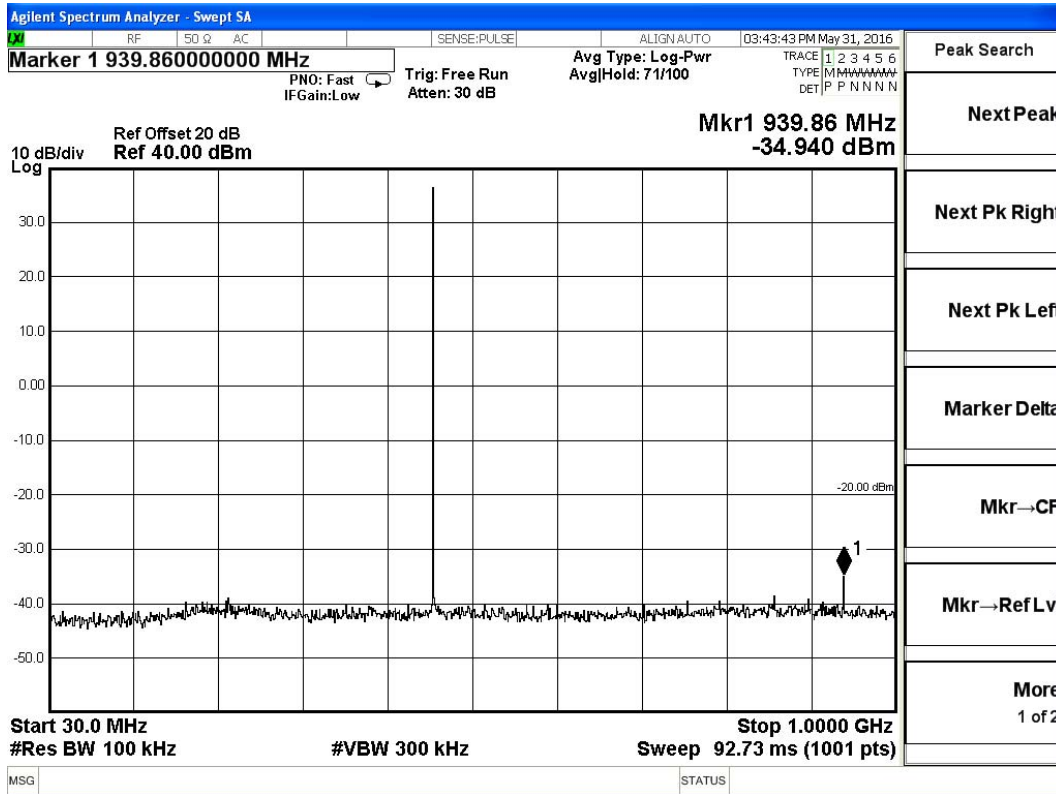

Operation Mode	Test Channel	Test Frequency (MHz)	Maximum Conducted Spurious Emissions Below 1GHz		Maximum Conducted Spurious Emissions Above 1GHz		Limit (dBm)
			Frequency (MHz)	Data (dBm)	Frequency (MHz)	Data (dBm)	
Op 3	Ch4	406.125	811.82	-35.75	1220.00	-34.35	-20.00

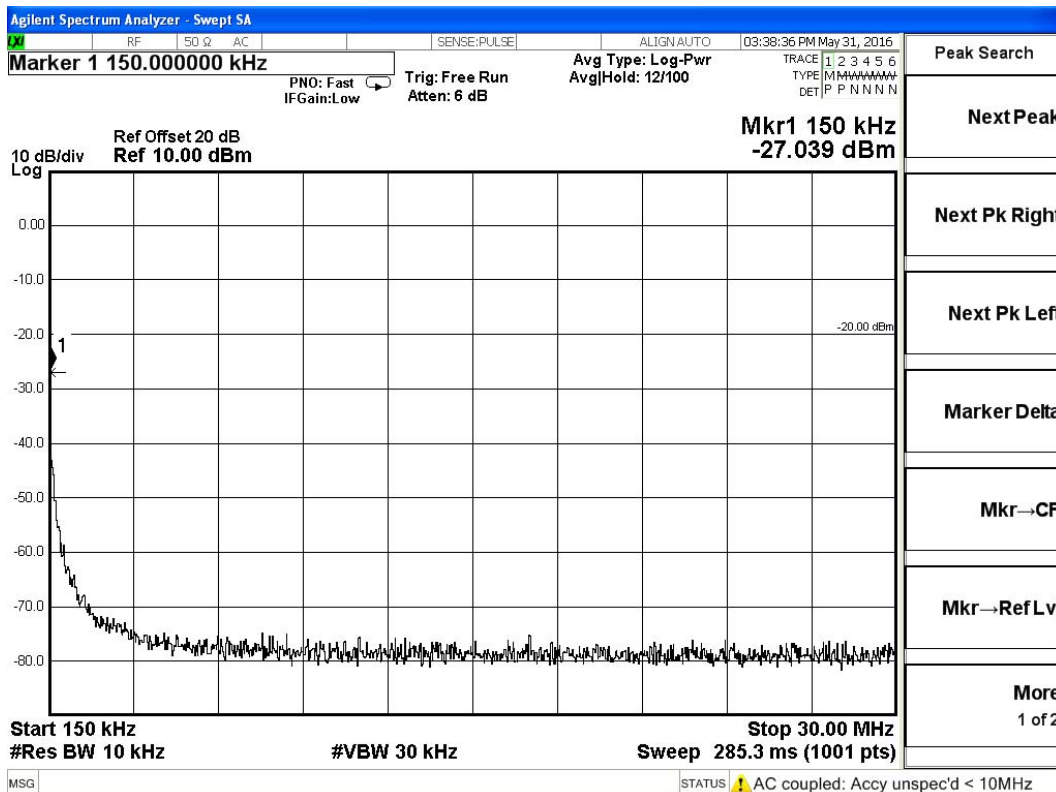
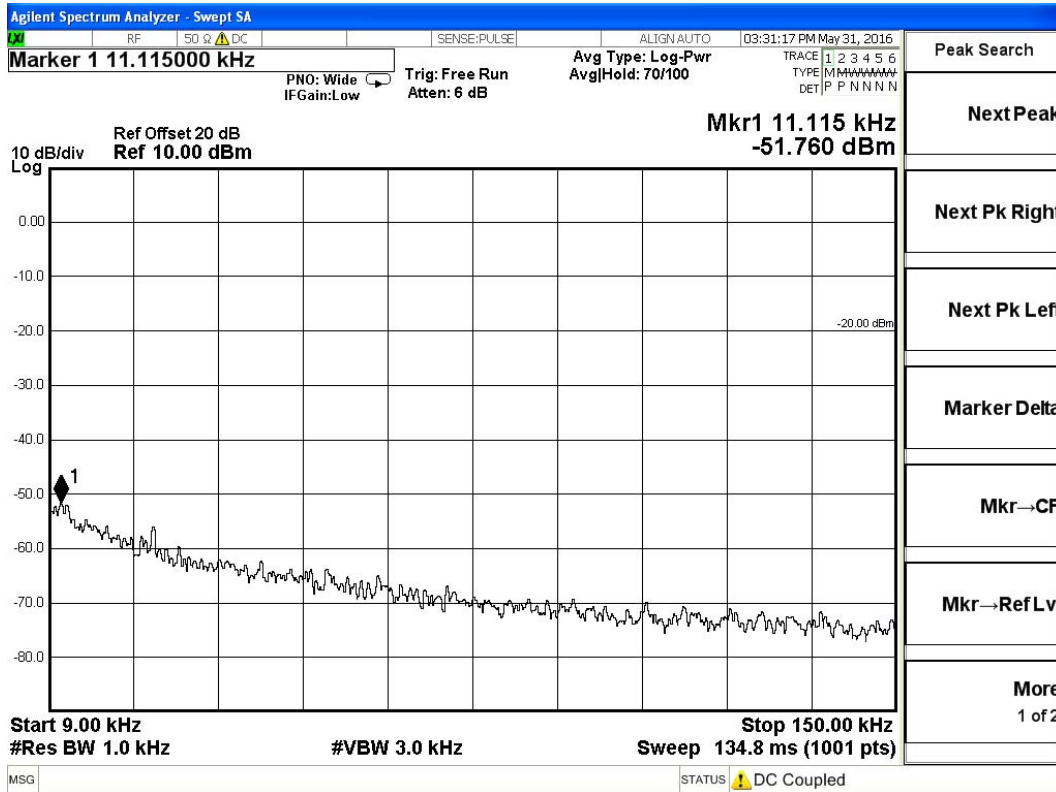

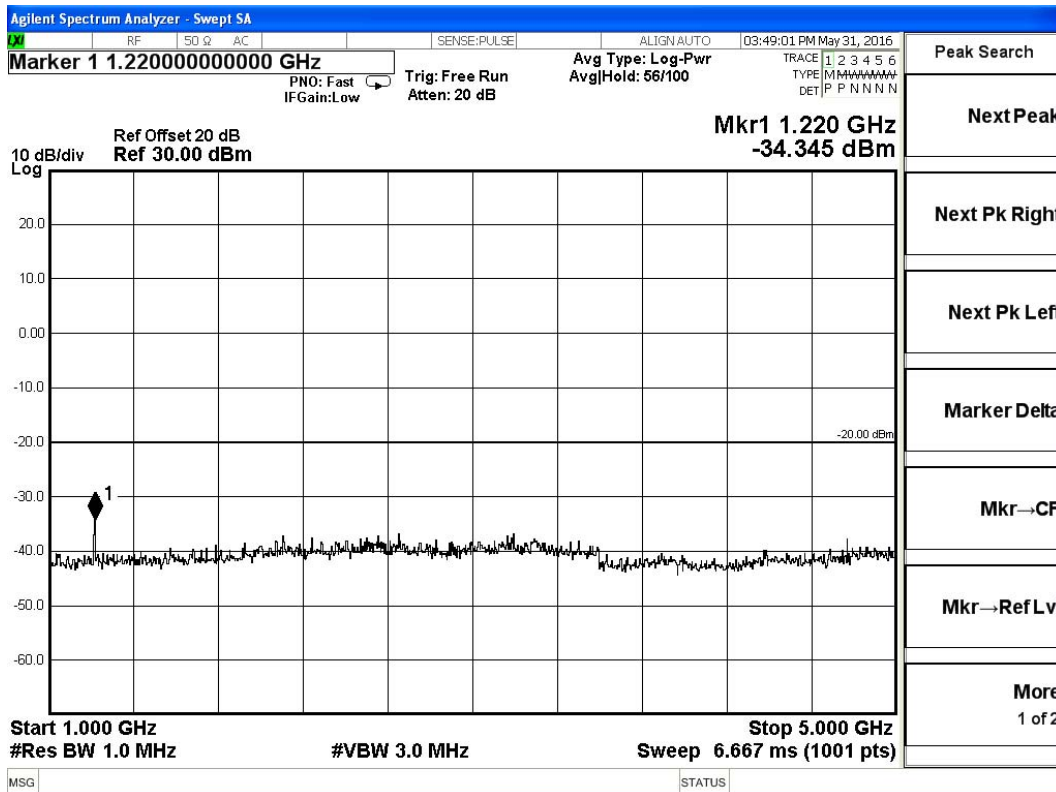
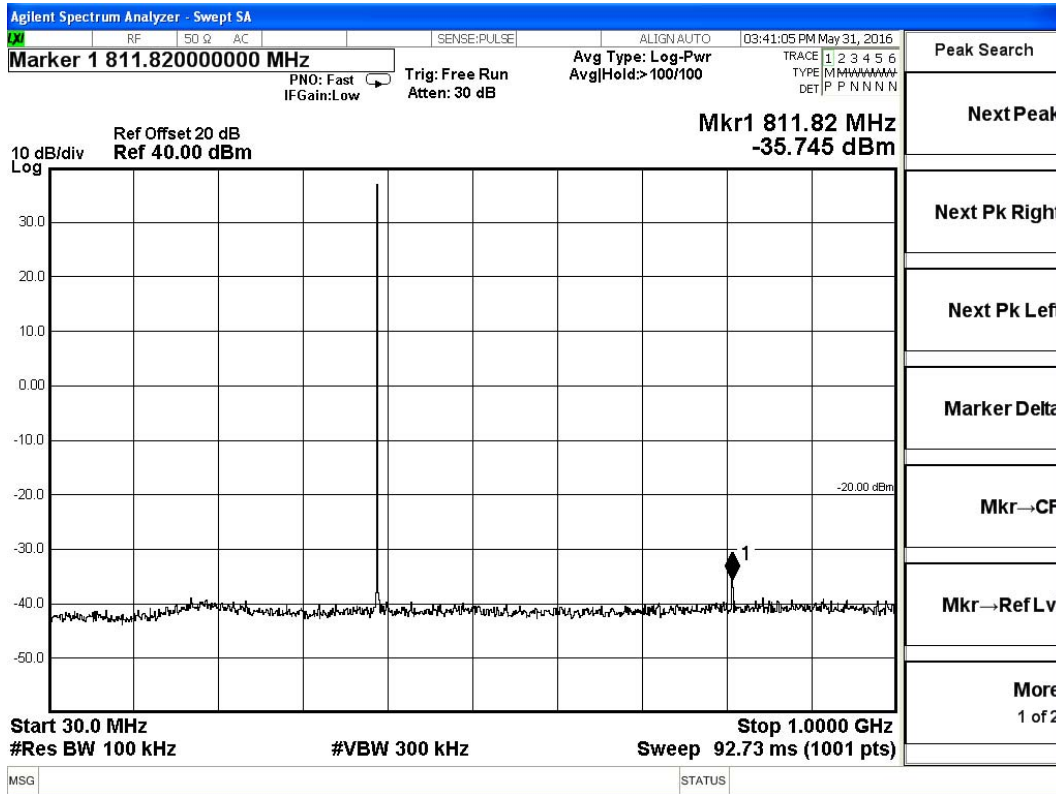

Operation Mode	Test Channel	Test Frequency (MHz)	Maximum Conducted Spurious Emissions Below 1GHz		Maximum Conducted Spurious Emissions Above 1GHz		Limit (dBm)
			Frequency (MHz)	Data (dBm)	Frequency (MHz)	Data (dBm)	
Op 3	Ch5	456.125	912.70	-35.05	1368.00	-25.97	-20.00

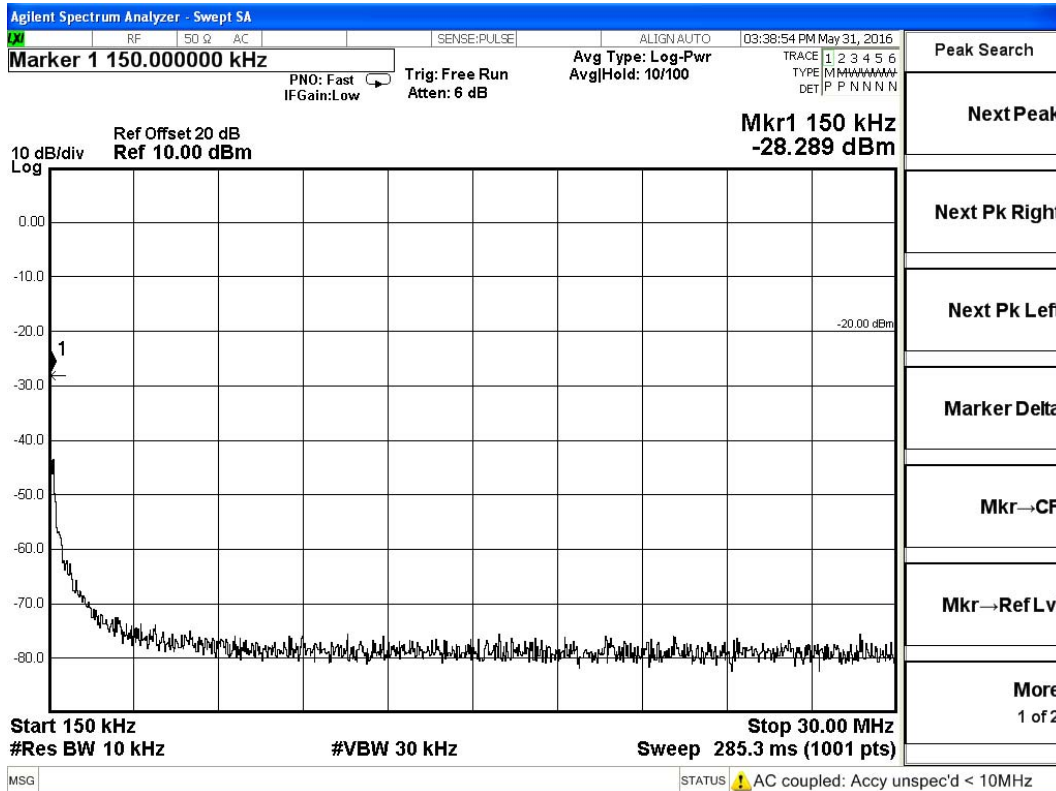
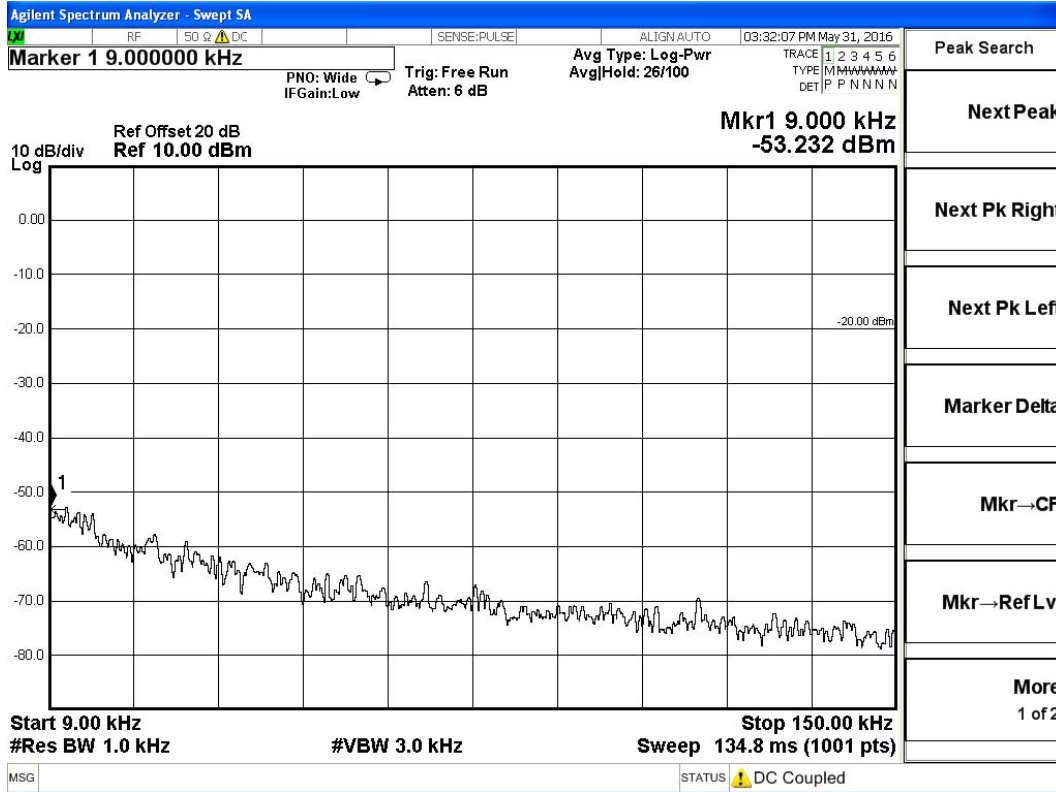

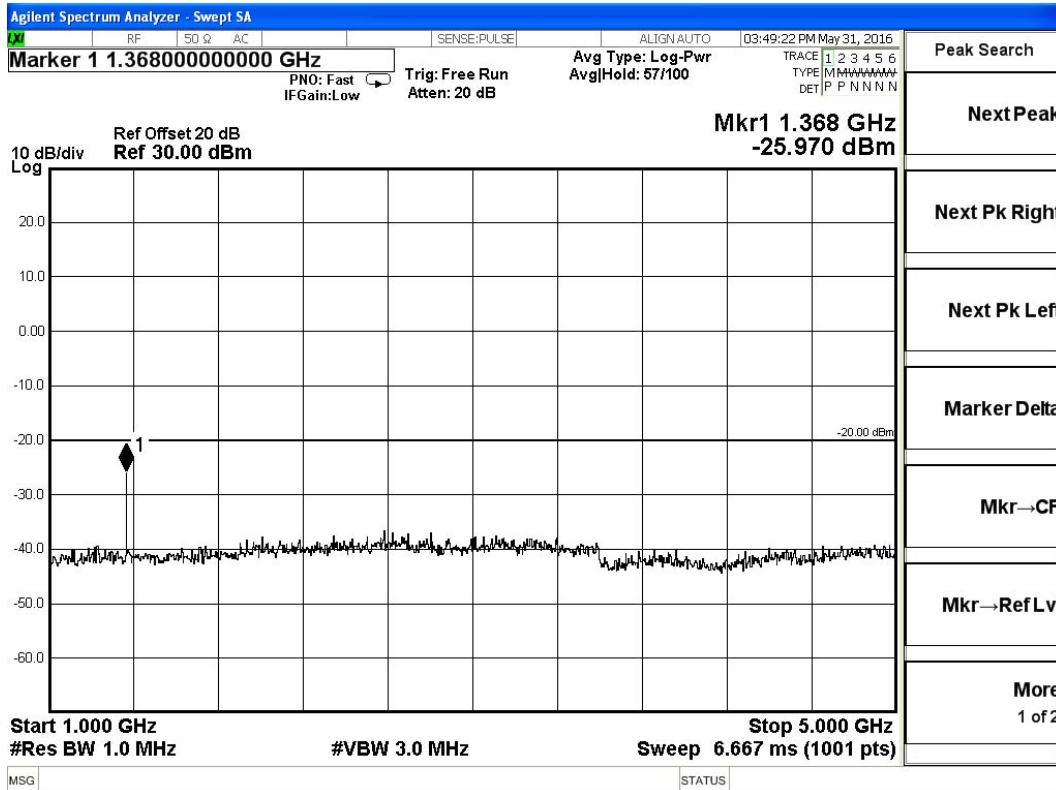
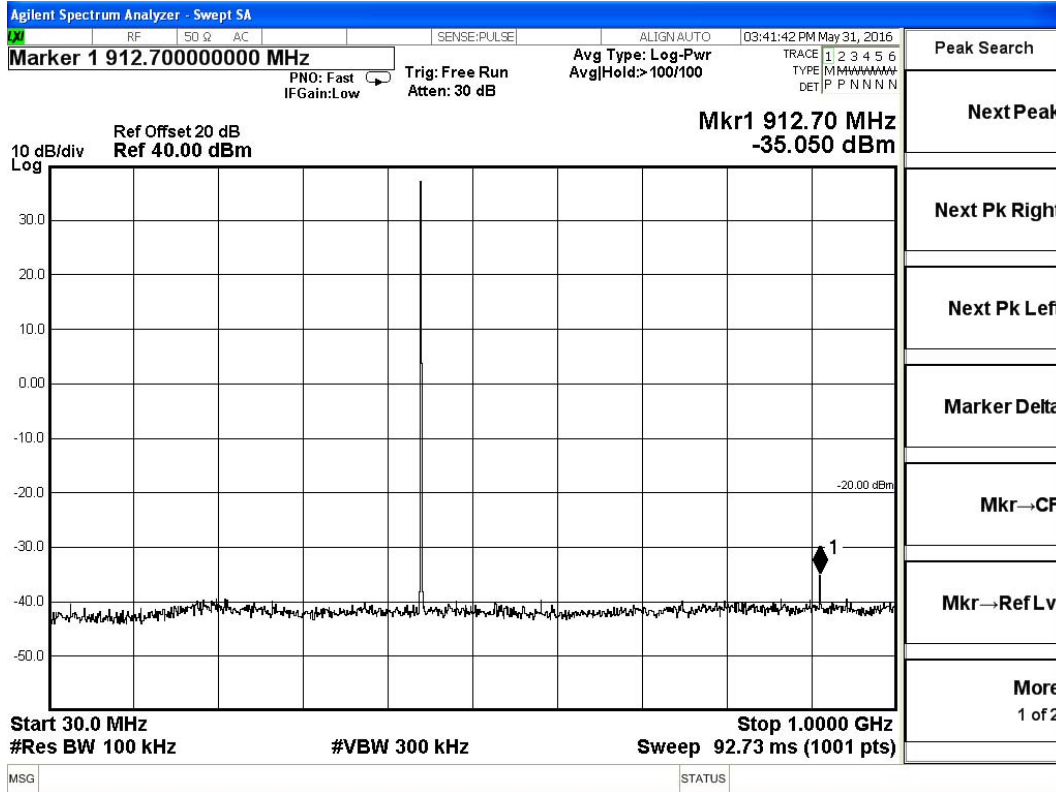

Operation Mode	Test Channel	Test Frequency (MHz)	Maximum Conducted Spurious Emissions Below 1GHz		Maximum Conducted Spurious Emissions Above 1GHz		Limit (dBm)
			Frequency (MHz)	Data (dBm)	Frequency (MHz)	Data (dBm)	
Op 3	Ch6	469.975	939.86	-34.64	1412.00	-26.28	-20.00

