

Premium Hardware Solutions

2024

G*GRASS[®]
AUSTRIA

Hettich
GERMANY

EUROFIT[®]



INOXA
INDUSTRIE
ITALY

ma
co
ITALY

ellelupi
1954
ITALY

Naber
...inspired
GERMANY

HELMITIN
GERMANY

MitreBond
GERMANY

ambos
ITALY

Jowat
GERMANY

EIGE King Slide
ITALY

JC Furniture Hardware Corp.

Eurofit Hardware Inc.

Quincaillerie Euroline Inc.

www.EurojytCanada.com

EURO Inspiration **FIT** For All

G*GRASS®

**Hettich**

King Slide®

Naber®
...inspires!

 **HELMITIN**

INOXA
INDUSTRIE

MitreBond™

EUROFIT®

ma 
CO

 **ambos**

 **SIGE™**

Contents



Wire Baskets 1-1



Handles & Knobs 2-1



Hinges 3-1



Slides 4-1



Drawer Systems 5-1



Cabinet Legs 6-1

Screws



Fasteners

7-1

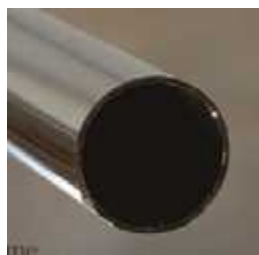

Closet & Storage 8-1



Waste Bin

9-1



Edging, Sealants
& Adhesives

10-1



General
Hardware

11-1



QR code for GRASS cataolgue



QR code for HETTICH cataolgue



You can tell the quality of a hinge system by how long a hinge will function without developing a fault and how much it will drop under load. Tiomos has achieved exceptionally positive values in tests for durability and for dropping under load.

Tiomos Hinge system

A masterpiece is usually the sum of small strokes of genius. Tiomos is the best example of this.

One of the outstanding characteristics of the hinge system is the Soft-close damper, which features stepwise adjustment and is fully concealed within the hinge arm. The complex inner workings of this high-tech hinge are hidden from view, much like a Swiss clock movement, and are sure to impress with their unique damping characteristics. The closing motion is even and seamless in each movement phase. And all this from an opening angle of just 20°. Irrespective of the size and weight of the door.

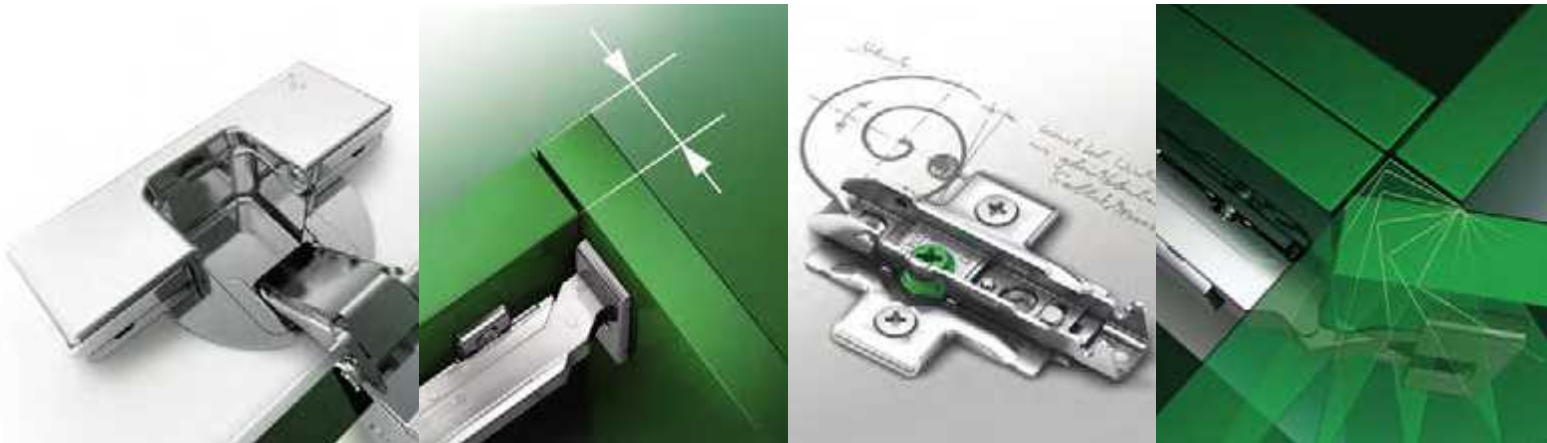

Every function has been completely redesigned and redeveloped from the bottom up.

Tiomos offers greater scope for creative design in furniture construction. The hinge system enables full-overlay doors up to 24 mm, ensures a stable connection thanks to the 30% larger contact area, and provides a matching design for combinations of hinges with and without Soft-close. In addition to damping, Tiomos hinges can also be optionally fitted with a self-opening mechanism.

Perfect alignment in an instant.

The Tiomos hinge system offers three movement dimensions for fine adjustment: Stepless, self-locking depth adjustment by +3 to -2 mm using a worm screw. The height can be adjusted by +/-2 mm. The overlay adjustment is +/-2 mm with limit stop.

Another stroke of genius is the new kinematics inside Tiomos.

Physically optimised lever movements make furniture doors extremely easy to open. In addition, the unique kinematics enable unprecedented alignments with minimal gap widths. These special features of the new hinge system are particularly beneficial for furniture designers, as the reduced gaps and reveals open up completely new possibilities in furniture design.



reddot design award
honourable mention 2010

Hinge systems for trade

GRASS hinge systems offer the perfect movement solution for almost any application.

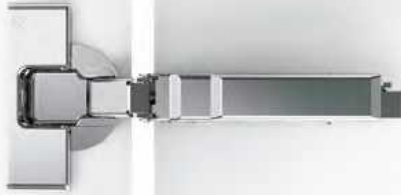

Tiomos

The overall aspiration of the range leaves nothing to be desired. Tiomos hinge system for all standard and special applications.



Tiomos M series

The comfortable hinge generation for greater freedom in design. For mirrored doors, glass doors, thin doors and much more.



Tiomos Hidden

The concealed hinge system for sophisticated furniture design. Available for wood and aluminium frame doors.



Nexis

The versatile hinge system. Finely tuned movement systems. Functionality meets high operating comfort.



Single-pivot hinges

Wide-opening solid metal hinges for individual or continuous cabinet construction. Space-saving. Flexible. Functional.



Flap hinge

The functional movement solution integrates beautifully into elegant furniture with drinks compartment flaps.

High load capacity. Synchronised movement. 4D adjustment. The large variety of special qualities makes Dynapro a unique movement system for those with individual style.

Dynapro Slide system

Whether wood, aluminium, glass, natural stone or concrete, let Dynapro provide the inspiration for new ideas.

Innovating means adopting new approaches. That applies just as much to the creation of new furniture designs as it does to the development of new movement systems. The more unique the design, the more vital it becomes to have intelligent function characteristics. To cater for even the most exceptional requirements, GRASS has developed a completely new slide system that combines concealed functionality and outstanding running characteristics. For furniture designers, this opens up entirely new perspectives.



Synchronisation for excellent running characteristics.

Unlike conventional concealed slide systems, Dynapro features a synchronisation mechanism. Even under high load, the excellent running characteristics of Dynapro remain unchanged. Load capacities of up to 70 kg are no problem for the system. Abrasion-resistant plastic rollers ensure a smooth, even glide every time.

Four dimensions for perfect alignment.

Dynapro offers integrated height adjustment, side adjustment, tilt angle adjustment and depth adjustment. All adjustments are tool-free, readily accessible and easy to make. In short, it takes just a few tweaks to achieve optimal alignment.

Four options for greater operating comfort.

The successful Soft-close damping system closes Dynapro drawers gently and quietly. The Tipmatic mechanical opening system allows handle-free fronts that can be opened with a gentle tap. The new Tipmatic Soft-close opening system combines all the advantages of mechanical opening with the comfort of the proven Soft-close damping. In addition, GRASS is rounding off its range with Sensomatic – the electronically assisted opening system.







reddot design award
winner 2010

Dynapro

Slide system

Synchronised full extension slide with four-dimensional adjustment facility with 40 kg and 70 kg load capacity. Slide-on assembly.

Product description	
	<p>Dynapro full extension slide 40/70 kg Soft-close</p> <ul style="list-style-type: none"> • Soft-close damping system • 4-dimensional adjustment (side, height, tilt angle and depth adjustment)
	<p>Dynapro full extension slide 40/70 kg Tipmatic Soft-close</p> <ul style="list-style-type: none"> • Tipmatic Soft-close opening system • 4-dimensional adjustment (side, height, tilt angle and depth adjustment)
	<p>Dynapro full extension slide 40/60 kg Tipmatic</p> <ul style="list-style-type: none"> • Tipmatic opening system • 4-dimensional adjustment (side, height, tilt angle and depth adjustment)
	<p>Dynapro for bottom panel mounting and pull-out shelf</p> <ul style="list-style-type: none"> • Assembly on the cabinet base or shelf • Shelf clip set
	<p>Application examples</p> <ul style="list-style-type: none"> • Dynapro Tipmatic Soft-close in double cabinet • Extra-wide drawer

Nova Pro Scala Drawer system

Nova Pro is the embodiment of exceptionally easy opening, excellent running characteristics, minimum drawer deflection and outstanding reliability. Nova Pro Scala means diversity, neutral aesthetics, inspiration and creativity.

A modular system requires standard features that can be combined. Nova Pro Scala therefore offers five standard heights. Starting at 63 mm for low available heights and up to 250 mm for special requirements. Supplemented by a rectangular railing and two glass variants, Nova Pro Scala is as versatile as our customers' furniture.



**Inset panel.
A statement look
hidden inside.**

Today we are seeing more and more high fronts with inset drawers hidden behind them. High fronts can make modern furniture look even more minimalist. Nova Pro Scala offers a truly beautiful solution for these special applications: elegant and extremely narrow inset panels with a shape and colour perfectly adapted to the drawer system.

**High-quality drawer sides.
The perfect combination
of form and function.**

A minimal installation width and the 90° inner sides of the slim Scala drawer sides provide up to 11% more storage space. The solid front connection guarantees a secure hold up to a front height of 780 mm. The proven Nova Pro slide ensures excellent running characteristics for load capacities up to 70 kg and the Soft-close technology ensures a smooth closing movement as well as effortless opening.

**Material variety.
The jury is out when it comes to glass.
Some love it and some hate it.**

Whether they choose to use glass or another design element depends entirely on the individual's taste. The special advantage of the Crystal Plus frame drawer is the newly developed clip technology. It ensures the safe and stable tensioning of large design elements without the need to pretreat them in any way.



Individual styling.

The flush designer panels make Scala the most customisable drawer system of its time.

With Nova Pro Scala, all visible plastic parts are coated in steel, eliminating any potential colour variation between individual components. This results in a consistent, even colour finish.

Modern designs are characterised by metallic colours, fine textures and a matt finish.

SILVER

In the Silver colour option, this design principle is continued inside the furniture.

ICE

Our inspiration for the Ice colour comes from the natural reflection of light and the finely textured finish.

STONE

The timelessness of stone is what gives the Stone colour its name.

Nova Pro Scala

Simple. Clear.
Timeless.



NP

Trusted, stable and consistent in design. The high-front drawer has been a classic for quite some time when it comes to reaching new heights. And thanks to the elegant design lines, the drawer can be adapted perfectly to the furniture as desired.



GERMAN
DESIGN
AWARD
WINNER
2016

Vionaro combines Dynapro with consummate design in an extremely slim drawer side.

A smart solution. Vionaro features the best of Dynapro. A slide for wooden and Vionaro drawers. With Dynapro, the proven concealed slide from GRASS, Vionaro uses the same basis as previous wooden drawers – fully synchronised for optimal running characteristics, high stability and load capacities of up to 70 kg.

Every year the Red Dot Award for Product Design recognises the world's best products. Vionaro is one of them.













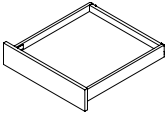

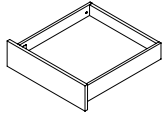

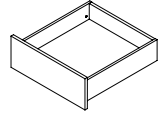

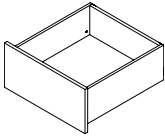
reddot award
winner 2014

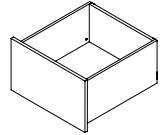

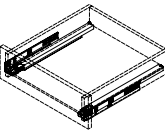
Vionaro

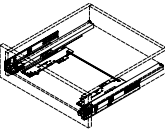
Drawer system

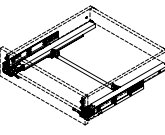
The ideal shape is simple and clear:
Vionaro – the slim design classic of tomorrow.

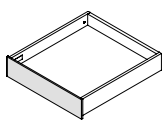
	Product description	
	Drawer H63 <ul style="list-style-type: none"> Extremely shallow drawer to accommodate low available height 4-dimensional adjustment (side, height, tilt angle and depth adjustment) 90° straight inner and outer sides Slim 13 mm drawer side width 	
	Drawer H89 <ul style="list-style-type: none"> The practical standard drawer for every application 4-dimensional adjustment (side, height, tilt angle and depth adjustment) 90° straight inner and outer sides Slim 13 mm drawer side width 	
	Drawer H121 <ul style="list-style-type: none"> The elegant intermediate height for special applications 4-dimensional adjustment (side, height, tilt angle and depth adjustment) 90° straight inner and outer sides Slim 13 mm drawer side width 	
	Pot drawer H185 <ul style="list-style-type: none"> Slim, closed drawer side 4-dimensional adjustment (side, height, tilt angle and depth adjustment) 90° straight inner and outer sides Slim 13 mm drawer side width 	
	Pot drawer H249 <ul style="list-style-type: none"> Slim, closed drawer side 4-dimensional adjustment (side, height, tilt angle and depth adjustment) 90° straight inner and outer sides Slim 13 mm drawer side width 	
	Dynapro full extension slide 40/70 kg Soft-close <ul style="list-style-type: none"> Synchronised full extension slide Soft-close damping system Excellent running characteristics 	
	Dynapro full extension slide 40/70 kg Tipmatic Soft-close <ul style="list-style-type: none"> Synchronised full extension slide Combines Tipmatic function with Soft-close damper Excellent running characteristics 	
	Dynapro full extension slide 40/60 kg Tipmatic <ul style="list-style-type: none"> Full extension slide Tipmatic Tipmatic element integrated into the slide Excellent running characteristics 	
	Inset panels <ul style="list-style-type: none"> Colour coordinated with Vionaro Elegant design Available in heights H89, H121 and H185 	

A pull is all it takes to set the flaps gently in motion. The front then appears to float upwards, almost as if it were weightless. The closing motion is also particularly comfortable. With the integrated Soft-close damping system, each movement becomes an experience.

Kinvaro Flap systems

Whichever flap you open, Kinvaro flap systems ensure perfect access and maximum freedom of movement.

There are no limits. Unless, of course, you choose to set them. Wall cabinets still rank among the most popular storage solutions for kitchens. And our highly functional flap systems ensure that this does not change. Stable and reliable movement systems that are smooth and silent, ergonomically well designed and easy to operate – these are the special ingredients for contemporary storage space concepts. Kinvaro flap systems therefore embody the optimum synthesis of design ambition and functional movement in the spirit of modern furniture culture.



Kinvaro F
Folding flap system

The two-part front folds upwards to provide optimum access to the entire storage space. The particularly smooth movement sequence is complemented by the integrated, adjustable Soft-close damping system.



Kinvaro L
Parallel lift flap system

The single-piece front opens parallel to the cabinet and remains fixed in any position. Parallel lift flap systems move very elegantly, are extremely strong and are particularly suitable for cupboards with kitchen appliances.



Kinvaro S
Up-and-over flap system

The single-piece front lifts up above the cabinet at an angle and remains fixed in any position. Up-and-over flap systems are extremely stable and particularly well suited to cabinets with cornices, pelmet and attached lights.

Kinvaro T-Slim has received two of the world's most prestigious design awards.











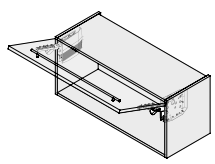

GERMAN
DESIGN
AWARD
SPECIAL
2021

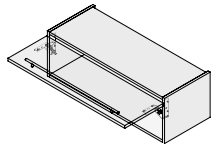

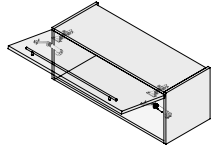
reddot winner 2020

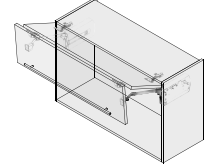
Kinvaro

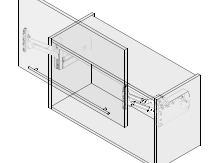

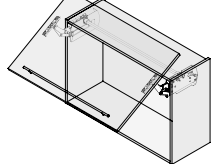







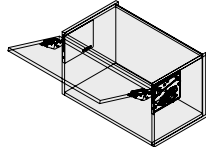

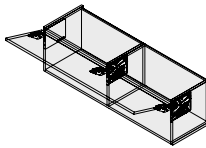
Flap systems

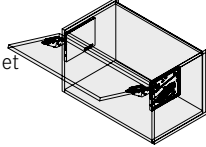
	Product description	
	<p>Kinvaro T-76 lift-up flap fitting</p> <ul style="list-style-type: none"> • Variable opening angle – holds flap securely at any angle between 45° and 110° • Extremely comfortable opening thanks to spring-supported opening mechanism • Adjustable spring force • Integrated adjustable closing damper • Allows additional cabinet installation above 	
	<p>Kinvaro T-57 lift-up flap fitting</p> <ul style="list-style-type: none"> • Opening angle adjustable to 75° or 90° • Easy to install • Adjustable spring force • Allows additional cabinet installation above 	
	<p>Kinvaro T-105 flap stay</p> <ul style="list-style-type: none"> • Variable opening angle – holds flap securely at any angle between 45° and 105° • Spring-supported opening function • Adjustable spring force • Convenient access, flap lifts clear of the work area • Allows additional cabinet installation above 	
	<p>Kinvaro F-20 folding flap fitting</p> <ul style="list-style-type: none"> • Holds flap securely in any position • Extremely smooth movement • Adjustable spring force • Integrated adjustable closing damper 	
	<p>Kinvaro L-80 parallel lift flap fitting</p> <ul style="list-style-type: none"> • Holds flap securely in any position • Extremely smooth movement • Adjustable spring force • Integrated adjustable closing damper • Allows the use of corners, pellets and pellet lights 	
	<p>Kinvaro S-35 up-and-over flap fitting</p> <ul style="list-style-type: none"> • Securely holds flap in any position from 45° opening angle • Extremely smooth movement • Adjustable spring force • Integrated adjustable closing damper • Allows the use of corners, pellets and pellet lights 	

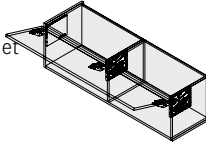
Kinvaro

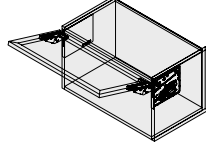
Flap systems

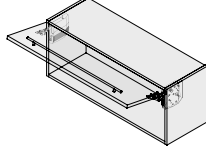
Exclusive flap systems for the highest demands in design, technology and operating comfort.

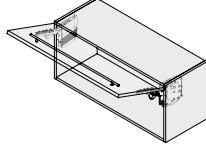
	Product description	
	<p>Kinvaro T-Slim lift-up flap fitting for wooden fronts (inset)</p> <ul style="list-style-type: none"> • Flush inset flap fitting for high design requirements and maximum storage space • Inset depth: cabinet side: 12.2 mm, front: 13.7 mm • Low opening forces and multi-position stop • Convenient adjustment of the spring force 	
	<p>Kinvaro T-Slim lift-up flap fitting for wide wooden fronts (inset)</p> <ul style="list-style-type: none"> • Flush inset flap fitting for high design requirements and maximum storage space • Additional fitting for wide fronts • Inset depth: cabinet side: 12.2 mm, front: 13.7 mm • Low opening forces and multi-position stop • Convenient adjustment of the spring force 	
	<p>Kinvaro T-Slim lift-up flap fitting for wooden fronts (screw-mounted)</p> <ul style="list-style-type: none"> • Slim flap fitting for high design requirements and more storage space in the wall cabinet • Low opening forces and multi-position stop • Convenient adjustment of the spring force 	
	<p>Kinvaro T-Slim lift-up flap fitting for wide wooden fronts (screw-mounted)</p> <ul style="list-style-type: none"> • Slim flap fitting for high design requirements and more storage space in the wall cabinet • Additional fitting for wide fronts • Low opening forces and multi-position stop • Convenient adjustment of the spring force 	
	<p>Kinvaro T-Slim lift-up flap fitting for aluminium-framed fronts (inset)</p> <ul style="list-style-type: none"> • Flush inset flap fitting for high design requirements and maximum storage space • Front connection for combination with aluminium frame • Inset depth: cabinet side: 12.2 mm • Low opening forces and multi-position stop 	
	<p>Kinvaro T-65 lift-up flap fitting</p> <ul style="list-style-type: none"> • Variable opening angle – holds flap securely at any angle between 45° and 100° • Extremely comfortable opening thanks to spring-supported opening mechanism • Adjustable spring force • Integrated adjustable closing damper • Allows additional cabinet installation above 	
	<p>Kinvaro T-71 lift-up flap fitting</p> <ul style="list-style-type: none"> • Variable opening angle – holds flap securely at any angle between 45° and 110° • Extremely comfortable opening thanks to spring-supported opening mechanism • Adjustable spring force • Integrated adjustable closing damper • Allows additional cabinet installation above 	

**A powerful
trio for greater
versatility.**



Kinvaro T-Slim flap system.

Wide fronts are as popular as ever. Their advantages are particularly clear when used in wall cabinets. Wide fronts not only eliminate gaps, but when opened they reveal plenty of storage space. There is no question that Kinvaro T-Slim also offers an intelligent solution for wide fronts. An additional flap fitting is added for cabinet widths greater than 1200 mm. This creates a powerful trio that increases the load capacity by 50%.

The ideal storage space is horizontal.

Horizontal storage spaces with lift-up flaps at eye level to make them easily accessible and particularly practical.

Directly above the worktop in the kitchen, over the sink or hob. Above the bathroom sink or next to the mirror. Above a desk or TV in the living area. In modern interior design, flap cabinets have firmly established themselves as horizontal design elements. Whereas high wall units with high flap fronts used to be the norm, designers today are increasingly returning to horizontal formats. Kinvaro T-Slim is the ideal solution.



Kinvaro D

Drinks compartment flap

The slim flap system with pull cable integrates beautifully into elegant furniture with drinks compartment flaps.

Product description		
	<p>Kinvaro D-M flap stay with pull cable</p> <ul style="list-style-type: none"> • Damped opening and gentle closing • Opening angle adjustable via length of pull cable • Spring force adjustment • Can be used with shallow cabinets from 110 mm depth • Flap height 200-480 mm 	
	<p>Kinvaro D-S flap stay with pull cable</p> <ul style="list-style-type: none"> • Damped opening • Opening angle adjustable via length of pull cable • Can be used with shallow cabinets from 82 mm depth • Flap height 200-480 mm 	
	<p>Tiomos flap hinges for flap thicknesses from 14 to 21 mm</p> <ul style="list-style-type: none"> • Cup hole 35 mm • 3-dimensional adjustment 	
	<p>Tiomos flap hinges for flap thicknesses from 22 to 30 mm</p> <ul style="list-style-type: none"> • Cup hole 35 mm • 3-dimensional adjustment 	

Dividing and organising systems

Our dividing and organising systems are designed to ensure the neat and tidy arrangement of drawer contents for everyday use in the kitchen.



Organisation for **Nova Pro**

Tavinea Sorto interior accessory system with a wide choice of elements and various drawer dividers as well as the Tavinea Optima dividing system for pot drawers.



Organisation for **Vionario**

The Vionario design drawer is perfectly complemented by the slim frame elements of Tavinea Sorto and Tavinea Optima for pot drawers.



Furniture Fittings and Applications

Plan. Realise. Fascinate.



Technik für Möbel

Hettich

Fast assembly concealed hinge

- ▶ Sensys with integrated Silent System
- ▶ Intermat hinge



Sensys



Sensys in obsidian black



Sensys for glass applications



Mounting plates
For Sensys and Intermat



Accessories



Opening system for handleless furniture fronts
Push to open Silent for hinged doors
Push to open for hinges



Intermat hinge



Assembly aids
For Push to open drill in versions

Actro 5D drawer runners



Quadro 4D V6 drawer runners



KA ball bearing runners Silent System



Push to open Silent for Quadro 4D V6 / Actro 5D



AvanTech YOU double walled drawer system

► Powder coated steel, white and anthracite



Narrow base unit



Tall unit



Pantry unit



Interior organisation



For use of space under the sink



Metal surround for U bend cutout - square



Metal surround for U bend cutout - round



OrgaTray 510 for under the sink



Empty double-walled drawer

AvanTech YOU double walled drawer system

► Powder coated steel, white and anthracite



Drawer, height 77 mm



Drawer, height 101 mm



Drawer, height 139 mm



Drawer, height 187 mm



Drawer, height 251 mm



Inlay drawer, height 187 mm



Rear panels



Internal drawer, height 101 / 139 / 187 mm



Design options



Other accessories



Actro YOU / Quadro YOU drawer runners



Push to open Silent

Fitting systems for kitchens

- ▶ Waste collecting systems
- ▶ Laundry System, drawer interior organizer



Waste collecting systems behind front panels



Waste collecting systems behind hinged doors

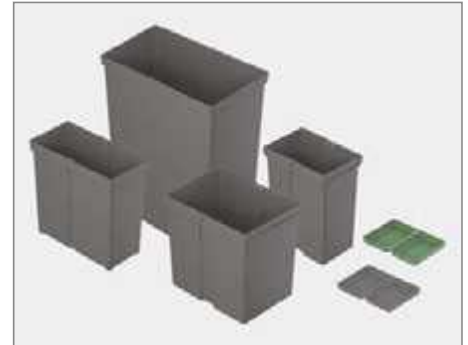

Replacement bin / lid



Laundry baskets Pull Out System



OrgaTray Organizer



InnoTech Atira Knife holder

Folding door system

▶ Wing 77 / freely moveable



Fantastic flexibility
With Wing 77, you can produce cabinet fronts with two door wings (no more than 25 kg each) or four door wings (no more than 20 kg each). The clever part: the entire door set is free moving! Door sets can also be interlinked. Surprise your customers with individually tailored folding door solutions for the bedroom or office. Wing 77 gives you the design flexibility to do so.



Leaves a good impression:
Design flexibility with up to 4 door wings. No mounting to cabinet body side.



Tried and proven:
Sturdy runner profile on the top panel as well as bottom guide.



hettich.com/short/a5e4fd



Find out more:
You can get inspiration and further product details on our website.

Folding door system

▶ WingLine 230 / attached to the side



For mammoth tasks WingLine 230 is the giant among folding door systems: areas of over 6 m² are opened up in a single movement. Perfect for large cabinets, e.g. in the office or utility room. As an agile room divider. Or for a walk in cabinet in living areas that can be opened and closed with a turn of the hand. WingLine 230 has exactly what it takes, supporting doors with a wing weight of 20 to 25 kg. Extremely sturdy: side mounting with Sensys 8645i fast assembly concealed hinge. WingLine 230 requires neither centre panels nor any bottom guide.



hettich.com/short/06f7bd

The all rounder:
For general-purpose use - as cabinet door and as room divider.

Goodbye tripping hazard:
Even large, heavy doors manage without any bottom guide.

Find out more:
You can get inspiration and further product details on our website.

Retractable door system

► KA 5740



Stroke of genius

Mounted on the KA 5740 retractable door fitting, the doors also vanishes from view: simply by using face frame hinges. can slide back into the sides of the cabinet body when they are opened. Perfect, for example, for TV and multimedia furniture or for a cocktail cabinet that opens up in a jiffy and disappears again just as quickly. The fitting's mechanism

Hettich retractable door fitting KA 5740 is suitable for door widths of 300 to 700 mm. All options with roll-out prevention.



Furniture versatility:
All contents revealed and neat, tidy organisation in an instant.



Creating space:
The KA 5740 makes the doors vanish completely in the cabinet body after opening them.



Hidden working parts:
Large domestic appliances can be hidden from view behind the pocket doors.



hettich.com/short/684bd6

Find out more:
You can get inspiration and further product details on our website.

Sliding door system for overlay door position

► SlideLine M / bottom running



Design upgrade for furniture

SlideLine M upgrades the practical value and design of furniture. Living room storage units and shelf systems, kitchen wall units as well as bathroom furniture and office cabinets. The versatile system is suitable for all common furniture constructions with wooden, glass or aluminium

frame doors. Profiles are available for several shelf thicknesses. The Silent System is integrated on the running component and slows down door running action in closing, opening and colliding direction.



Including a feel of luxury: Silent System in closing, opening and colliding direction.



Tool-less fast installation: Sliding doors easy to install.



Spot on: Integrated height adjustment for perfectly aligned doors.



Fast and easy: Profiles are simple screw mounted to the assembled cabinet body.



Create furniture with a focus on design: Stick on decorative tapes in three colours add a finishing touch to the runner profile.



Design in motion: SlideLine M provides customised design options.

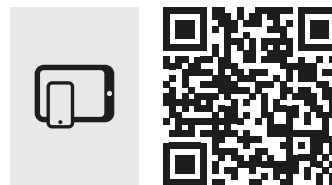

hettich.com/short/b56580

Find out more: You can get inspiration and further product details on our website.



Height adjustable leg

- ▶ Euro
- ▶ Plinth foot, adapter, fixing block



Euro plinth foot

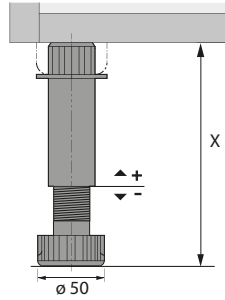

- ▶ Fitting system comprising height adjustable legs, fixing blocks and other accessories
- ▶ Load capacity 450 kg / leg, maximum of 1350 kg for 3 or more legs
- ▶ Leg is securely held in the fixing block, simple height adjustment
- ▶ Plinth drawers can be fitted from a plinth height of 150 mm
- ▶ Plastic, black

Plinth height dimension X mm	Adjustment range mm	Order no.	PU
100	95 - 123	9 028 440	200 ea.
110	95 - 133	9 057 432	200 ea.
120	115 - 153	9 054 540	200 ea.
150	135 - 163	9 054 501	100 ea.

Adapter for plinth foot

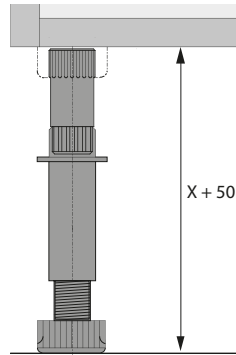

- ▶ For extending the plinth foot by 50 mm
- ▶ Plastic, black

Order no.	PU
9 021 887	250 ea.

Fixing block, for screwing on

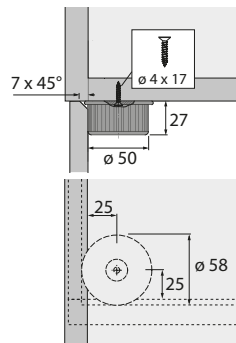

- ▶ With surface to support side panel
- ▶ Plastic, black

Order no.	PU
9 031 092	500 ea.

Fixing block, for knock-in

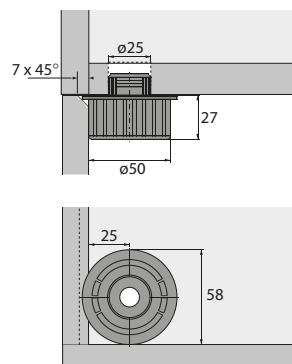

- ▶ For 25 mm hole diameter
- ▶ Plastic, black

Order no.	PU
9 031 091	500 ea.



Rastex 12, Rastex 15 and Rastex 25 eccentric connecting fitting
Can be used in conjunction with fast installation dowels
and screw in dowels
Summary



VB 35 / VB 35 M eccentric connecting fitting
with angled eccentric connection
Can be used in conjunction with steel dowels



VB 36 M eccentric connecting fitting
with angled eccentric connection
Can be used in conjunction with steel dowels



VB 135
Tool-less shelf mounting to the cabinet body



TZ 4 STD
For connecting cabinet bodies, also suitable for solid wood



Cabinet suspension brackets and suspension rails



suspension bracket for use on the back of the rear panel.

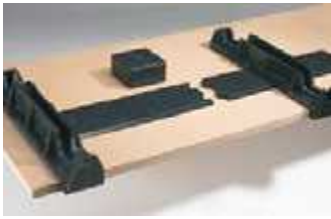

Assembly aids for drawers

- ▶ For AvanTech YOU, ArciTech and InnoTech Aтира



Drilling jigs

- ▶ For hinges and mounting plates
- ▶ For runners, connecting fittings and handles



Drilling jigs for front / rear panel fixing

- ▶ For AvanTech YOU, ArciTech and InnoTech Aтира



Drilling jigs for mounting hinges



Drilling jigs for installing connecting fittings and flap fittings

- ▶ For VB 35, VB 36, VB 135, Rastex and Everfix



Drilling jigs for installing runners, handles and knobs

- ▶ For Quadro drawer runners on wooden drawers, Actro 5D and Actro YOU / Quadro YOU wooden drawers



Tooling for knocking in drawers and drilling jigs for slide on installation

- ▶ For AvanTech YOU and ArciTech
- ▶ For SlideLine 55 Plus



Drilling jig cabinet body

- ▶ for runners

Drilling jigs

- ▶ Accura
- ▶ For hinges, mounting plates, runners and handles

Accura drilling jig

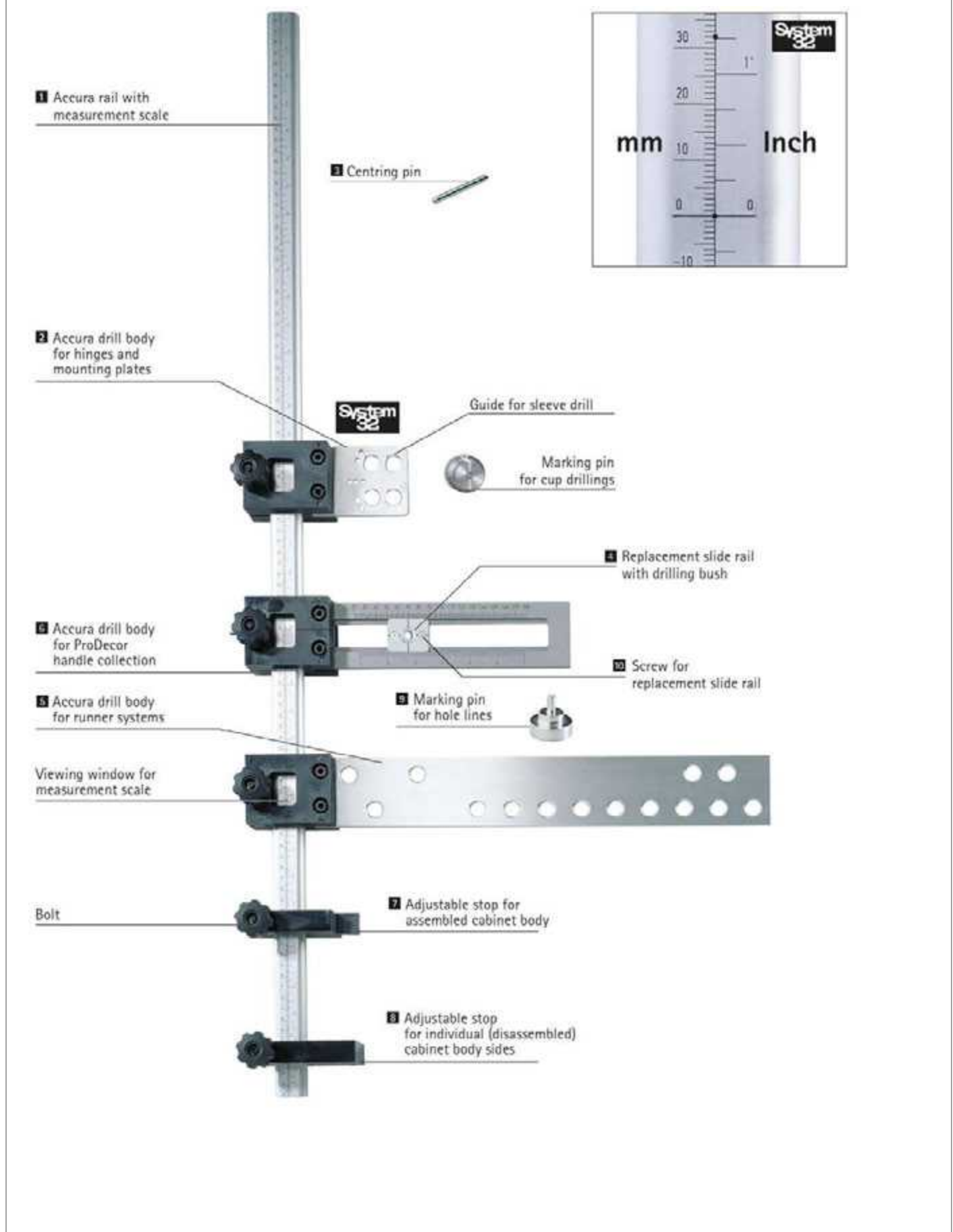

BlueMax Mini

► Type 3 including hold down clamp and press in frame



BlueMax Mini, type 3

Compact automatic drilling and insertion machine

- Pneumatic stroke
- Drilling unit with 6 drilling spindles
- Fence with work bench
- Hold-down clamp
- Swivel unit
- 220 V / 60 Hz / 1-phase Motor power rating 1.6kW (2.15 HP)
- 2 pendulum stops
- Please order drill bits separately
- Hinge insertion die

Article	Drilling pattern for hinge cup	Order no.	PU
220 V / 60 Hz / 1-phase / 1.6 kW (2.15 HP)	TH 52 x 5.5 mm	0 047 955	1 ea.
220 V / 60 Hz / 1-phase / 1.6 kW (2.15 HP)	TB 45 x 9.5 mm	0 047 956	1 ea.

Drilling pattern for hinge cup

► TH 52 x 5.5 mm

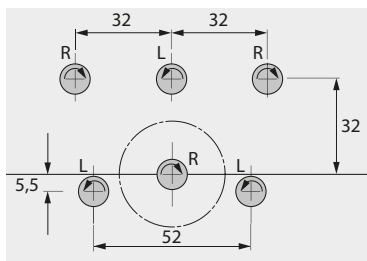

Drilling pattern for hinge cup

► TB 45 x 9.5 mm

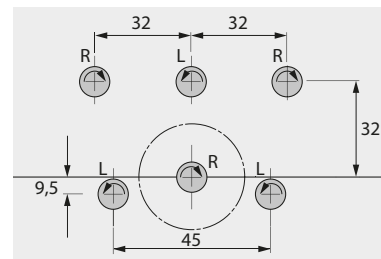

Wire Baskets



Made in ITALY

COMBI Peanut Shape Blind Corner

wire baskets



- * Quick Installation (5 Minutes)
- * Side Panel Installation
- * Each Tray Installed Independently
- * Melamine Trays
- * Soft Closing (Optional)
- White or graphite Finish (AR)

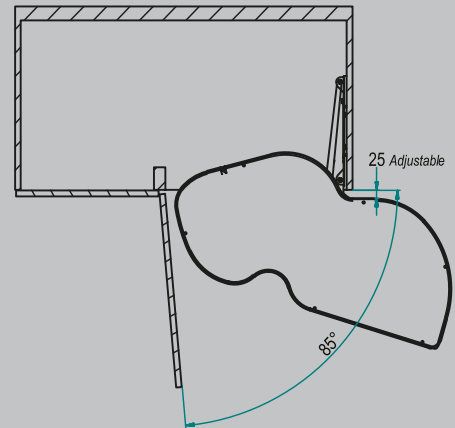

*All drawing measurement in minimeters(mm)

Adjustable Position To Avoid Touching Adjacent Handle

Closed

Open

Closed

Open

XLM-005L/845 LAR (Left-Hand Opening)

XLM-006R/846 RAR (Right-Hand Opening)

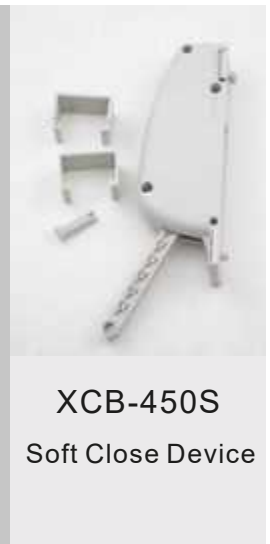

With Revolving Trays

Load Capacity: 20kg

Item No.	Feature	Min. Cab Depth (Interior)	Door Width (Interior)	Min. Cab Width (Interior)
XLM-005L/005LAR	Left	20"	21½"	34"
XLM-006R/006RAR	Right	20"	21½"	34"
XCB-845L/845LAR	Left	20"	16"	32"
XCB-846R/846RAR	Right	20"	16"	32"

Item No.	Description
XCB-450S	Soft close device for combis

Compact Blind Corner Solution



- * Soft Closing
- * Melamine Trays
- * White or Graphite Finish (AR)
- * Universal



wire baskets

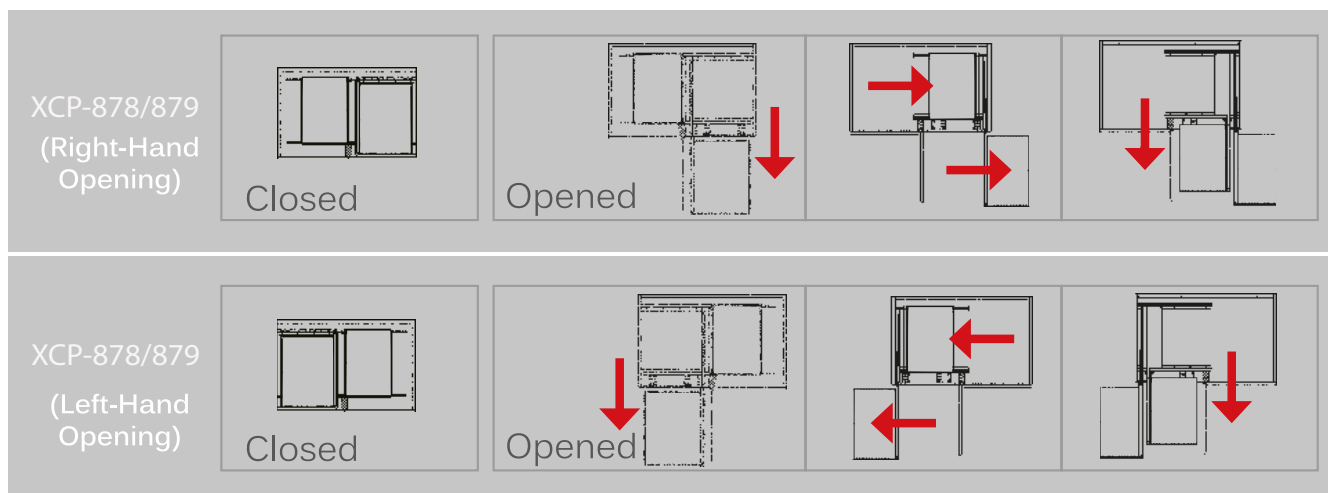

All Baskets Pull Out

Load Capacity: 40kg

Item No.	Height (Interior)	Min. Door Width (Interior)	Min. Cab. Depth (Interior)	Min. Width (Interior)
XCP-878	24"	15"	20"	28½"
XCP-878AR	24"	15"	20"	28½"
XCP-879	24"	21½"	20"	38½"

Dynamic Blind Corner Solution

wire baskets



Made In Italy

XMC-001L

- * Soft Closing
- * Melamine Trays
- * White or Graphite Finish (AR)

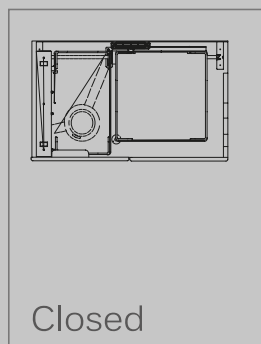
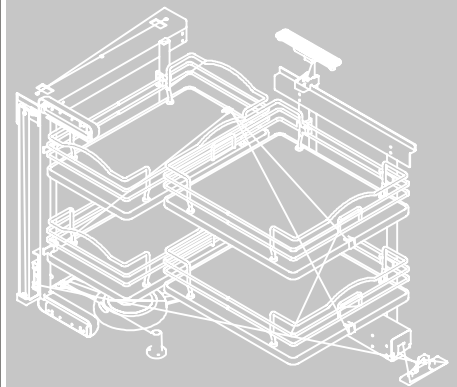

Closed

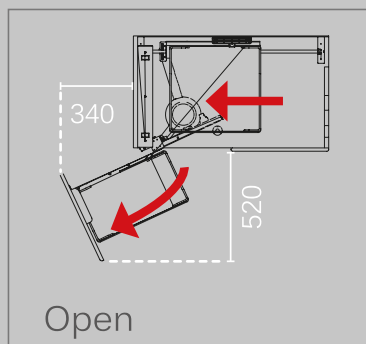

Open

XMC-001L/LAR (Left-Hand Opening)

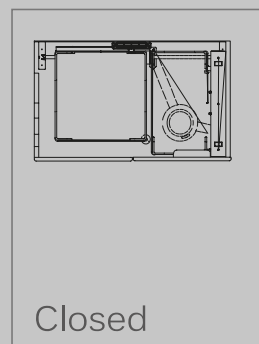

Closed

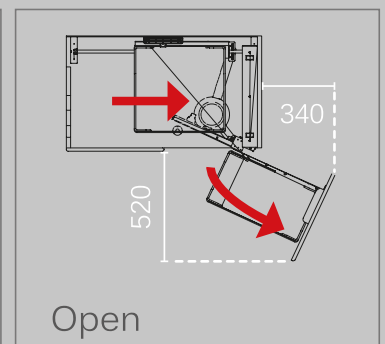

Open

XMC-002R/RAR (Right-Hand Opening)

*All drawing measurement in minimeters(mm)

Door Mounted

Load Capacity: 35kg

Item No.	Feature	Min. Depth (Interior)	Min. Door Width (Interior)	Min. Height (Interior)	Width (Interior)
XMC-002R/RAR	Right	20"	15"	26"	34½"
XMC-001L/LAR	Left	20"	15"	26"	34½"

Pie Cut Shape Lazy Susan (270°)



Made In Italy

- * Independently Rotating Trays
- * Melamine Trays
- * White or Graphite Finish (AR)
- * Height Adjustable
- * Soft Clip Positioning

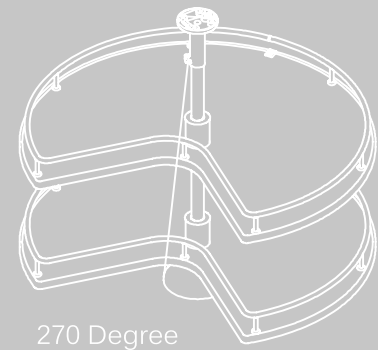

270 Degree

wire baskets

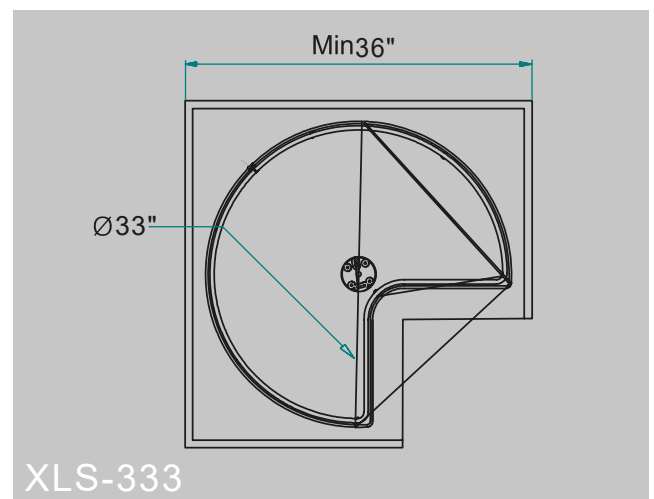
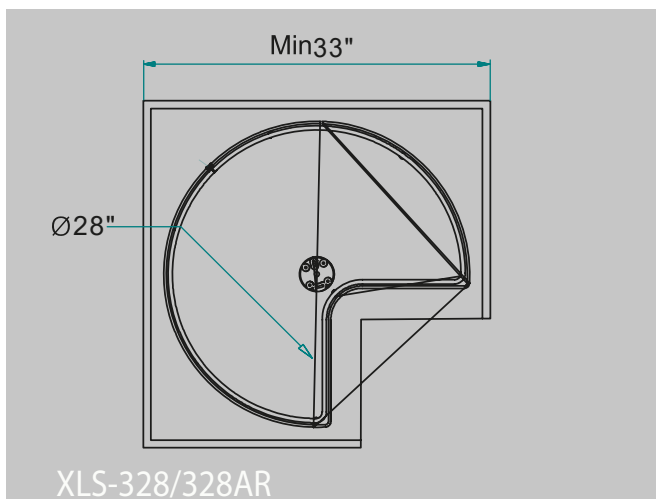

Load Capacity: 15kg Per Tray

Item No.	Basket Size	Min. Cabinet Width & Depth (Interior)
XLS-328/328AR	Ø28"	30"
XLS-333	Ø33"	35"

wire baskets

Full Round Lazy Susan



Made In Italy

- * *Independently Rotating Trays*
- * *Melamine Trays (White)*
- * *Height Adjustable*
- * *Soft Clip Positioning*

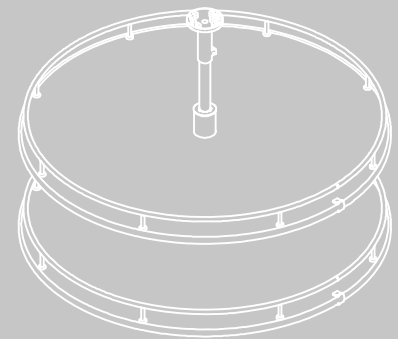

Full Round

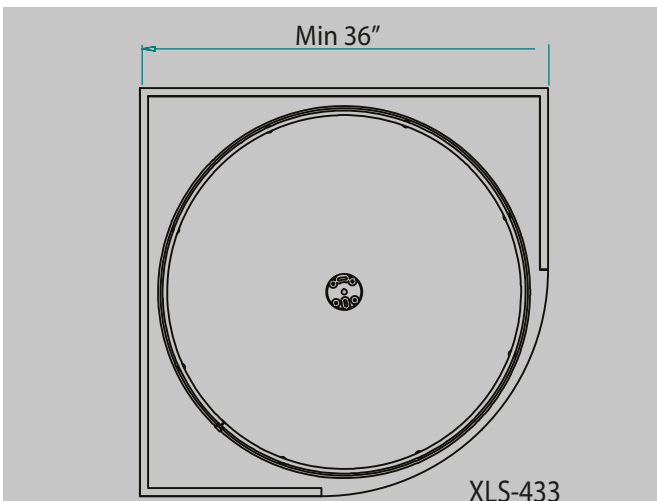

XLS-433

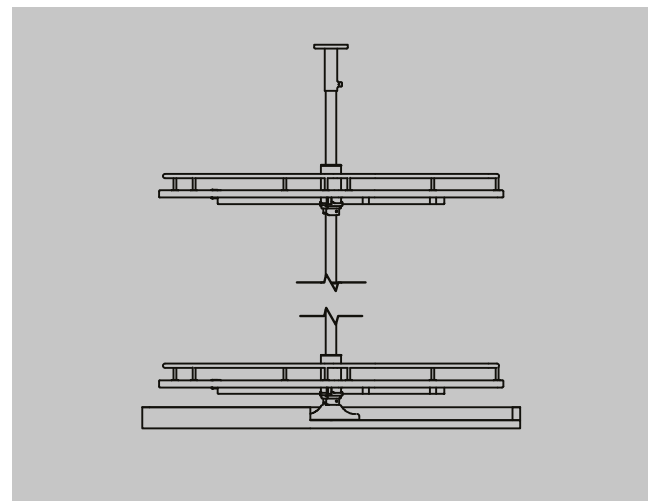

Load Capacity: 15kg Per Tray

Item No.	Basket Size	Min. Cabinet Width (Interior)
XLS-433	Ø33"	36"

Half Round Universal

wire baskets



- * *Independently Rotating Trays*
- * *Melamine Trays*
- * *Height Adjustable*
- * *Left / Right Interchangeable*

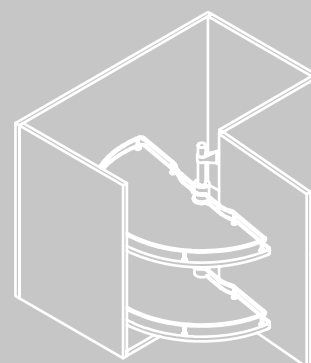

Made In Italy

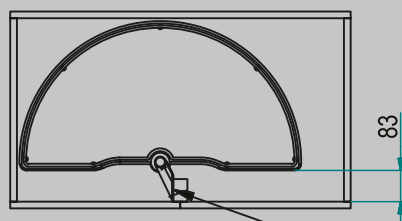

Assembly With Upright

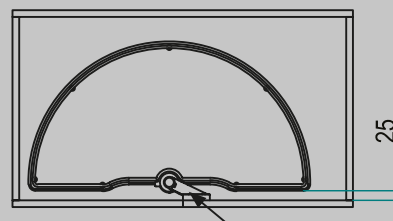

Assembly With Front Panel

*All drawing measurement in millimeters(mm)

180 Degree Lazy Susan

Load Capacity: 15kg

Item No.	Min. Door Width (Interior)	Min. Cabinet Depth (Interior)	Min. Cabinet Width (Interior)
XHR-233	16½"	20"	30"

Spice Racks With Door Mounted Brackets

- * Soft Closing
- * Melamine Trays
- * with GRASS Dynamic XP Slides

wire baskets

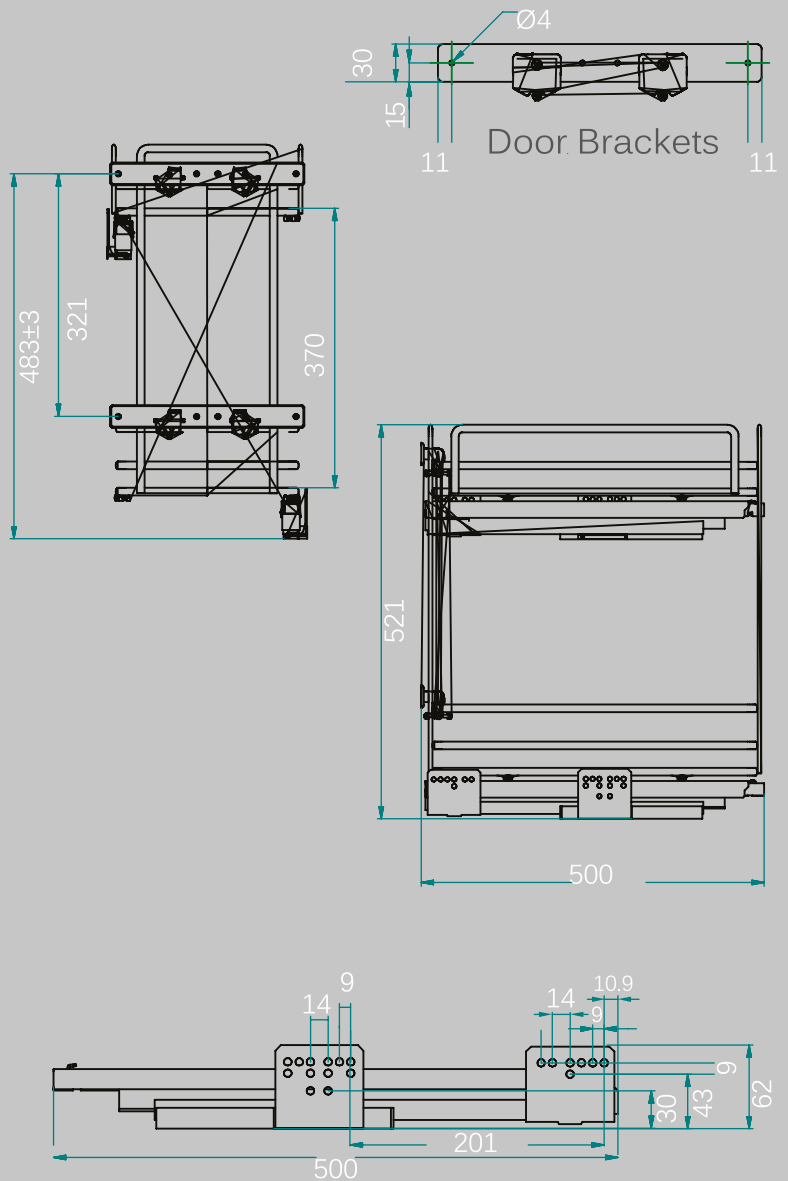

*All drawing measurement in minimeters(mm)

Load Capacity: 40Kg

Item No.	Cabinet Depth (Interior)	Height (Interior)	Min. Width (Interior)
XSR-300	20"	22"	10½"
XSR-400	20"	22"	14½"
XSR-450	20"	22"	16½"

Spice Racks With Door Mounted Brackets

- * Soft Closing
- * Melamine Trays
- * White or Graphite Finish (AR)
- * With GRASS Dynamic XP slides

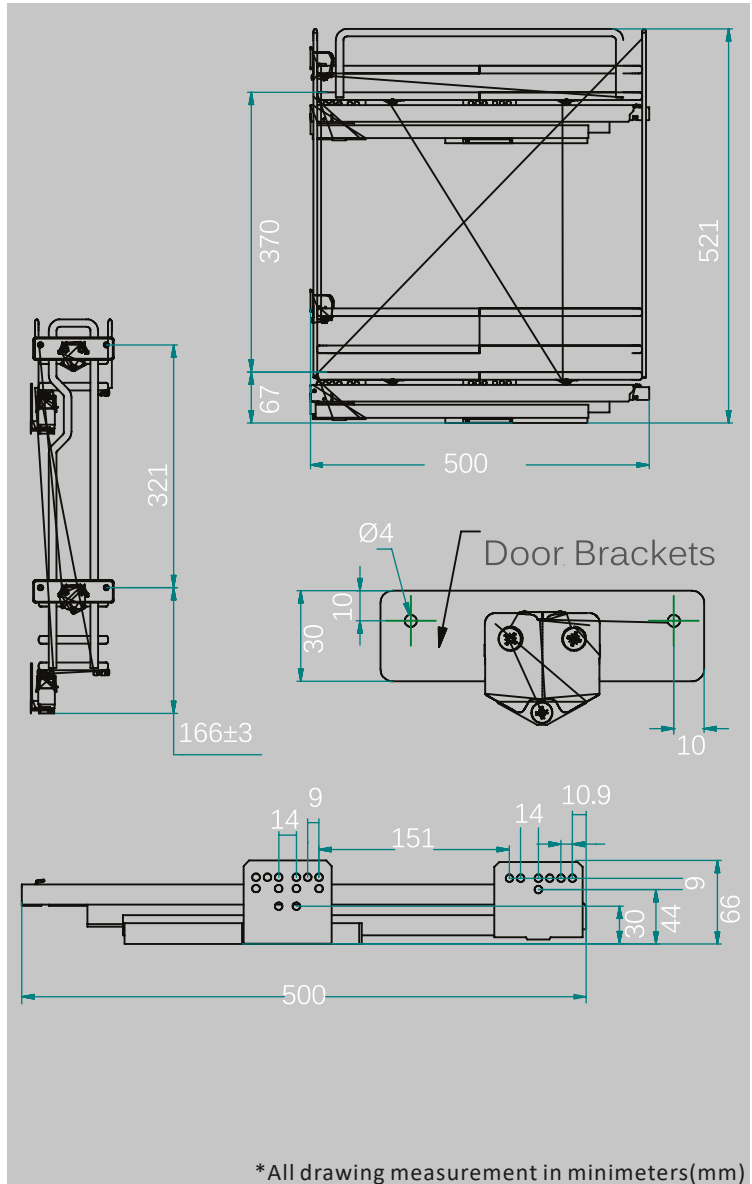

wire baskets

*All drawing measurement in minimeters(mm)

With GRASS Dynamic XP Slides

Load Capacity: 40Kg

Item No.	Feature	Cabinet Depth (Interior)	Height (Interior)	Min. Width (Interior)
XCR-150L/150LAR	Left	20"	22"	4½"
XCR-150R/150RAR	Right	20"	22"	4½"
XCR-200L/200LAR	Left	20"	22"	6½"
XCR-200R/200RAR	Right	20"	22"	6½"
XCR-250L/250LAR	Left	20"	22"	8½"
XCR-250R/250RAR	Right	20"	22"	8½"

Under Sink Rack

wire baskets

- *Soft Closing
- *Melamine Bottom
- *White or Graphite Finish (AR)
- *Two plastic trays in same finish
- *Plastic trays can be taken out
- *With GRASS Dynamic XP Slides

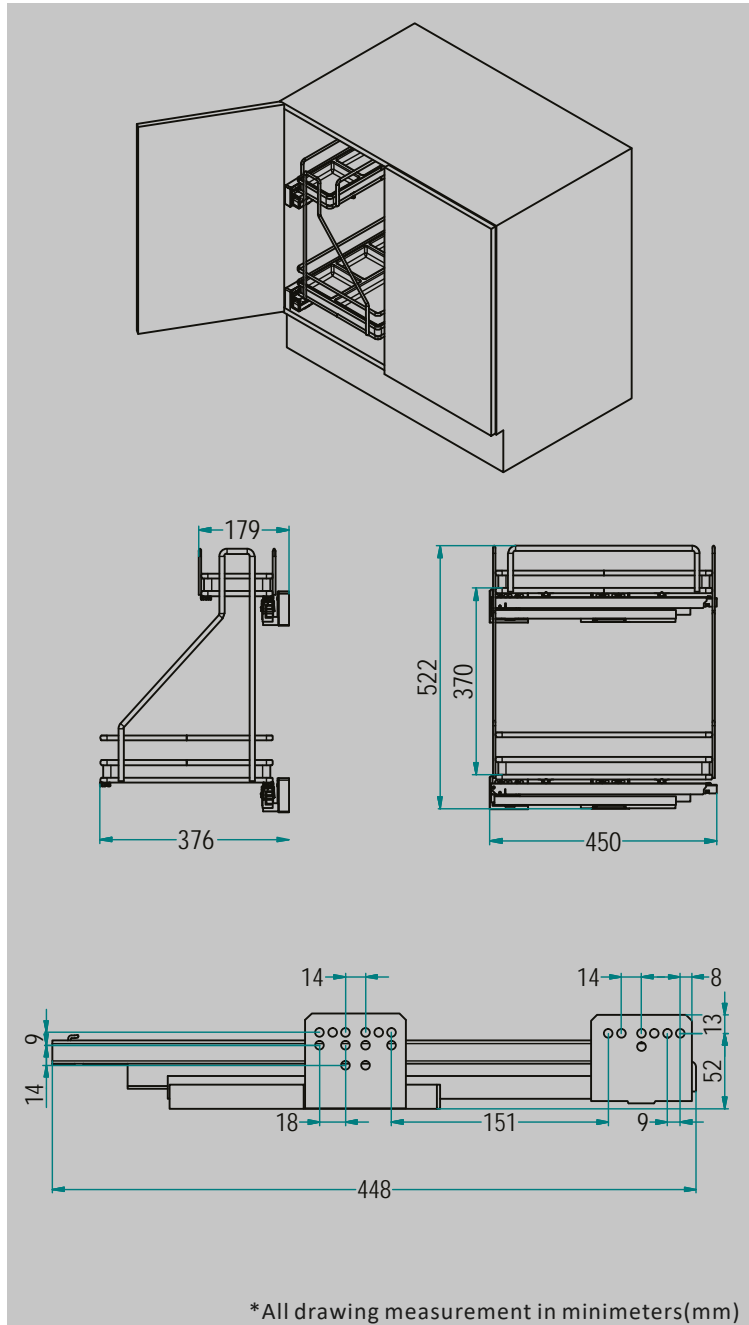

With GRASS Dynamic XP Slides

Load Capacity: 15kg

Item No.	Feature	Min Cabinet Depth (Interior)	Min. Width (Interior)
XDR-108R/108RAR	Right	20"	15"
XDR-108L/108LAR	Left	20"	15"

Pull Out Wire Basket (per drawer)



- *Soft Closing
- *Melamine tray (white)
- *Sold by per drawer
- *With GRASS Dynamic XP Slides

GRASS

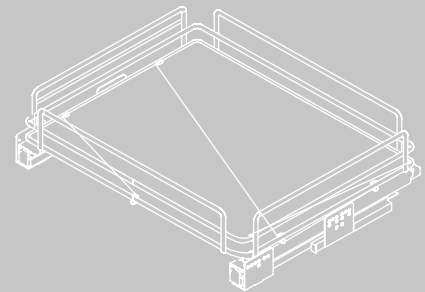

Made In Italy

Soft Closing

wire baskets

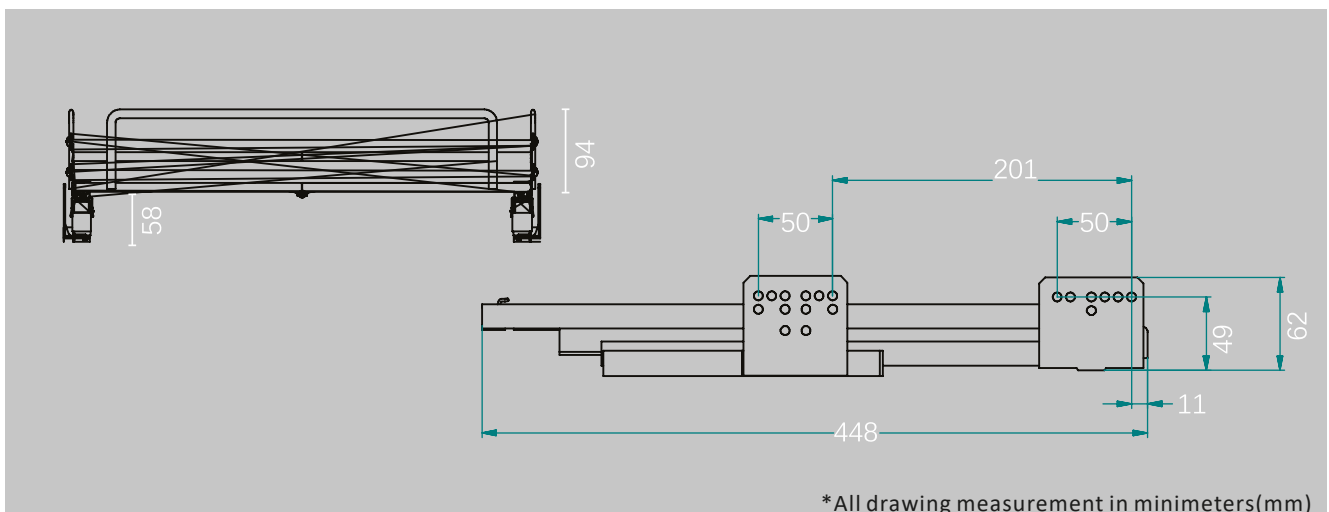

With GRASS Dynamic XP Slides

Load Capacity: 40kg

Item No.	Description	Min. Cabinet Depth (Interior)	Cabinet Width (Interior)	Height (Interior)
XPD-600	1 pull out basket	20½"	22⅞"	6½"
XPD-900	1 pull out basket	20½"	34⅞"	6½"

Wire Baskets



Made in ITALY

Draining Rack Set (2 Levels with 1 under bottom tray)



Load Capacity: 40kg

Item No.	Min. Cabinet Depth (Inner)	Min. Width (Inner)
XDR-600	11"	22 $\frac{1}{8}$ "
XDR-800	11"	30 $\frac{1}{8}$ "
XDR-900	11"	34 $\frac{1}{8}$ "

Pull Out Draining Rack (Door Mounted)

wire baskets

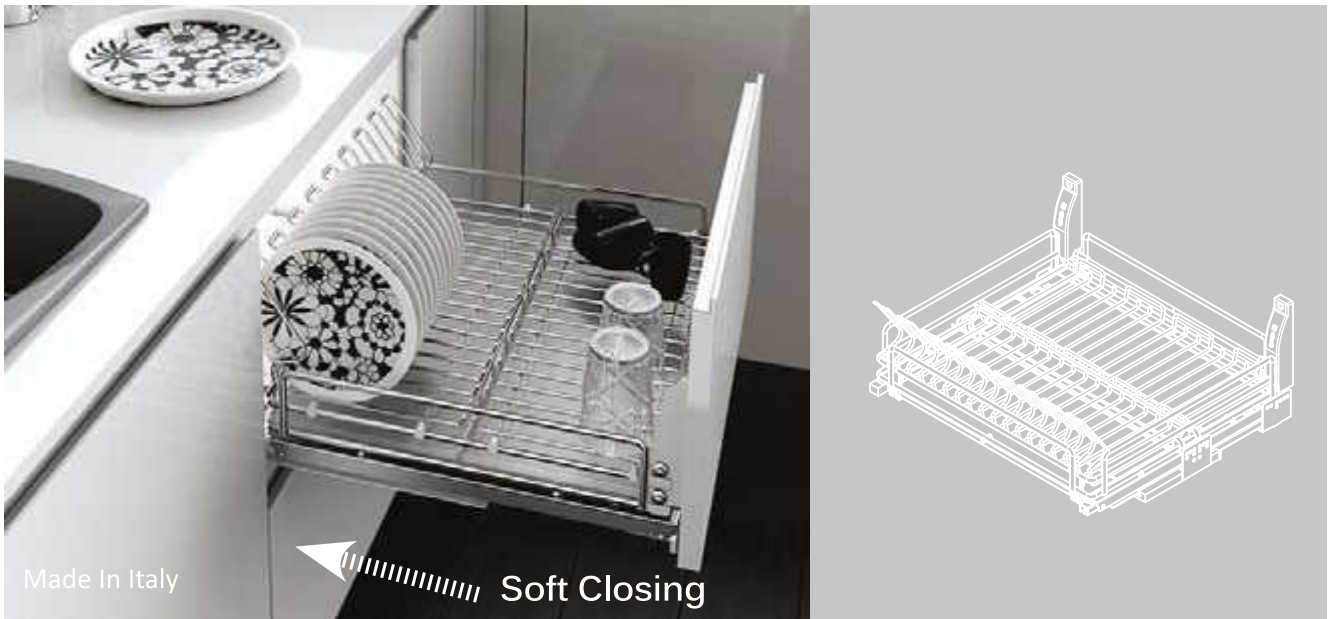

Made In Italy

Soft Closing

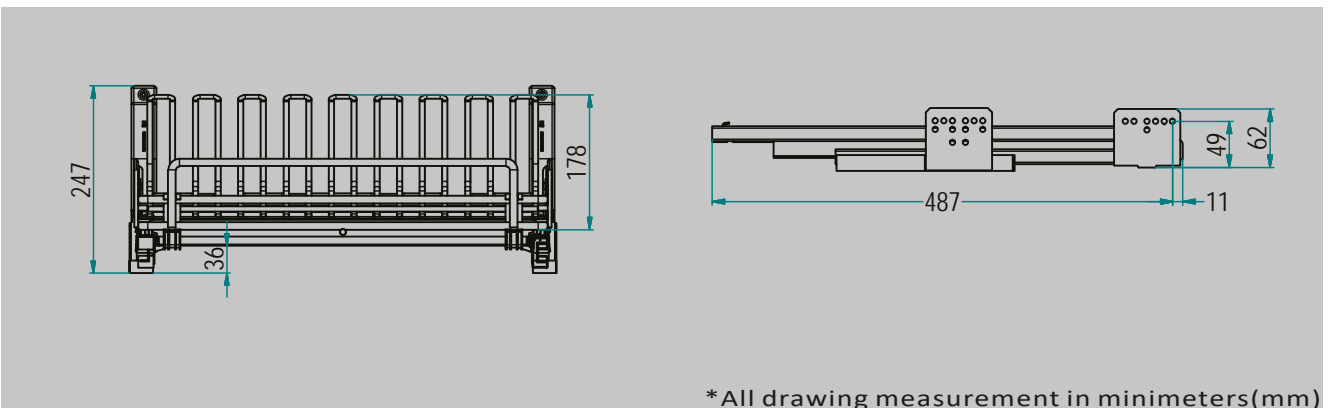

*All drawing measurement in minimeters(mm)

With GRASS Dynamic XP Slides

Load Capacity: 40kg

Item No.	Min. Cabinet Depth (Interior)	Min. Width (Interior)	Height (Interior)
XDU-900	20½"	34⅞"	11"

Maxima Pull Out Pantry

- *Melamine Trays
- *White or Graphite Finish (AR)
- *With GRASS Dynamic XP Slides

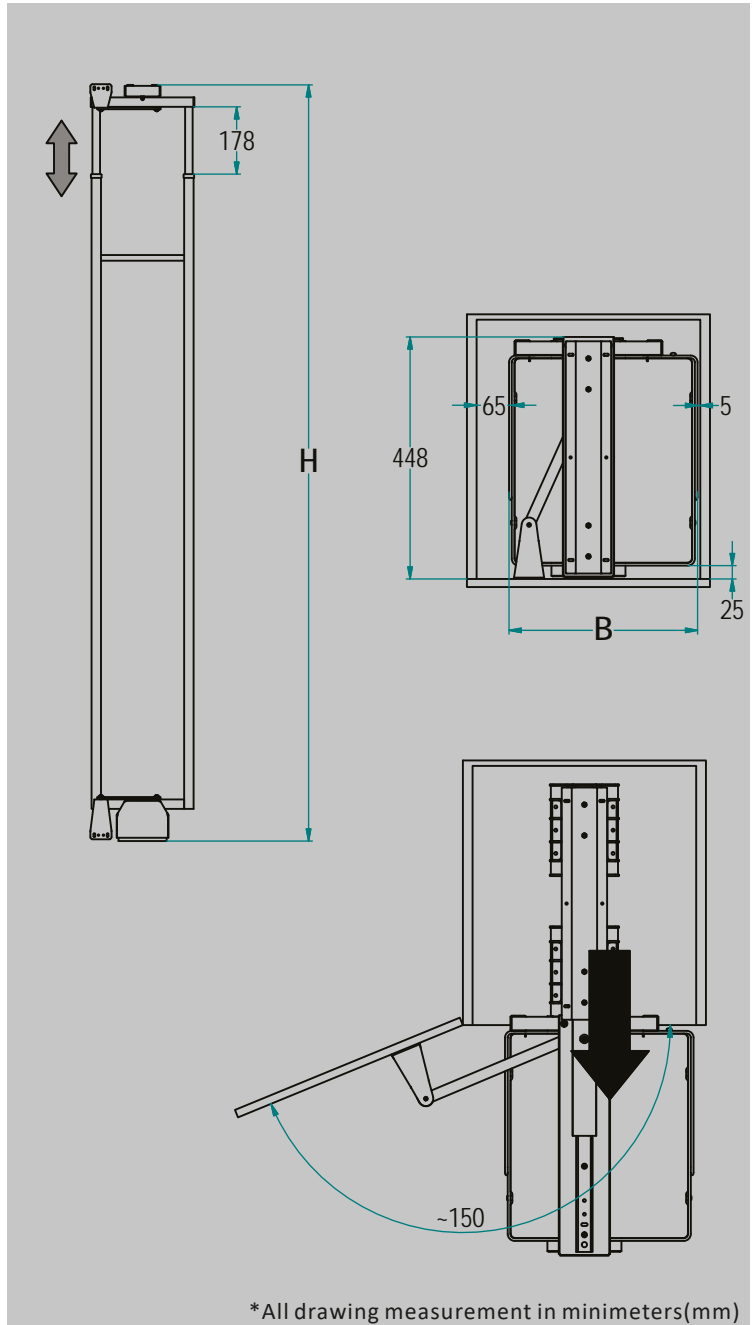

With GRASS Dynamic XP Slides

Load Capacity: 110kg

Item No.	Height (Interior)	Min Cabinet Depth (Interior)	Min. Width (Interior)
XMA-450/450AR	72" ~ 88½"	19"	16½"
XMA-600/600AR	72" ~ 88½"	19"	22½"

Broom Holder

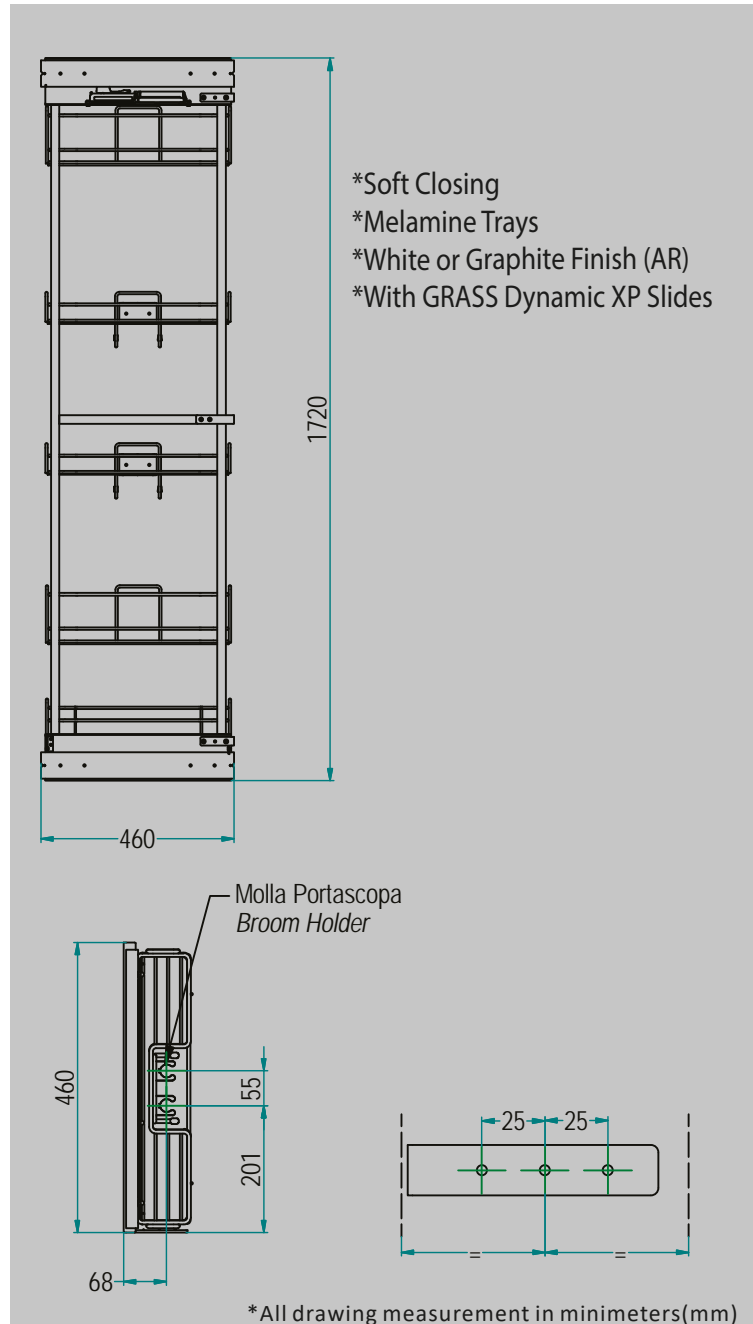

wire baskets

With GRASS Dynamic XP Slides

Load Capacity: 50kg

Item No.	Height (Interior)	Min Cabinet Depth (Interior)	Min. Width (Interior)
XBH-150/150AR	68"	18½"	4½"

Colonna Pull Out Pantry

wire baskets



Made In Italy

Soft Closing

- *Soft Closing
- *Melamine Trays
- *Light Grey Frame with white baskets
- *Graphite Frame XPP-450F with Graphite Baskets XPP-450FAR

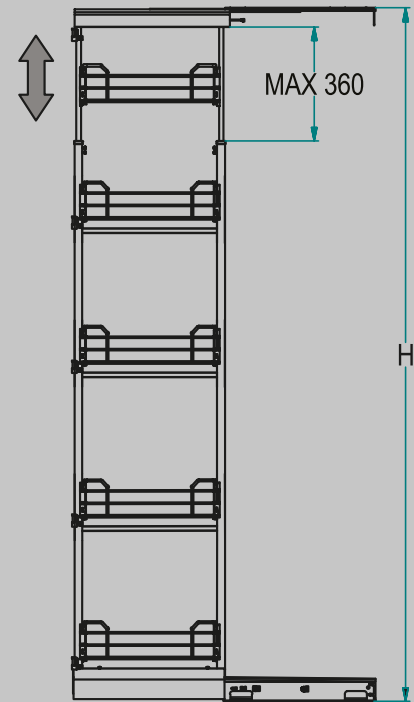

A set of 5 Baskets

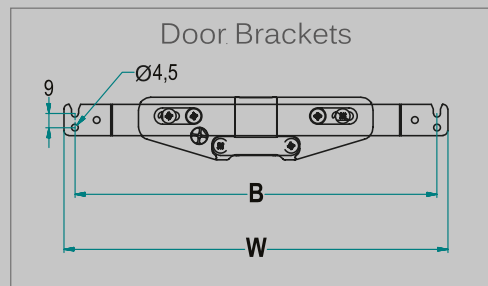

*All drawing measurement in minimeters(mm)

5 Baskets Pull Out Pantry With Thomas Regout Slides

Load Capacity: 120kg

Item No.	Description	Cabinet Height (Interior)	Cabinet Depth (Interior)	Cabinet Width (Interior)
XPP-450F/450FAR	Pantry mechanism (Frame)	72" ~86"	20"	16"
XPP-450B/450BAR	A set of 5 Baskets	—	18"	16"

Wire Baskets



Made in ITALY

Maxima Deluxe Larder Unit



- * Soft Closing
- * Left / Right Interchangeable
- * Melamine Trays
- * 170° Hinges Required (Sold Separately)

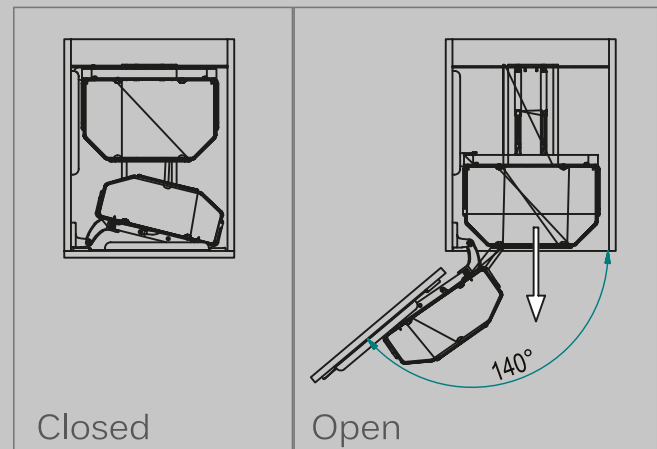
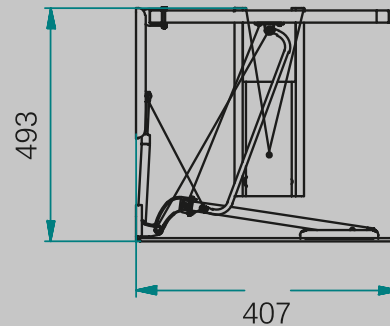

*All drawing measurement in minimeters(mm)

wire baskets

6 Levels (12 Trays)

Load Capacity: 150kg

Item No.	Min. Cabinet Height (Interior)	Min Cabinet Depth (Interior)	Min. Width (Interior)
XLU-808	70"	20"	16½"

Blind Corner Solutions

wire baskets



Each Tray
Installed
Independently

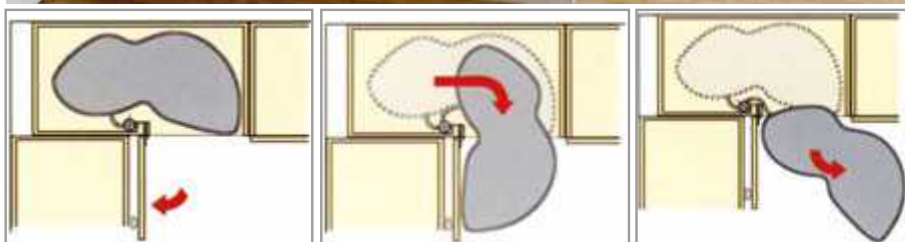

* WLM-004R/004RG (Right Hand Swing)

With Revolving Trays

Item No.	Feature	Basket Size	Min. Opening width	Cabinet Width (internal)
WLM-003L	Left (white)	W32" x D14" x H3½"	16¼"	36"
WLM-004R	Right (white)	W32" x D14" x H3½"	16¼"	36"
WLM-003LG	Left (Grey)	W32" x D14" x H3½"	16¼"	36"
WLM-004RG	Right (Grey)	W32" x D14" x H3½"	16¼"	36"

Blind Corner Solutions

Made in TAIWAN



wire baskets

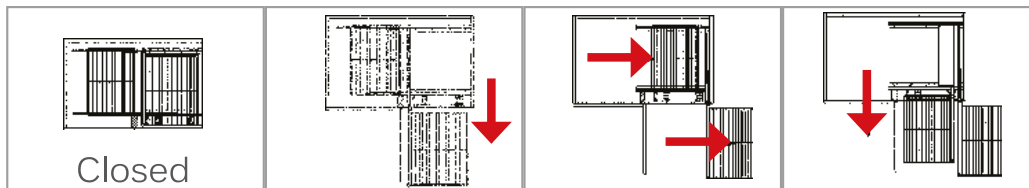

All Baskets Pull Out (Universal)

Item No.	Basket Size	Min. Door Opening	Cabinet Width (internal)	Description
WMC-034	2pc: W12" x D16½" x H4" 2pc: W14" x D18" x H4"	16½"	31"	wire basket

Blind Corner Solutions

Door Mounted

Made in TAIWAN

wire baskets

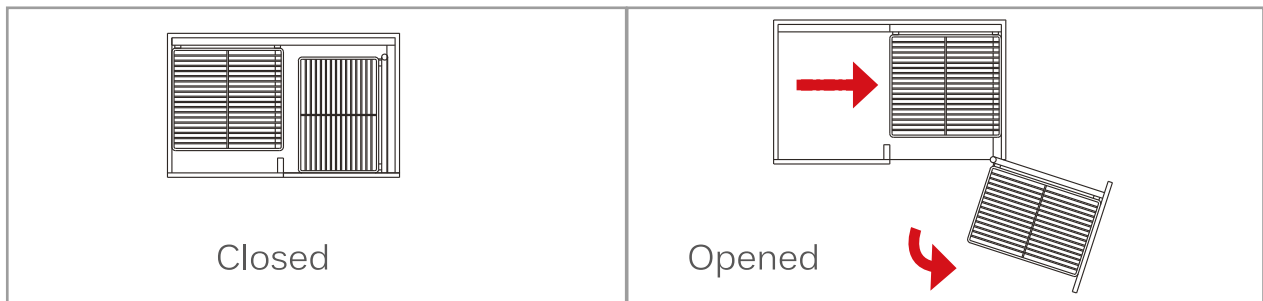

Door Mounted
(Left/Right Universal), Soft Closing

Item No.	Basket Size	Min. Door Opening	Cabinet Width (internal)	Description
WMC-212	2pc: W10" x D17½" x H3½" 2pc: W15" D18" x H3½"	14¼"	33"	wire basket

Corner Lazy Susan Solutions



wire baskets

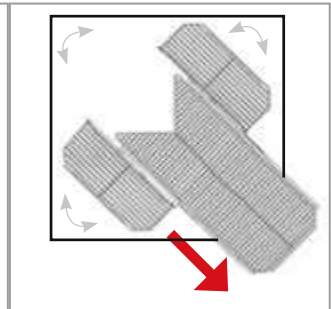
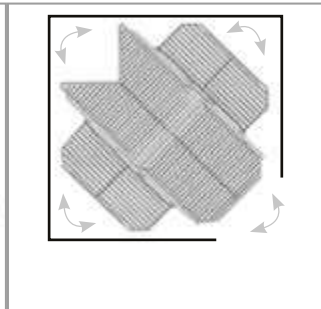
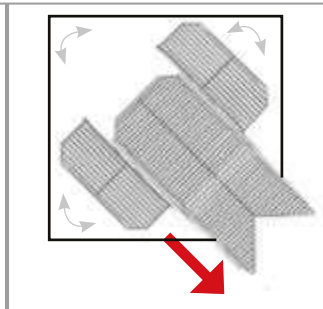
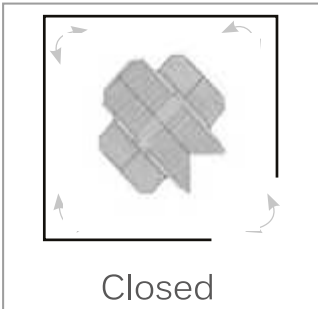

Pull Out Lazy Susan (pull out from both sides)

Item No.	Basket Size	Cabinet Height (Inner)	Cabinet Width (Internal)
WLS-248	2pcs: W14" x D28" x H4" 4pcs: W19" x D7" x H3½"	26"-32"	34" x 34" with minimum opening 16¼" internal

Corner Lazy Susan Solutions

wire baskets

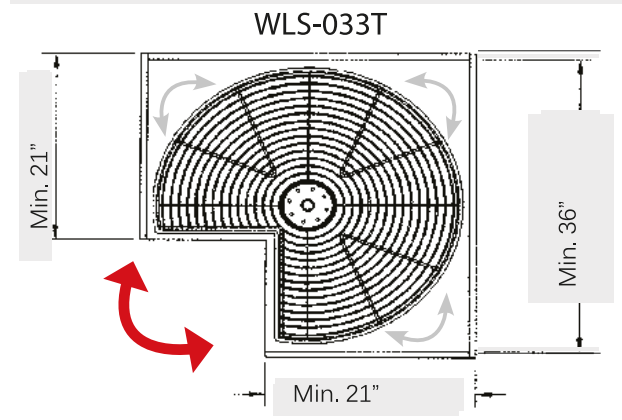
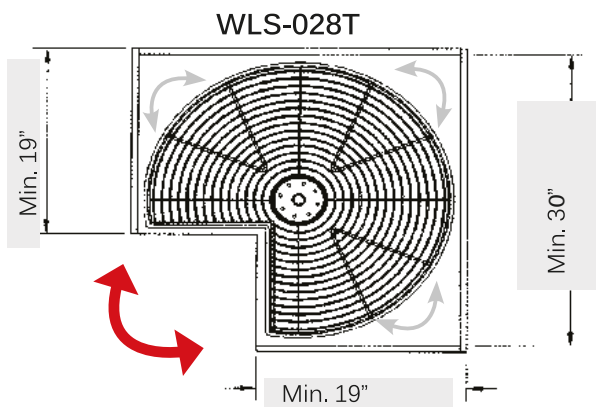

270 Degree Lazy Susan

Item No.	Basket Size	Cabinet Height (Inner)	Cabinet Width (Internal)
WLS-024T	Ø 24" x H3"	25.5"-31.5"	30"
WLS-028T	Ø 28" x H3"	25.5"-31.5"	33"
WLS-033T	Ø 33" x H3"	25.5"-31.5"	36"

Corner Lazy Susan Solutions



Height Adjustable Pole

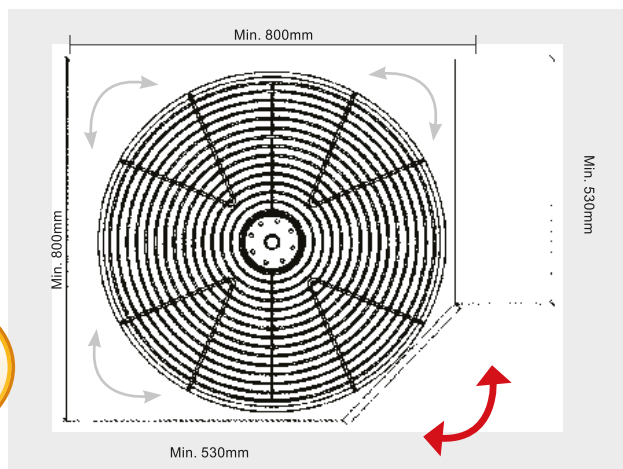

Full Round Lazy Susan

Item No.	Basket Size	Cabinet Width (Internal)	Height (internal)
WLS-018T	Ø 18" x H3"	19½"	24"-31"
WLS-036T	Ø 32" x H3"	36"	24"-31"

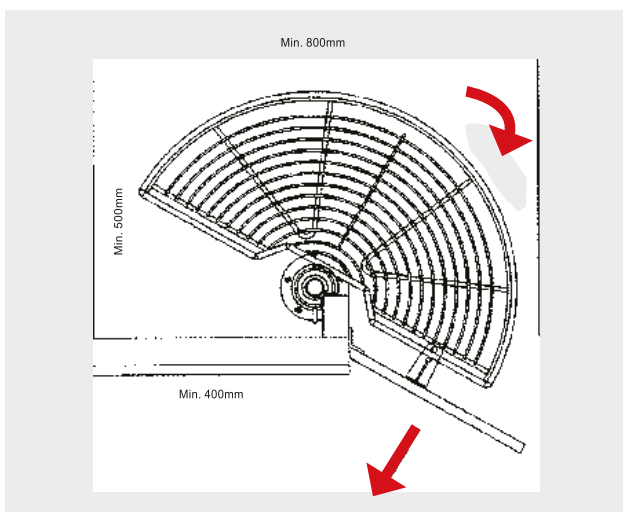

Half Round Lazy Susan

Item No.	Basket Size	Cabinet Width (Internal)	Minimum Opening (internal)
WHR-039T	W25½" x D15" x H3"	28"	17"

wire baskets

2 Level Side Racks



With Door Mounted Brackets
Universal

Item No.	Feature	Product Measurement	Cabinet Width Internal
WCR-204SC	Soft Closing	W4½"xD18½"xH18¼"	4 ½"

wire baskets

3 Level Side Racks



With Door Mounted Brackets
Universal

Item No.	Feature	Product Measurement	Cabinet Width (Internal)	Description
WSR-067SC	Soft Closing	W5½" X D19½" X H27"	5¾"	wire basket
WSR-068SC	Soft Closing	W9" X D19½" X H27"	9¾"	wire basket

Mini Base Cabinet Pull Out Pantry



With Door Mounted Brackets

Item No.	Feature	Min Cabinet (Inner)	Cabinet Width (Internal)
WPP3-14	Soft Closing	W14" x D19½" x H(26" - 29")	15"

Pull Out Pantry

Made in TAIWAN

wire baskets

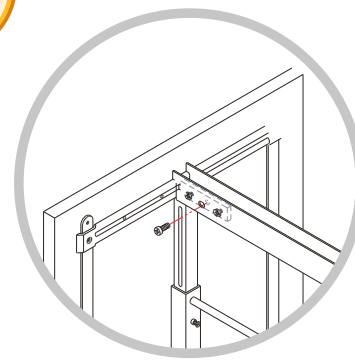

Adjustable Top and Bottom

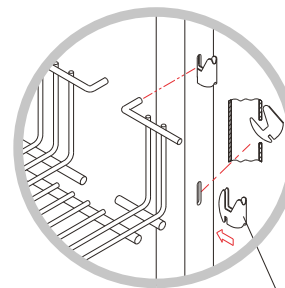

Basket Hanger Clip

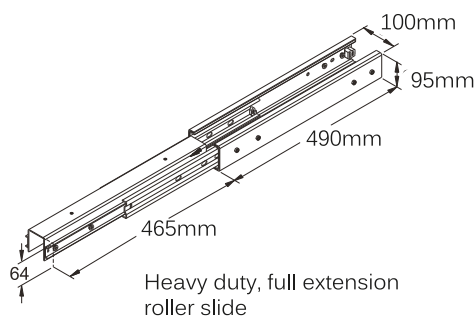

4 Baskets
Load Capacity: 50kg

Item No.	Basket Size	Cabinet Height (Inner)	Cabinet Depth (Inner)	Cabinet Width (Inner)	Description
WPP4-10	W10" x D20" x H3"	50"-64"	21"	11"	wire basket
WPP4-14	W13¾" x D20" x H3"	50"-64"	21"	14½"	wire basket

Pull Out Pantry



Soft Closing

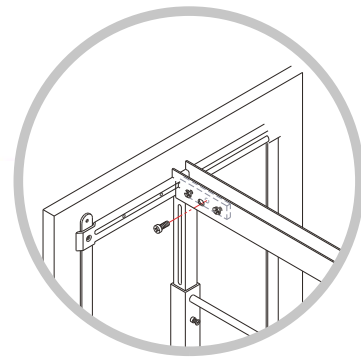

Adjustable Top and Bottom

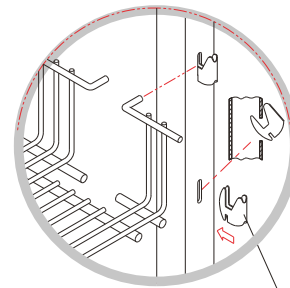

Basket Hanger Clip

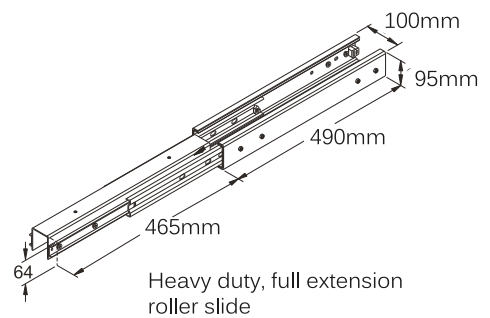

Heavy duty, full extension roller slide

5 Baskets Available in Two Widths
Load Capacity: 50kg

Item No.	Basket Size	Cabinet Height (Inner)	Cabinet Depth (Inner)	Cabinet Width (Inner)	Description
WPP5-10	W10" x D20" x H3"	64"-77"	21"	11"	wire basket
WPP5-14	W13¾" x D20" x H3"	64"-77"	21"	14½"	wire basket

wire baskets

Pull Out Pantry

wire baskets

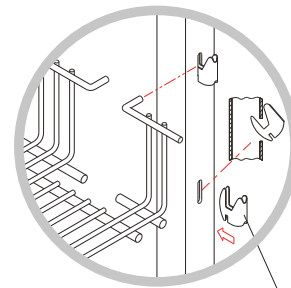

Basket Hanger Clip

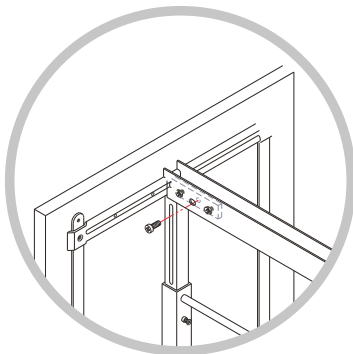

Adjustable Top and Bottom

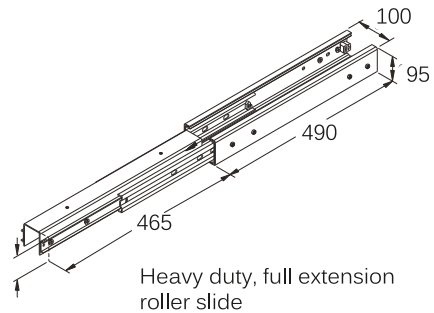

*All drawing measurement in minimeters(mm)

6 Baskets

Load Capacity: 50kg

Item No.	Basket Size	Cabinet Height (Inner)	Cabinet Depth (Inner)	Cabinet Width (Inner)	Description
WPP6-10	W10" x D20"x H3"	72"-85"	21"	11"	wire basket
WPP6-14	W13¾" x D20"x H3"	72"-85"	21"	14½"	wire basket

Door Rack



Door Rack

Made in TAIWAN



wire baskets

Item No.	Description	Size
WBR-305	Bottle Rack	12½" x D4½" x H4½"

Item No.	Description	Size
WSD-12	Door Rack	W8¾" x D2¾" x H17"
WSD-16	Door Rack	W12½" x D2¾" x H17"
WSD-18	Door Rack	W14½" x D2¾" x H17"

Upper Spice Rack



Upper Spice Rack



Item No.	Description	Size
WUR-005	Upper Cabinet Rack	W6¼" x D11" x H18"

Item No.	Description	Size
WUR-026	Upper Cabinet Rack	W6¼" x D11" x H26"

handles & knobs

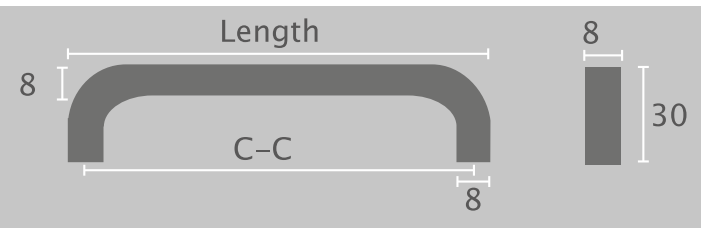

H-002 Standard D Handle - Delta

Material: Solid Steel

Item No.	C-C	Length
H-002-96CP	96	103
H-002-128CP	128	135

Finish  Chrome

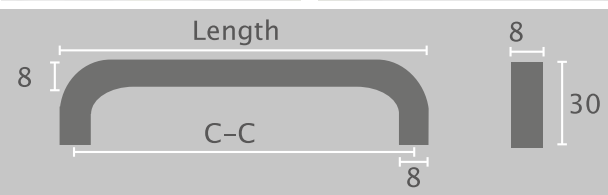

H-002 Standard D Handle - Delta

Material: Solid Steel

Item No.	C-C	Length
H-002 - 96BSS	96	103
H-002-128BSS	128	135

Finish  Satin Nickel

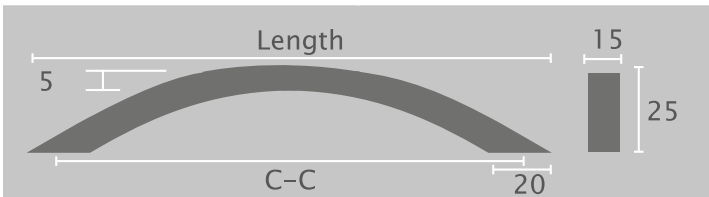

H-009 Flat Top Bow Handle - Arch

Material: Zn-Alloy

Item No.	C-C	Length
H-009-128BSS	128	165

Finish
 Satin Nickel

handles & knobs

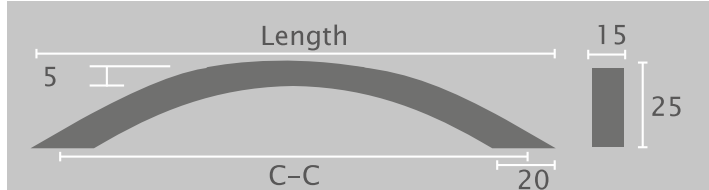

H-009 Flat Top Bow Handle - Arch

Material: Zn-Alloy

Item No.	C-C	Length
H-009-128BN	128	165

Finish
 Black Nickel

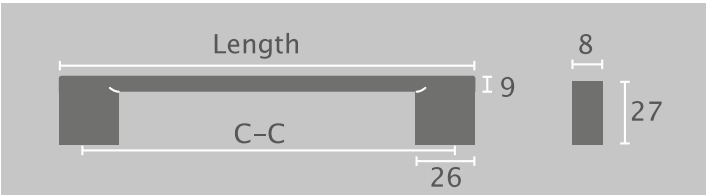
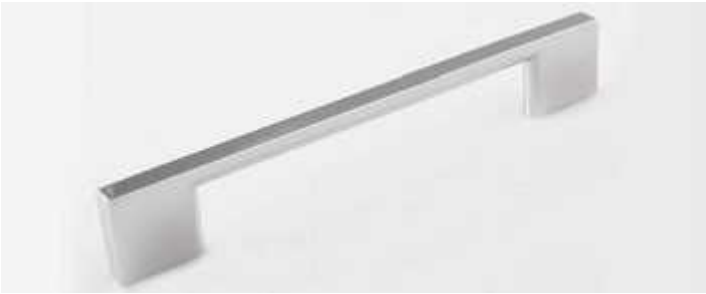

H-013 Slim Profile Handle - **Simplicity**

Material: Zn-Alloy

Item No.	C-C	Length
H-013-128CP	128	161
H-013-160CP	160	193
H-013-192CP	192	225
H-013-224CP	224	256
H-013-256CP	256	289
H-013-320CP	320	354
H-013-416CP	416	449

Finish  Chrome

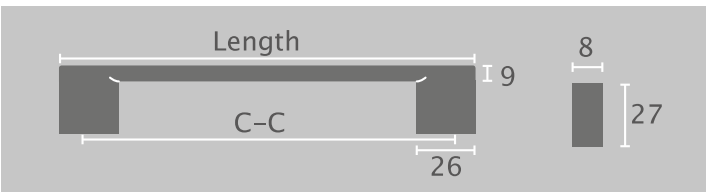

H-013 Slim Profile Handle - **Simplicity**

Material: Zn-Alloy

Item No.	C-C	Length
H-013-128BSS	128	161
H-013-160BSS	160	193
H-013-192BSS	192	225
H-013-224BSS	224	256
H-013-256BSS	256	289
H-013-320BSS	320	354
H-013-416BSS	416	449

Finish  Satin Nickel

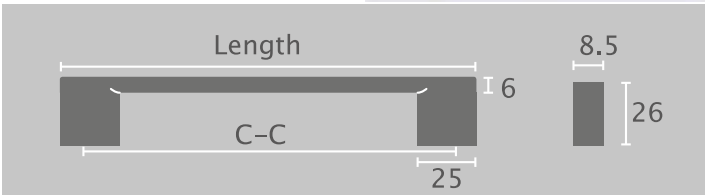
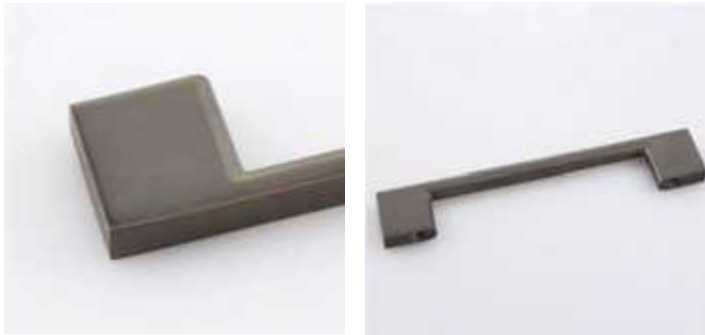

H-013 Slim Profile Handle - *Simplicity*

Material: Zn-Alloy

Item No.	C-C	Length
H-013-128ORB	128	161
H-013-160ORB	160	193
H-013-224ORB	224	256
H-013-320ORB	320	354
H-013-416ORB	416	449

Finish  Oil Brush

handles & knobs

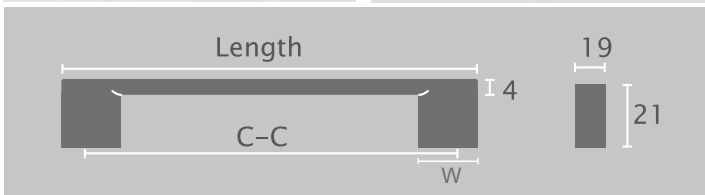

H-017 L-Shaped Finger Pull - *Lounge*

Material: 304 Stainless Steel

Item No.	C-C	Length	W
H-017-96BSS	96	108	15
H-017-128BSS	128	140	17
H-017-160BSS	160	172	20

Finish  Satin Nickel

handles & knobs

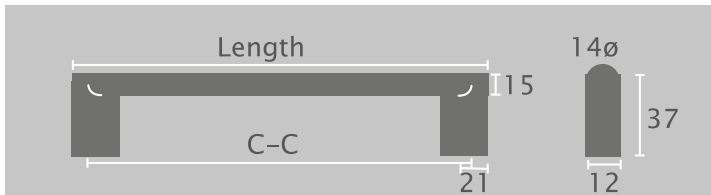

H-019 Square Post Round Handle - Timeless

Material: Zn-Alloy

Item No.	C - C	Length
H-019-128BSS	128	165
H-019-160BSS	160	195
H-019-224BSS	224	260
H-019-256BSS	256	290
H-019-320BSS	320	355

Finish



Satin Nickel

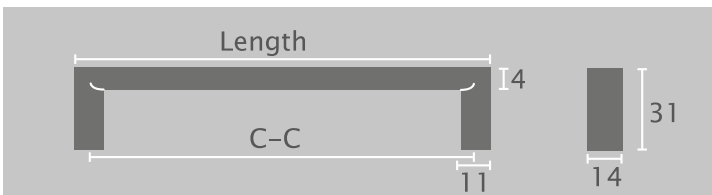

H-022 Half Round D Handle 14mm - Expression

Material: Zn-Alloy

Item No.	C-C	Length
H-022-128ORB	128	136
H-022-160ORB	160	168
H-022-224ORB	224	232
H-022-320ORB	320	328
H-022-416ORB	416	424

Finish



Oil Brush



H-022 Half-Round D Handle - Expression

Material: Zn-Alloy

Item No.	C - C	Length
H-022-128BSS	128	136
H-022-160BSS	160	168
H-022-224BSS	224	232
H-022-320BSS	320	328
H-022-416BSS	416	424

Finish



Satin Nickel

handles & knobs

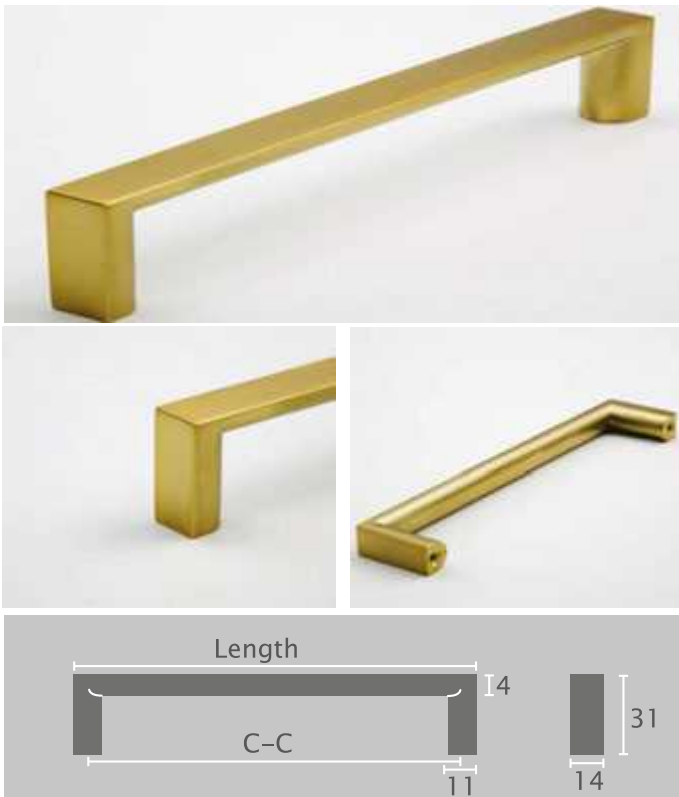

H-022 Half-Round D Handle - Expression

Material: Zn-Alloy

Item No.	C-C	Length
H-022-128SB	128	136
H-022-160SB	160	168
H-022-224SB	224	232
H-022-320SB	320	328

Finish



Rose Gold

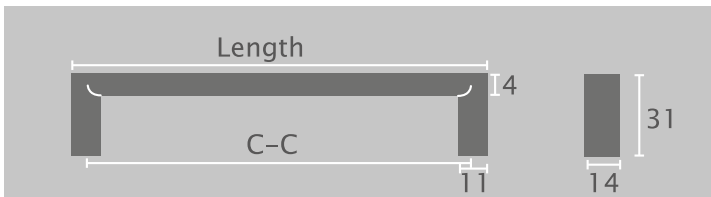

H-022 Half-Round D Handle - Expression

Material: Zn-Alloy

Item No.	C - C	Length
H-022-128BK	128	136
H-022-160BK	160	168
H-022-224BK	224	232
H-022-320BK	320	328

Finish



Matt Black

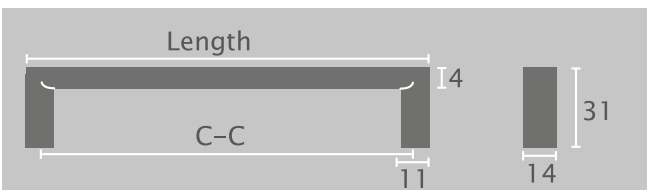

H-022 Half-Round D Handle - Expression

Material: Zn-Alloy

Item No.	C - C	Length
H-022-128CP	128	135
H-022-160CP	160	168
H-022-224CP	224	232
H-022-320CP	320	328
H-022-416CP	416	423

Finish



Chrome

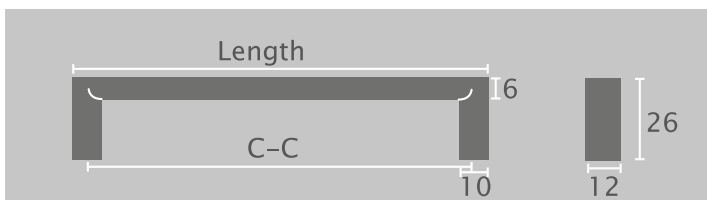
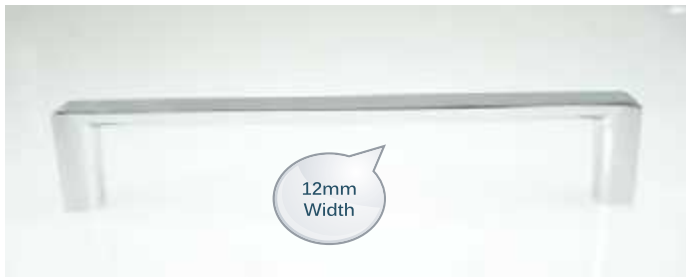

H-033 Half-Round D Handle 11mm - Liberty

Material: Zn-Alloy

Item No.	C - C	Length
H-033-128 CP	128	135
H-033-160 CP	160	171
H-033-192 CP	192	200
H-033-224 CP	224	230
H-033-320 CP	320	326

Finish  Chrome

handles & knobs

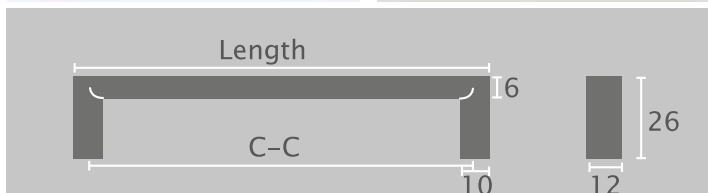
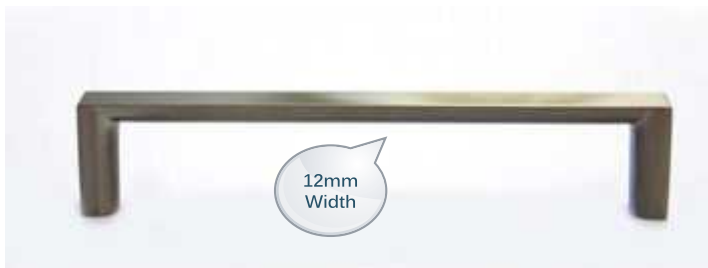

H-033 Half-Round D Handle 11mm - Liberty

Material: Zn-Alloy

Item No.	C - C	Length
H-033-128BSS	128	135
H-033-160BSS	160	171
H-033-192BSS	192	200
H-033-224BSS	224	230
H-033-320BSS	320	326
H-033-416BSS	416	424

Finish  Satin Nickel

handles & knobs

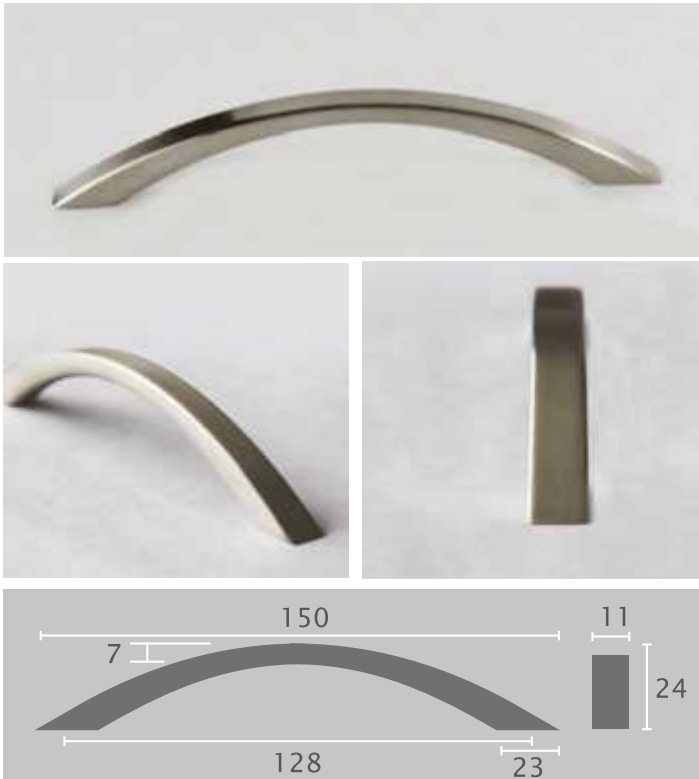

H-045 Square Arc Handle - Sleek

Material: Zn-Alloy

Item No.	C-C	Length
H-045-128BSS	128	151

Finish



Satin Nickel

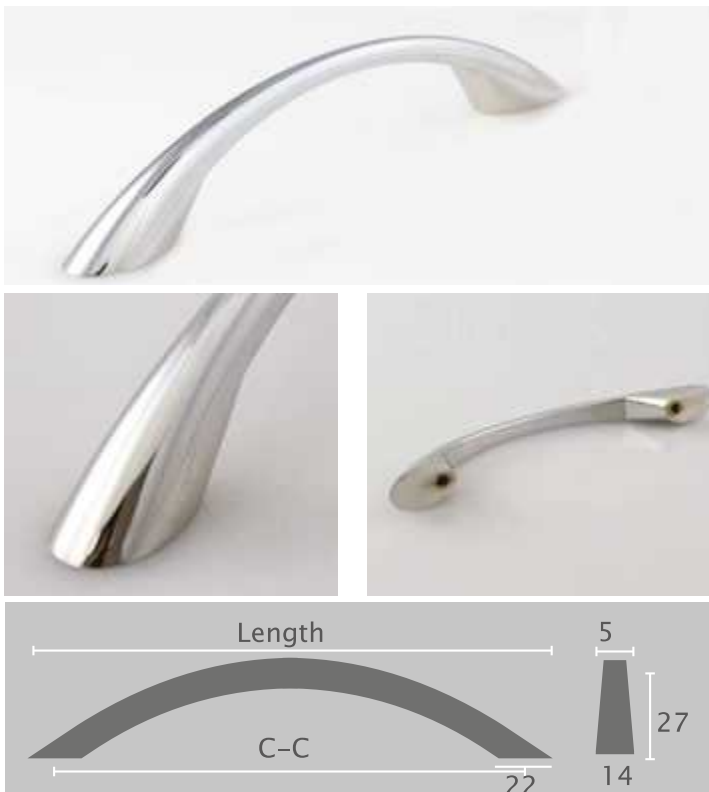

H-047 Round Edge Bow Handle - Charm

Material: Zn-Alloy

Item No.	C-C	Length
H-047 - 96PC	96	134

Finish



Chrome



H-047 Round Edge Bow Handle - Charm

Material: Zn-Alloy

Item No.	C-C	Length
H-047 - 96BSS	96	134

Finish



Satin Nickel

handles & knobs

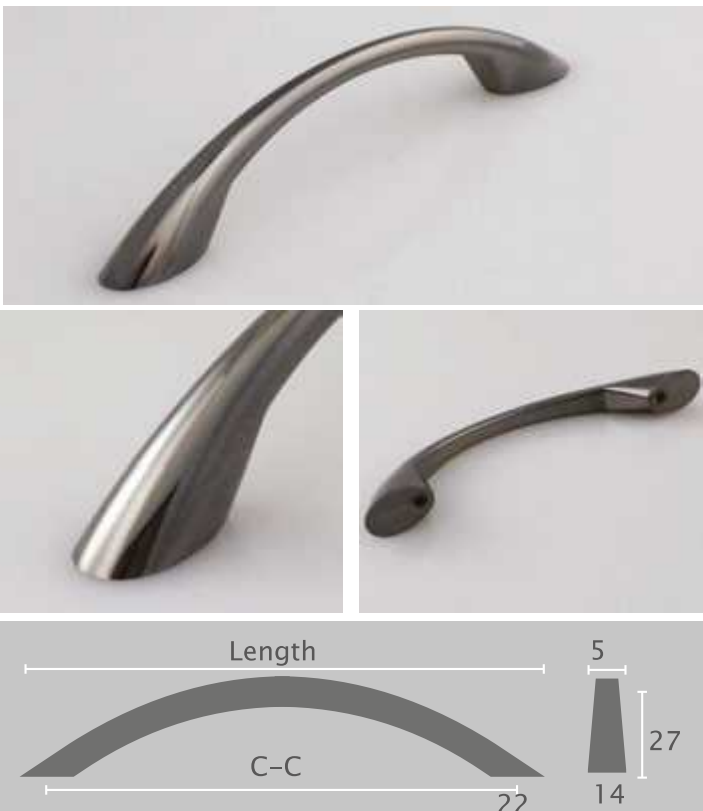

H-047 Round Edge Bow Handle - Charm

Material: Zn-Alloy

Item No.	C-C	Length
H-047 - 96BN	96	134

Finish



Black Nickel

handles & knobs

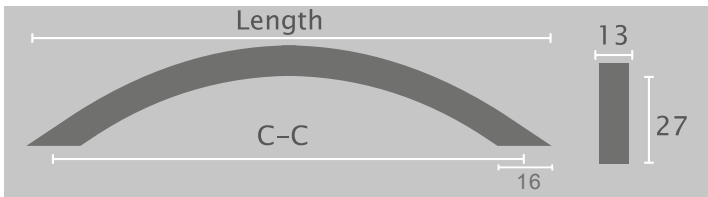

H-048 Standard Bow Handle - Connection

Material: Zn-Alloy

Item No.	C-C	Length
H-048-128BN	128	157

Finish	Color
	Black Nickel

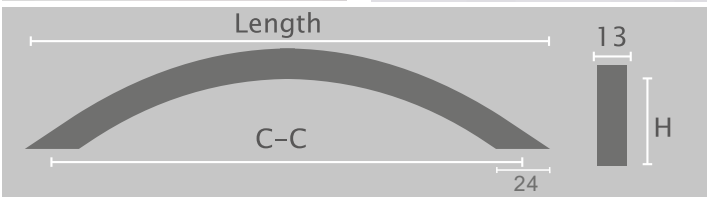

H-048 Standard Bow Handle - Connection

Material: Zn-Alloy

Item No.	C-C	Length	H
H-048-128BSS	128	157	27
H-048-192BSS	192	227	30

Finish	Color
	Satin Nickel

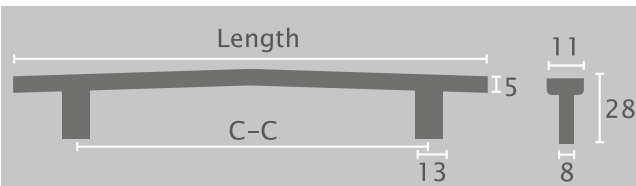

H-064 Flat Curved T-Bar Handle - Extensity

Material: Zn-Alloy

Item No.	C-C	Length
H-064-128BSS	128	194
H-064-192BSS	192	257

Finish  Satin Nickel

handles & knobs

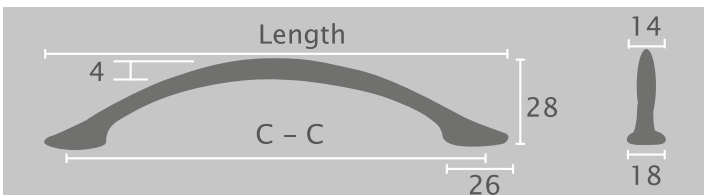

H-068 Bill Handle - Spoonful

Material: Zn-Alloy

Item No.	C-C	Length
H-068-96BSS	96	124
H-068-128BSS	128	153

Finish  Satin Nickel

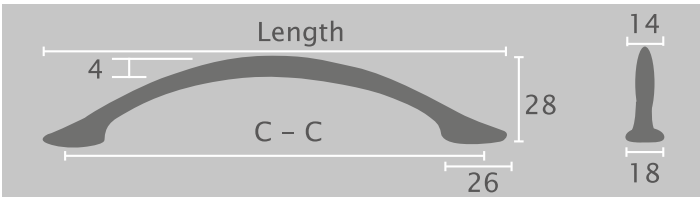

H-068 Bill Handle - Spoonful

Material: Zn-Alloy

Item No.	C-C	Length
H-068-96BN	96	124
H-068-128BN	128	153

Finish  Black Nickel

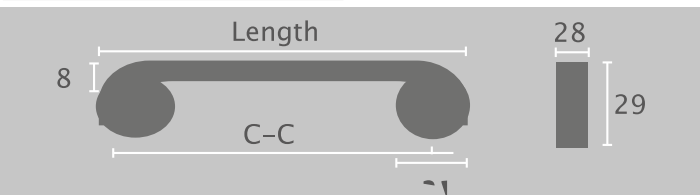

H-092 Swirl Pattern Handle - Swirl'z

Material: Solid Steel

Item No.	C-C	Length
H-092 - 96BSS	96	118
H-092 - 128BSS	128	149

Finish  Satin Nickel

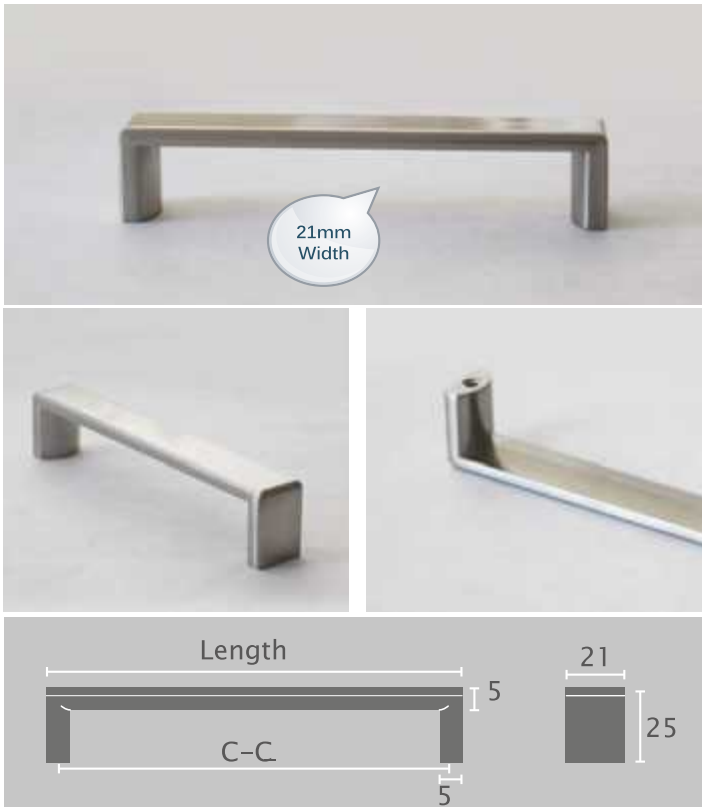

H-101 Bevelled Edge Handle - Sensational

Material: Zn-Alloy

Item No.	C-C	Length
H-101-128BSS	128	135
H-101-160BSS	160	166
H-101-224BSS	224	230
H-101-320BSS	320	328
H-101-416BSS	416	423

Finish  Satin Nickel

handles & knobs



H-108 Bridge Handle - Essential

Material: Zn-Alloy

Item No.	C-C	Length
H-108-128 BK	128	155
H-108-160 BK	160	187
H-108-192BK	192	220
H-108-224 BK	224	253
H-108-320BK	320	348

Finish  Black

handles & knobs

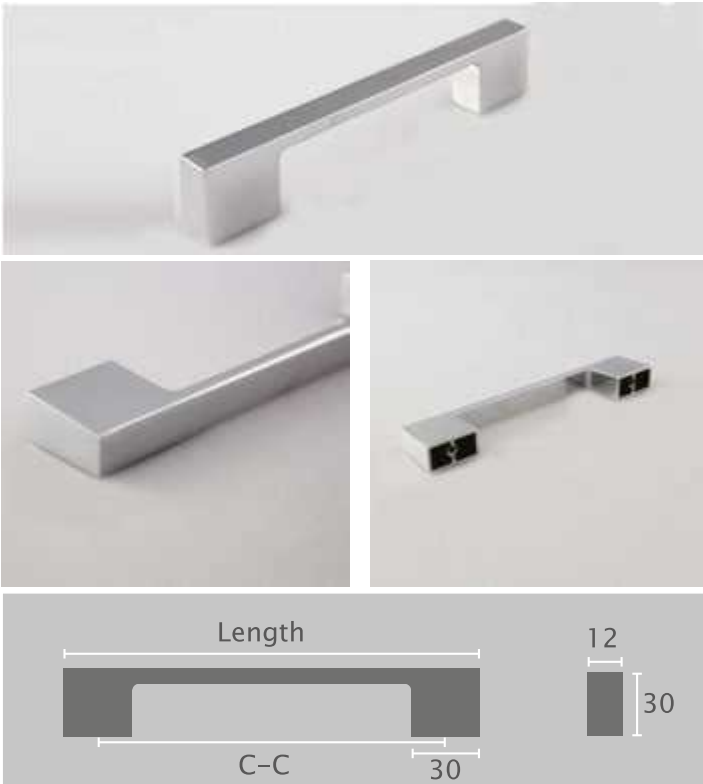

H-108 Bridge Handle - Essential

Material: Zn-Alloy

Item No.	C-C	Length
H-108-128CP	128	155
H-108-160CP	160	187
H-108-224CP	224	253
H-108-320CP	320	348
H-108-416CP	416	445

Finish  Chrome

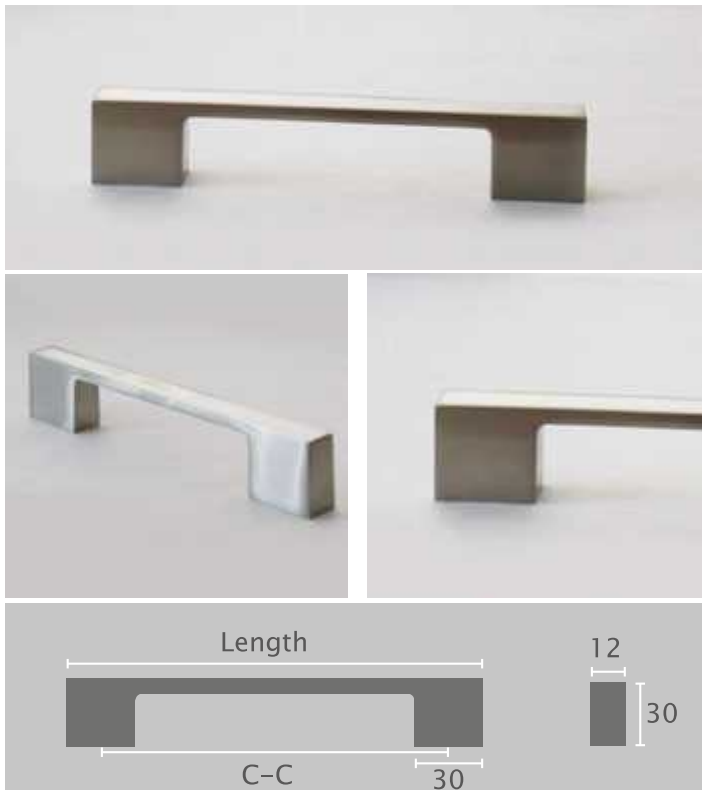

H-108 Bridge Handle - Essential

Material: Zn-Alloy

Item No.	C-C	Length
H-108 - 96BSS	96	135
H-108-128BSS	128	155
H-108-160BSS	160	187
H-108-224BSS	224	253
H-108-320BSS	320	348
H-108-416BSS	416	445

Finish  Satin Nickel

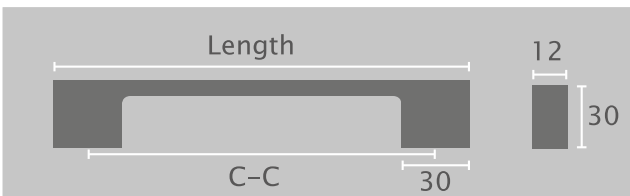

H-108 Bridge Handle - Essential

Material: Zn-Alloy

Item No.	C-C	Length
H-108-128SB	128	154
H-108-160SB	160	168
H-108-224SB	224	253

Finish



Rose Gold

handles & knobs

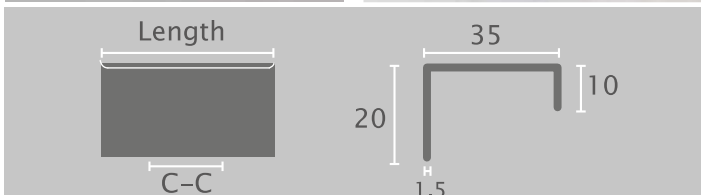

H-117 L-Shaped Finger Pull - Lounge

Material: 304 Stainless Steel

Item No.	C-C	Length
H-117-38BSS	18	38
H-117-40BSS	35	40
H-117-54BSS	34	54
H-117-76BSS	54	76
H-117-200BSS	180	200
H-117-400BSS	382	400

Finish



Satin Nickel

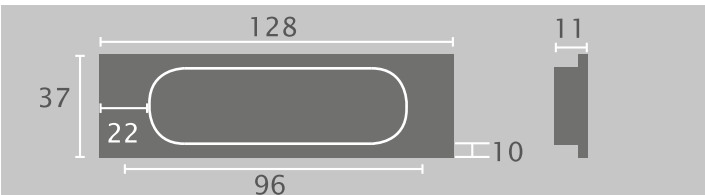

H148 Rectangle Recess Finger Pull - Personality

Material: Zn-Alloy

Item No.	C-C	Length
H-148-96BSS	96	128

Finish  Satin Nickel

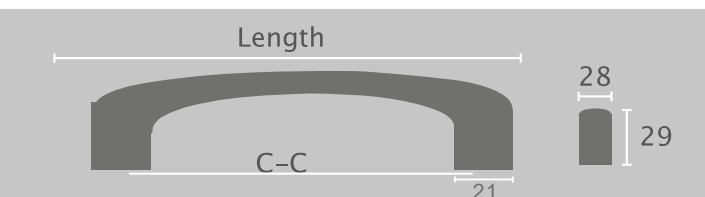

H-151 Phone Handle - Chelsea

Material: Zn-Alloy

Item No.	C-C	Length
H-151-128BSS	128	165
H-151-160BSS	160	195

Finish  Satin Nickel



H-201 Round Corner D Handle - CiCi

Material: Zn-Alloy

Item No.	C-C	Length
H-201-128BSS	128	135
H-201-160BSS	160	168
H-201-224BSS	224	232
H-201-320BSS	320	325
H-201-416BSS	416	420

Finish



Satin Nickel

handles & knobs

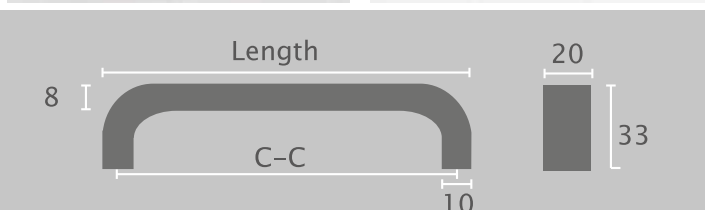

H-208 Round Corner Handle - Modern

Material: Zn-Alloy

Item No.	C-C	Length
H-208-128BSS	128	135
H-208-160BSS	160	165
H-208-224BSS	224	231
H-208-320BSS	320	327
H-208-416BSS	416	425

Finish



Satin Nickel

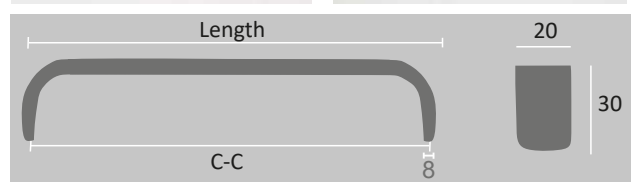

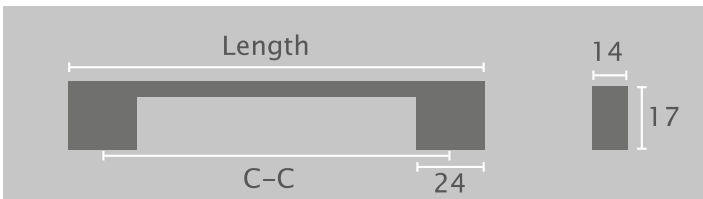

H-213 Oval End Handle - Infinity

Material: Zn-Alloy

Item No.	C-C	Length
H-213-160PC	160	179
H-213-320PC	320	339

Finish  Chrome

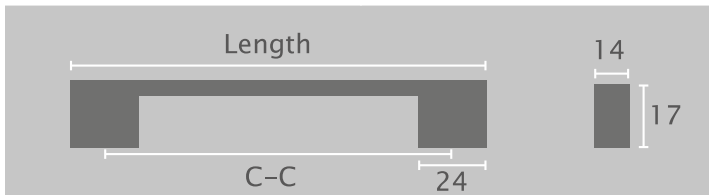

H-213 Oval End Handle - Infinity

Material: Zn-Alloy

Item No.	C-C	Length
H-213-160BSS	160	179
H-213-320BSS	320	339

Finish  Satin Nickel

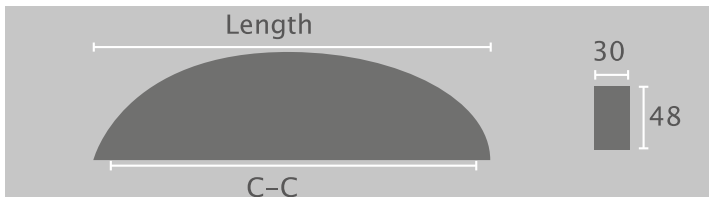

H-214 Cup Handle - Home Accent

Material: Zn-Alloy

Item No.	C-C	Length
H-214-76	76	85

Finish
 Satin Nickel

handles & knobs



H-239 Oval Recess Finger Pull - Creative

Material: Zn-Alloy

Item No.	C-C	Length
H-239-112BSS	112	122

Finish
 Satin Nickel

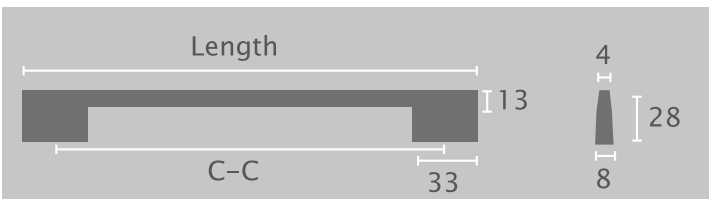

Lorem ipsum

H-254 Slim Arrow Handle - Reflection

Material: Zn-Alloy

Item No.	C-C	Length
H-254-128BSS	128	182
H-254-160BSS	160	219
H-254-224BSS	224	282
H-254-320BSS	320	372
H-254-416BSS	416	474

Finish



Satin Nickel

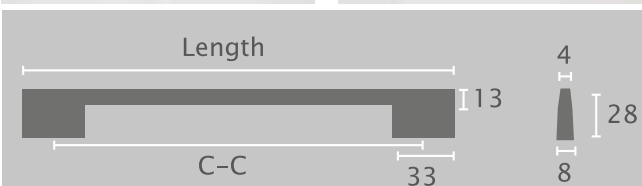

H-254 Slim Arrow Handle - Reflection

Material: Zn-Alloy

Item No.	C-C	Length
H-254-128SB	128	182
H-254-160SB	160	219
H-254-320SB	320	372

Finish



Rose Gold



H-254 Slim Arrow Handle - Reflection

Material: Zn-Alloy

Item No.	C-C	Length
H-254-128CP	128	182
H-254-160CP	160	219
H-254-224CP	224	282
H-254-320CP	320	372
H-254-416CP	416	474

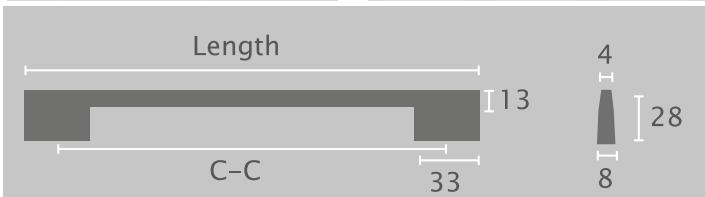

Finish



Chrome

handles & knobs



H-254 Slim Arrow Handle - Reflection

Material: Zn-Alloy

Item No.	C-C	Length
H-254-160BK	160	219
H-254-224BK	224	282
H-254-320BK	320	372

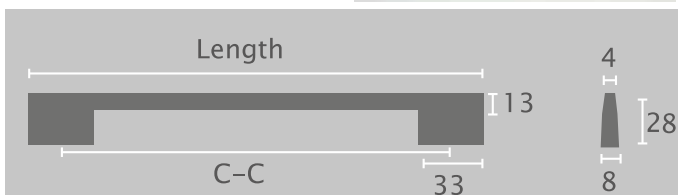

Finish



Black

handles & knobs

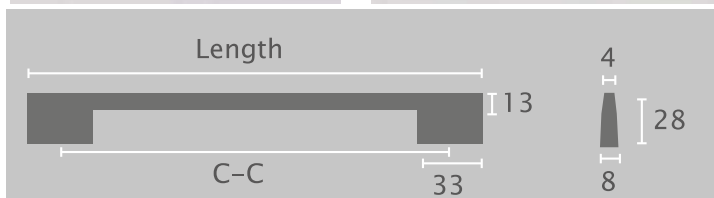

H-254 Slim Arrow Handle - Reflection

Material: Zn-Alloy

Item No.	C-C	Length
H-254-128CP	128	182
H-254-160CP	160	219
H-254-224CP	224	282
H-254-320CP	320	372
H-254-416CP	416	474

Finish  Chrome

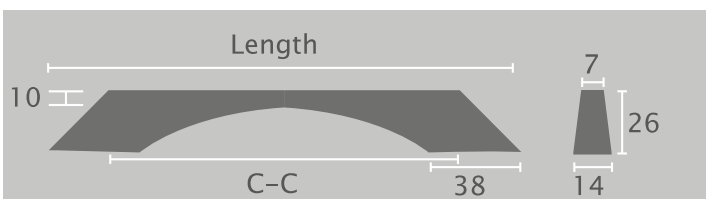

H-258 Mustache Handle - Inspiration

Material: Zn-Alloy

Item No.	C-C	Length
H-258-160CP	160	197
H-258-224CP	224	274

Finish  Chrome

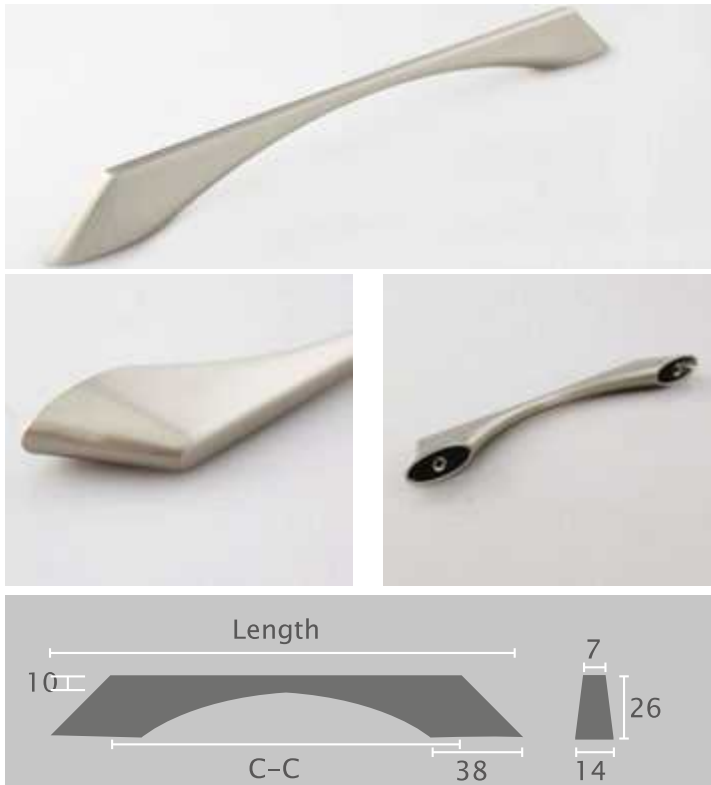

H-258 Mustache Handle - Inspiration

Material: Zn-Alloy

Item No.	C-C	Length
H-258-160BSS	160	197
H-258-224BSS	224	274

Finish



Satin Nickel

handles & knobs

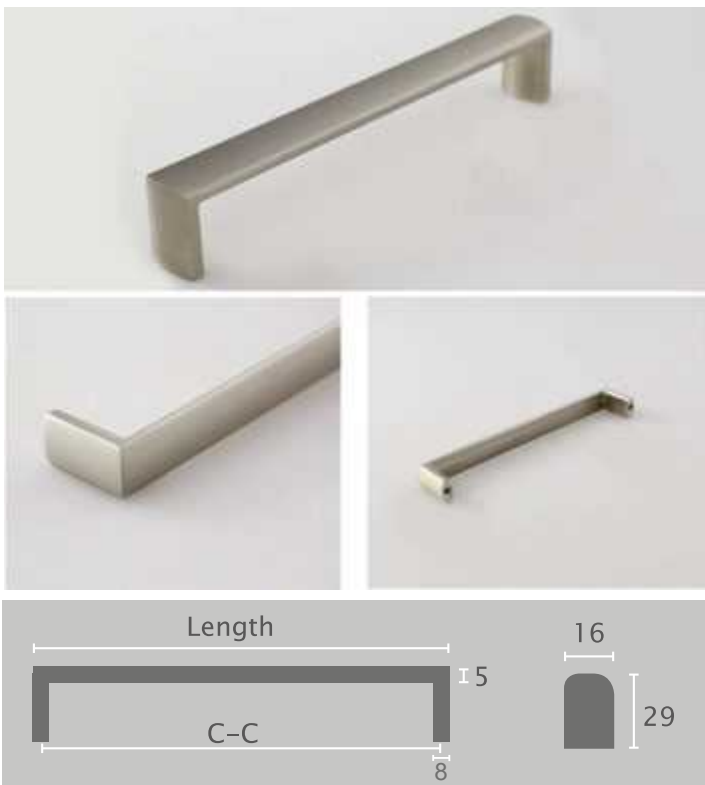

H-301 Radius Top Handle - Confidence

Material: Zn-Alloy

Item No.	C-C	Length
H-301-128BSS	128	132
H-301-160BSS	160	164
H-301-192BSS	192	198
H-301-256BSS	256	261

Finish



Satin Nickel

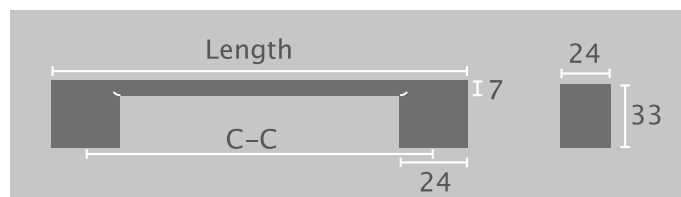
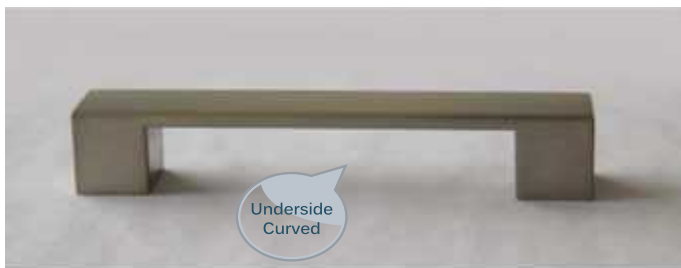

H-322 Plank Square Handle - Determination

Material: Zn-Alloy

Item No.	C-C	Length
H-322-128BSS	128	158
H-322-160BSS	160	190
H-322-224BSS	224	254
H-322-320BSS	320	349
H-322-416BSS	416	445

Finish



Satin Nickel

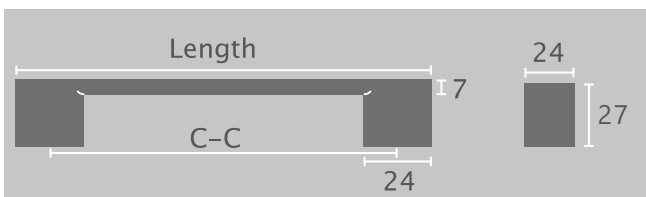

H-322 Plank Square Handle - Determination

Material: Zn-Alloy

Item No.	C-C	Length
H-322-128CP	128	182

Finish



Chrome

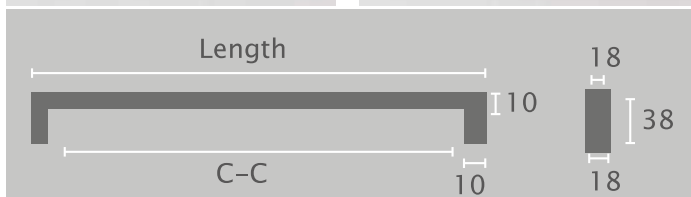

H-324 Layer Edge Handle - Perfection

Material: Zn-Alloy

Item No.	C-C	Length
H-324-128AIH	128	137

Finish



Antique Oil Pilter

handles & knobs

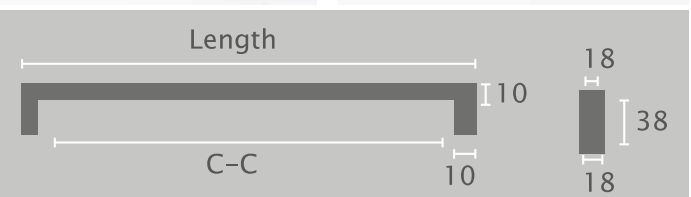

H-324 Layer Edge Handle - Perfection

Material: Zn-Alloy

Item No.	C-C	Length
H-324-128ORB	128	137
H-324-224ORB	224	236
H-324-320ORB	320	332
H-324-416ORB	416	428

Finish



Oil Brush



H-344 Patterned Handle - Dramatic

Material: Zn-Alloy

Item No.	C-C	Length
H-344-128AIH	128	136

Finish  **Antique Oil Pilter**



H-344 Patterned Handle - Dramatic

Material: Zn-Alloy

Item No.	C-C	Length
H-344-128ORB	128	136

Finish  **Oil Brush**

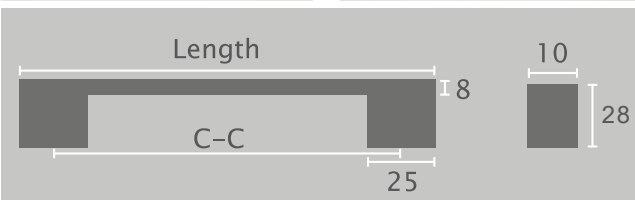

H-355 Plank Square Handle - *Modernity*

Material: Zn-Alloy

Item No.	C-C	Length
H-355-128CP	128	159
H-355-160CP	160	191
H-355-224CP	224	256
H-355-320CP	320	349

Finish



Chrome

handles & knobs

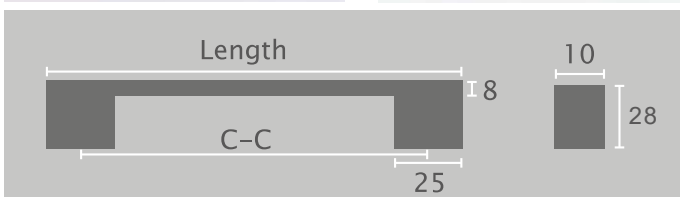

H-355 Plank Square Handle - *Modernity*

Material: Zn-Alloy

Item No.	C-C	Length
H-355-128ORB	128	159
H-355-224ORB	224	256
H-355-320ORB	320	350

Finish



Oil Brush

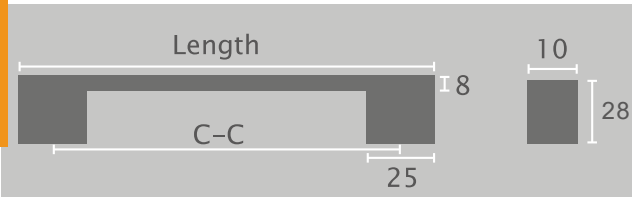

H-355 Plank Square Handle - *Modernity*

Material: Zn-Alloy

Item No.	C-C	Length
H-355-96SB	96	127
H-355-224SB	128	160
H-355-128SB	224	256
H-355-320SB	320	350

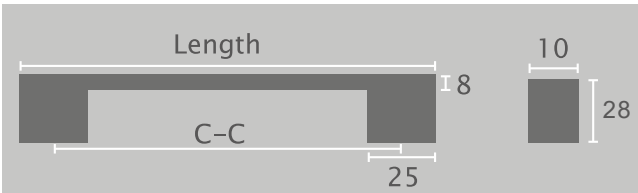
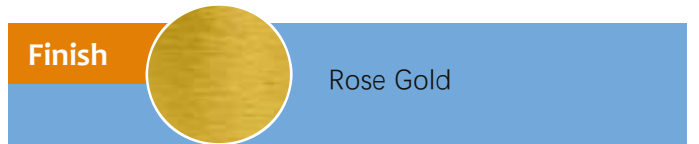

H-355 Plank Square Handle - *Modernity*

Material: Zn-Alloy

Item No.	C-C	Length
H-355-128MBC	128	160
H-355-224MBC	224	256
H-355-320MBC	320	350



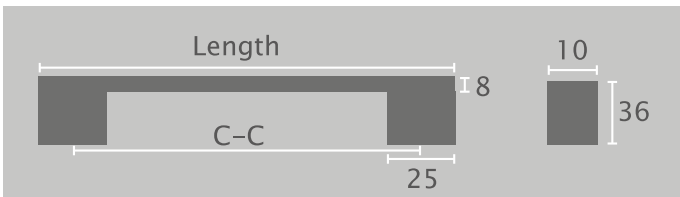

H-355 Plank Square Handle - *Modernity*

Material: Zn-Alloy

Item No.	C-C	Length
H-355-96BSS	96	127
H-355-128BSS	128	159
H-355-160BSS	160	191
H-355-192BSS	192	222
H-355-224BSS	224	256
H-355-320BSS	320	350
H-355-416BSS	416	446

Finish



Satin Nickel

handles & knobs

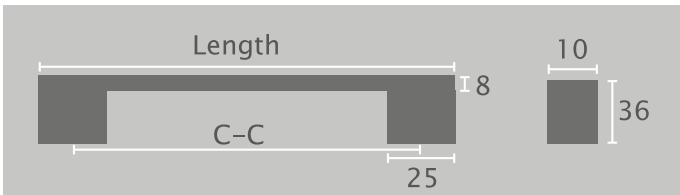

H-355 Plank Square Handle - *Modernity*

Material: Zn-Alloy

Item No.	C-C	Length
H-355-96BK	96	127
H-355-128 BK	128	159
H-355-192 BK	192	222
H-355-224 BK	224	256
H-355-320 BK	320	350

Finish



Matt Black

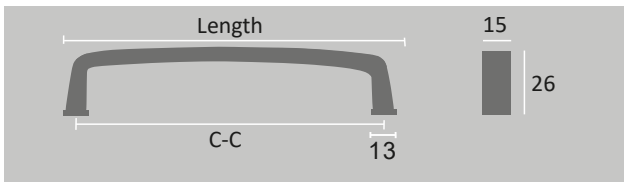

H-359 Line Edge Handle - Transitional

Material: Zn-Alloy

Item No.	C-C	Length
H-359-128BSS	128	140

Finish  Satin Nickel

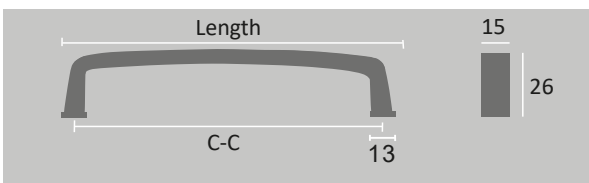

H-359 Line Edge Handle - Transitional

Material: Zn-Alloy

Item No.	C-C	Length
H-359-128AS	128	140

Finish  Antique Silver

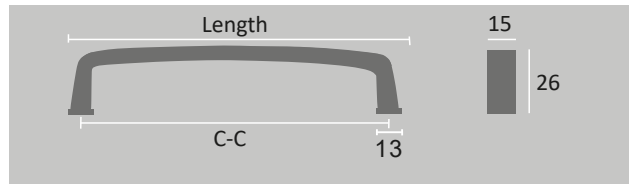

H-359 Line Edge Handle - Transitional

Material: Zn-Alloy

Item No.	C-C	Length
H-359-128BK	128	140

Finish  Matt Black

handles & knobs

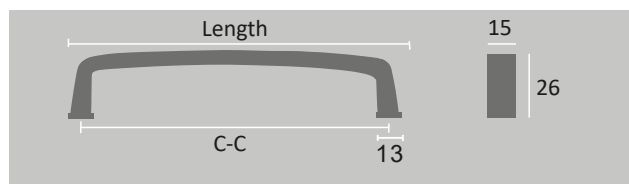

H-359 Line Edge Handle - Transitional

Material: Zn-Alloy

Item No.	C-C	Length
H-359-128ORB	128	140

Finish  Oil Brush



H-374 Patterned Handle - *Dramatic*

Material: Zn-Alloy

Item No.	C-C	Length
H-374-128ORB	128	146

Finish  Oil Brush



H-374 Patterned Handle - *Symphony*

Material: Zn-Alloy

Item No.	C-C	Length
H-374-128AIH	128	146

Finish  Antique Oil Pilter

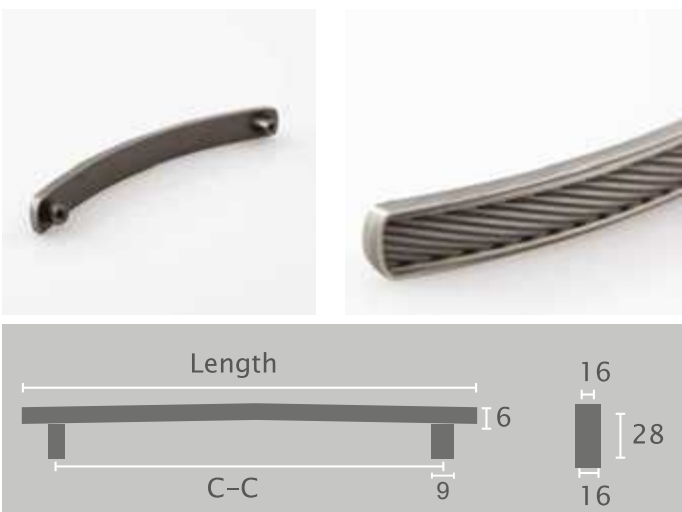

handles & knobs

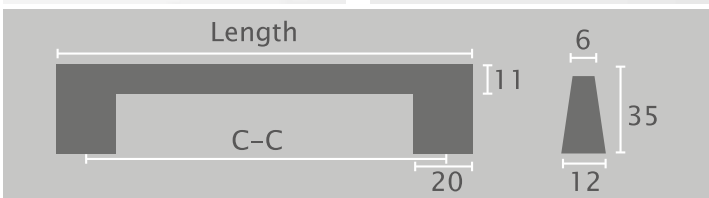

H-444 Pyramid Handle - Triangel

Material: Zn-Alloy

Item No.	C-C	Length
H-444-128BSS	128	158
H-444-160BSS	160	190
H-444-224BSS	224	254
H-444-320BSS	320	350
H-444-416BSS	416	446

Finish



Satin Nickel

handles & knobs

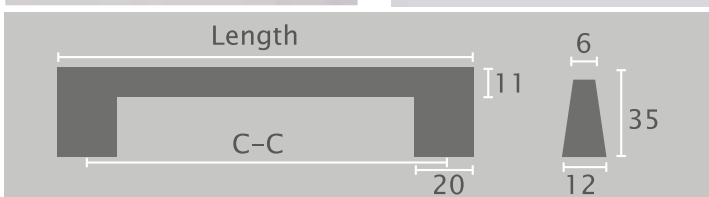

H-444 Pyramid Handle - Triangel

Material: Zn-Alloy

Item No.	C-C	Length
H-444-128CP	128	158
H-444-160CP	160	190
H-444-224CP	224	254

Finish



Chrome

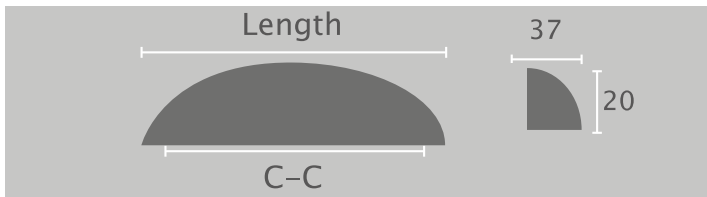

H-459 Cup Handle - Moments

Material: Zn-Alloy

Item No.	C-C	Length
H-459-76VBH	76	120

Finish  **Antique Oil Brushed**

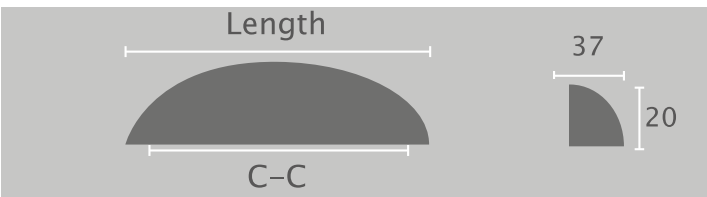

H-459 Cup Handle - Moments

Material: Zn-Alloy

Item No.	C-C	Length
H-459-76BSS	76	120

Finish  **Satin Nickel**

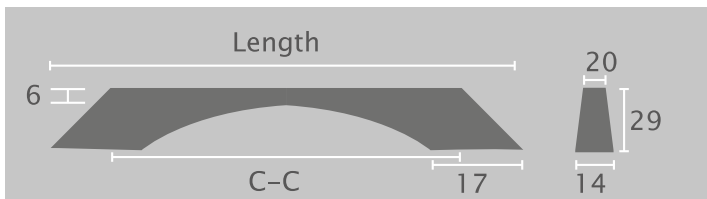

H-460 Mustache Handle - Symmetric

Material: Zn-Alloy

Item No.	C-C	Length
H-460-128BSS	128	142
H-460-160BSS	160	173
H-460-256BSS	256	270

Finish



Satin Nickel

handles & knobs

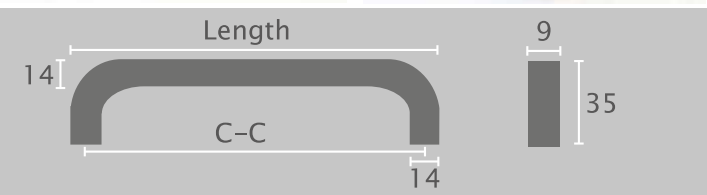

H-463 Round-Corner Square Handle - French Flair

Material: 304 Stainless Steel

Item No.	C-C	Length
H-463-128BSS	128	140
H-463-160BSS	160	172
H-463-224BSS	224	237
H-463-320BSS	320	332
H-463-416BSS	416	428

Finish



Satin Nickel

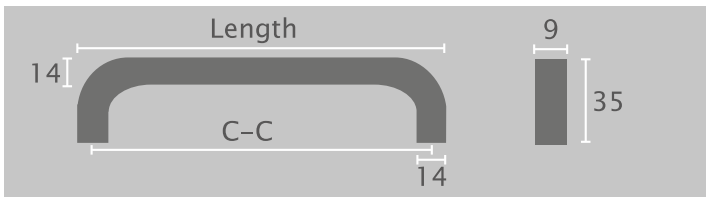

H-463 Round-Corner Square Handle - French Flair

Material: 304 Stainless Steel

Item No.	C-C	Length
H-463-128ORB	128	140
H-463-320ORB	320	332

Finish  Oil Brush

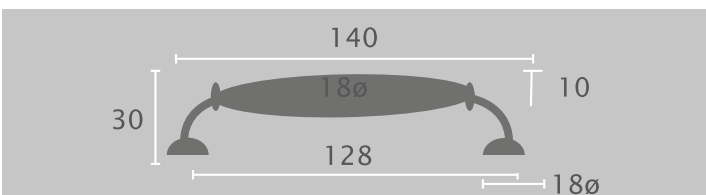

H-468 Round Edge Bow Handle - Passion

Material: Zn-Alloy

Item No.	C-C	Length	H
H-468 -128BSS	128	140	30

Finish  Satin Nickel

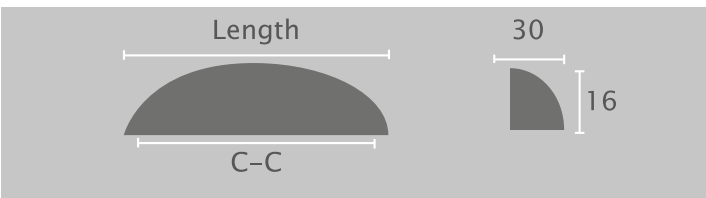

H-471 Cup Handle - Fantasy

Material: Zn-Alloy

Item No.	C-C	Length
H-471-76CP	76	95

Finish	Chrome
	

handles & knobs

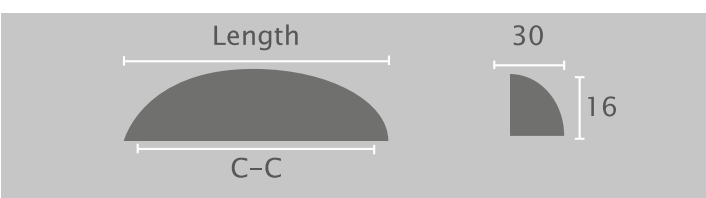

H-471 Cup Handle - Fantasy

Material: Zn-Alloy

Item No.	C-C	Length
H-471-76BSS	76	95

Finish	Satin Nickel
	

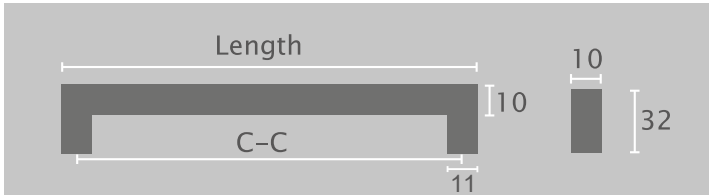
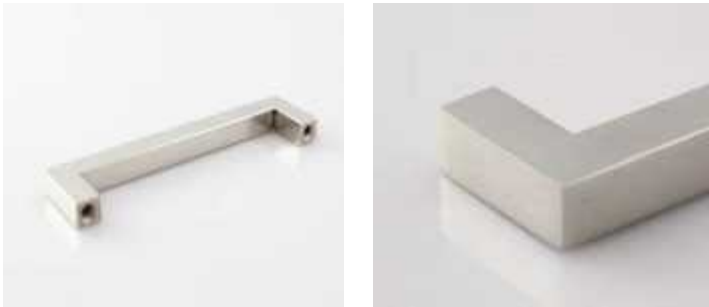

H-502 All Square Block Handle - Perfect Symmetry

Material: 304 Stainless Steel

Item No.	C-C	Length
H-502-128CP	128	140
H-502-160CP	160	172
H-502-224CP	224	236
H-502-320CP	320	332
H-502-416CP	416	428
H-502-608CP	608	620

Finish  Chrome

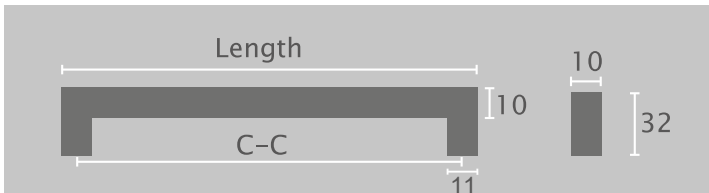
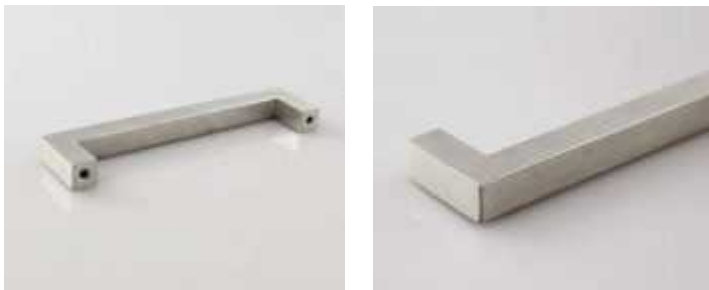

H-502 All Square Block Handle - Perfect Symmetry

Material: 304 Stainless Steel

Item No.	C-C	Length
H-502-96BSS	96	108
H-502-128BSS	128	140
H-502-160BSS	160	172
H-502-224BSS	224	236
H-502-320BSS	320	332
H-502-416BSS	416	428
H-502-608BSS	608	620

Finish  Satin Nickel

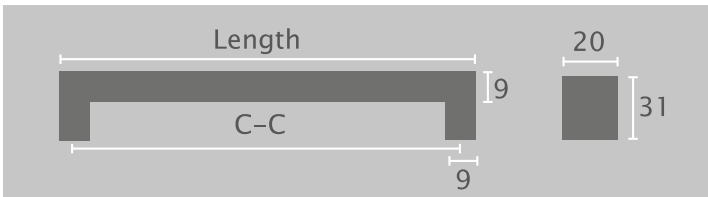
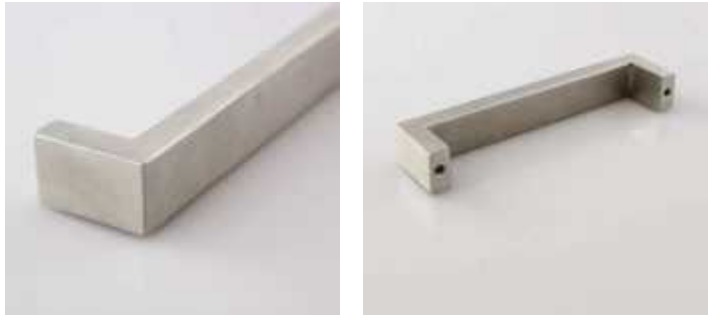

H-503 Flat Square Block Handle - **Sturdy**

Material: 304 Stainless Steel

Item No.	C-C	Length
H-503-128BSS	128	136
H-503-224BSS	224	232
H-503-320BSS	320	330
H-503-416BSS	416	425
H-503-608BSS	608	617

Finish



Satin Nickel

handles & knobs

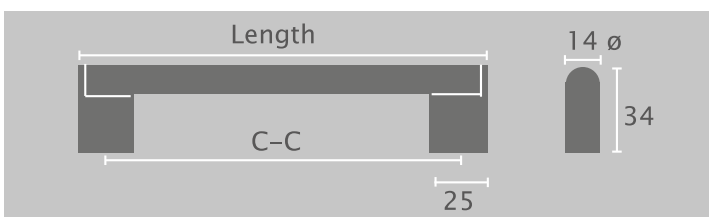
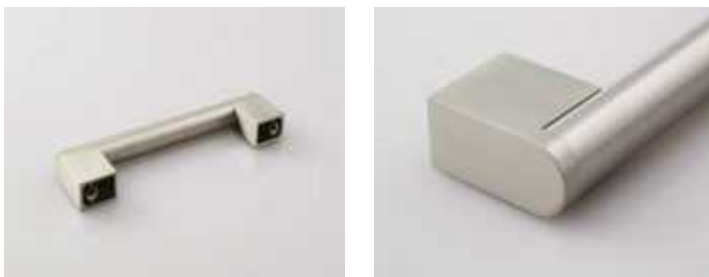

121

H-508B Round Bar Handle - **Effective**

Material: Zn-Alloy

Item No.	C-C	Length
H-508B-128BSS	128	168
H-508B-160BSS	160	200
H-508B-224BSS	224	264
H-508B-320BSS	320	360
H-508B-416BSS	416	456
H-508B-608BSS	608	648

Finish



Satin Nickel

Hollow Inside

handles & knobs

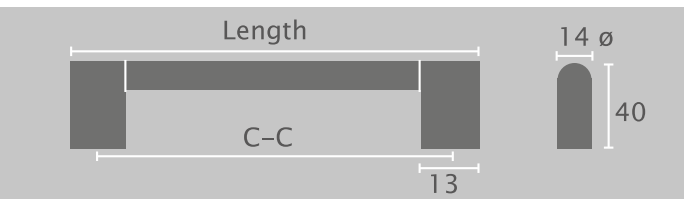

H-509 Round Bar Handle - *Admiration*

Material: Zn-Alloy

Item No.	C-C	Length
H-509-128BSS	128	145
H-509-160BSS	160	177
H-509-224BSS	224	240
H-509-320BSS	320	336
H-509-416BSS	416	432
H-509-480BSS	480	496

Finish  Satin Nickel

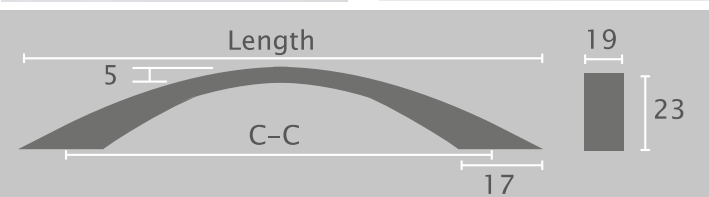

H-533 Flat-Arc Handle - *Elegance*

Material: Zn-Alloy

Item No.	C-C	Length
H-533-128	128	163
H-533-160	160	195
H-533-192	192	226
H-533-224	224	260

Finish  Satin Nickel



H-60304-128BSS

Material: Zn-Alloy

Item No.	C-C	Length
H-60304-128BSS	128	148

Finish



Satin Nickel

handles & knobs

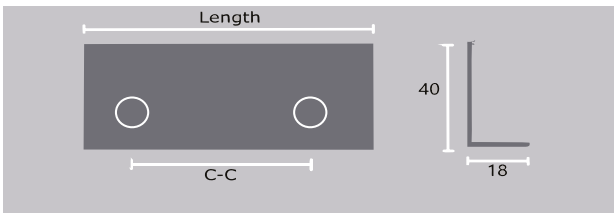

H-60304-128BBA

Material: Zn-Alloy

Item No.	C-C	Length
H-60304-128BBA	128	148

Finish



Brush Black

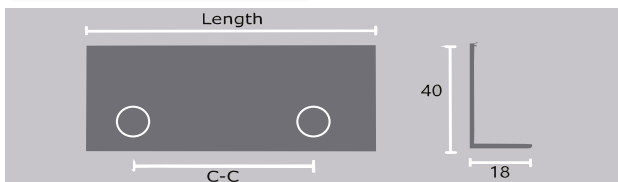

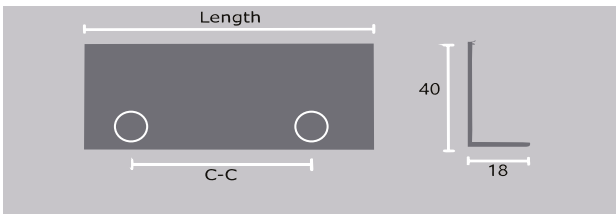

H-60304-128BK

Material: Zn-Alloy

Item No.	C-C	Length
H-60304-128BK	128	148

Finish		Black
--------	---	-------

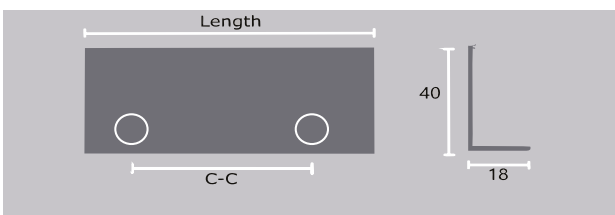
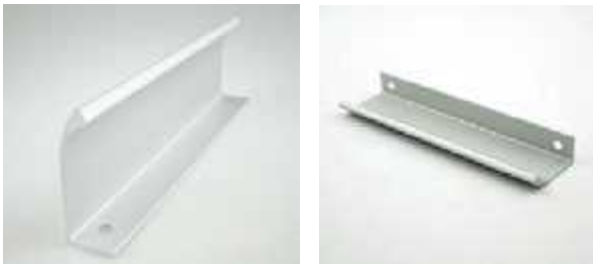

H-60304-128ALA

Material: Zn-Alloy

Item No.	C-C	Length
H-60304-128ALA	128	148

Finish		Aluminum
--------	--	----------



H-60304-128CP

Material: Zn-Alloy

Item No.	C-C	Length
H-60304-128CP	128	148

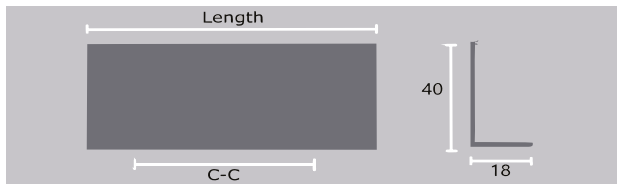

Finish



Chrome

handles & knobs



H-60304-128RG

Material: Zn-Alloy

Item No.	C-C	Length
H-60304-128RG	128	148

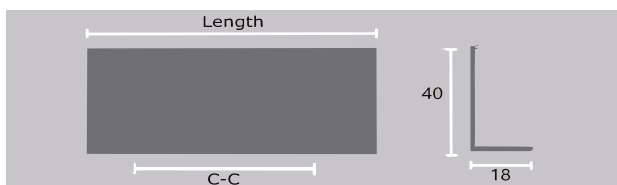

Finish



Rose Gold

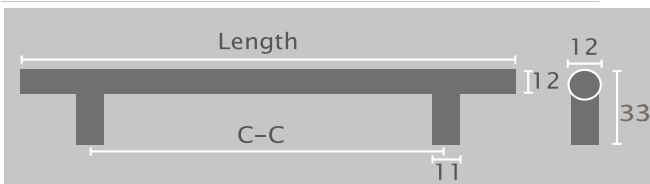

H-60927

Material: Zn-Alloy

Item No.	C-C	Length
H-60927-128BSS	128	180
H-60927-192BSS	192	245
H-60927-320BSS	320	373

Finish



Satin Nickel

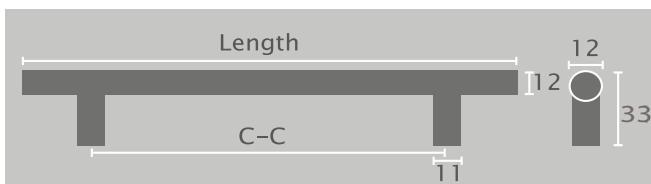

H-60927

Material: Zn-Alloy

Item No.	C-C	Length
H-60927-128BK	128	180
H-60927-192BK	192	245
H-60927-320BK	320	373

Finish



Black

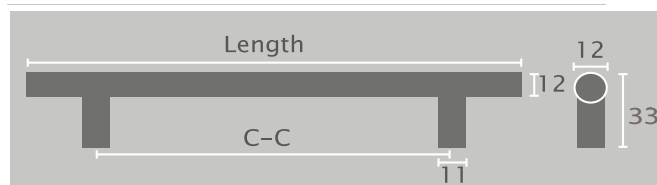

H-60927

Material: Zn-Alloy

Item No.	C-C	Length
H-60927-128GL	128	180
H-60927-192GL	192	245
H-60927-320GL	320	373

Finish



Gold

handles & knobs

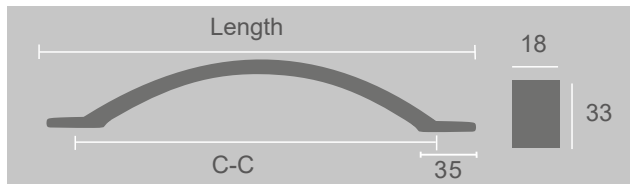

H-61008 Classic Fusion Handle - Transitional

Material: Zn-Alloy

Item No.	C-C	Length
H-61008-128BSS	128	187

Finish



Satin Nickel

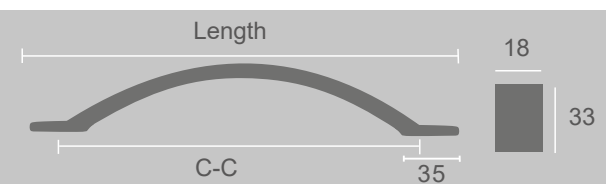

H-61008 Classic Fusion Handle - Transitional

Material: Zn-Alloy

Item No.	C-C	Length
H-61008-128MBC	128	187

Finish



Matte Black Chrome



H-61158 Tapered Mercury Handle - Curvy

Material: Zn-Alloy

Item No.	C-C	Length
H-61158-160BSS	160	204

Finish



Satin Nickel

handles & knobs



H-61158 Tapered Mercury Handle - Curvy

Material: Zn-Alloy

Item No.	C-C	Length
H-61158-160PC	160	204

Finish



Chrome



H-61159 Square Block Handle with Skirt - Whimsical

Material: Zn-Alloy

Item No.	C-C	Length
H-61159-96BSS	96	108
H-61159-128BSS	128	147
H-61159-160BSS	160	178
H-61159-192BSS	192	210
H-61159-224BSS	224	241
H-61159-320BSS	320	337

Finish



Satin Nickel

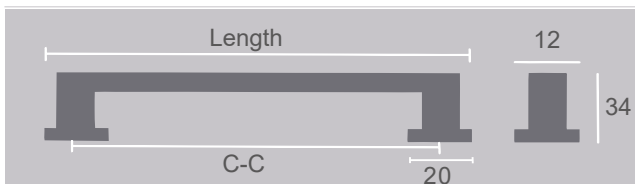

H-61159 Square Block Handle with Skirt - Whimsical

Material: Zn-Alloy

Item No.	C-C	Length
H-61159-128ORB	128	147
H-61159-192ORB	192	210
H-61159-320ORB	320	337

Finish



Oil Brush

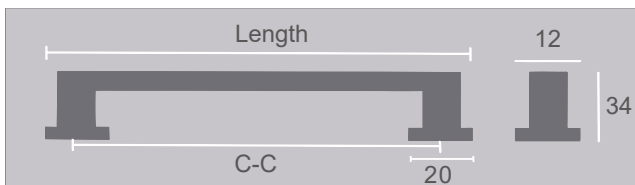

H-61159 Square Block Handle with Skirt - Whimsical

Material: Zn-Alloy

Item No.	C-C	Length
H-61159-96BK	96	108
H-61159-128BK	128	147
H-61159-160BK	160	178
H-61159-192BK	192	210
H-61159-224BK	224	241
H-61159-320BK	320	337

Finish



Matt Black

handles & knobs

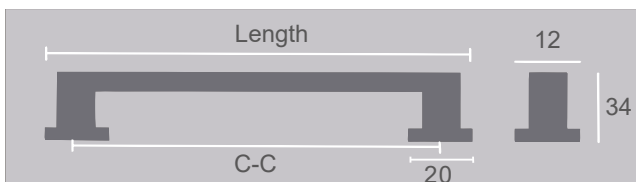

H-61159 Square Block Handle with Skirt - Whimsical

Material: Zn-Alloy

Item No.	C-C	Length
H-61159-96SB	96	108
H-61159-128SB	128	147
H-61159-160SB	160	178
H-61159-192SB	192	210
H-61159-224SB	224	241
H-61159-320SB	320	337

Finish



Rose Gold

handles & knobs



H-61159 Square Block Handle with Skirt - Whimsical

Material: Zn-Alloy

Item No.	C-C	Length
H-61159-96CP	96	108
H-61159-128CP	128	147
H-61159-160CP	160	178
H-61159-192CP	192	210
H-61159-224CP	224	241
H-61159-320CP	320	337

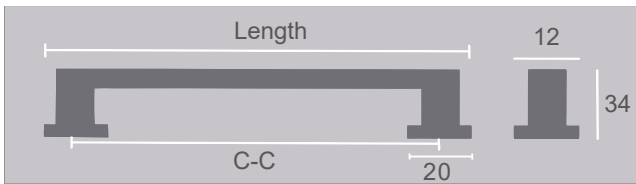

Finish



Chrome

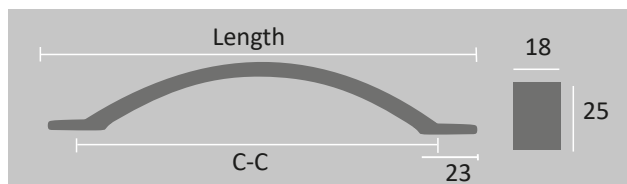

H-61226

Material: Zn-Alloy

Item No.	C-C	Length
H-61226-128BK	128	165

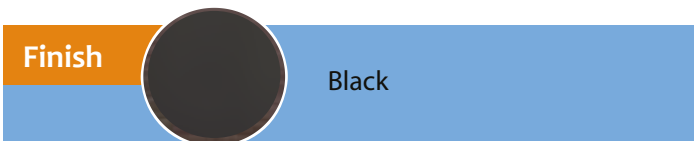

handles & knobs

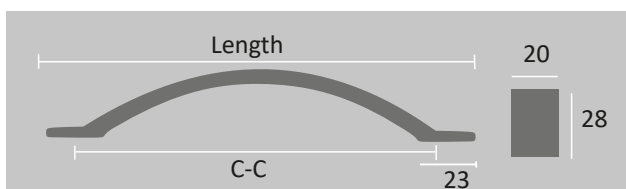

H-61228

Material: Zn-Alloy

Item No.	C-C	Length
H-61228-128BK	128	165

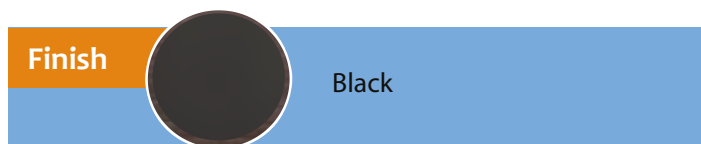

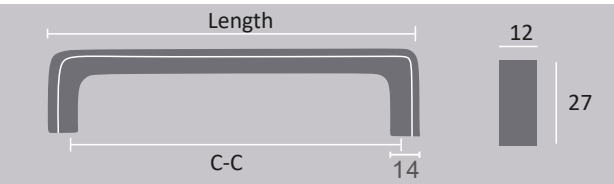

H-61364 Depressed Edge Handle - Transitional

Material: Zn-Alloy

Item No.	C-C	Length
H-61364-128MBC	128	150
H-61364-160MBC	160	176

Finish  Matte Black Chrome

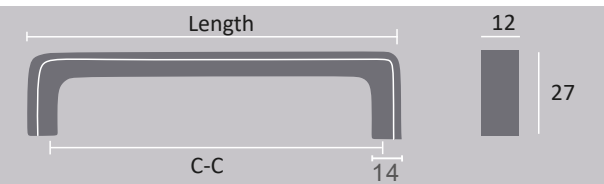

H-61364 Depressed Edge Handle - Transitional

Material: Zn-Alloy

Item No.	C-C	Length
H-61364-128BSS	128	150
H-61364-160BSS	160	176

Finish  Satin Nickel



H-61364

Material: Zn-Alloy

Item No.	C-C	Length
H-61364-160ORB	160	176

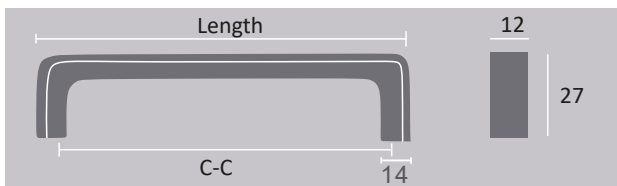

Finish



Oil Brush

handles & knobs



H-61367 Motif Handle - Modern

Material: Zn-Alloy

Item No.	C-C	Length
H-61367-128BSS	128	152
H-61367-160BSS	160	185

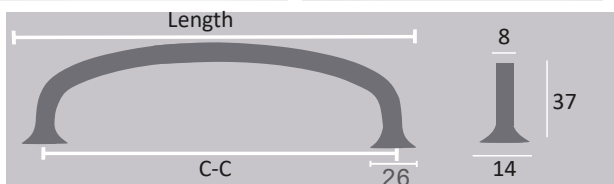

Finish



Satin Nickel

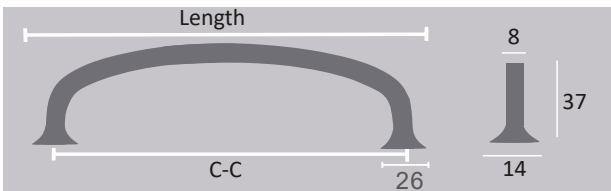

H-61367 Motif Handle - Modern

Material: Zn-Alloy

Item No.	C-C	Length
H-61367-128MBC	128	152

Finish  Matte Black Chrome

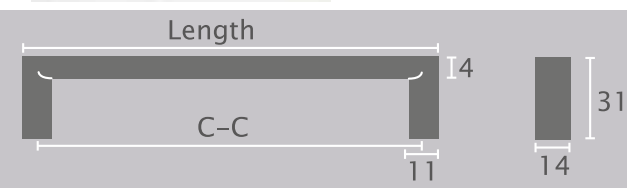

H-61415

Material: Zn-Alloy

Item No.	C-C	Length
H-61415-128BSS	128	140
H-61415-192BSS	192	205
H-61415-320BSS	320	330

Finish  Satin Nickel



H-61415

Material: Zn-Alloy

Item No.	C-C	Length
H-61415-128ORB	128	140
H-61415-192ORB	192	205
H-61415-320ORB	320	330

Finish



Oil Brush

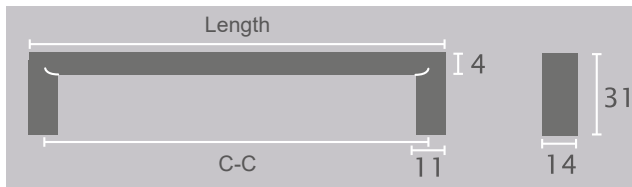

handles & knobs



H-61702 Half Pyramid Handle - Understated

Material: Zn-Alloy

Item No.	C-C	Length
H-61702-128ORB	128	138
H-61702-160ORB	160	169
H-61702-192ORB	192	201

Finish



Oil Brush

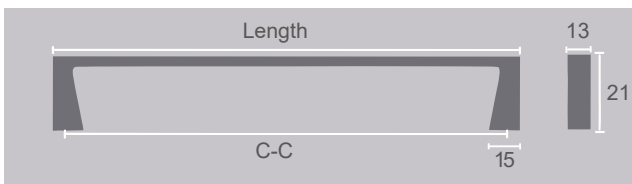

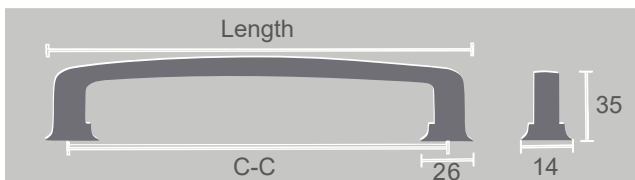

H-61704 Groove Edge Square Handle - Modern

Material: Zn-Alloy

Item No.	C-C	Length
H-61704-160CP	160	183

Finish



Chrome

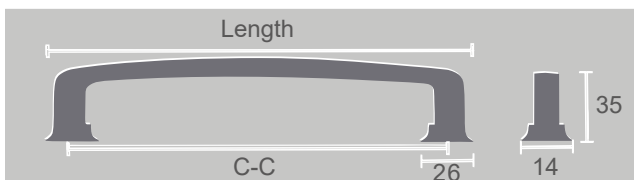

H-61704 Groove Edge Square Handle - Modern

Material: Zn-Alloy

Item No.	C-C	Length
H-61704-160SB	160	183

Finish



Rose Gold

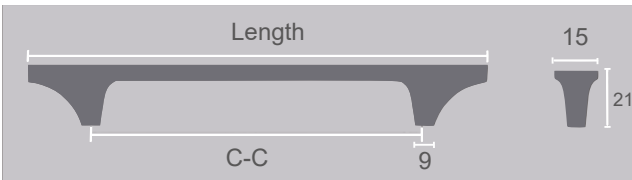

H-61708 Crystal Handle - Precious

Material: Zn-Alloy

Item No.	C-C	Length
H-61708-96CP	96	135
H-61708-128CP	128	165

Finish



Chrome

handles & knobs

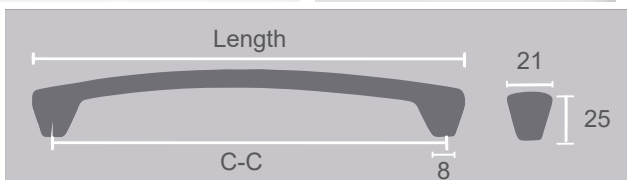

H-61710 Wide Bar Handle - Modern

Material: Zn-Alloy

Item No.	C-C	Length
H-61710-128SB	128	151

Finish



Rose Gold

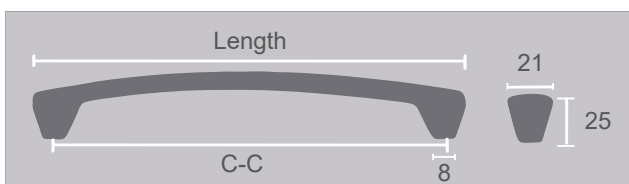

H-61710 Wide Bar Handle - Modern

Material: Zn-Alloy

Item No.	C-C	Length
H-61710-128BSS	128	151

Finish



Satin Nickel

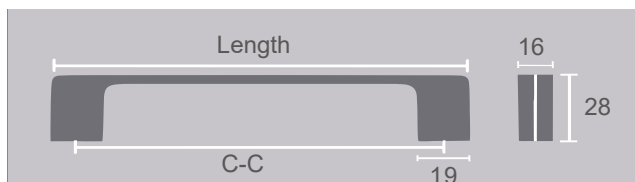
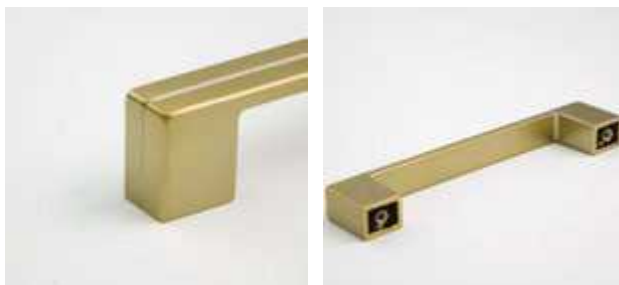

H-61712 Middle Line Handle - Modern

Material: Zn-Alloy

Item No.	C-C	Length
H-61712-128SB	128	146

Finish



Rose Gold



H-61712 Middle Line Handle - Modern

Material: Zn-Alloy

Item No.	C-C	Length
H-61712-128BSS	128	146

Finish  Satin Nickel

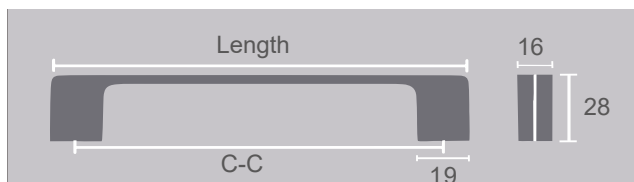

handles & knobs



H-61724

Material: Zn-Alloy

Item No.	C-C	Length
H-61724-128BK	128	140
H-61724-160BK	160	172
H-61724-224BK	224	235
H-61724-320BK	320	330

Finish  Black

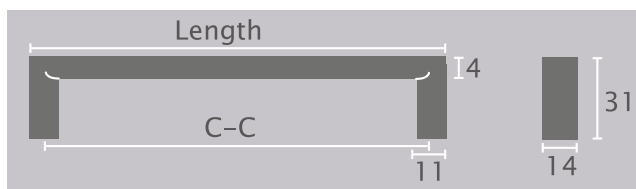

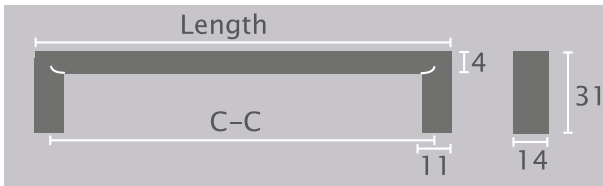

H-61724

Material: Zn-Alloy

Item No.	C-C	Length
H-61724-128BSS	128	140
H-61724-160BSS	160	172
H-61724-224BSS	224	235
H-61724-320BSS	320	330

Finish



SatinNickel

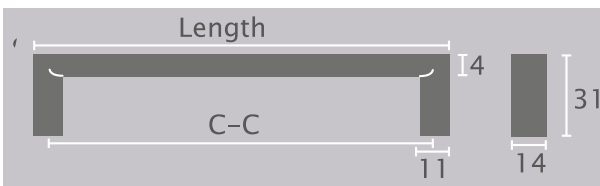

H-61724

Material: Zn-Alloy

Item No.	C-C	Length
H-61724-128CP	128	140
H-61724-160CP	160	172
H-61724-224CP	224	235
H-61724-320CP	320	330

Finish



Chrome



H-61724

Material: Zn-Alloy

Item No.	C-C	Length
H-61724-128SB	128	140
H-61724-160SB	160	172
H-61724-224SB	224	235
H-61724-320SB	320	330

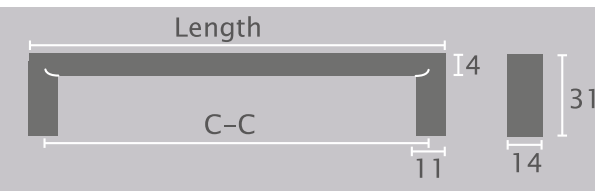

Finish  Rose Gold

handles & knobs



H-61724

Material: Zn-Alloy

Item No.	C-C	Length
H-61724-128BK	128	140
H-61724-160BK	160	172
H-61724-224BK	224	235
H-61724-320BK	320	330

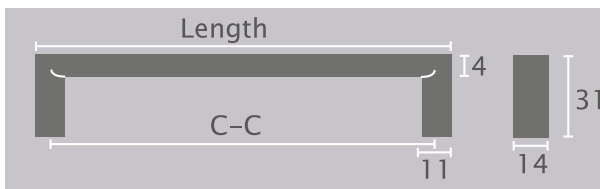

Finish  Black

handles & knobs

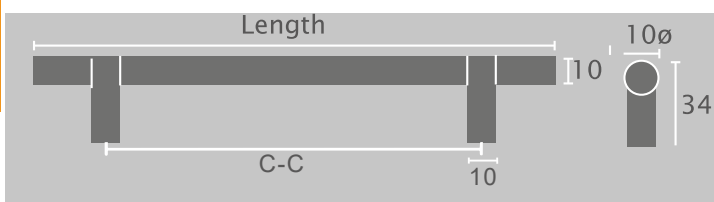

H-62027 Ring T-bar Handle-**Metropolitan**

Material: Solid Steel

Item No.	C-C	Length
H-62027-128BSS	128	166
H-62027-192BSS	192	230
H-62027-224BSS	224	262
H-62027-320BSS	320	358

Finish



SatinNickel

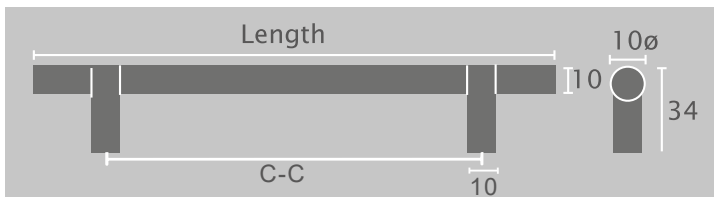

H-62027 Ring T-bar Handle-**Metropolitan**

Material: Solid Steel

Item No.	C-C	Length
H-62027-128BL	128	166
H-62027-192BL	192	230
H-62027-224BL	224	262
H-62027-320BL	320	358

Finish



Black



H-62033 Curve Underneath Handle - Everlasting

Material: Zn-Alloy

Item No.	C-C	Length
H-62033-128BSS	128	134
H-62033-192BSS	192	198
H-62033-288BSS	288	297

Finish  Satin Nickel

handles & knobs

handles & knobs

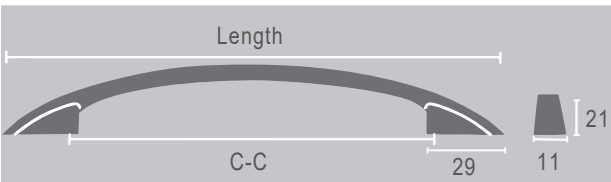

H-62052 Flipper Handle - Contemporary

Material: Zn-Alloy

Item No.	C-C	Length
H-62052-128BSS	128	170

Finish  Satin Nickel

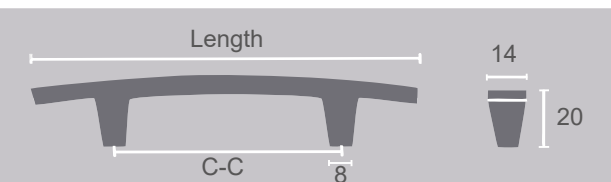

H-62075 Square T-Bar Handle - Transitional

Material: Zn-Alloy

Item No.	C-C	Length
H-62075-76ORB	76	133

Finish  Oil Brush

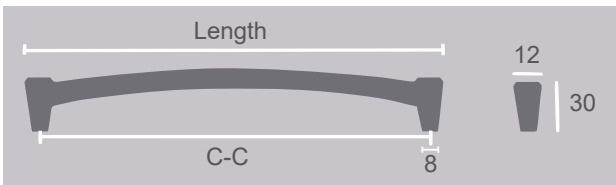

H-62158 Connection Handle - Transitional

Material: Zn-Alloy

Item No.	C-C	Length
H-62158-160BSS	160	175

Finish  Satin Nickel

handles & knobs

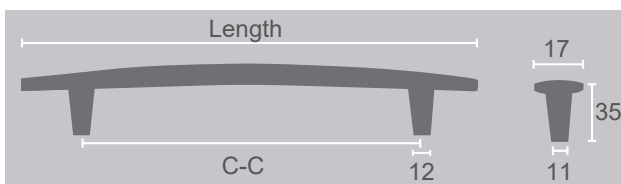

H-62219 Curve Art Handle - Modern

Material: Zn-Alloy

Item No.	C-C	Length
H-62219-128BSS	128	168
H-62219-160BSS	160	200
H-62219-320BSS	320	366

Finish  Satin Nickel

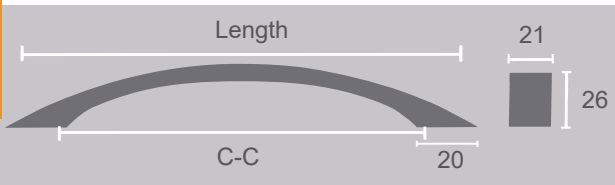

H-62346 Flair Parentheses Handle - Streamline

Material: Zn-Alloy

Item No.	C-C	Length
H-62346-160BSS	160	191

Finish



Satin Nickel

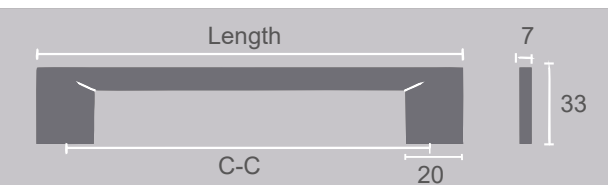

H-62356 Slim Square Bar Handle - Echo

Material: Zn-Alloy

Item No.	C-C	Length
H-62356-128BSS	128	146

Finish



Satin Nickel

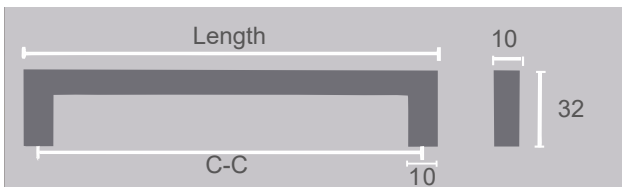

H-62501 Square Block Handle - Perfect Symmetry

Material: Zn-Alloy

Item No.	C-C	Length
H-62501-128BSS	128	136
H-62501-160BSS	160	168
H-62501-192BSS	192	200
H-62501-224BSS	224	235
H-62501-256BSS	256	265

Finish



Satin Nickel

handles & knobs



H-62501 Square Block Handle - Perfect Symmetry

Material: Zn-Alloy

Item No.	C-C	Length
H-62501-128BK	128	136
H-62501-160BK	160	168
H-62501-192BK	192	200
H-62501-224BK	224	235
H-62501-256BK	256	265

Finish



Black

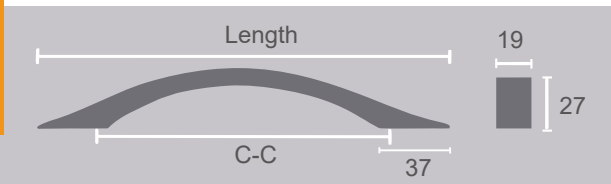

H-62670 Flair Wave Handle - Graceful

Material: Zn-Alloy

Item No.	C-C	Length
H-62670-160BSS	160	223

Finish  Satin Nickel

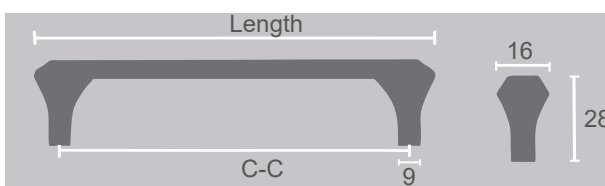

H-62862 Flair Bench Handle - Thick

Material: Zn-Alloy

Item No.	C-C	Length
H-62862-76RG	76	91

Finish  Honey Brown

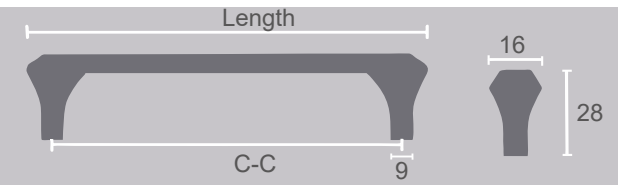

H-62862 Flair Bench Handle - Thick

Material: Zn-Alloy

Item No.	C-C	Length
H-62862-76BSS	76	91

Finish  Satin Nickel

handles & knobs

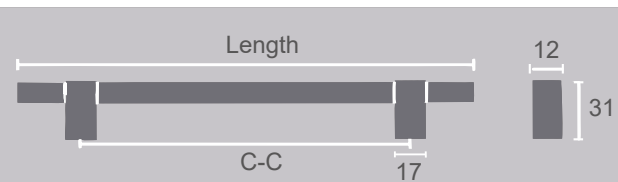

H-63119 Square T-Bar Handle - Contemporary

Material: Zn-Alloy

Item No.	C-C	Length
H-63119-128BSS	128	187
H-63119-160BSS	160	220
H-63119-224BSS	224	283
H-63119-320BSS	320	378
H-63119-416BSS	416	474

Finish  Satin Nickel

handles & knobs

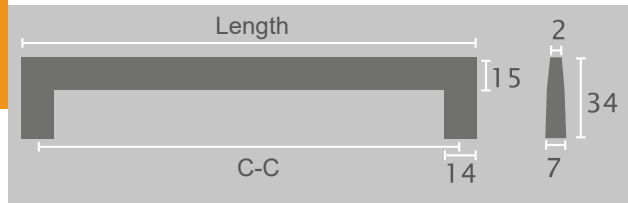
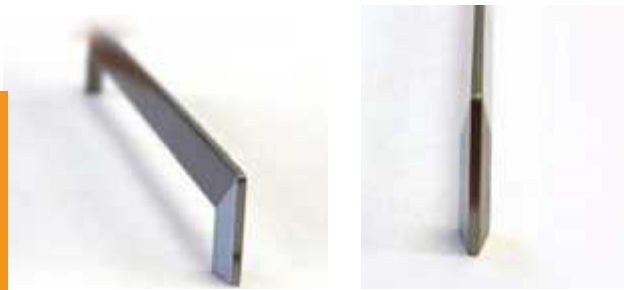

H-64203 Mitred Pyramid Handle - Dimension

Material: Zn-Alloy

Item No.	C-C	Length
H-64203-160BSS	160	182
H-64203-320BSS	320	342

Finish



Satin Nickel

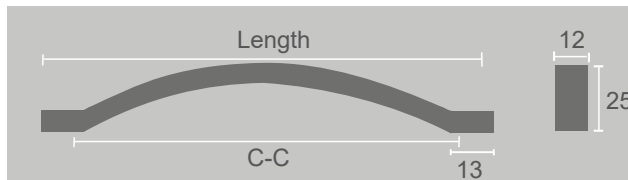

H-64510 Curve Underneath Handle - Everlasting

Material: Zn-Alloy

Item No.	C-C	Length
H-64510-160BSS	160	182
H-64510-224BSS	224	242
H-64510-352BSS	352	380

Finish



Satin Nickel

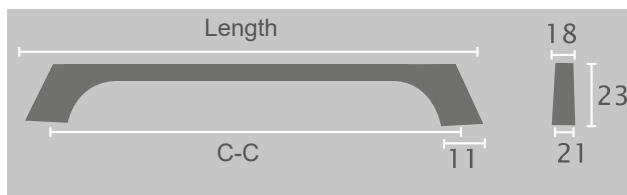

H-64520 Soft Mustache Handle - **Boldness**

Material: Zn-Alloy

Item No.	C-C	Length
H-64520-160BSS	160	170
H-64520-320BSS	320	330

Finish  Satin Nickel

handles & knobs

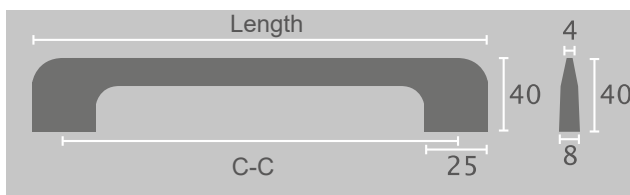

H-64978 Flair D Handle - **Effortness**

Material: Zn-Alloy

Item No.	C-C	Length
H-64978-160BSS	160	200

Finish  Satin Nickel

handles & knobs

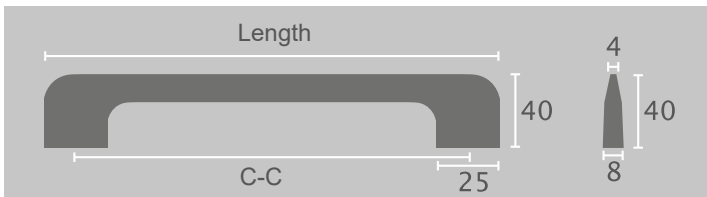

H-64978 Flair D Handle - Effortness

Material: Zn-Alloy

Item No.	C-C	Length
H-64978-160CP	160	200

Finish  Chrome

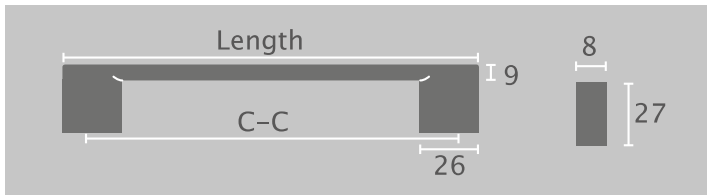

H-65013 Slim Profile Handle - Simplicity

Material: Zn-Alloy

Item No.	C-C	Length
H-65013-128BSS	128	161
H-65013-192BSS	192	225
H-65013-224BSS	224	256
H-65013-320BSS	320	354

Finish  SatinNickel



H-65013 Slim Profile Handle - *Simplicity*

Material: Zn-Alloy

Item No.	C-C	Length
H-65013-128BK	128	161
H-65013-192BK	192	225
H-65013-224BK	224	256
H-65013-320BK	320	354

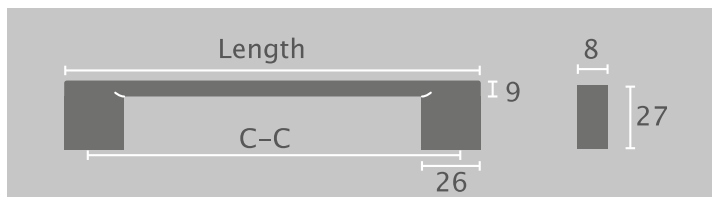

Finish  Black

handles & knobs



H-65013 Slim Profile Handle - *Simplicity*

Material: Zn-Alloy

Item No.	C-C	Length
H-65013-128RG	128	161
H-65013-192RG	192	225
H-65013-320RG	320	354

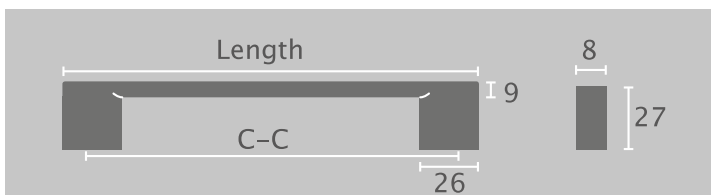

Finish  Rose Gold

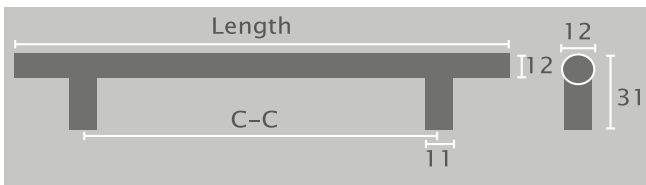

H-65040B Standard T-bar Handle- **Impact**
Material: Solid Steel

Item No.	C-C	Length
H-65040B-96BK	96	146
H-65040B-128BK	128	178
H-65040B-224BK	224	274
H-65040B-320BK	320	370

Finish  Black

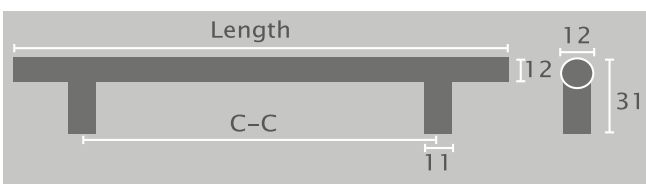

H-65040B Standard T-bar Handle- **Impact**
Material: Solid Steel

Item No.	C-C	Length
H-65040B-96GL	96	146
H-65040B-128GL	128	178
H-65040B-224GL	224	274
H-65040B-320GL	320	370

Finish  Gold

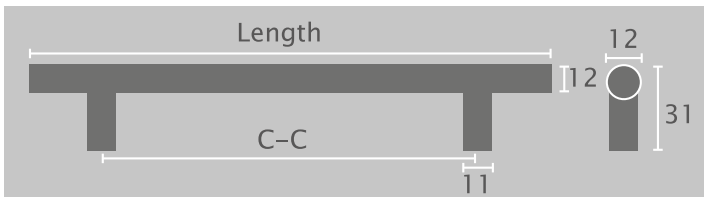

H-65040B Standard T-bar Handle- Impact

Material: Solid Steel

Item No.	C-C	Length
H-65040B-96	96	146
H-65040B-128	128	178
H-65040B-160	160	210
H-65040B-192	192	242
H-65040B-224	224	274
H-65040B-320	320	370
H-65040B-416	416	466

Finish



SatinNickel

handles & knobs



H-65212

Material: Zn-Alloy

Item No.	C-C	Length
H-65212-128BK	128	142
H-65212-160BK	160	168
H-65212-256BK	256	270

Finish



Black

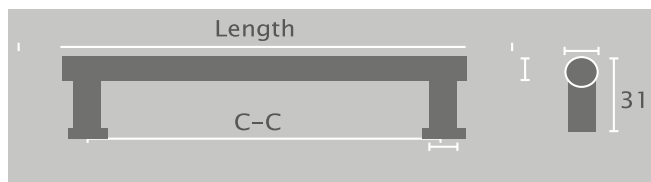

handles & knobs



H-65212

Material: Zn-Alloy

Item No.	C-C	Length
H-65212-128BSS	128	142
H-65212-160BSS	160	168
H-65212-256BSS	256	270

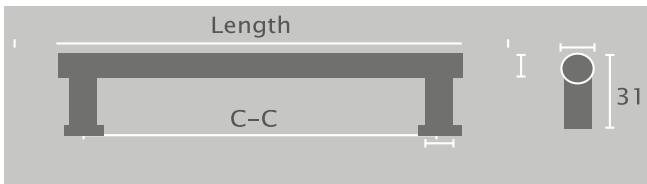

Finish



SatinNickel



H-65212

Material: Zn-Alloy

Item No.	C-C	Length
H-65212-128CP	128	142
H-65212-160CP	160	168
H-65212-256CP	256	270

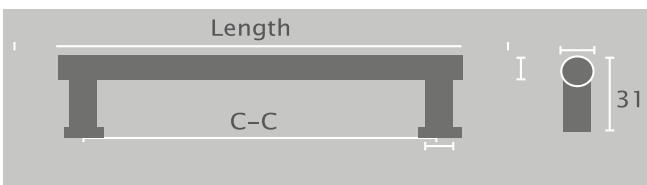

Finish



Chrome

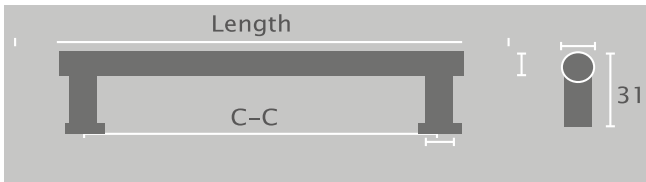

H-65212

Material: Zn-Alloy

Item No.	C-C	Length
H-65212-128RG	128	142
H-65212-160RG	160	168
H-65212-256RG	256	270

Finish

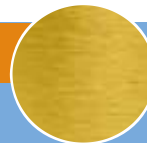

Rose Gold

handles & knobs

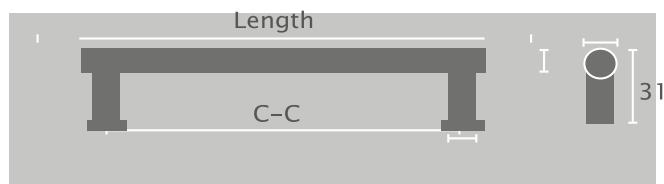

H-65212

Material: Zn-Alloy

Item No.	C-C	Length
H-65212-128PY	128	142
H-65212-160PY	160	168
H-65212-256PY	256	270

Finish



Pearl Grey

handles & knobs

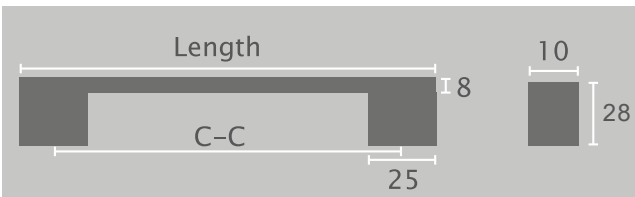

H-65355 Plank Square Handle - Modernity

Material: Zn-Alloy

Item No.	C-C	Length
H-65355-128CP	128	159

Finish



Chrome

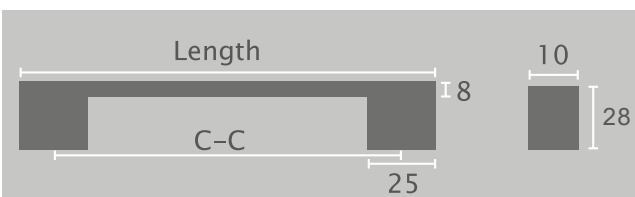

H-65355 Plank Square Handle - Modernity

Material: Zn-Alloy

Item No.	C-C	Length
H-65355-128GB	128	159

Finish



Gold

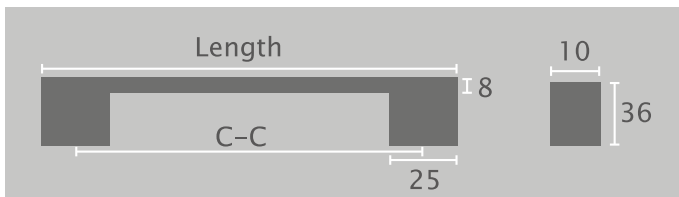

H-65355 Plank Square Handle - Modernity

Material: Zn-Alloy

Item No.	C-C	Length
H-65355-128BK	128	159
H-65355-160BK	160	191
H-65355-192BK	192	222
H-65355-224BK	224	256
H-65355-320BK	320	350

Finish



Black

handles & knobs

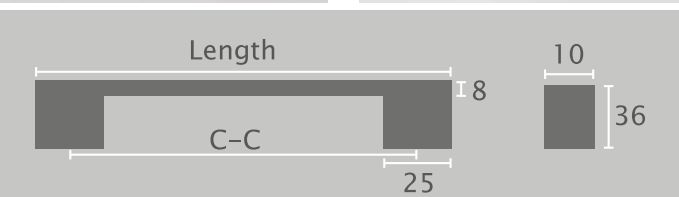

H-65355 Plank Square Handle - Modernity

Material: Zn-Alloy

Item No.	C-C	Length
H-65355-128BSS	128	159
H-65355-160BSS	160	191
H-65355-192BSS	192	222
H-65355-224BSS	224	256
H-65355-320BSS	320	350

Finish



SatinNickel

handles & knobs

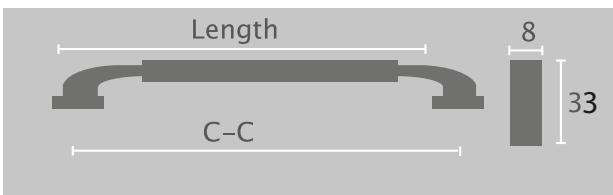

H-65458

Material: Zn-Alloy

Item No.	C-C	Length
H-65458-128BK	128	140
H-65458-192BK	192	205
H-65458-320BK	320	335

Finish



Black

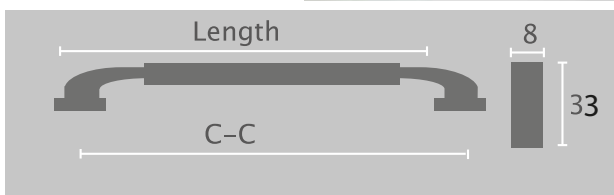

H-65458

Material: Zn-Alloy

Item No.	C-C	Length
H-65458-128BSS	128	140
H-65458-192BSS	192	205
H-65458-320BSS	320	335

Finish



Satin Nickel

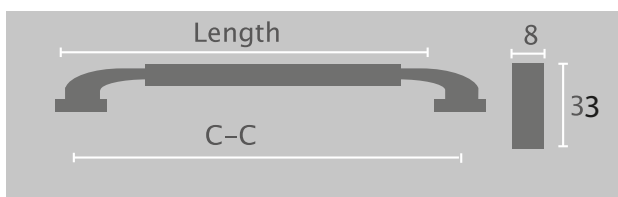

H-65458

Material: Zn-Alloy

Item No.	C-C	Length
H-65458-128CP	128	140
H-65458-192CP	192	205
H-65458-320CP	320	335

Finish



Chrome

handles & knobs

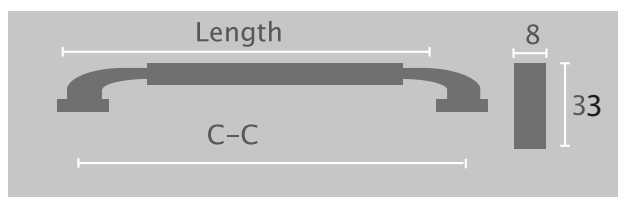

H-65458

Material: Zn-Alloy

Item No.	C-C	Length
H-65458-128PY	128	140
H-65458-192PY	192	205
H-65458-320PY	320	335

Finish



Pearl Grey

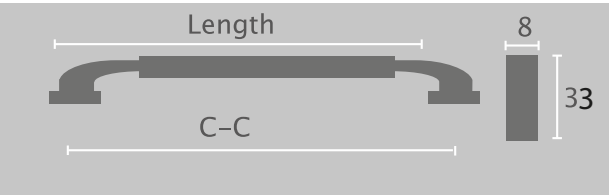

H-65458

Material: Zn-Alloy

Item No.	C-C	Length
H-65458-128RG	128	140
H-65458-192RG	192	205
H-65458-320RG	320	335

Finish

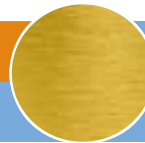

Rose Gold

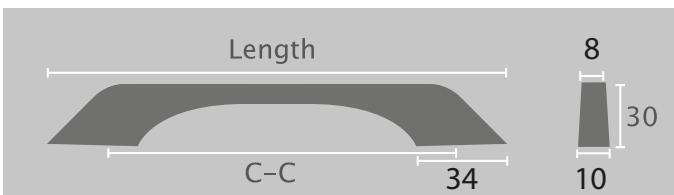

H-65717

Material: Zn-Alloy

Item No.	C-C	Length
H-65717-128BK	128	157
H-65717-160BK	160	192
H-65717-192BK	192	223
H-65717-224BK	224	257
H-65717-320BK	320	357

Finish



Black



H-65717

Material: Zn-Alloy

Item No.	C-C	Length
H-65717-128BSS	128	157
H-65717-160BSS	160	192
H-65717-192BSS	192	223
H-65717-224BSS	224	257
H-65717-320BSS	320	357

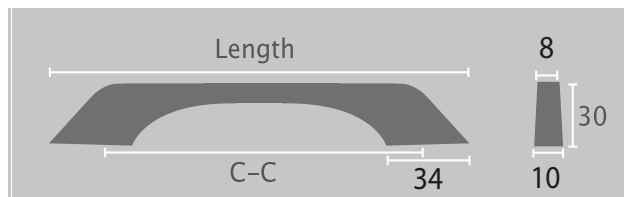

handles & knobs



H-65718

Material: Zn-Alloy

Item No.	C-C	Length
H-65718-128BK	128	192
H-65718-160BK	160	226
H-65718-192BK	192	256
H-65718-224BK	224	286
H-65718-320BK	320	382

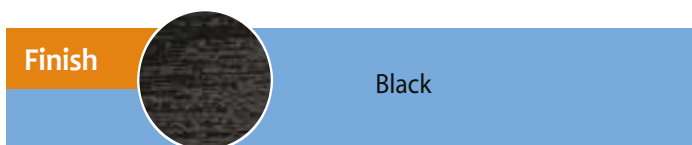
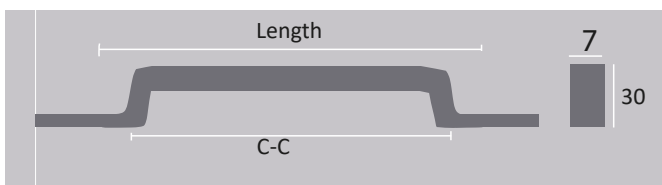

handles & knobs



H-65718

Material: Zn-Alloy

Item No.	C-C	Length
H-65718-128BSS	128	192
H-65718-160BSS	160	226
H-65718-192BSS	192	256
H-65718-224BSS	224	286
H-65718-320BSS	320	382

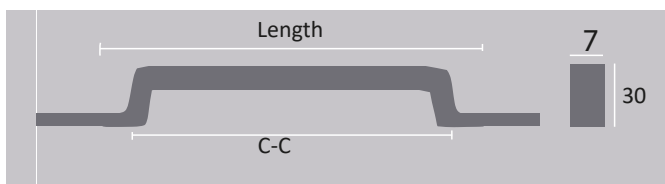

Finish



Satin Nickel



H-65804

Material: Zn-Alloy

Item No.	C-C	Length
H-65804-128BSS	128	144
H-65804-192BSS	192	208

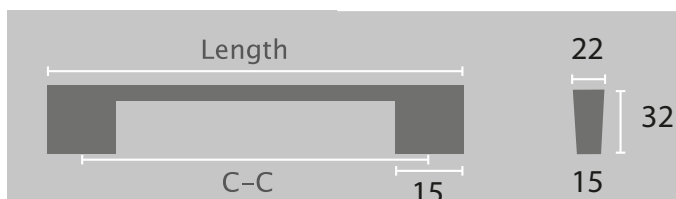

Finish



Satin Nickel

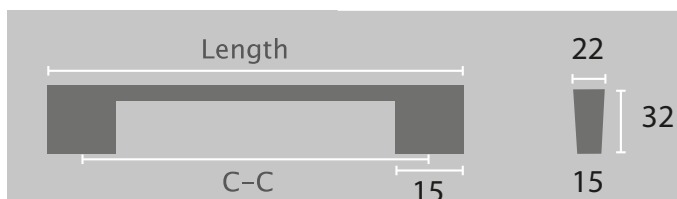

H-65804

Material: Zn-Alloy

Item No.	C-C	Length
H-65804-128BK	128	144
H-65804-192BK	192	208

Finish



Black

handles & knobs

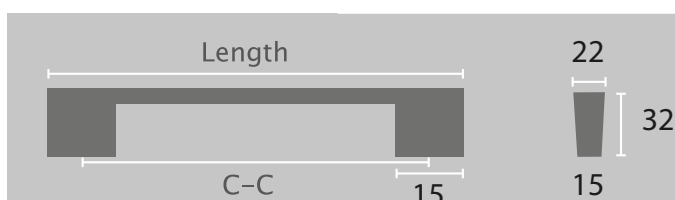

H-65804

Material: Zn-Alloy

Item No.	C-C	Length
H-65804-128CP	128	144
H-65804-192CP	192	208

Finish



Chrome



H-65804

Material: Zn-Alloy

Item No.	C-C	Length
H-65804-128GL	128	144
H-65804-192GL	192	208

Finish

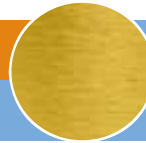

Gold

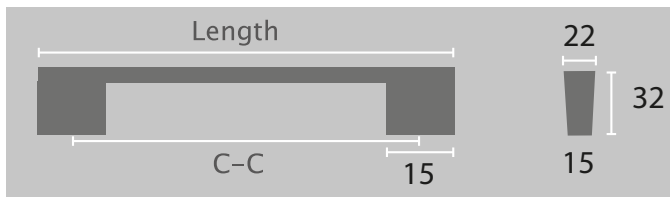

H-65815

Material: Zn-Alloy

Item No.	C-C	Length
H-65815-128BK	128	140
H-65815-192BK	192	205
H-65815-320BK	320	330

Finish



Black

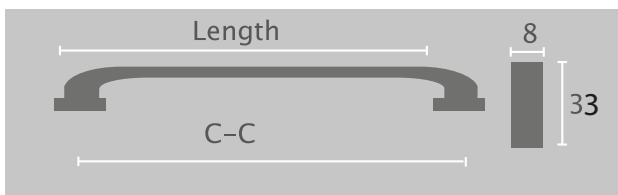

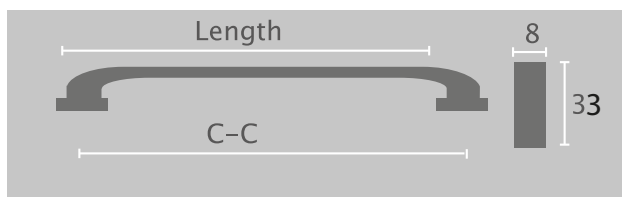

H-65815

Material: Zn-Alloy

Item No.	C-C	Length
H-65815-128BSS	128	140
H-65815-192BSS	192	205
H-65815-320BSS	320	330

Finish



Satin Nickel

handles & knobs

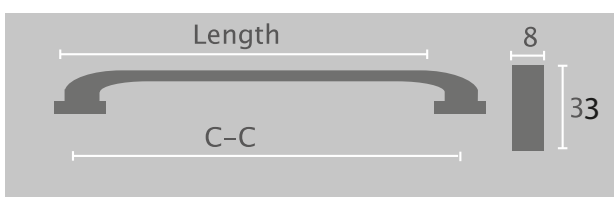

H-65815

Material: Zn-Alloy

Item No.	C-C	Length
H-65815-128CP	128	140
H-65815-192CP	192	205
H-65815-320CP	320	330

Finish



Chrome

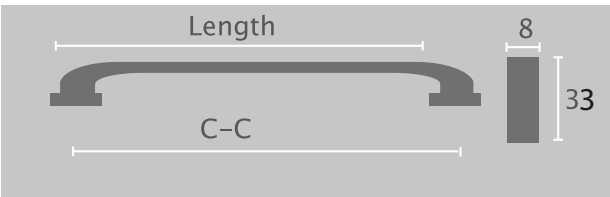

H-65815

Material: Zn-Alloy

Item No.	C-C	Length
H-65815-128RG	128	140
H-65815-192RG	192	205
H-65815-320RG	320	330

Finish

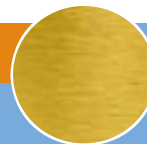

Rose Gold

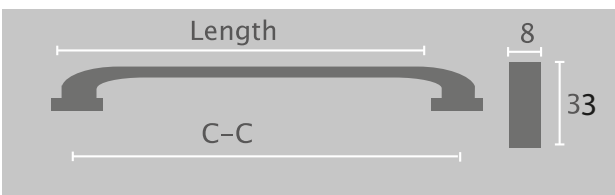

H-65815

Material: Zn-Alloy

Item No.	C-C	Length
H-65815-128PY	128	140
H-65815-192PY	192	205
H-65815-320PY	320	330

Finish



Pearl Grey

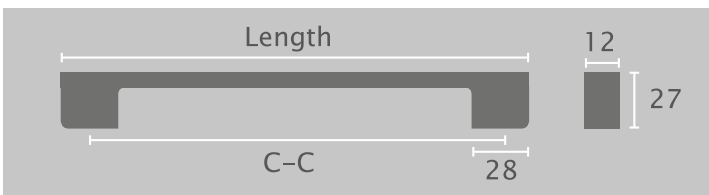

H-66723 Tapered Flat Handle - *Wondrous*

Material: Zn-Alloy

Item No.	C-C	Length
H-66723-128BSS	128	138
H-66723-192BSS	192	200
H-66723-320BSS	320	328

Finish



Satin Nickel

handles & knobs

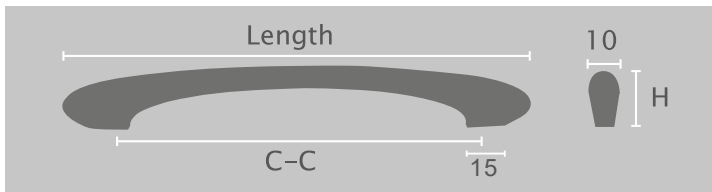

H-66732 Mercury Handle - *Orbit*

Material: Zn-Alloy

Item No.	C-C	Length	H
H-66732-160BSS	160	208	29
H-66732-192BSS	192	250	33
H-66732-256BSS	256	330	33

Finish



Satin Nickel

handles & knobs

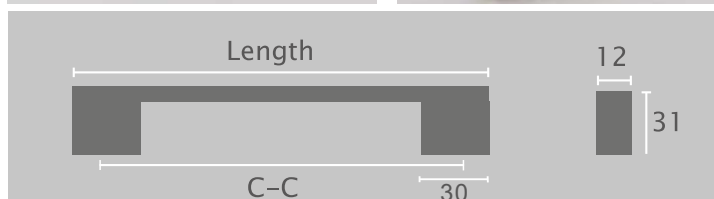

H-66749 Screw Driver Handle - Echo

Material: Zn-Alloy

Item No.	C-C	Length
H-66749-128BSS	128	155
H-66749-160BSS	160	190
H-66749-320BSS	320	350

Finish  Satin Nickel

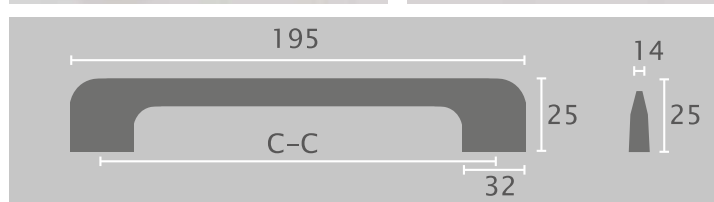

H-66750 Flair Mustache Handle - Allure

Material: Zn-Alloy

Item No.	C-C	Length
H-66750-160BSS	160	195
H-66750-320BSS	320	354

Finish  Satin Nickel

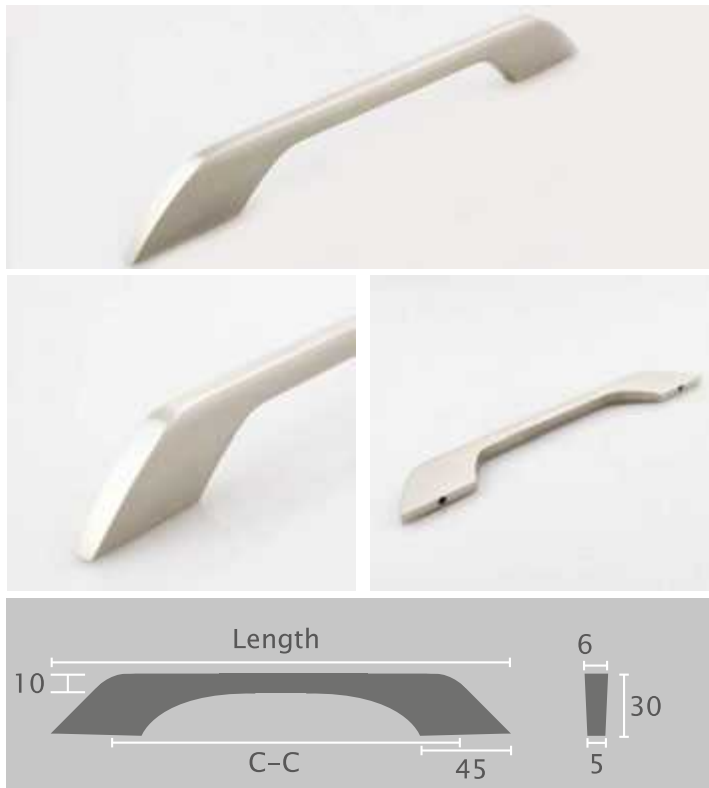

H-66751 Flair Mustache Handle - Talent

Material: Zn-Alloy

Item No.	C-C	Length
H-66751-192BSS	192	239
H-66751-320BSS	320	366

Finish



Satin Nickel

handles & knobs

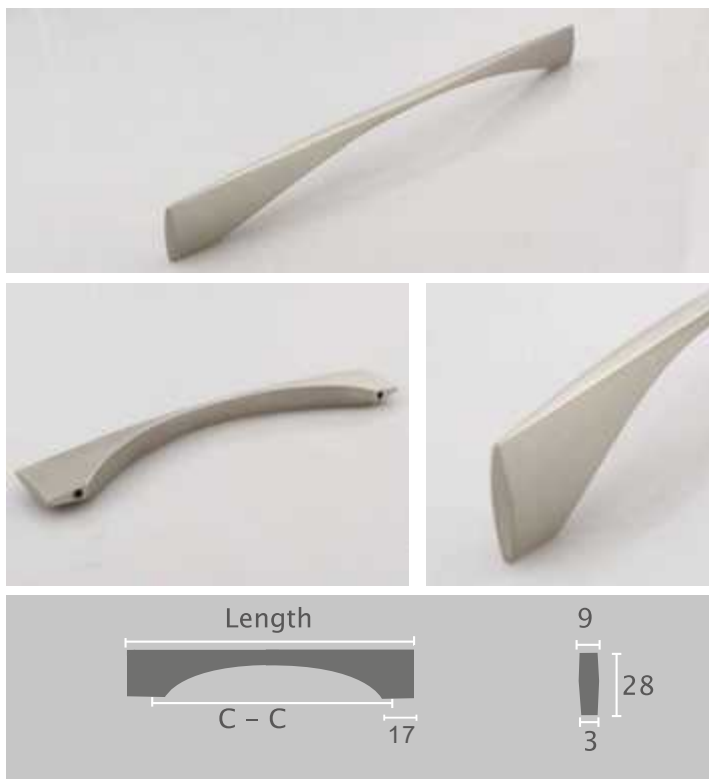

H-66796 Straight Mustache Handle - Stylish

Material: Zn-Alloy

Item No.	C-C	Length
H-66796-160BSS	160	185
H-66796-320BSS	320	360

Finish



Satin Nickel

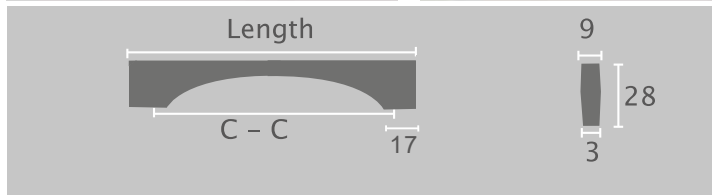

H-66796 Straight Mustache Handle - Stylish

Material: Zn-Alloy

Item No.	C-C	Length
H-66796-160CP	160	185
H-66796-320CP	320	360

Finish



Chrome

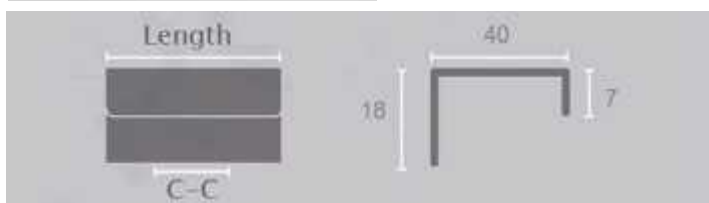

H-67894 Tab Handle - Coordinated

Material: Zn-Alloy

Item No.	C-C	Length
H-67894-40	38	40
H-67894-136	128	136
H-67894-168	160	168
H-67894-286	256	286
H-67894-400	320	400
H-67894-600	480	600

Finish



Satin Nickel



H-71106 Curve underneath Handle - Everlasting

Material: Zn-Alloy

Item No.	C-C	Length
H-71106-128BSS	128	134
H-71106-160BSS	160	168
H-71106-224BSS	224	232

Finish



Satin Nickel

handles & knobs

handles & knobs

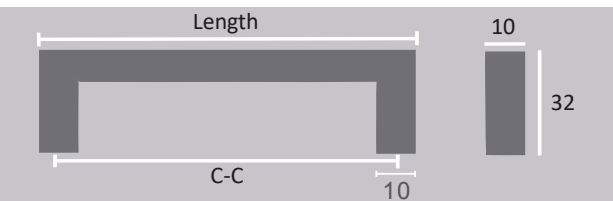

H-71107 Curve Underneath Handle - Everlasting

Material: Zn-Alloy

Item No.	C-C	Length
H-71107-128MBC	128	138

Finish

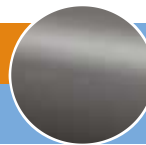

Matte Black Chrome

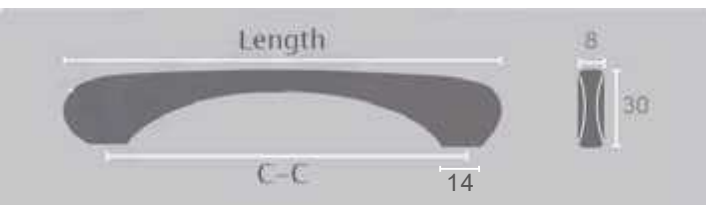

H-71260 Wishbone Handle - Petal

Material: Zn-Alloy

Item No.	C-C	Length
H-71260-160CP	160	195
H-71260-224CP	224	267

Finish



Chrome

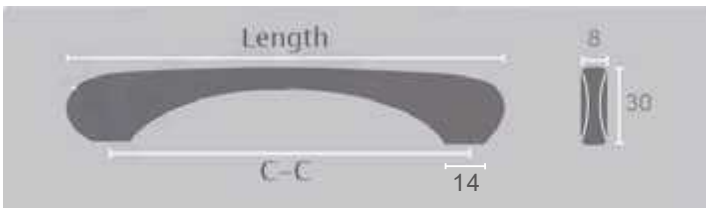

H-71260 Wishbone Handle - Petal

Material: Zn-Alloy

Item No.	C-C	Length
H-71260-128BSS	128	165
H-71260-160BSS	160	195
H-71260-224BSS	224	267

Finish



Satin Nickel

handles & knobs

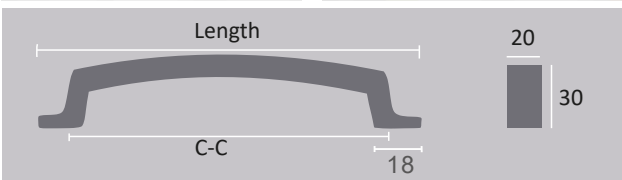

H-71267 Double L Handle - Contemporary

Material: Zn-Alloy

Item No.	C-C	Length
H-71267-128CP	128	152

Finish



Chrome

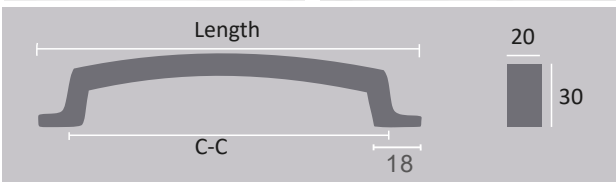

H-71267 Double L Handle - Contemporary

Material: Zn-Alloy

Item No.	C-C	Length
H-71267-128BSS	128	152

Finish



Satin Nickel

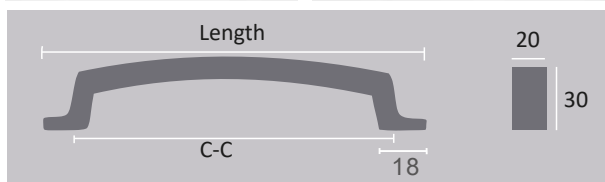

H-71267 Double L Handle - Contemporary

Material: Zn-Alloy

Item No.	C-C	Length
H-71267-128MB	128	152

Finish



Matt Black



H-71461 New Classic

Material: Zn-Alloy

Item No.	C-C	Length	Color
H-71461-128CP/W	128	157	White

Finish



Chrome

handles & knobs

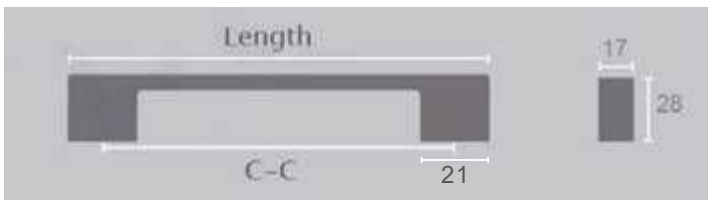

H-71461 New Classic

Material: Zn-Alloy

Item No.	C-C	Length	Color
H-71461-128CP/MN	128	157	Champagne

Finish



Chrome



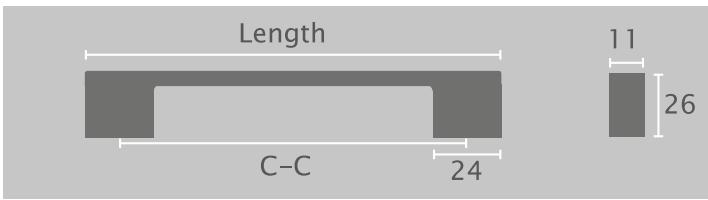

H-71530 Strip Line Handle - Always Right

Material: Zn-Alloy / ABS

Item No.	C-C	Length	Strip Colour
H-71530 -128BSS/W	128	165	White
H-71530 -128BSS/B	128	165	Black

Finish  Satin Nickel

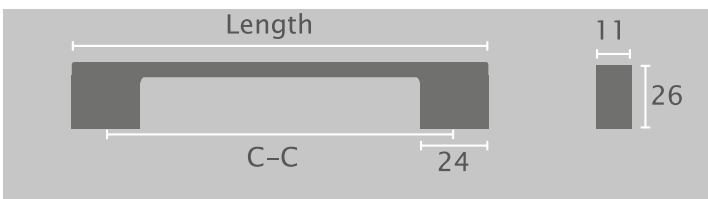
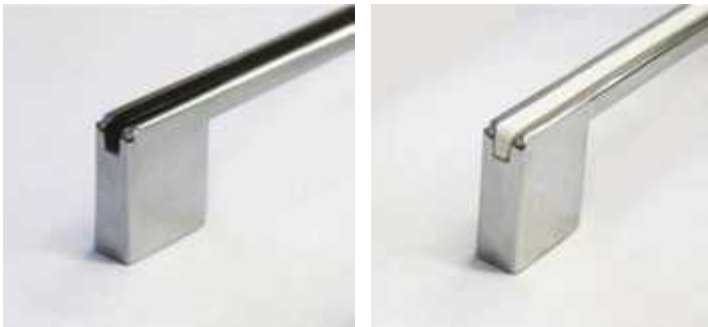
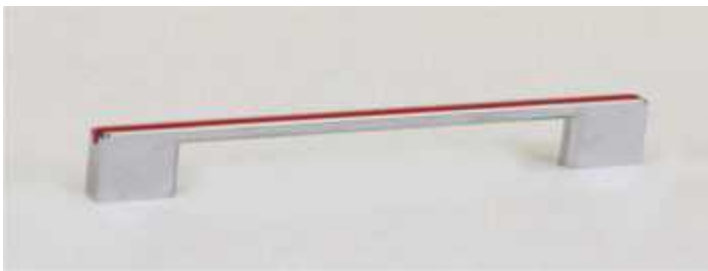

H-71530 Strip Line Handle - Always Right

Material: Zn-Alloy / ABS

Item No.	C-C	Length	Strip Colour
H-71530 -128CP/W	128	165	White
H-71530 -128CP/B	128	165	Black
H-71530 -128CP/R	128	165	Red

Finish  Chrome

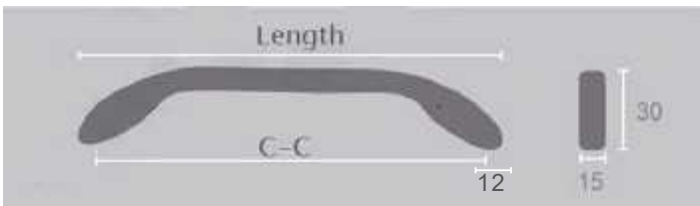

H-71632 Gondola Handle - Flourish

Material: Zn-Alloy

Item No.	C-C	Length
H-71632-128BSS	128	145

Finish



Satin Nickel

handles & knobs

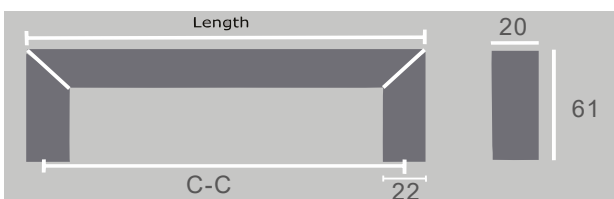

H-71726 Lace-Corner Square Handle

Material: Zn-Alloy

Item No.	C-C	Length
H-71726-160BK	160	176
H-71726-224BK	224	242
H-71726-320BK	320	338

Finish



Matt Black

handles & knobs

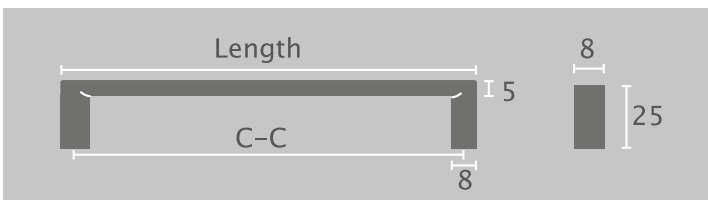

H-71808 Slim Profile Handle - Element

Material: Zn-Alloy

Item No.	C-C	Length
H-71808-128BSS	128	135
H-71808-160BSS	160	167
H-71808-224BSS	224	231
H-71808-320BSS	320	327

Finish



Satin Nickel

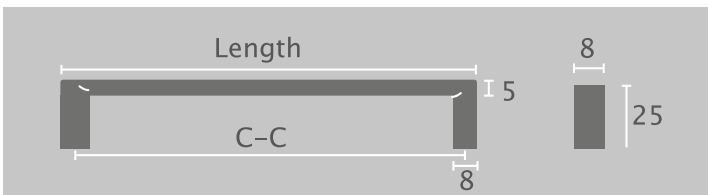

H-71808 Slim Profile Handle - Element

Material: Zn-Alloy

Item No.	C-C	Length
H-71808-128CP	128	135
H-71808-160CP	160	167
H-71808-224CP	224	231
H-71808-320CP	320	327

Finish



Chrome

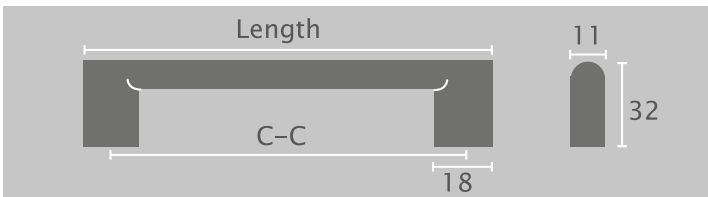

H-71852 Oval Bar Handle - Prestige

Material: Zn-Alloy

Item No.	C-C	Length
H-71852-128BSS	128	144
H-71852-160BSS	160	178
H-71852-224BSS	224	241

Finish  Satin Nickel

handles & knobs

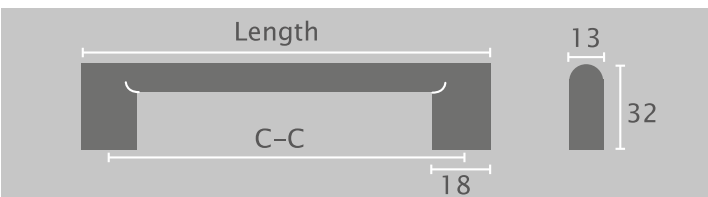

H-71852 Oval Bar Handle - Prestige

Material: Zn-Alloy

Item No.	C-C	Length
H-71852-128CP	128	144
H-71852-160CP	160	178
H-71852-224CP	224	241

Finish  Chrome

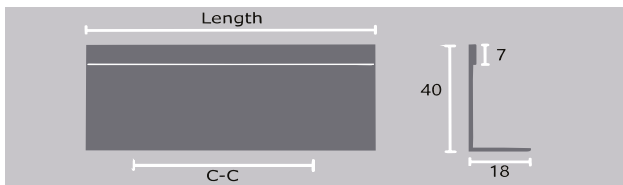

H-71989 Tab Handle - Coordinated

Material: Zn-Alloy

Item No.	C-C	Length
H-71989-50BSS	50	70
H-71989-64BSS	64	84
H-71989-80BSS	80	100
H-71989-128BSS	128	148
H-71989-192BSS	192	212
H-71989-320BSS	320	340
H-71989-416BSS	416	435

Finish



Satin Nickel

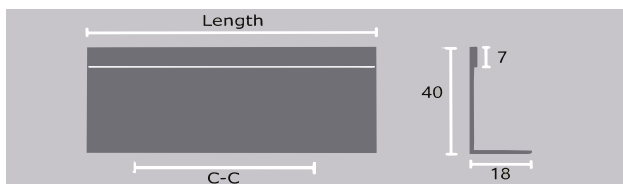
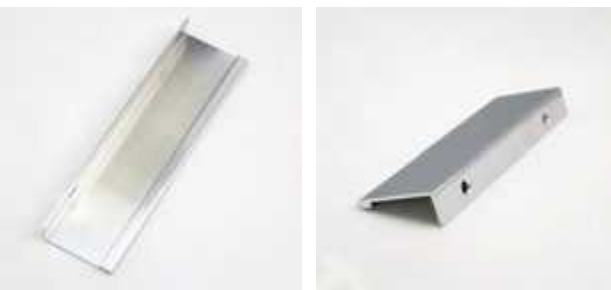

H-71989 Tab Handle - Coordinated

Material: Zn-Alloy

Item No.	C-C	Length
H-71989-152CP	96	152

Finish



Chrome

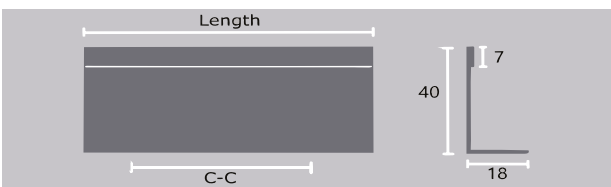

H-71989 Tab Handle - Coordinated

Material: Zn-Alloy

Item No.	C-C	Length
H-71989-50ALA	50	70
H-71989-80ALA	80	100
H-71989-96ALA	96	116
H-71989-192ALA	192	212
H-71989-416ALA	416	435

Finish

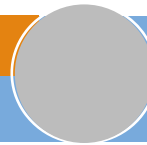

Aluminum

handles & knobs

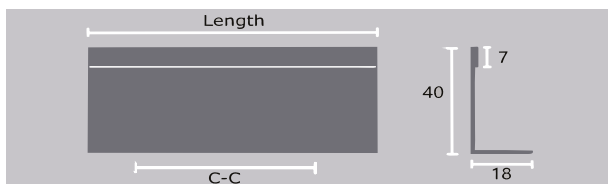

H-71989 Tab Handle - Coordinated

Material: Zn-Alloy

Item No.	C-C	Length
H-71989-50BBA	50	70
H-71989-80BBA	80	100
H-71989-128BBA	128	148
H-71989-192BBA	192	212
H-71989-320BBA	320	340
H-71989-416BBA	416	435

Finish



Brush Black



H-71989 Tab Handle - Coordinated

Material: Zn-Alloy

Item No.	C-C	Length
H-71989-50BGA	50	70
H-71989-80BGA	80	100
H-71989-192BGA	192	212
H-71989-320BGA	320	340

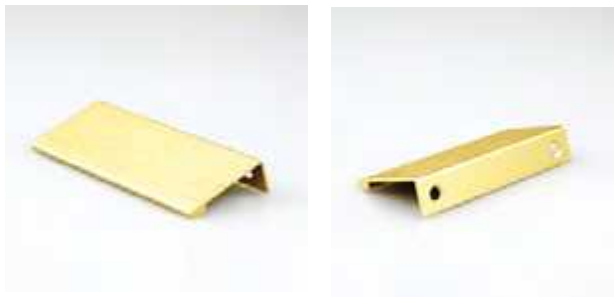

Finish  **Brush Gold**

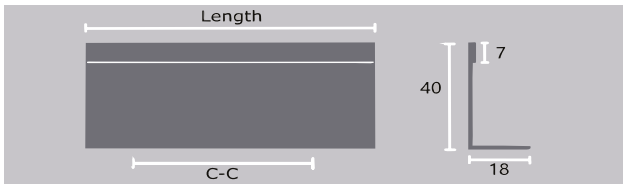

handles & knobs

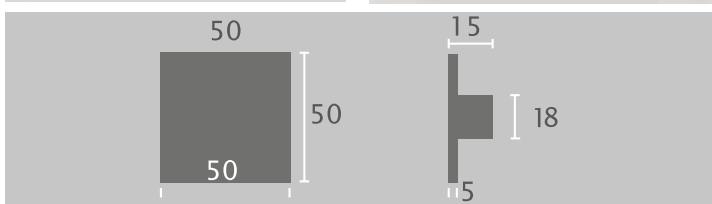

K-023 Square Pull - Idealistic

Material: Zn-Alloy

Item No.	H	Length
K-023BSS	15	50

Finish	Image	Finish Name
		Satin Nickel

handles & knobs

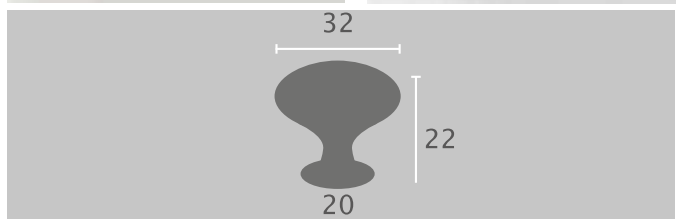

K-073 Mushroom Knob - Illustration

Material: Steel

Item No.	H	Ø
K-073BN	22	32

Finish	Image	Finish Name
		Black Nickel

handles & knobs

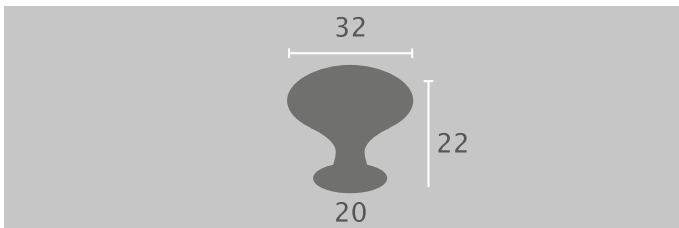

K-073 Mushroom Knob - Illustration

Material: Steel

Item No.	H	Ø
K-073BSS	22	32
Finish	 Satin Nickel	

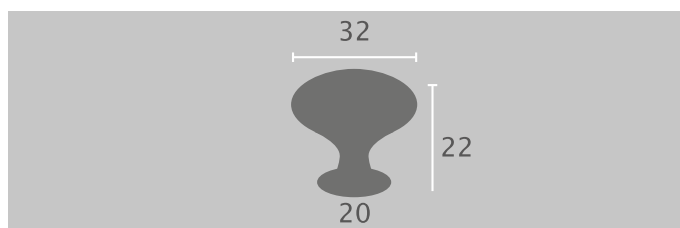

K-073 Mushroom Knob - Illustration

Material: Steel

Item No.	H	Ø
K-073CP	22	32
Finish	 Chrome	

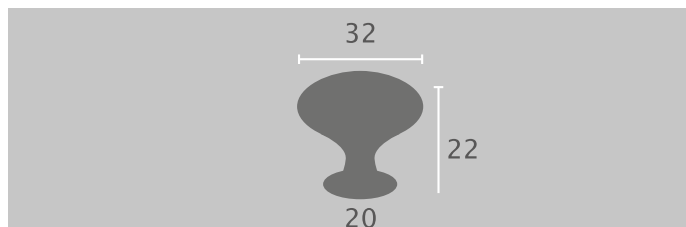

K-073 Mushroom Knob - Illustration

Material: Steel

Item No.	H	Ø
K-073BK	22	32

Finish



Matt Black

handles & knobs

handles & knobs

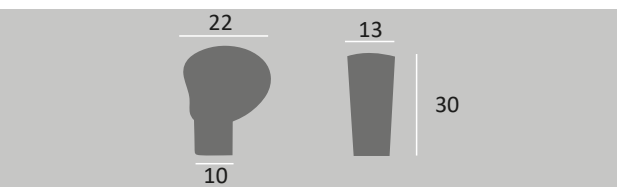

K-091 Swirl Pattern Knob - Swirl'z

Material: Zn-Alloy

Item No.	H	L
K-091BSS	30	22

Finish  Satin Nickel

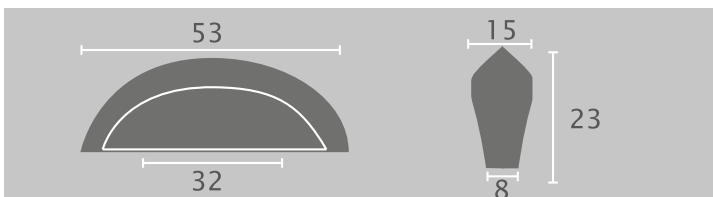

K-095 Half Moon Knob - Cosy

Material: Zn-Alloy

Item No.	C-C	Length
K-095	32	53

Finish  Satin Nickel

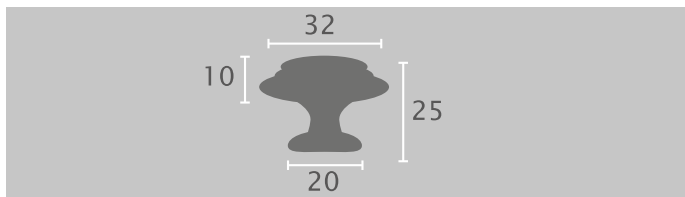

K-179 Antique Classic Ring Knob - Exotic

Material: Zn-Alloy

Item No.	H	D
K-179BK	25	32

Finish  Matt Black

handles & knobs

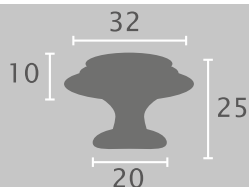

K-179 Antique Classic Ring Knob - Exotic

Material: Zn-Alloy

Item No.	H	D
K-179AI	25	32
Finish	 Antique Silver	

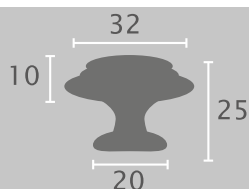

K-179 Antique Classic Ring Knob - Exotic

Material: Zn-Alloy

Item No.	H	D
K-179BSS	25	32
Finish	 Satin Nickel	

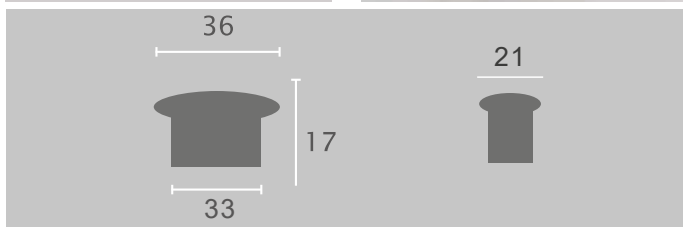

K-226 Oval Knob - Opera

Material: Steel

Item No.	H	Length
K-226BSS	17	36

Finish  Satin Nickel

handles & knobs

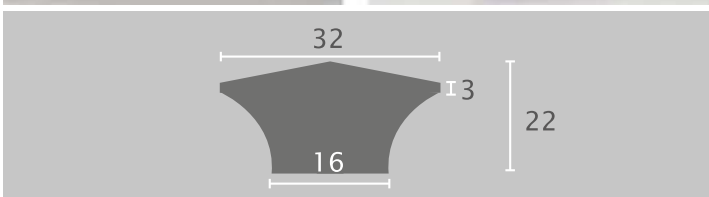
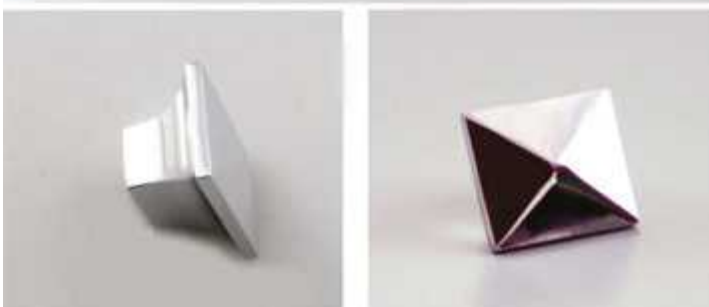

K-264 Square Pyramid Knob - Dazzle

Material: Zn-Alloy

Item No.	W	L
K-264CP	32	32

Finish  Chrome



K-264 Square Pyramid Knob - **Dazzle**

Material: Zn-Alloy

Item No.	W	L	
K-264BSS	32	32	
Finish	 Satin Nickel		

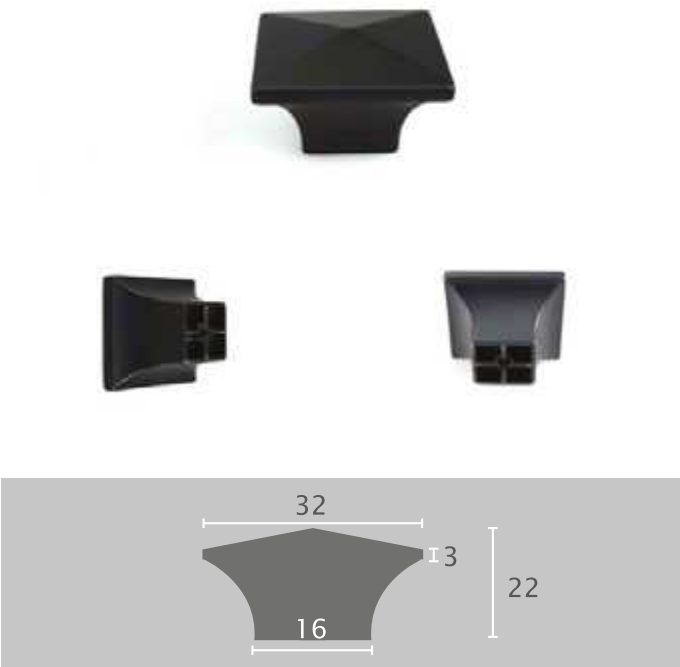

K-264 Square Pyramid Knob - **Dazzle**

Material: Zn-Alloy

Item No.	W	L	
K-264BK	32	32	
Finish	 Satin Nickel		

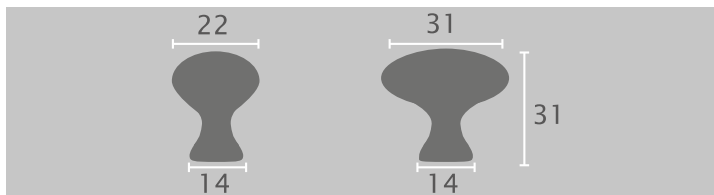

K-318 Football Knob - Enhanced

Material: Zn-Alloy

Item No.	H	Length
K-318	31	31
Finish	 Satin Nickel	

handles & knobs



K-323 Rectangle Knob - Perfection

Material: Steel

Item No.	H	Length
K-323ORB	27	37
Finish	 Oil Brush	



K-323 Rectangle Knob - Perfection

Material: Steel

Item No.	H	Length
K-323AIH	27	37
Finish	 Antique Oil Filter	



K-325 Button Ring Knob - Buzz

Material: Zn-Alloy

Item No.	H	D
K-325	24	31

Finish	
	Satin Nickel

handles & knobs



K-326 Diagonal Pattern Knob - Symphony

Material: Zn-Alloy

Item No.	H	D
K-326ORB	24	31

Finish	
	Oil Brush

handles & knobs

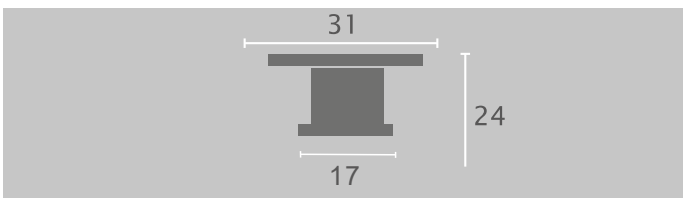

K-326 Diagonal Pattern Knob - *Symphony*

Material: Zn-Alloy

Item No.	H	D
K-326AIH	24	31

Finish
 Antique Oil Pilter

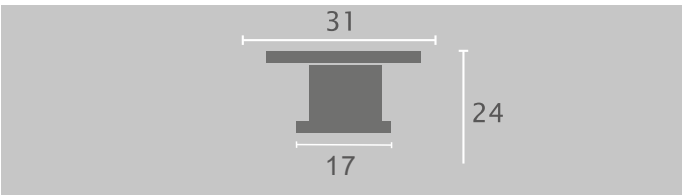

K-354 Pattern Knob - *Dramatic*

Material: Zn-Alloy

Item No.	H	D
K-354ORB	24	31

Finish
 Oil Brush



K-354 Pattern Knob - *Dramatic*

Material: Zn-Alloy

Item No.	H	D
K-354AIH	24	31

Finish	
	Antique Oil Pilter

handles & knobs



K-358 Wave Pattern Knob - *Sophisticated*

Material: Zn-Alloy

Item No.	H	D
K-358ORB	24	31

Finish	
	Oil Brush

handles & knobs

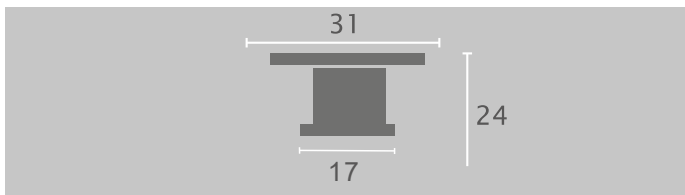

K-358 Wave Pattern Knob - *Sophisticated*

Material: Zn-Alloy

Item No.	H	D
K-358AIH	24	31

Finish  **Antique Oil Pilter**

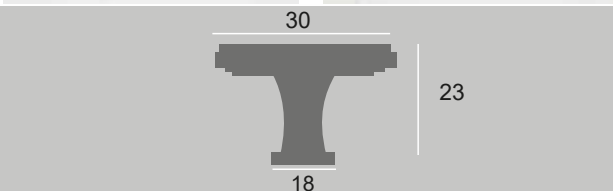

K-360 Square Knob- *Modern*

Material: Zn-Alloy

Item No.	H	L
K-360BSS	23	30

Finish  **Satin Nickel**

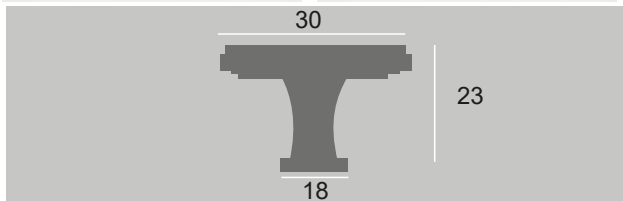

K-360 Square Knob- Modern

Material: Zn-Alloy

Item No.	H	L
K-360AI	23	30

Finish



Antique Silver

handles & knobs

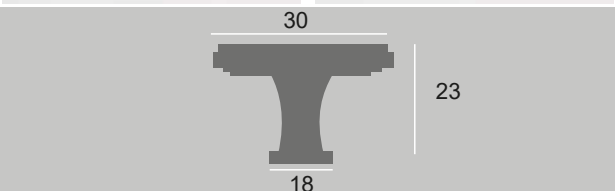

K-360 Square Knob- Modern

Material: Zn-Alloy

Item No.	H	L
K-360AS	23	30

Finish

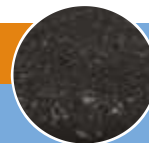

Antique Black

handles & knobs

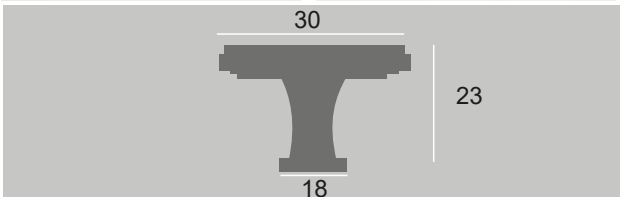

K-360 Square Knob- Modern

Material: Zn-Alloy

Item No.	H	L
K-360BK	23	30

Finish  **Matt Black**

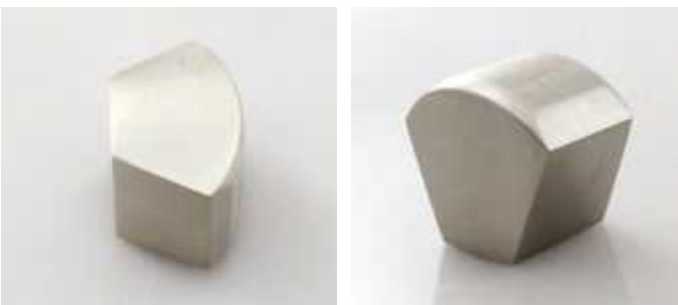

K-382 Fan Knob - Fancy

Material: Zn-Alloy

Item No.	Height	Length
K-382BSS	20	40

Finish  **Satin Nickel**

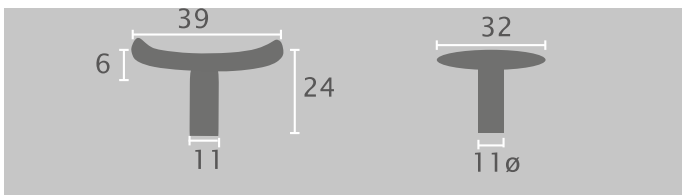

K-388 Smily Knob - Imagination

Material: Zn-Alloy

Item No.	H	D
K-388BSS	24	39

Finish	Image	Finish Name
		Satin Nickel

handles & knobs

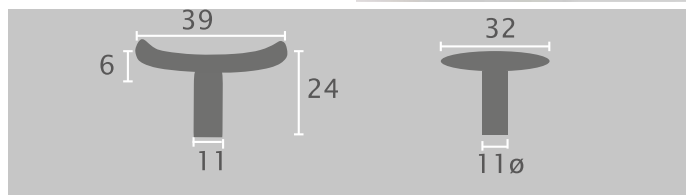

K-388 Smily Knob - Imagination

Material: Zn-Alloy

Item No.	H	D
K-388CP	24	39

Finish	Image	Finish Name
		Chrome

handles & knobs

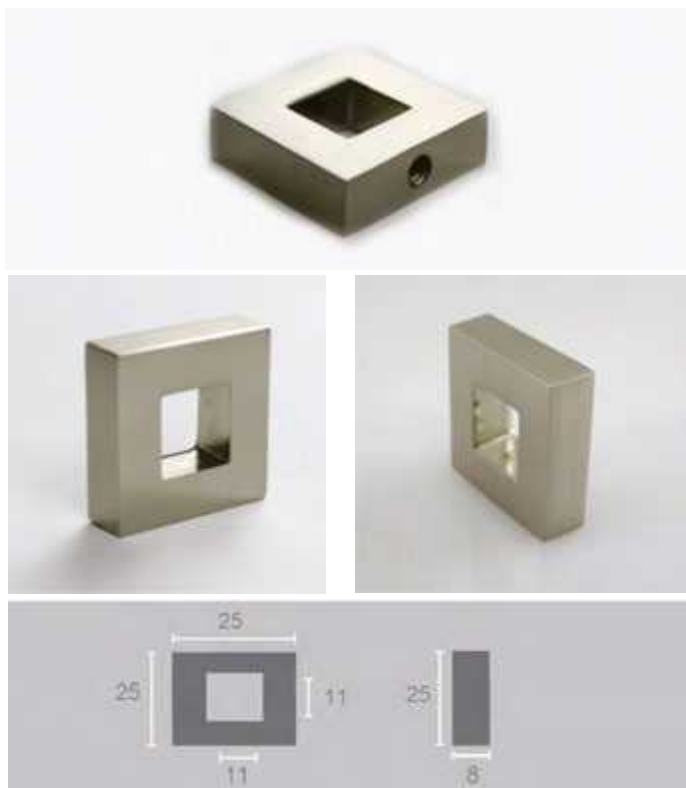

K-414 Square Ring Knob - Simplicity

Material: Zn-Alloy

Item No.	Height	Length
K-414	25	25

Finish	Image	Finish Name
		Satin Nickel



K-417 Rectangle Knob - *Luxury*

Material: Zn-Alloy

Item No.	H	D
K-417BSS	18	37

Finish	Image	Finish Name
		Satin Nickel

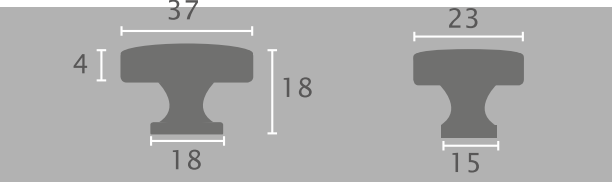

K-417 Rectangle Knob - Luxury

Material: Zn-Alloy

Item No.	H	L
K-417SB	18	37

Finish	
	Rose Gold

handles & knobs

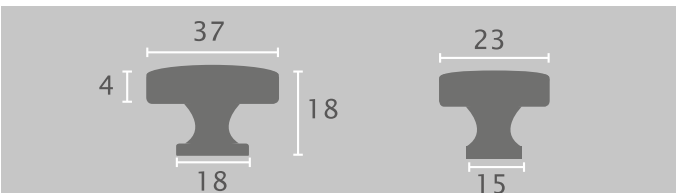

K-417 Rectangle Knob - Luxury

Material: Zn-Alloy

Item No.	H	D
K-417CP	18	37

Finish	
	Chrome



handles & knobs

K-417 Rectangle Knob - **Luxury**

Material: Zn-Alloy

Item No.	H	L
K-417BK	18	37

Finish		Black
--------	---	-------

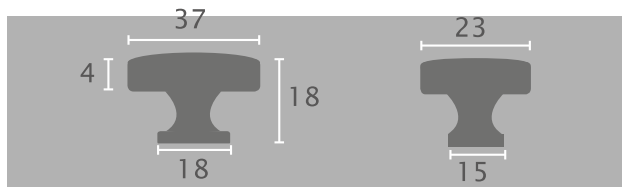

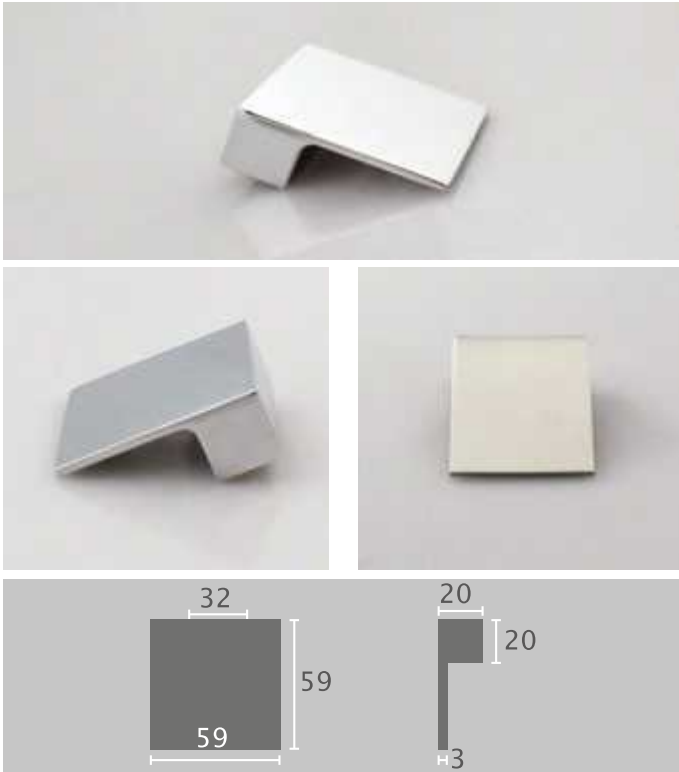

K-419 Square Finger Pull - **Brillant**

Material: Zn-Alloy

Item No.	C-C	Length
K-419CP	32	59
Finish	 Chrome	

handles & knobs

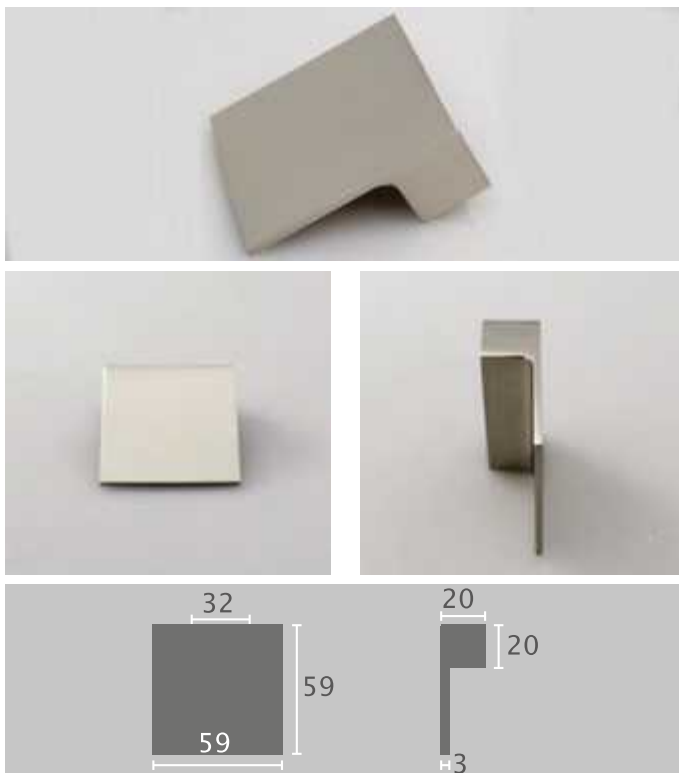

K-419 Square Finger Pull - **Brillant**

Material: Zn-Alloy

Item No.	C-C	Length
K-419BSS	32	59
Finish	 Satin Nickel	

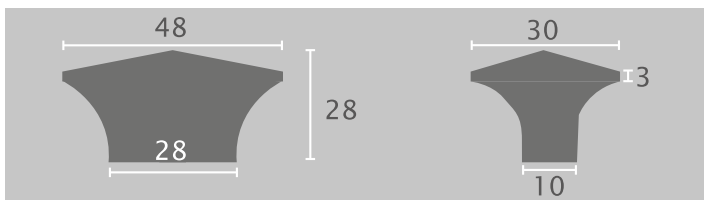

K-420 Rectangle Pyramid Knob - Reflection

Material: Zn-Alloy

Item No.	W	Length
K-420CP	30	48
Finish	Chrome	

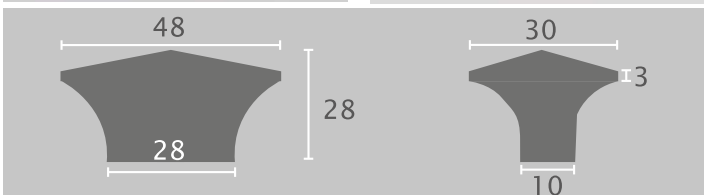

K-420 Rectangle Pyramid Knob - Reflection

Material: Zn-Alloy

Item No.	W	Length
K-420BSS	30	48
Finish	Satin Nickel	

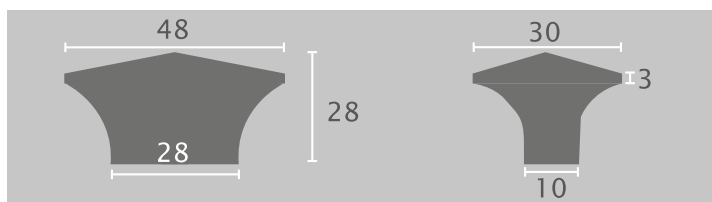

K-420 Rectangle Pyramid Knob - Reflection

Material: Zn-Alloy

Item No.	W	Length
K-420BK	30	48
Finish	Black	



handles & knobs

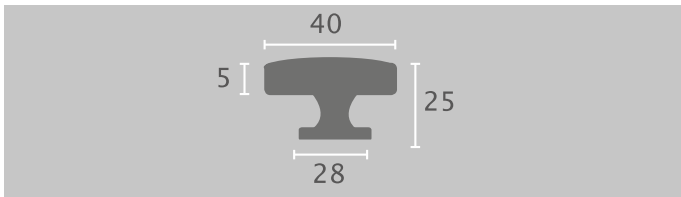

K-581 Square Knob - **Vibrant**

Material: Zn-Alloy

Item No.	H	D
K-581PC	32	40

Finish	Image	Material
Chrome		Chrome

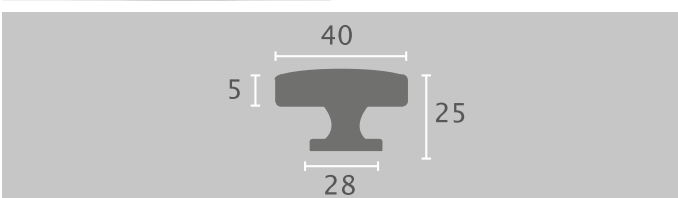

K-581 Square Knob - **Virbant**

Material: Zn-Alloy

Item No.	H	D
K-581BSS	32	40

Finish	Image	Material
Satin Nickel		Satin Nickel



K-61159 Rectangle Knob - Whimsical

Material: Zn-Alloy

Item No.	W	Length
K-61159PC	25	38
Finish	 Chrome	

handles & knobs



K-61159 Rectangle Knob - Whimsical

Material: Zn-Alloy

Item No.	W	Length
K-61159BSS	25	38
Finish	 Satin Nickel	

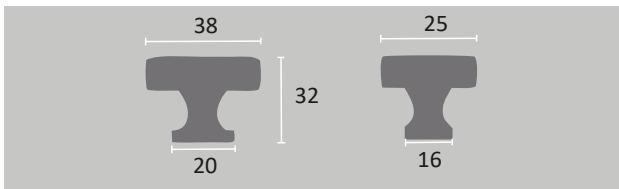

K-61159 Rectangle Knob - Whimsical

Material: Zn-Alloy

Item No.	W	Length
K-61159BK	25	38
Finish	Black	

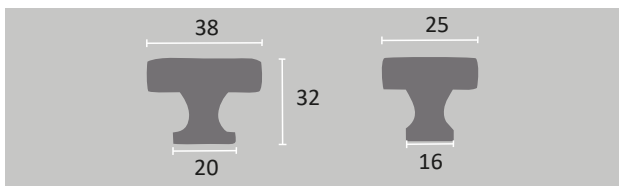

K-61159 Rectangle Knob - Whimsical

Material: Zn-Alloy

Item No.	W	Length
K-61159SB	25	38
Finish	Rose Gold	

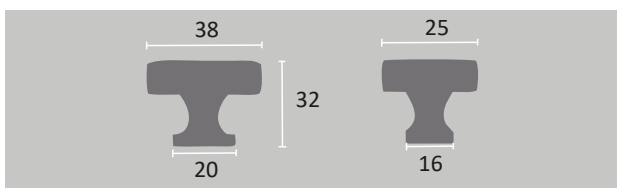

K-61159 Rectangle Knob - Whimsical

Material: Zn-Alloy

Item No.	W	Length
K-61159ORB	25	38

Finish	Image	Finish Name
		Oil Brush

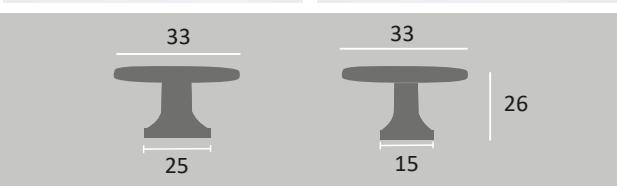

K-61368 Round Knob - Traditional

Material: Zn-Alloy

Item No.	H	Ø
K-61368MBC	26	33

Finish	Image	Finish Name
		Matte Black Chrome

handles & knobs

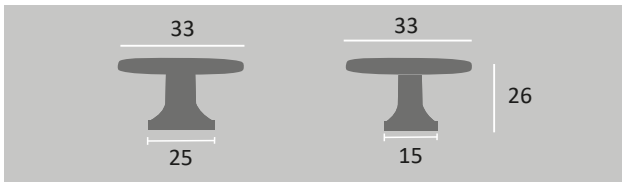

K-61368 Round Knob - Traditional

Material: Zn-Alloy

Item No.	H	Ø
K-61368BSS	26	33

Finish  Satin Nickel

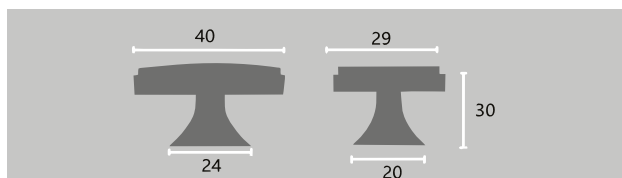

K-61703 Rectangle Knob - Transitional

Material: Zn-Alloy

Item No.	H	L
K-61703SB	30	60

Finish  Rose Gold

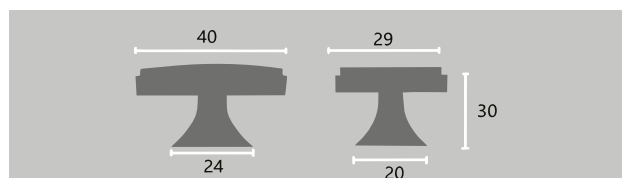

K-61703 Rectangle Knob - Transitional

Material: Zn-Alloy

Item No.	H	L
K-61703CP	30	60

Finish  Chrome

handles & knobs

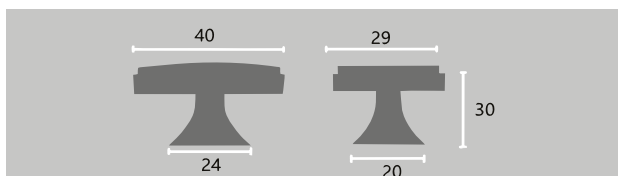

K-61703 Rectangle Knob - Transitional

Material: Zn-Alloy

Item No.	H	L
K-61703BK	30	60

Finish  Black

handles & knobs

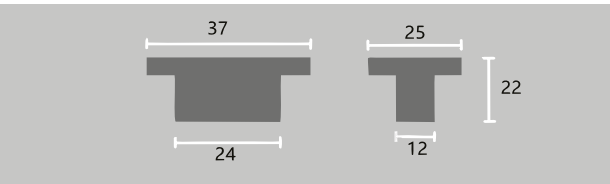

K-61705 Rectangle Knob - **Luxury**

Material: Zn-Alloy

Item No.	H	L
K-61705SB	22	37

Finish  Rose Gold

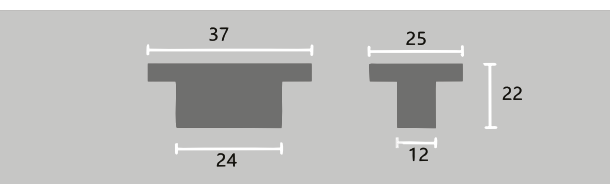

K-61705 Rectangle Knob - **Luxury**

Material: Zn-Alloy

Item No.	H	L
K-61705BSS	22	37

Finish  Satin Nickel



K-61707 Rectangle Knob - *Luxury*

Material: Zn-Alloy

Item No.	H	L
K-61707CP	21	38

Finish  Chrome

handles & knobs

handles & knobs

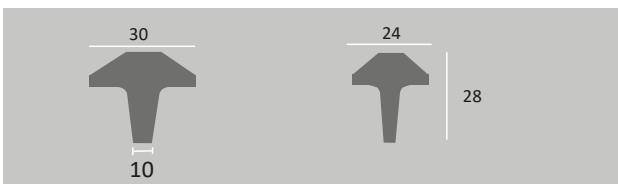

K- 61709 Rectangle Knob - Contemporary

Material: Zn-Alloy

Item No.	H	L
K-61709BSS	28	30

Finish



Satin Nickel



K-61709 Rectangle Knob - Contemporary

Material: Zn-Alloy

Item No.	H	L
K-61709SB	28	30

Finish



Rose Gold

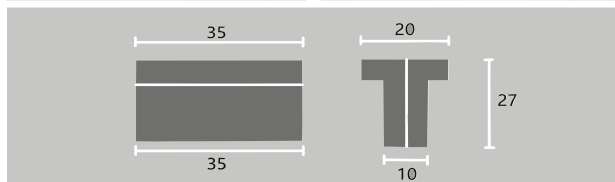

K-61711 Rectangle Knob - Contemporary

Material: Zn-Alloy

Item No.	H	L
K-61711BSS	27	35

Finish  Satin Nickel

handles & knobs

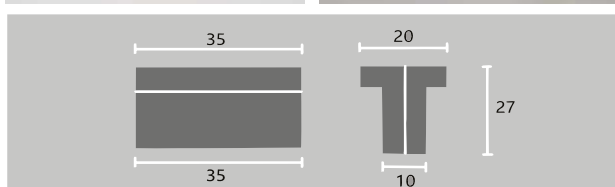

K-61711 Rectangle Knob - Contemporary

Material: Zn-Alloy

Item No.	H	L
K-61711SB	27	35

Finish  Rose Gold

handles & knobs

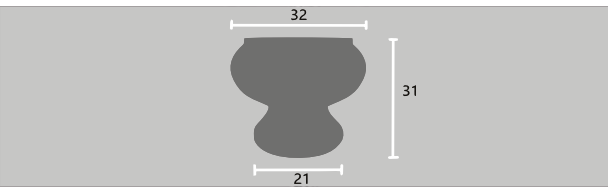

K-62123 Round Knob - Traditional

Material: Zn-Alloy

Item No.	H	Ø
K-62123BSS	27	35

Finish



Satin Nickel

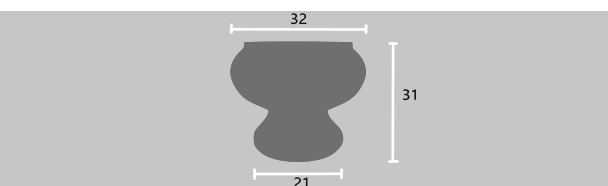

K-62123 Round Knob - Traditional

Material: Zn-Alloy

Item No.	H	Ø
K-62123ORB	27	35

Finish



Antique Oil Brushed

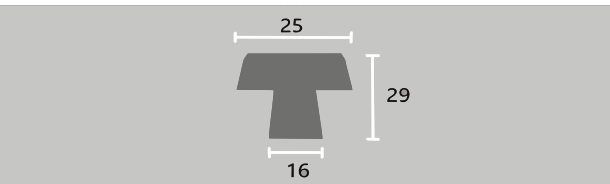

K-62217 Square Knob - Contemporary

Material: Zn-Alloy

Item No.	H	L
K-62217BSS	29	23

Finish



Satin Nickel

handles & knobs

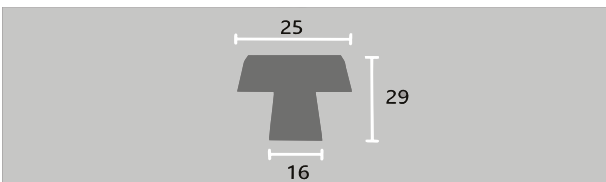
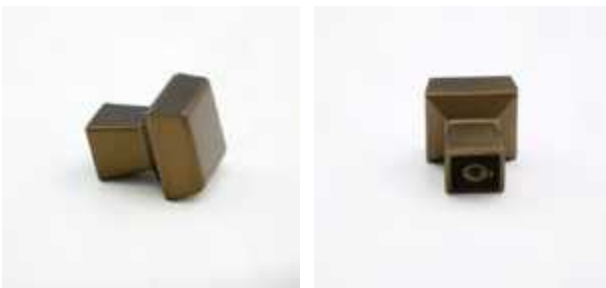

K-62217 Square Knob - Contemporary

Material: Zn-Alloy

Item No.	H	L
K-62217RG	29	23

Finish



Honey Brown

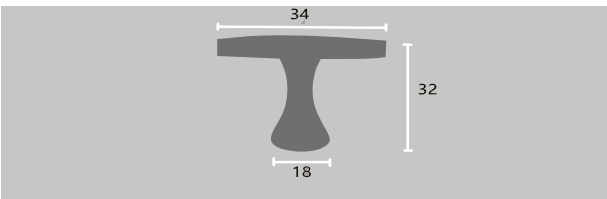

K-62231 Square Knob - Transitional

Material: Zn-Alloy

Item No.	H	L
K-62231BSS	32	34

Finish  Satin Nickel

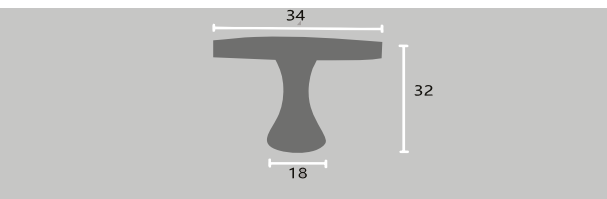

K-62231 Square Knob - Transitional

Material: Zn-Alloy

Item No.	H	L
K-62231RG	32	34

Finish  Honey Brown

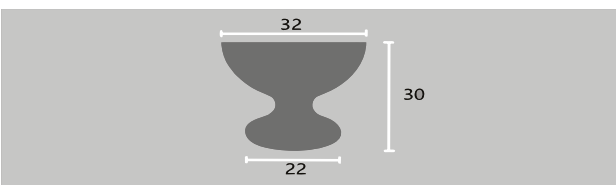

K-62301 Round Knob - Contemporary

Material: Zn-Alloy

Item No.	H	Ø
K-62301BORB	30	32

Finish  Antique Oil Brushed

handles & knobs

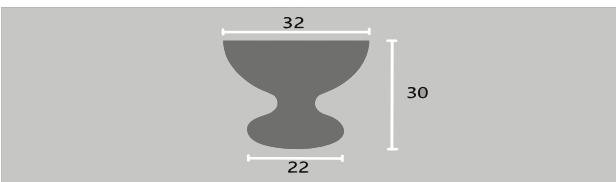

K-62301 Round Knob - Contemporary

Material: Zn-Alloy

Item No.	H	Ø
K-62301RG	30	32

Finish  Honey Brown

handles & knobs

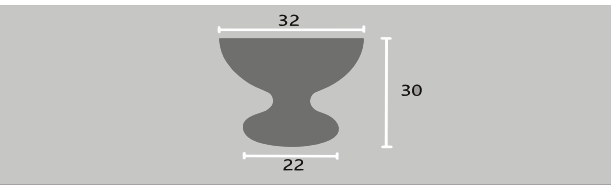

K-62301 Round Knob - Contemporary

Material: Zn-Alloy

Item No.	H	Ø
K-62301BSS	30	32

Finish  Satin Nickel

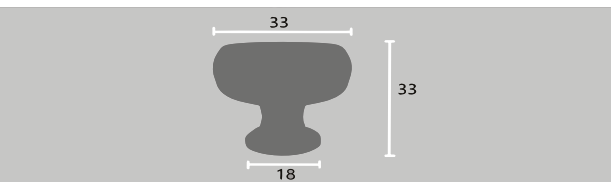

K-62343 Round Knob - Contemporary

Material: Zn-Alloy

Item No.	H	Ø
K-62343BSS	33	33

Finish  Satin Nickel

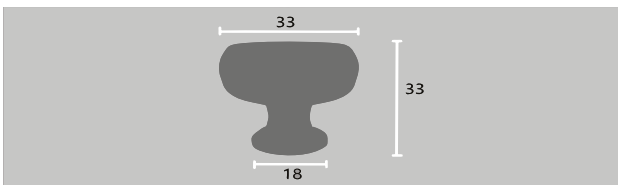

K-62343 Round Knob - Contemporary

Material: Zn-Alloy

Item No.	H	Ø
K-62343RG	33	33

Finish  Honey Brown

handles & knobs

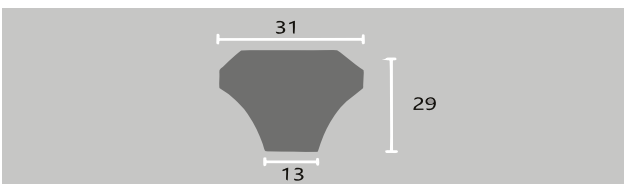

K-62861 Square Knob - Transitional

Material: Zn-Alloy

Item No.	H	L
K-62861BSS	29	31

Finish  Satin Nickel

handles & knobs

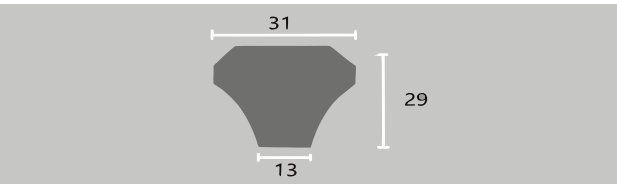

K-62861 Square Knob - **Transitional**

Material: Zn-Alloy

Item No.	H	L
K-62861RG	29	31

Finish  Honey Brown

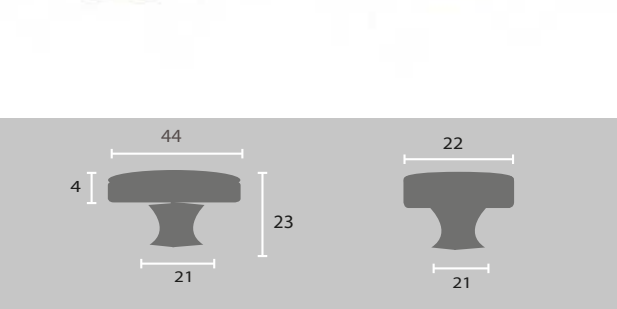

K-65804 Knob

Material: Zn-Alloy

Item No.	H	L
K-65804BK	23	44

Finish  Black



K-65804 Knob

Material: Zn-Alloy

Item No.	H	L
K-65804BSS	23	44

Finish  Brush Nickel

handles & knobs

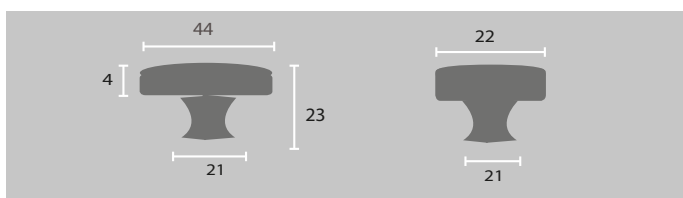

K-65804 Knob

Material: Zn-Alloy

Item No.	H	L
K-65804CP	23	44

Finish  Chrome

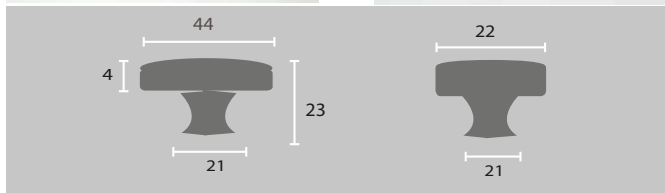

handles & knobs



K-65804 Round Knob

Material: Zn-Alloy

Item No.	H	L
K-65804GL	23	44

Finish  Gold

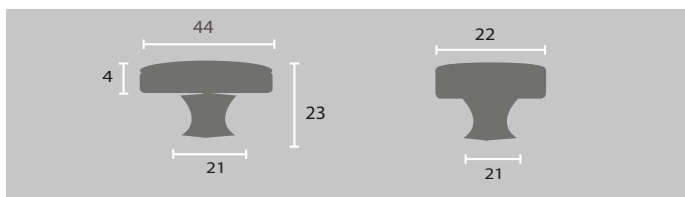

K-68135 Crystal Knob - The Shine in Your Eyes

Material: Zn-Alloy

Item No.	Height	Ø
K-68135	45	35

Finish  Chrome



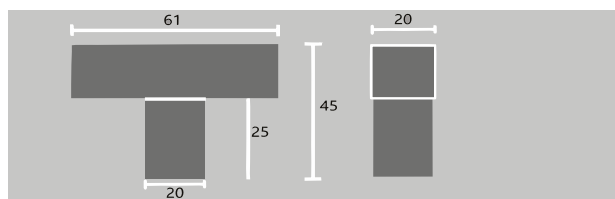

K-71725 T-Bar Knob - Contemporary

Material: Zn-Alloy

Item No.	H	L
K-71725BK	45	61

Finish  Matt Black

handles & knobs



K-71858 Crystal Knob - The Shine in Your Eyes

Material: Zn-Alloy

Item No.	Height	Ø
K-71858GL	42	30

Finish  Brushed Gold

K-71858 Crystal Knob - The Shine in Your Eyes

Material: Zn-Alloy

Item No.	Height	Ø
K-71858CP	42	30

Finish  Chrome

107° Hinges- Lift-off Soft Closing- Full Overlay (No Dowel)

With Cam Adjustment

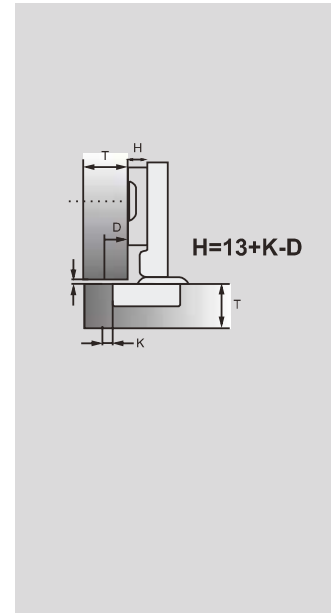

Item No.	Center (hole to hole)	Dowel (on cup)
HT-05AP	45	no Dowel

107° Hinges-Lift-off Soft Closing- Full Overlay (Dowel on cup)

With Cam Adjustment

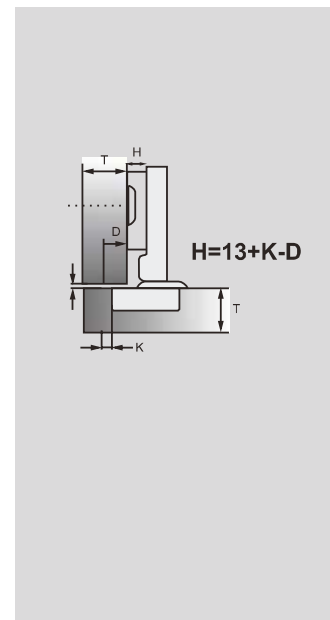

Item No.	Center (hole to hole)	Dowel (on cup)
HT-05AP(D)	45	Ø 8×12

107° Hinges- Lift-off Soft Closing- Full Overlay (Dowel on cup & plate)

With Cam Adjustment



Item No.	Center (hole to hole)	Dowel (on cup)	Dowel (on plate)
HT-05AP(DD)	45	Ø 8×12	Ø 5×11

hinges

107 ° Hinges - Soft Closing - Full Overlay

With Cam Adjustment

Dowels on Hinge & Euro Screw on Plate

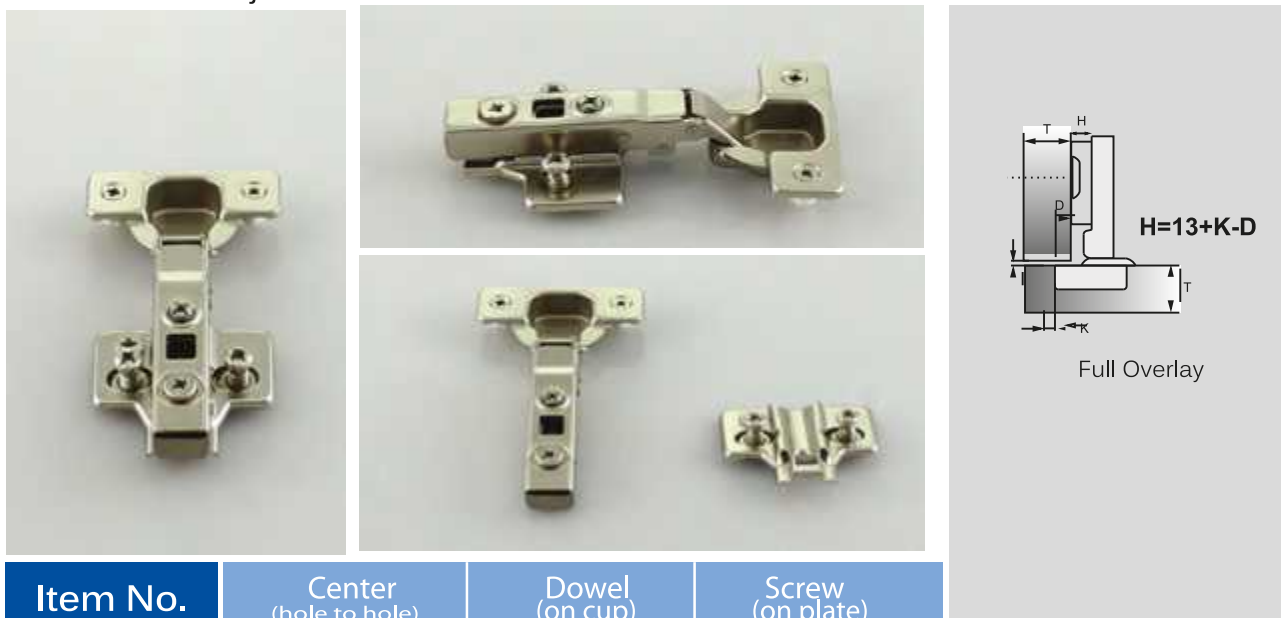

Item No.	Center (hole to hole)	Dowel (on cup)	Screw (on plate)
HT -05AP(DE)	45	Ø 8 x 12	Ø 6.3 x 14

107 ° Hinges - Soft Closing - Half Overlay (No Dowel)

With Cam Adjustment

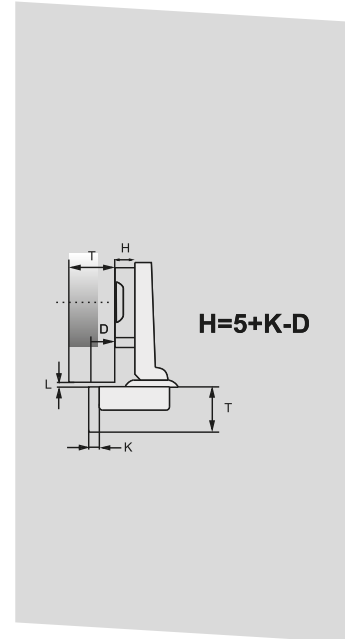

Item No.	Center (hole to hole)	Dowel (on cup)
HT-05BP	45	no Dowel

107 ° Hinges - Soft Closing - Inset (No Dowel)

With Cam Adjustment

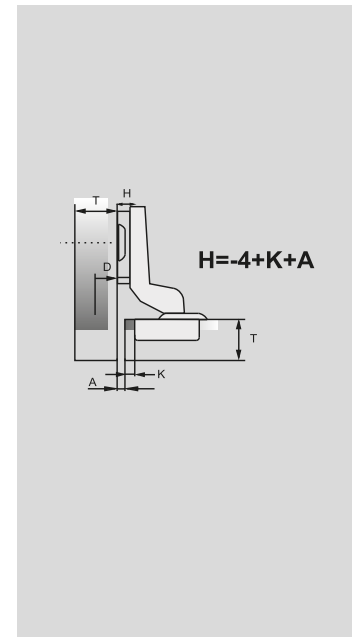

Item No.	Center (hole to hole)	Dowel (on cup)
HT-05CP	45	no Dowel

hinges

45 ° Hinges - Soft Closing (No Dowel)



Item No.	Centre (hole to hole)	Dowel (on cup)
HT-45AP	45	No Dowel

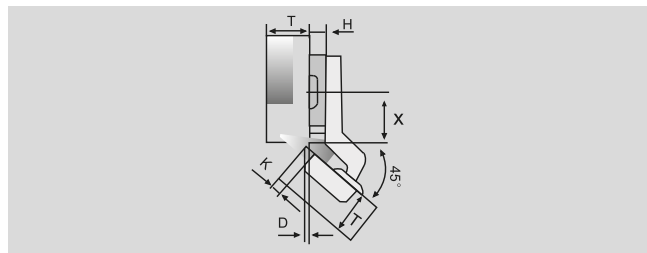

hinges

45 ° Hinges - Soft Closing (Dowel on Cup)



Item No.	Centre (hole to hole)	Dowel (on cup)
HT-45AP(D)	45	Ø 8x12

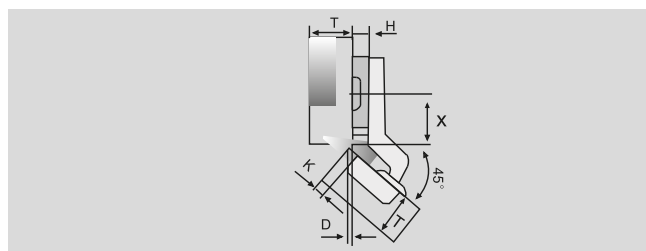

90° Blind Panel Hinges - Soft Closing (No Dowel)



Item No.	Centre (hole to hole)	Dowel (on cup)
HT-90(AP)	45	No Dowel

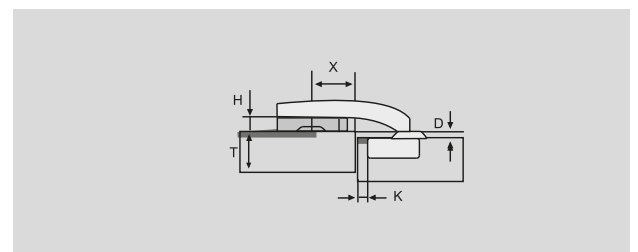

90° Blind Panel Hinges - Soft Closing (Dowel on cup)



Item No.	Centre (hole to hole)	Dowel (on cup)
HT-90AP(D)	45	Ø 8x12

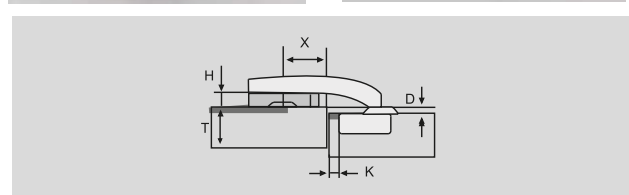

hinges

170 ° Hinge - Soft Closing (No Dowel)



Item No.	Centre (hole to hole)	Dowel (on cup)
----------	--------------------------	-------------------

HT-170(AP)	45	No Dowel
------------	----	----------

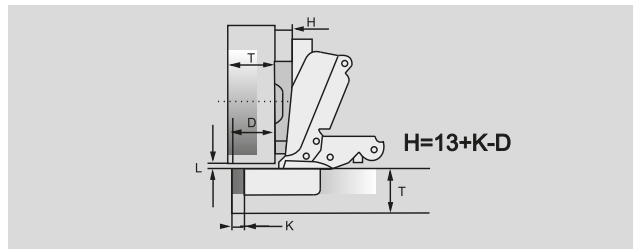

hinges

170 ° Hinge - Soft Closing (Dowel on cup)

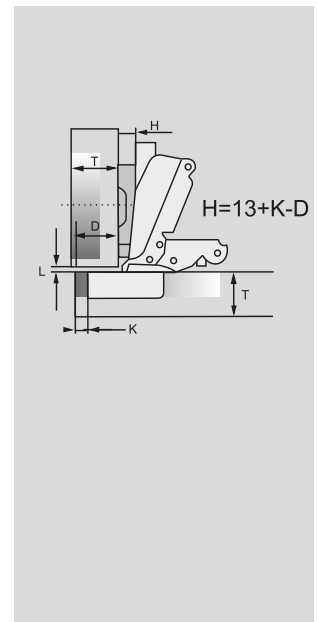

Item No.	Centre (hole to hole)	Dowel (on cup)
----------	--------------------------	-------------------

HT-170AP(D)	45	Ø 8 x 12
-------------	----	----------

107° Hinges- Fast-Fit Lift-off Soft Closing- Full Overlay (Dowel on cup) With Cam Adjustment

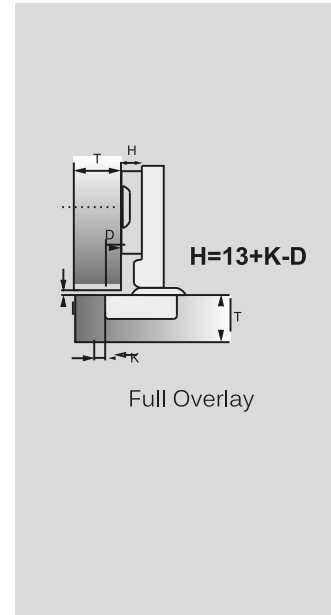

Item No.	Center (hole to hole)	Dowel (on cup)
HT-03AP(X)	45	Ø 8×12

107° Hinges- Fast-Fit Lift-off Soft Closing- Full Overlay (Dowel on plate) With Cam Adjustment

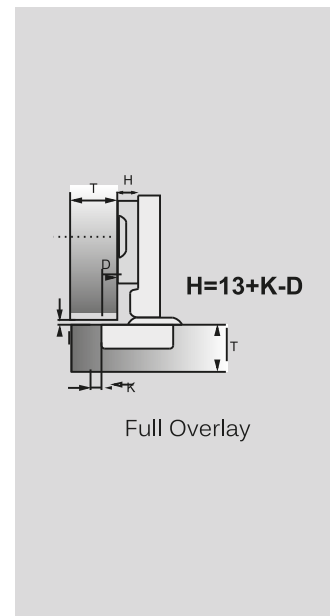

Item No.	Center (hole to hole)	Dowel (on cup)	Dowel (on plate)
HT-03AP(XD)	45	Ø 8×12	Ø 5×11

hinges

107 ° Hinges - Regular - Full Overlay (No Dowel)

With Cam Adjustment

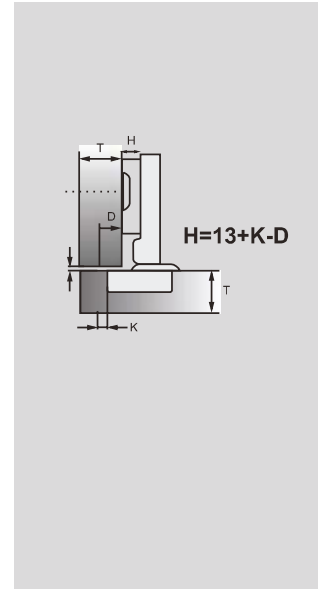

Item No.	Center (hole to hole)	Dowel (on cup)
ET-01AP	45	no Dowel

107 ° Hinges - Regular - Full Overlay (Dowel on Cup)

With Cam Adjustment

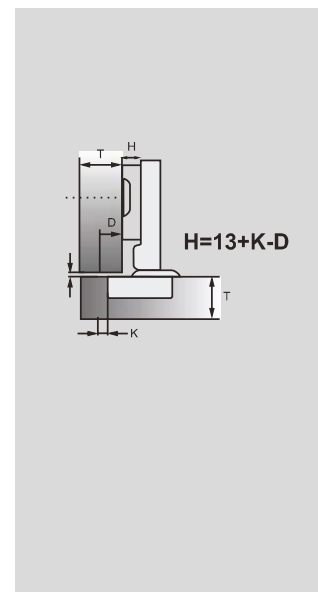

Item No.	Center (hole to hole)	Dowel (on cup)
ET-01AP(D)	45	Dowel on Cup

hinges

107 ° Hinges - Regular - Full Overlay (Dowel on Cup & Plate) With Cam Adjustment

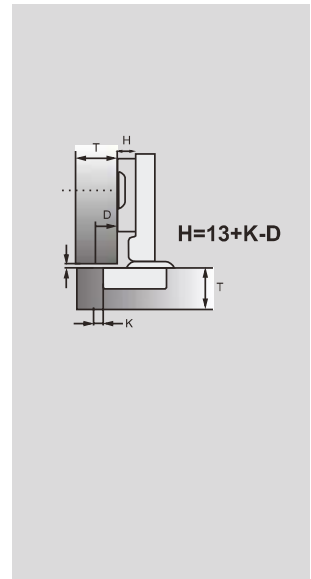

Item No.	Center (hole to hole)	Dowel (on cup)	Dowel (on plate)
ET-01AP(DD)	45	Ø 8×12	Ø 5×11

107 ° Hinges - Regular - Full Overlay (Dowel & Euro Screw) With Cam Adjustment

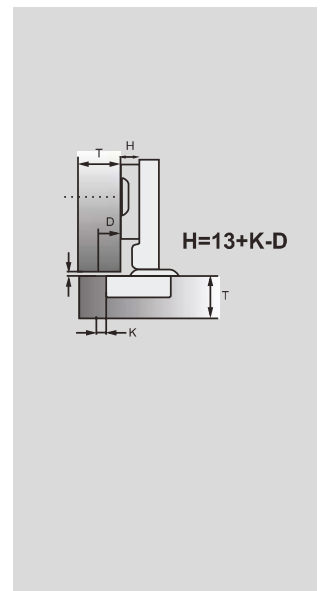

Item No.	Center (hole to hole)	Dowel (on cup)	Screw (on plate)
ET-01AP(DE)	45	Ø 8×12	Ø 6.3 x 14

hinges

107 ° Hinges - Regular - Half Overlay (No Dowel)

With Cam Adjustment

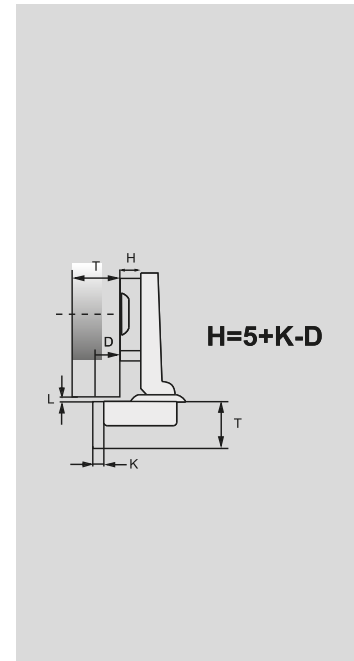

Item No.	Center (hole to hole)	Dowel (on cup)
ET-01BP	45	no Dowel

107 ° Hinges - Regular- Inset (No Dowel)

With Cam Adjustment

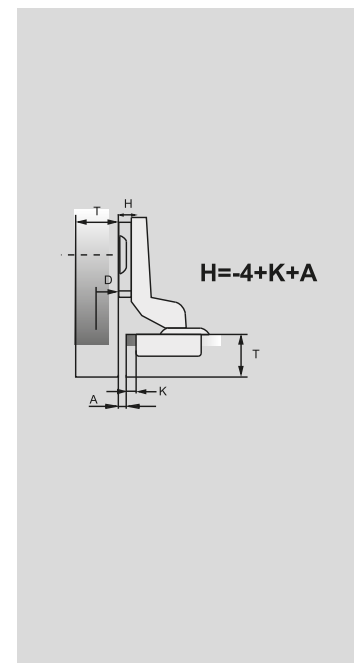

Item No.	Center (hole to hole)	Dowel (on cup)
ET-01CP	45	no Dowel

hinges

45° Hinges - Tilt-off Regular (No Dowel) With Cam Adjustment

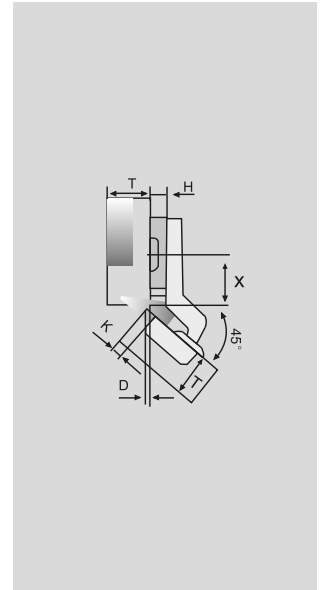

Item No.	Center (hole to hole)	Dowel (on cup)
ET-45AP	45	No Dowel

45° Hinges - Tilt-off Regular (Dowel on Cup) With Cam Adjustment

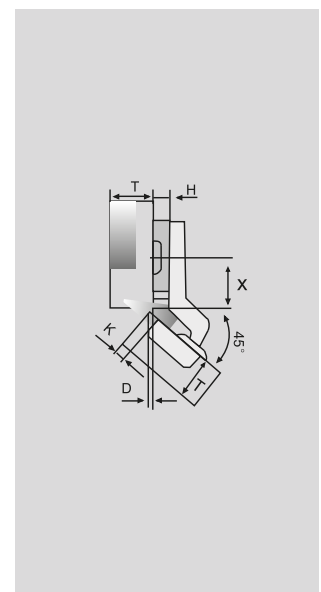

Item No.	Center (hole to hole)	Dowel (on cup)
ET-45AP(D)	45	Ø 8×12

90° Hinges - Tilt-off Regular (No Dowel) With Cam Adjustment

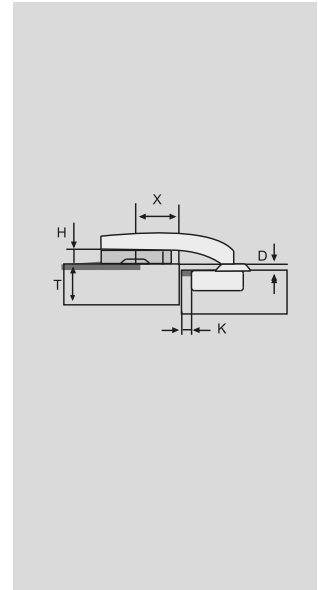

Item No.	Center (hole to hole)	Dowel (on cup)
ET-90AP	45	No Dowel

hinges

90° Hinges - Tilt-off Regular (Dowel on Cup) With Cam Adjustment

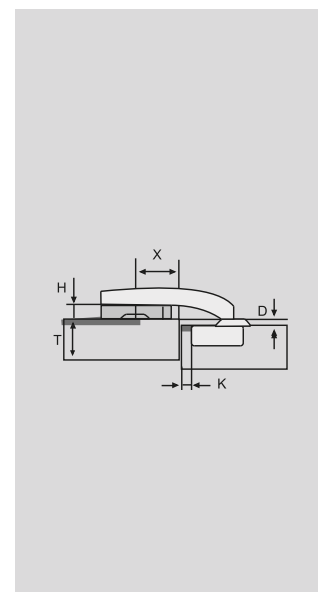

Item No.	Center (hole to hole)	Dowel (on cup)
ET-90AP(D)	45	∅ 8×12

135° Hinges - Regular (No Dowel) With Cam Adjustment

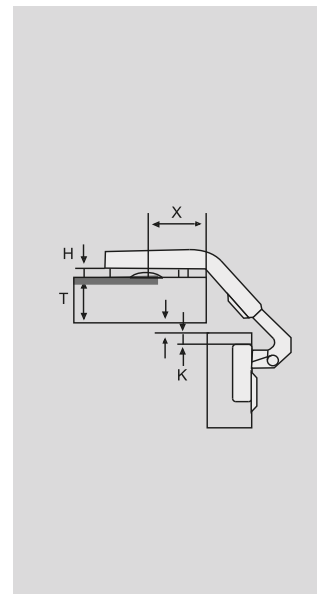

Item No.	Center (hole to hole)	Dowel (on cup)
ET-135AP	45	No Dowel

135° Hinges - Regular (Dowel on Cup) With Cam Adjustment

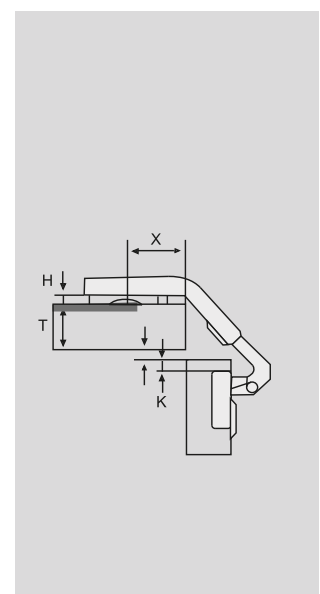

Item No.	Center (hole to hole)	Dowel (on cup)
ET-135AP(D)	45	Ø 8×12

170° Hinges - Tilt-off Regular (No Dowel) With Cam Adjustment

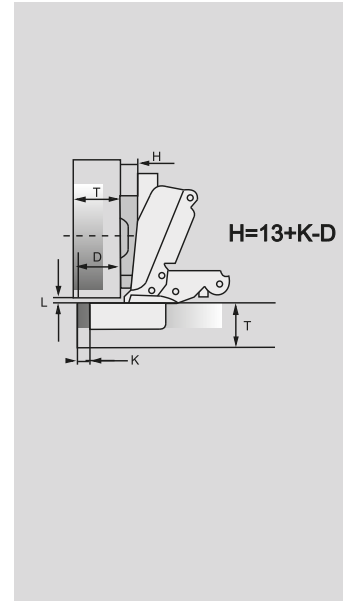

Item No.	Center (hole to hole)	Dowel (on cup)
ET-170AP	45	No Dowel

hinges

107° Hinges - Tilt-off Regular (Dowel on Cup) With Cam Adjustment

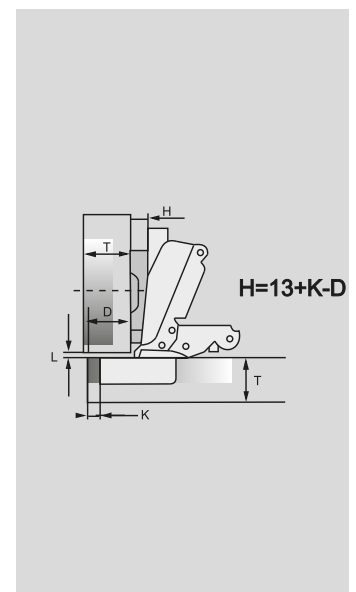

Item No.	Center (hole to hole)	Dowel (on cup)
ET-170AP(D)	45	∅ 8×12

Soft Closing Ball Bearing Full Extension Slides (Side Mounted)

Load Capacity: 40kg

Colour: Zinc

Item No.	Size
SW-08-300	12"
SW-08-350	14"
SW-08-400	16"
SW-08-450	18"
SW-08-500	20"
SW-08-550	22"
SW-08-600	24"

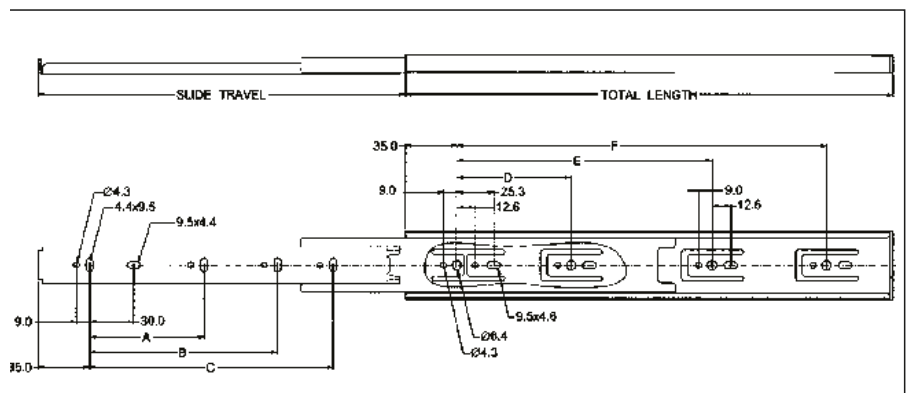
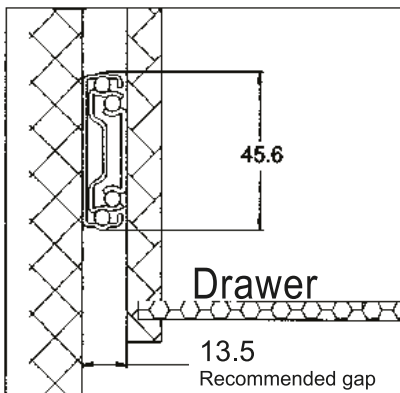

Size	Slide travel	A	B	C	D	E	F
300	285	96	-	-	96	-	-
350	345	128	224	-	128	-	-
400	400	128	256	-	128	192	-
450	450	128	320	-	128	256	-
500	500	128	224	352	128	256	-
550	550	128	256	384	128	224	320
600	600	128	288	416	128	224	352

slides

Soft Closing Ball Bearing Full Extension Slides (Side Mounted)

Load Capacity: 35kg

Colour: Zinc

Item No.	Size
SW-46-300	12"
SW-46-355	14"
SW-46-405	16"
SW-46-450	18"
SW-46-500	20"
SW-46-550	22"
SW-46-600	24"

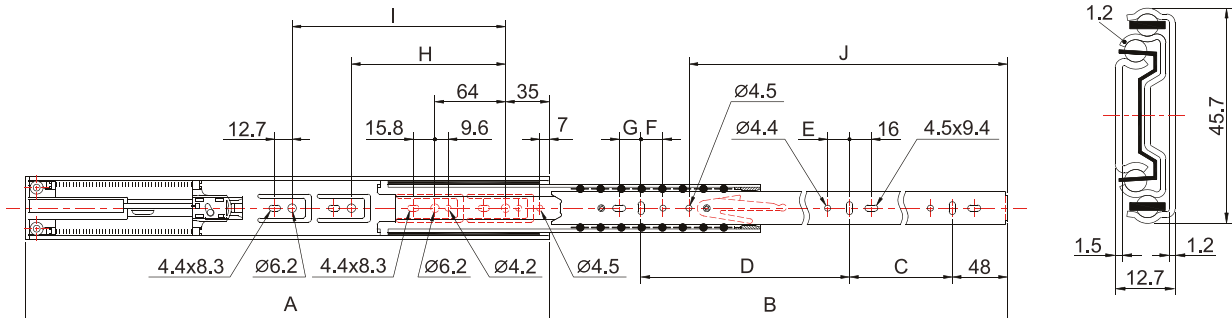
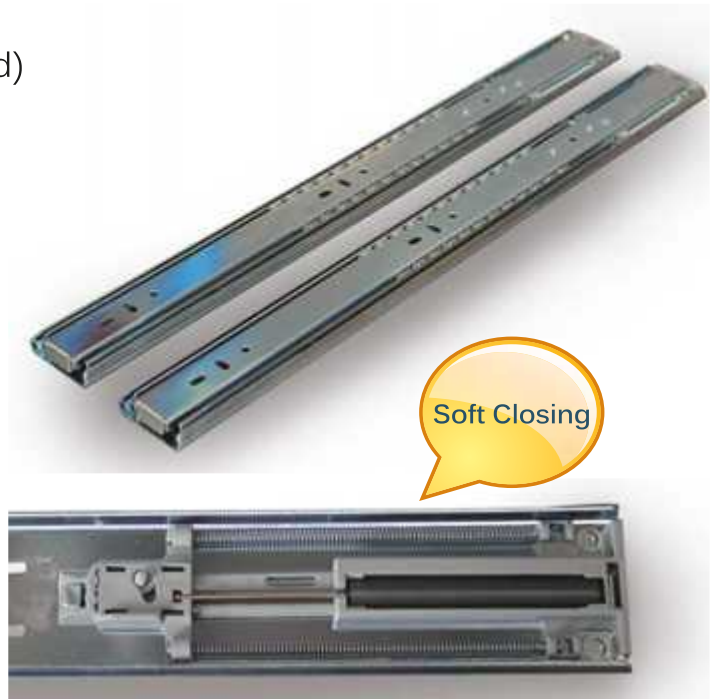

Length A(mm)	Travel B(mm)	C(mm)	D(mm)	E(mm)	F(mm)	G(mm)	H(mm)	I(mm)	J(mm)
355	350	128	-	-	-	-	128	-	-
405	400	160	-	16	-	-	160	-	-
450	450	160	-	16	-	-	224	-	336
500	500	192	128	16	16	16	256	-	-
550	550	224	160	16	16	-	224	320	-
600	600	256	192	16	16	16	320	-	-

slides



Soft Closing Ball Bearing Full Extension Slides (Side Mounted)

Load Capacity: 40kg

Colour: Zinc

Item No	Size
SW-59-300	12"
SW-59-350	14"
SW-59-400	16"
SW-59-450	18"
SW-59-500	20"
SW-59-550	22"



Standard Ball Bearing Full Extension Slides (Side Mounted)

Load Capacity: 45kg

Colour: Zinc

Item No.	Size
RB-01-250	10"
RB-01-300	12"
RB-01-350	14"
RB-01-400	16"
RB-01-450	18"
RB-01-500	20"
RB-01-550	22"
RB-01-600	24"





Soft Closing Concealed Full Extension Slides (Under Mounted) With 3D adjustment brackets

Load Capacity: 25kg

Colour: Zinc

Item No	Size	
SC-49-300	12"	
SC-49-350	14"	
SC-49-400	16"	
SC-49-450	18"	
SC-49-500	20"	
SC-49-550	22"	



Soft Closing

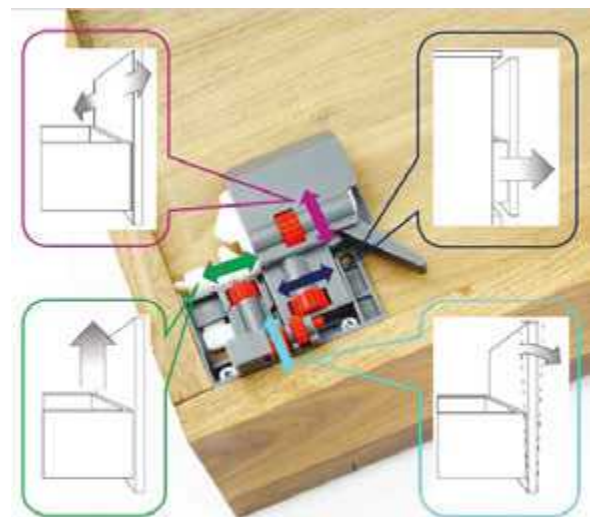

FIT BOX Slim Wall Soft Closing Drawer (Dark Grey)



Item No.	Drawer Length	Height
SL-86-270N	270mm (10 ⁵ / ₈ "	86mm (3 ³ / ₈ "
SL-86-350N	350mm (14")	86mm (3 ³ / ₈ "
SL-86-400N	400mm (16")	86mm (3 ³ / ₈ "
SL-86-450N	450mm (18")	86mm (3 ³ / ₈ "
SL-86-500N	500mm (20")	86mm (3 ³ / ₈ "
SL-86-550N	550mm (22")	86mm (3 ³ / ₈ "

Item No.	Drawer Length	Height
SL-167-350N	350mm (14")	167mm (6 ¹ / ₂ "
SL-167-400N	400mm (16")	167mm (6 ¹ / ₂ "
SL-167-450N	450mm (18")	167mm (6 ¹ / ₂ "
SL-167-500N	500mm (20")	167mm (6 ¹ / ₂ "
SL-167-550N	550mm (22")	167mm (6 ¹ / ₂ "

Item No.	Drawer Length	Height
SL-118-270N	270mm (10 ⁵ / ₈ "	118mm (4 ⁵ / ₈ "
SL-118-350N	350mm (14")	118mm (4 ⁵ / ₈ "
SL-118-400N	400mm (16")	118mm (4 ⁵ / ₈ "
SL-118-450N	450mm (18")	118mm (4 ⁵ / ₈ "
SL-118-500N	500mm (20")	118mm (4 ⁵ / ₈ "
SL-118-550N	550mm (22")	118mm (4 ⁵ / ₈ "

Item No.	Drawer Length	Height
SL-199-450N	450mm (18")	199mm (7 ⁷ / ₈ "
SL-199-500N	500mm (20")	199mm (7 ⁷ / ₈ "
SL-199-550N	550mm (22")	199mm (7 ⁷ / ₈ "



Load capacity 40kg

FIT BOX Slim Wall Soft Closing Drawer (White)



Item No.	Drawer Length	Height
SL-86-270W	270mm (10 ⁵ / ₈ "	86mm (3 ³ / ₈ "
SL-86-350W	350mm (14")	86mm (3 ³ / ₈ "
SL-86-400W	400mm (16")	86mm (3 ³ / ₈ "
SL-86-450W	450mm (18")	86mm (3 ³ / ₈ "
SL-86-500W	500mm (20")	86mm (3 ³ / ₈ "
SL-86-550W	550mm (22")	86mm (3 ³ / ₈ "

Item No.	Drawer Length	Height
SL-167-350W	350mm (14")	167mm (6 ¹ / ₂ "
SL-167-400W	400mm (16")	167mm (6 ¹ / ₂ "
SL-167-450W	450mm (18")	167mm (6 ¹ / ₂ "
SL-167-500W	500mm (20")	167mm (6 ¹ / ₂ "
SL-167-550W	550mm (22")	167mm (6 ¹ / ₂ "

Item No.	Drawer Length	Height
SL-118-270W	270mm (10 ⁵ / ₈ "	118mm (4 ⁵ / ₈ "
SL-118-350W	350mm (14")	118mm (4 ⁵ / ₈ "
SL-118-400W	400mm (16")	118mm (4 ⁵ / ₈ "
SL-118-450W	450mm (18")	118mm (4 ⁵ / ₈ "
SL-118-500W	500mm (20")	118mm (4 ⁵ / ₈ "
SL-118-550W	550mm (22")	118mm (4 ⁵ / ₈ "

Item No.	Drawer Length	Height
SL-199-350W	350mm (14")	199mm (7 ⁷ / ₈ "
SL-199-400W	400mm (16")	199mm (7 ⁷ / ₈ "
SL-199-450W	450mm (18")	199mm (7 ⁷ / ₈ "
SL-199-500W	500mm (20")	199mm (7 ⁷ / ₈ "
SL-199-550W	550mm (22")	199mm (7 ⁷ / ₈ "

FIT BOX Slim Wall Soft Closing Drawer (Silver Grey)



Item No.	Drawer Length	Height
SL-86-270G	270mm (10 ⁵ / ₈ "	86mm (3 ³ / ₈ "
SL-86-350G	350mm (14"	86mm (3 ³ / ₈ "
SL-86-400G	400mm (16"	86mm (3 ³ / ₈ "
SL-86-450G	450mm (18"	86mm (3 ³ / ₈ "
SL-86-500G	500mm (20"	86mm (3 ³ / ₈ "
SL-86-550G	550mm (22"	86mm (3 ³ / ₈ "

Item No.	Drawer Length	Height
SL-167-450G	450mm (18"	167mm (6 ¹ / ₂ "
SL-167-500G	500mm (20"	167mm (6 ¹ / ₂ "
SL-167-550G	550mm (22"	167mm (6 ¹ / ₂ "

Item No.	Drawer Length	Height
SL-118-270G	270mm (10 ⁵ / ₈ "	118mm (4 ⁵ / ₈ "
SL-118-350G	350mm (14"	118mm (4 ⁵ / ₈ "
SL-118-400G	400mm (16"	118mm (4 ⁵ / ₈ "
SL-118-450G	450mm (18"	118mm (4 ⁵ / ₈ "
SL-118-500G	500mm (20"	118mm (4 ⁵ / ₈ "
SL-118-550G	550mm (22"	118mm (4 ⁵ / ₈ "

Item No.	Drawer Length	Height
SL-199-450G	450mm (18"	199mm (7 ⁷ / ₈ "
SL-199-500G	500mm (20"	199mm (7 ⁷ / ₈ "
SL-199-550G	550mm (22"	199mm (7 ⁷ / ₈ "



Item No.	Description	Size [height]	Color
CL-T2A100	Cabinet Leg	3¾" - 5¼"	Black



Item No.	Description	Size [height]	Color
CL-T2A120	Cabinet Leg	4½" - 5½"	Black



Item No.	Description	Size [height]	Color
CL-T2A150	Cabinet Leg	5¾" - 7"	Black



Item No.	Description	Size [height]	Color
CL-TD150	Square Top Leg	4-1/8" - 6"	Black



Item No.	Description	Size [height]	Color
CL-TC160	Cabinet Leg	3¾" - 6¼"	Black



Item No.	Description	Size [height]	Color
CL-A183BSS	Cabinet Leg, angle	H 4¾"	Steel



Item No.	Description	Size [height]	Color
CL-A183CP	Cabinet Leg, angle	H 4¾"	Chrome

#6 Flat Head

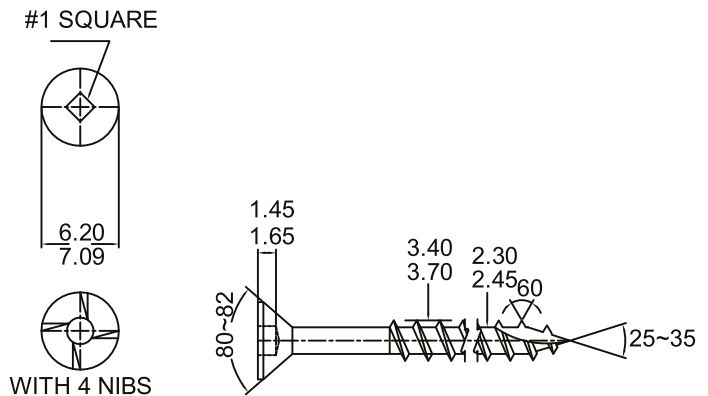

Item #	Size	Description	Finish
06058FH	#6×5/8"	Flat head, # 1 Square, Type 17,With 4 Nibs	Zinc
06058FH2	#6×5/8"	Flat head, # 2 Square, Type 17,With 4 Nibs	Zinc
06034FH2	#6X3/4"	Flat head, #2 Square, Type 17, With 4 Nibs	Zinc
060134FH2	#6×1-3/4"	Flat head, #2 Square, Type 17,With 4 Nibs	Zinc

#8 Flat Head

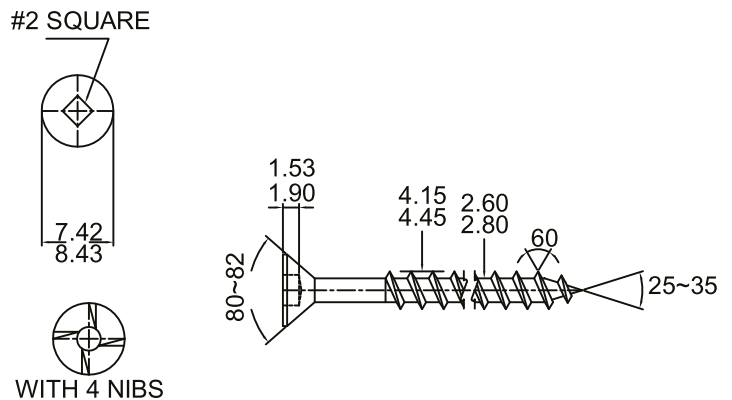
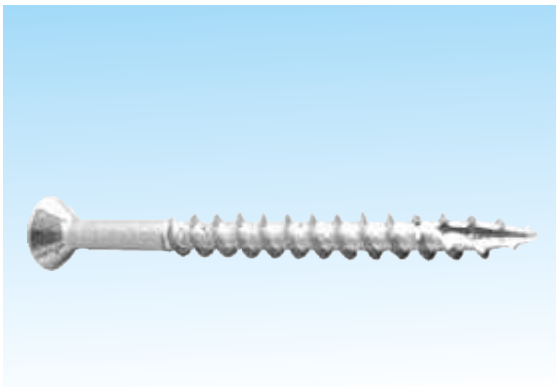

Item #	Size	Description	Finish
0801FH	#8×1"	Flat head, # 2 Square, Type 17,With 4 Nibs	Zinc
080118FH	#8×1-1/8"	Flat head, # 2 Square, Type 17,With 4 Nibs	Zinc
080114FH	#8×1-1/4"	Flat head, # 2 Square, Type 17,With 4 Nibs	Zinc
080112FH	#8×1-1/2"	Flat head, # 2 Square, Type 17,With 4 Nibs	Zinc
080134FH	#8×1-3/4"	Flat head, # 2 Square, Type 17,With 4 Nibs	Zinc
0802FH	#8×2"	Flat head, # 2 Square, Type 17,With 4 Nibs	Zinc
080212FH	#8×2-1/2"	Flat head, # 2 Square, Type 17,With 4 Nibs	Zinc
0803FH	#8×3"	Flat head, # 2 Square, Type 17,With 4 Nibs	Zinc

#8 Pan Head

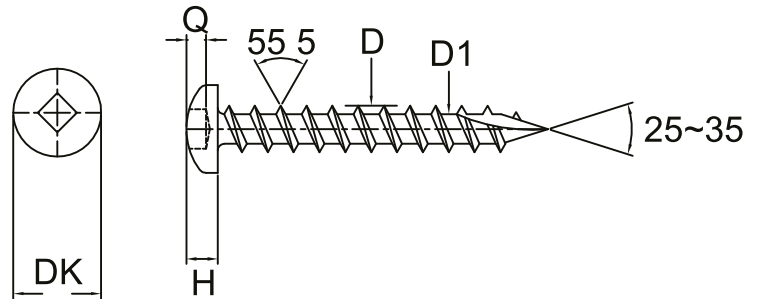
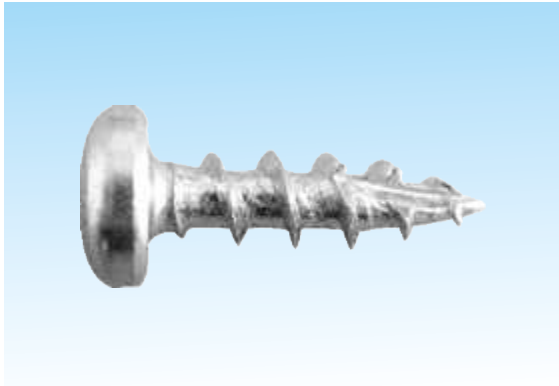

Item #	Size	Description	Finish
08058PH	#8×5/8"	Pan head, # 2 Square, Type 17	Zinc

#8 Round Washer Head

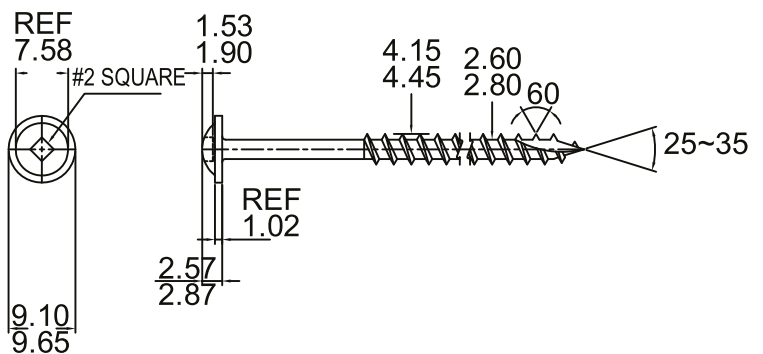
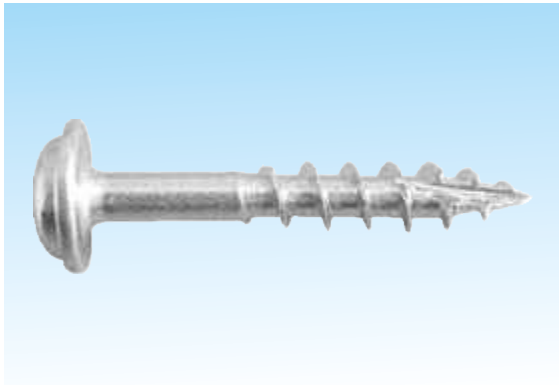

Item #	Size	Description	Finish
080118RWH	#8×1-1/8"	Washer head, # 2 Square, Type 17	Zinc
080114RWH	#8×1-1/4"	Washer head, # 2 Square, Type 17	Zinc
080212RWH	#8×2-1/2"	Washer head, # 2 Square, Type 17	Zinc

#8 Break-off Handle Screw

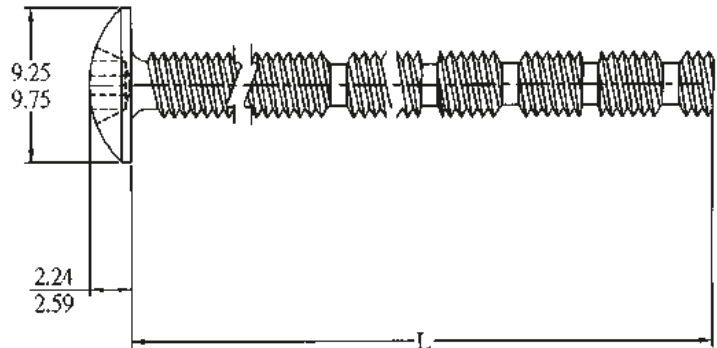

Item #	Size	Description	Finish
32MS030BF	#8-32 × 1~3/4"	Pan head, # 2 Square, Handle screw	Zinc

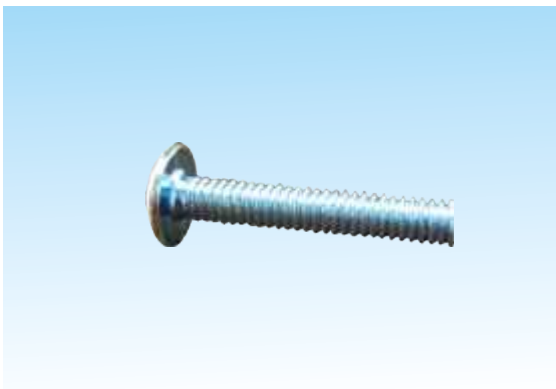

Item #	Size	Description	Finish
#8/32*1~1/8"	1~1/8"	Handle screw, philips	Zinc
#8/32*1~1/2"	1~1/2"	Handle screw, philips	Zinc
#8/32*1~3/8"	1~3/8"	Handle screw, philips	Zinc
#8/32*1~5/8"	1~5/8"	Handle screw, philips	Zinc
#8/32*1~3/4"	1~3/4"	Handle screw, philips	Zinc
#8/32*1~1/4"	1~1/4"	Handle screw, philips	Zinc

Euro Screw

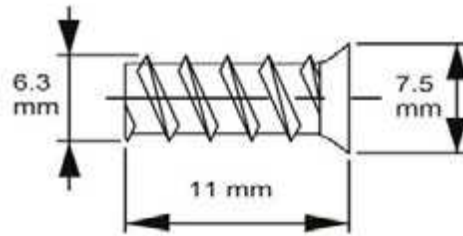

Item #	Size	Description	Finish
086311FH	M6.3 x 11mm	Flat Head, #2 Square	Zinc

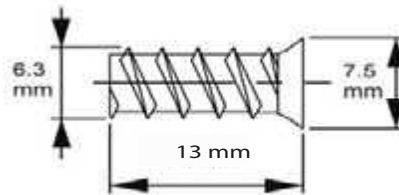

Item #	Size	Description	Finish
086313FH	M6.3 x 13mm	Flat Head, #2 Square	Zinc

Bit square



Item #	Size	Description	Finish
11R0251	R1x25mm	2 in 1 square Bit	Green
11R0252	R2x25mm	2 in 1 square Bit	Red
11R0501	R1x50mm	2 in 1 square Bit	Green
11R0502	R2x50mm	2 in 1 square Bit	Red
11R1501	R1x150mm	2 in 1 square Bit	Green
11R1502	R2x150mm	2 in 1 square Bit	Red

Quick release holder

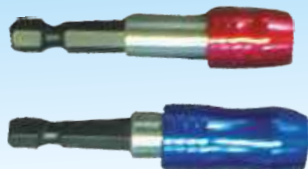

Item #	Size	Description	Finish
12HD060	60mm	Double Magnetic Bit Holder	Blue
12HL060	60mm	Quick Release Bit Holder	Blue
12HL075	75mm	Quick Release Bit Holder	Blue
12HS060	60mm	Quick Release Bit Holder	Red
12HS075	75mm	Quick Release Bit Holder	Red

Adjustable holder

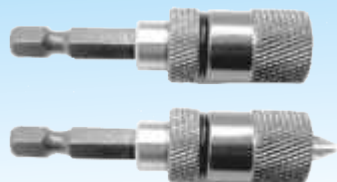

Item #	Size	Description	Finish
12HA060	60mm	Adjustable Locator	Sliver
12HA075	75mm	Adjustable Locator	Sliver

Nail

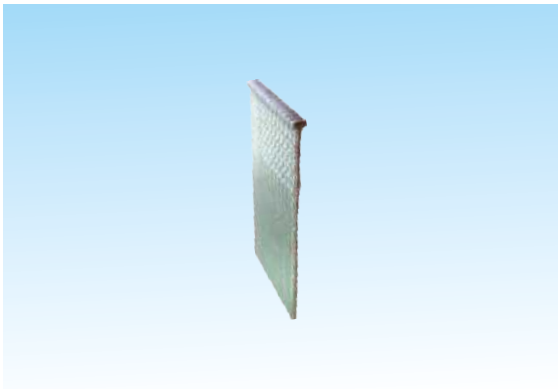

Item #	Size	Description	Finish
16G*2"N	16G X 2"N	Nail	Zinc
18G*2"N	18G x 2"N	Nail	Zinc
18G*1"N	18G X 1"N	Nail	Zinc
18G*1-1/4"N	18G X 1 ~ 1/4"N	Nail	Zinc
18G*1-3/4"N	18G X 1 ~ 3/4"N	Nail	Zinc

Staple

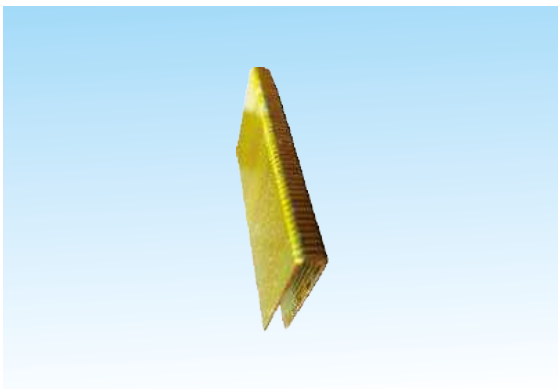

Item #	Size	Description	Finish
18G*1"S	18G X 1"S	Staple	Zinc
18G*1-1/8"S	18G X 1 ~ 1/8"S	Staple	Zinc
18G*1-1/4"S	18G X 1 ~ 1/4"S	Staple	Zinc
18G*1-1/2"S	18G X 1 ~ 1/2"S	Staple	Zinc

Laundry basket



closet & storage

Item No.	Colour	Product Size	Basket Volumn
ZLD-018	White	W16~1/8" -16~3/8" x D21" x H25"	53L

Hydraulic Wall Lift



closet & storage

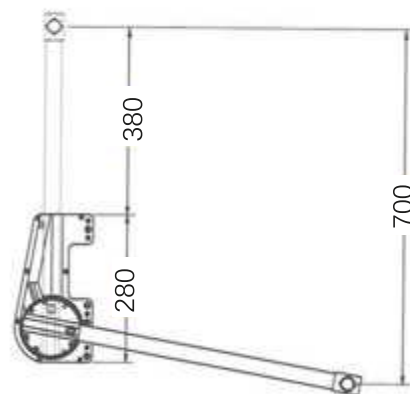
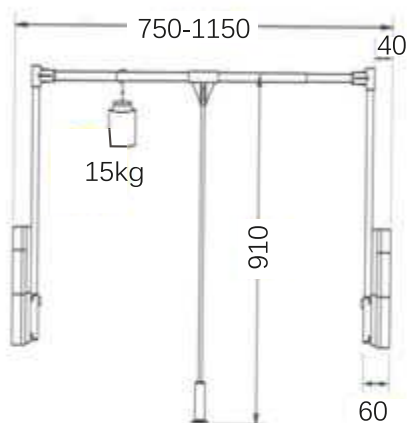

Item No.	Colour	Product Size	Max Load Capacity
ZLF-700	Grey	W31 - 48" x H36"	15kg
ZLF-700BK	Black	W31 - 48" x H36"	15kg

Hook for clothes



Item No.	Size	Colour
ZHK-692BK	H3"	Black
ZHK-692BSS	H3"	Brushed Nickel
ZHK-692GL	H3"	Gold
ZHK-692WT	H3"	White



Item No.	Size	Colour
ZHK-701BK	H5"	Black
ZHK-701BSS	H5"	Brushed Nickel
ZHK-701GL	H5"	Gold
ZHK-701WT	H5"	White

Oval Hanging Rail

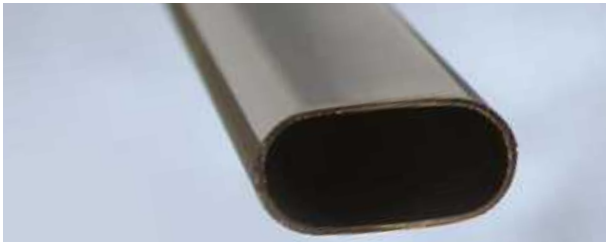

Material: Steel Finish: Chrome

Item No.	Size	Length
TH-006	15x30mm	304.8 cm

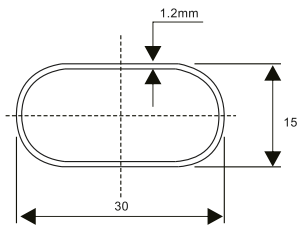

End Support



Finish: Zinc

Item No.	Size
FHA-01	15x30mm

End Support (With Pins)



Finish: Zinc

Item No.	Size
FHA-02	15x30mm

Concealed End Support



Finish: Chrome

Item No.	Size
FHU-01PC	15x30mm

End Support (Top Fix)



Finish: Chrome

Item No.	Height
FAE-09V	85~120 mm

Middle Support (Top Fix)



Finish: Chrome

Item No.	Height
FAM-05V	85~120 mm

Middle Support - Non-Adjustable



Finish: Chrome

Item No.	Height
FHM-05	70 mm

Round Hanging Rail

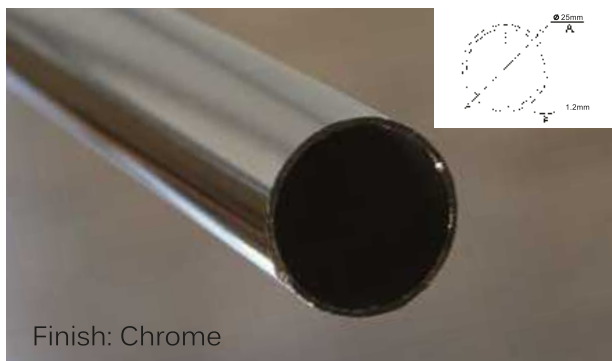

Finish: Chrome

Item No.	Ø	Length
TH-005	25mm	304.8 cm

Concealed End Support



Item No.	Ø
FHR-88	25mm

closet & storage

Middle Support (Top Fix)



Finish: Chrome

Item No.	Height
FAM-05R	80~115 mm

End Support

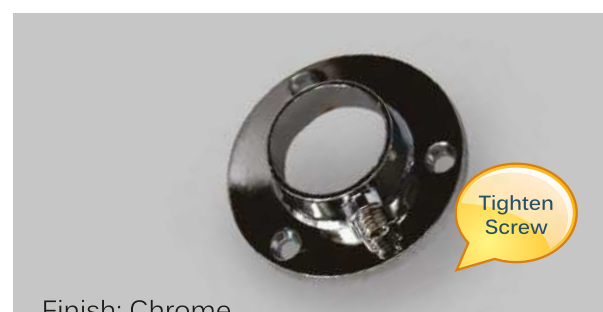

Finish: Chrome

Item No.	Ø
FHR-05	25mm

Pull Out Iron Board



Extra Cover Available

Item No.	Size	Colour	Load Capacity
ZIR-353	W12" x D32" x H5½"	Grey	45kg

Laundry Basket



Item No.	Size	Feature
WLB-01	W14½" x D15½" x H22"	3sided laundry basket, need to be mounted on door.

closet & storage

Naber Waste Bin



Item No.	Feature	Interior Opening	Volumn
WB-212	Door Mounted, Soft Close	10¼" - 10½"	1 x 32L & 1 x 1.2L
WB-216	Door Mounted, Soft Close	14¼" - 14½"	1 x 35L & 1 x 1.2L

All Waste Bin 23" Height, 20 ½" Depth



Item No.	Feature	Interior Opening	Volumn
WB-218	Door Mounted, Soft Close	16⅛" - 16⅜"	2 x 35L
WB-220	Door Mounted, Soft Close	18⅛" - 18⅜"	2 x 35L

All Waste Bin 23" Height, 20 ½" Depth

waste bin

Naber Waste Bin



Item No.	Feature	Interior Opening	Volumn
WB-324	Door Mounted, Soft Close	22 $\frac{1}{8}$ " - 22 $\frac{3}{8}$ "	2 x 35L & 1 x 21L

All Waste Bin 23" Height, 20 $\frac{1}{2}$ " Depth

waste bin

Foot Step for Waste Bin Cabinet Door



Item No.	Description	Material
WB-101	Step to open	Stainless Steel

Bottom Mounted Waste Bin



Soft-Closing, 15L + 15L Bin

Item No.	Feature	Size
WB-608S	Pull Out	W14" x D20" x H13"
WB-608DS	Door Mounted	W14" x D20" x H13"

15
15

Steel Frame / Colour: Grey



Soft-Closing, 20L + 20L Bin

Item No.	Feature	Size
WB-602S	Pull Out	W14" x D20" x H17"
WB-602DS	Door Mounted	W14" x D20" x H17"

20
20

Steel Frame / Colour: Grey



Bottom Mounted Waste Bin Soft-Closing, 20L + 10L Bin

Item No.	Feature	Size
WB-603S	Pull Out	W11" x D20" x H17"
WB-603DS	Door Mounted	W11" x D20" x H17"

20	Steel Frame / Colour: Grey
10	

waste bin



Side Mounted Waste Bin Soft-Closing, 35L + 35L Bin

Item No.	Feature	Size	Cabinet Width (Internal)
WB-641D2S	Door Mounted	W16½" x D20" x H21"	16 ¾"

35	Colour: Grey
35	



Soft-Closing, 35L + 17L + 17L Bin

Item No.	Feature	Size	Cabinet Width (Internal)				
WB-648D3S	Door Mounted	W 18¾" x D20" x H21"	18¾"				
<table border="1" data-bbox="826 1101 895 1166"> <tr> <td>35</td> <td>17</td> </tr> <tr> <td></td> <td>17</td> </tr> </table>		35	17		17	Colour: Grey	
35	17						
	17						

waste bin

Trim Pack



Advantages:

Quick to apply, ready to use and sets in under 15 seconds

One kit can be enough to bond 100 joints

Available in a handy squeeze bottle with a MitrePen

Item No.	Description
MT-AG616.4CR	3 x 50g glue/Patented MitrePen

MitreBond



Advantages:

Use with MitreBond Glue

Quick to apply, ready to use and sets in under 15 seconds

Item No.	Description
MT-AG400SP	400ml Spray Activator

MitreBond Contractor Kit



Advantages:

Quick to apply, ready to use and sets in under 15 seconds
One kit can be enough to bond 100 joints
Available in a handy squeeze bottle with an activator sprays

Item No.	Description
MT-AG414.2CR	100g glue/400ml spray activator

MitreBond



Advantages:

Use with MitreBond Glue
Quick to apply, ready to use and sets in under 15 seconds
Available in a Trim Pack - 3x50g glue + Patented MitrePen

Item No.	Description
MT-AG212.M	MitreBond Activator Pen

MitreBond



Advantages:

- Use with MitreBond Activator Pen
- Quick to apply, ready to use and sets in under 15 seconds
- Available in a Trim Pack - 3x50g glue + Patented MitrePen

Item No.	Description
MT-AG100GL	100g Bottle of MitreBond Glue

Quick Grab double sided construction tape

edging, sealants
& Adhesives



Advantages:

- Will stick to ceramics, wood, glass, plastics, brickwork, PVC etc.
- Weatherproof
- Strong initial bond strength
- Will stick to porous and non porous surfaces

Item No.	Size
MT-2POWERGRIP12	12mm - 2.5 meter
MT-2POWERGRIP25	25mm - 2.5 meter

High modulus silicone tubes

Advantages:

- Permanently flexible
- Anti-fungal formula-prevents mould growth
- Quick curing-low dirt pick
- Low viscosity for fast application
- Certified under the harmonized European standard EN15651 for facade, cold climate and sanitary applications in compliance with the Construction Product Regulation



Item No.	Description
MT-GPSTR-Clear	300ml - Clear
MT-GPSWE-White	300ml - White

Instant Nail



Advantages:

- High strength, multi-use adhesive
- Quick initial grab
- Ideal for gap filling
- Use to fix skirting boards, dado rails, door surrounds, wall panels etc.

Item No.	Description
MT-INST NAIL	300ml Bottle of Glue

edging, sealants
& Adhesives

Jowatherm



Item No.	Description
JOWAT-1	288.60 Natural hot melt pallets 20kg/bag

Jigsaw - 50 Blades/pack

edging, sealants
& Adhesives



Item No.	Description
MT-JigBlade/50 T101B	Normal Cut
MT-JigBlade/50 T101BR	Reverse Cut



HELMIBOND 895WH is a low activation temperature, for membrane pressing or vacuum forming rigid thermofoils

Item No .	Description
HEL-895WH-19L	Laminating Adhesive 18.9L (5 Gal) Metal Pail



HELMITIN HARDENER 561 is a crosslinking agent used in conjunction with waterborne polyurethane dispersions to increase the heat and water resistance, bond strength and long term performance of the adhesive.

Provides excellent heat resistance

Item No .	Description
HEL-561-hardener	Crosslinking agent with waterborne polyurethane dispersions



Fast drying with a long open time
Bonds HPL, particleboard, plywood, steel, and many plastics

Item No.	Description
HEL-1685.17OZ	High Performance Contact Adhesive Aerosol Can



Fast drying with a long open time
 Bonds HPL, particleboard, plywood, steel, and many plastics

Item No.	Description
HEL-1685.38LB	High Performance Contact Adhesive Canister 38 LB



A flammable brush/roll grade polychloroprene contact adhesive

Item No .	Description
HEL-4535-19L	Brush Grade Contact Adhesive - Amber 18.9L Metal Pail



Excellent green strength and high heat resistance for postforming application

Item No .	Description
HEL-4545-19L-CLEAR	Spray Grade Contact Adhesive - Clear (Light Brown) 18.9L Metal Pail



Excellent green strength and high heat resistance for postforming application

Item No .	Description
HEL-4545-19L-RED	Spray Grade Contact Adhesive - RED 18.9L Metal Pail



high speed edge banding, proöle wrapping
Bonds thick and thin PVC, ABS, PP and melamine edge tapes, HPL, backed and raw veneer tapes, engineered wood edging and most solid wood

Item No .	Description
HEL-480-WHITE	White Hot Melt Plt 20KG(44 LB) BAG



Bonds thick and thin PVC, ABS, PP and melamine edgetapes, HPL, backed and raw veneer tapes, engineered wood edging and most solid wood

Item No .	Description
HEL-480C-WHITE	Hot Melt Adhesive Cartridge 45/box



Bonds thick and thin PVC, ABS, PP and melamine edgetapes, HPL, backed and raw veneer tapes, engineered wood edging and most solid wood species up to ¼" thick
 Working temperature: 170°C - 220°C
 Color: Natural

Item No .	Description
HEL-482-NATURAL	Hot Melt Adhesive



Bonds thick and thin PVC, ABS, PP and melamine edgetapes, HPL, backed and raw veneer tapes, engineered wood edging and most solid wood species up to ¼" thick
 Working temperature: 170°C - 220°C
 Color: Natural

Item No .	Description
HEL-482C-NATURAL	Hot Melt Adhesive Cartridge 45 Cartridge/box



Bonds thick and thin PVC, ABS, PP and melamine edgetapes, HPL, backed and raw veneer tapes, engineered wood edging and most solid wood species up to ¼" thick
 Working temperature: 170°C - 220°C
 Color: Clear

Item No .	Description
HEL-495C-CLEAR	Hot Melt Adhesive Cartridge 45 Cartridge/box



Unylled "Seamless" Hot Melt Cartridge For HolzHer™ Edgebanders
 Opaque, unylled hot melt cartridge that blends well with light-colored substrates for undetectable glue lines on HolzHer edgebanders.

Item No .	Description
HEL-496C-WHITE	Hot Melt Adhesive 45 Cartridge/box



Bonds thick and thin PVC, ABS, PP and melamine edgetapes, HPL, backed and raw veneer tapes, engineered wood edging and most solid wood species up to ¼" thick
 Working temperature: 170°C - 220°C
 Color: Natural

Item No .	Description
HEL-497-CLEAR	Hot Melt Adhesive 20 KG/Bag



Machinery running at 16 meters/minute or faster
 Solid and enginerrd wood edging up to ¼: thick
 PVC, ABS, PP and melamine edgetapes
 Fleece-backed, paper-backed and raw veneer tapes

Item No .	Description
HEL-498-WHITE	Hot Melt Adhesive 20 KG/Bag

edging, sealants
& Adhesives



Designed to quickly remove Helmiprene & Helmistik contact adhesive residues from finished assemblies

Item No .	Description
HEL-665-19L	Contact Adhesive Cleaner 18.9L Metal Pail



Ideal for hot and cold pressing decorative overlays to particleboard and MPF
Excellent choice for wood assembly applications where water resistance is needed.

Item No .	Description
HEL-805-19L-WHITE	Hot/Cold Press & Wood Bonding PVA Adhesive 18.9L Metal Pail



A Premium quality, fast setting, unextended high strength PVA adhesive
Speciycally designed for solid wood bonding
Fast setting

Item No .	Description
HEL-847-19L-WHITE	Premium Solid Wood Bonding Adhesive 18.9L Metal Pail



Designed to quickly remove Helmiprene & Helmistik contact adhesive residues from finished assemblies

Item No .	Description
HEL-856-19L-YELLOW	Premium Fast Setting Wood Assembly Adhesive 18.9L Metal Pail



Designed primarily for use with automated and manual postforming machinery
 Can be sprayed or roll coated for use in hot bonding, hot pressing, hot roll laminating, cold pressing and "pinch roll & stack" o a t laminating applications
 Postformable

Item No .	Description
HEL-890-19L-WHITE	Post-Formable Vinyl Acetate 18.9L Metal Pail



Fast Drying
Evaporates cleanly, leaves no oily residue
Pleasant citrus smell

Item No .	Description
HEL-CITRUS CLEANER	Citrus-Extract Based Adhesive Cleaner 14 oz.

Nail Glide



Item No.	Ø	Colour
GL-1090	16mm	White

Piano Hinge



Item No.	Length	Width	Finish
SH-8010	1.8m	38mm	Steel

Pallet Wrap



Item No.	Width x Length
WRAP-L	12" x1500"

Bundling Wrap



Item No.	Width x Length
WRAP-S	3" x1500"
WRAP-M	5" x1500"

Slide Spacer (Plastic)



Item No.	Size	Colour
SP-3601WH-62	3/4"	White

Slide Spacer (Plastic)



Item No.	Size	Colour
SP-3602WH-62	1"	White

Shelf Supports (Glass)



Item No.	Ø	Colour
SP-170	5mm	Nickel/White

Shelf Supports (Glass)



Item No.	Ø	Colour
SP-14	5mm	Nickel/Clear

Shelf Supports (Clear)- No Sticking



Item No.	Ø	Colour
SP-20	5mm	Clear

Shelf Supports (Metal)



Item No.	Ø	Colour
SP-21	5mm	Zinc

Shelf Supports (Clear)- with sticking



Item No.	Ø	Colour
SP-22	5mm	Clear

Shelf Supports (Clear) - 5/8" shelf lock



Item No.	Ø	Colour
SP-23	5mm	Clear

Shelf Supports (Clear) - 3/4" shelf lock



Item No.	Ø	Colour
SP-24	5mm	Clear

Shelf Supports (Plastic)



Item No.	Size	Colour
SP-25	lock 5/8" shelf	White

Shelf Supports (5mm)



Item No.	Ø	Colour
SP-27	5mm	Nickel

Shelf Supports (7mm)



Item No.	Ø	Colour
SP-28	7mm	Nickel

Shelf Supports - Heavy Duty



Item No.	Ø	Colour
SP-55	6mm	Brush Brown

Shelf Supports (Metal)



Item No.	Ø	Colour
SP-05	5mm	Nickel

Angle Brackets



Item No.	Size	Colour
BK-058	3/4" x 3/4" x 5/8"	Zinc

Angle Brackets



Item No.	Size	Colour
BK-134	1-1/8" x 1-1/8" x 1/4"	Zinc

Angle Brackets



Item No.	Size	Colour
BK-751	1-1/8" x 1-1/8"	Zinc

Drawer Lock Keyed Alike



Item No.	Size	Colour
LK-1118	1-1/8"	Zinc

CAM Lock Keyed Alike



Item No.	Size	Colour
LK-2078	7/8"	Zinc

Bumper



Item No.	Ø	Colour
BP-08	8mm x 2mm	Clear
BP-42	8mm x 2mm	Clear

Bumper



Item No.	Ø	Colour
BP-19C	12.7mm x 3.5mm	Clear

Soap Tray



Item No.	Size	Colour
TP-12	W12" x D2-3/8" x H3"	White
TP-15	W15" x D2-3/8" x H3"	White

Soap Tray



Item No.	Size	Colour
TP-11	W11" x D2-3/8" x H3"	White
TP-14	W15" x D2-3/8" x H3"	White

Cable Entry



Item No.	Material	Fits hole	Colour
SG-8130	Zinc-Alloy	55mm Ø	Satin Nickel
SG-8130B	Zinc-Alloy	75mm Ø	Satin Nickel

Tip Over Hinge



Item No.	Description
TP-01A	One pair, tip over for soap tray

Glass Racks



Item No.	Size
WGH-002	W4 $\frac{1}{4}$ " x D13 $\frac{1}{2}$ " x H2 $\frac{5}{8}$ "
WGH-004	W8 $\frac{1}{4}$ " x D13 $\frac{1}{2}$ " x H2 $\frac{5}{8}$ "
WGH-006	W16" x D13 $\frac{1}{2}$ " x H2 $\frac{5}{8}$ "

Push Open Pistons



Item No.	Ø	Depth	Description
BP-6060	10mm	80mm	with magnetic
BP-6070	10mm	80mm	no magnetic

Push Open Pistons



Item No.	Size	Description
BP-0605W	W15xD83XH20	no magnetic



Item No.	Size	Description
BP-0620W	W15xD85XH20	with magnetic

M-Push

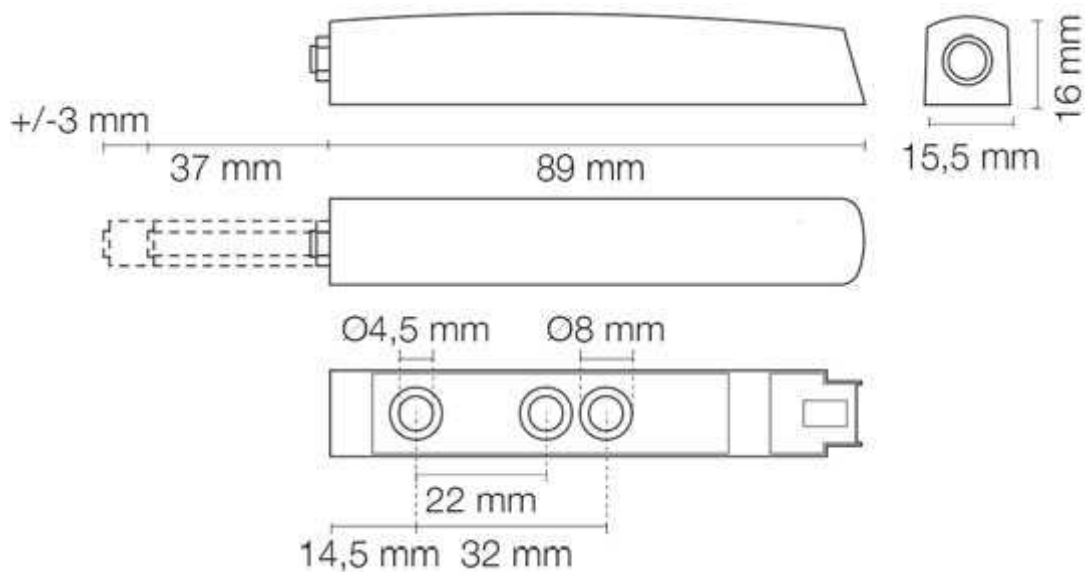

Item No.	Size	Description	Colour
MP-98MW	W15.5xD129XH16mm	with magnet	White
MP-98MG	W15.5xD129XH16mm	with magnet	Light Grey
MP-99W	W15.5xD129XH16mm	with buffer	White
MP-99G	W15.5xD129XH16mm	with buffer	Light Grey

Soft Closing Door Dampers

Soft Closing

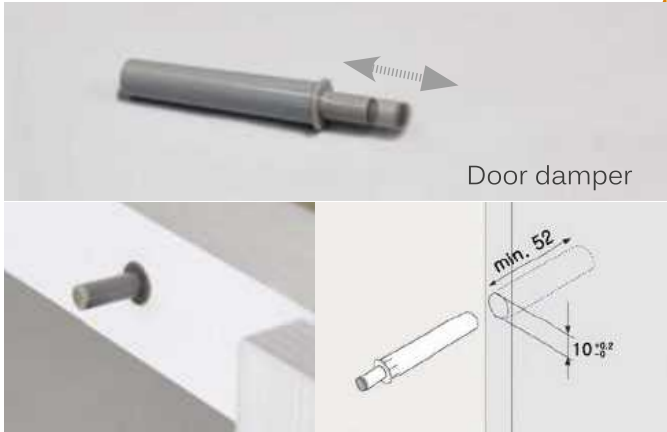

Door damper

Item No.	Description
DP-BT031	Damper base, tube shape
DP-LD012	Damper, light duty



Item No.	Description
BP-2200-001	Soft-Close System, tube shape

Item No.	Description
BP-2200-003	Soft-Close System, wing shape

Lid Stay



Item No.	Description
LS-03	Mechanical Lift Up Door Stay

Gas Lift Stays - Push Up



Item No.	Description
LS-XJ100	Gas Door Stay, 100N
LS-XJ80	Gas Door Stay, 90N

Door Stays - Push Down



Item No.	Colour
LS-14	Zinc Alloy

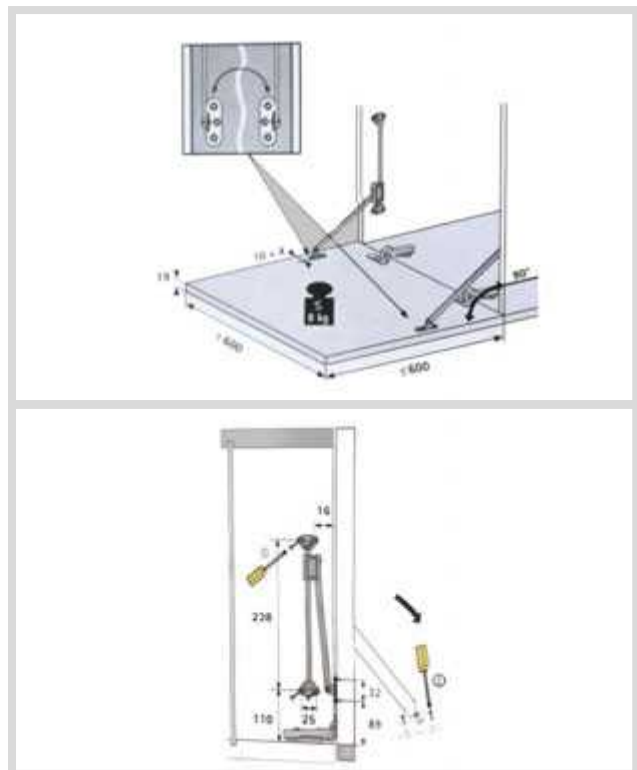

www.EurojytCanada.com

Premium Hardware Solutions



2024

JC Furniture Hardware Corp.
Toronto, Ontario

7055 Fir Tree Drive
Mississauga, ON
L5S 1J7
Canada

T: 905.405.8700
F: 905.405.8705
E: service@EurojytCanada.com

Eurofit Hardware Inc.
Vancouver, BC

#6&7-3571 Viking Way
Richmond, BC
V6V 1W1
Canada

T: 604.270.3837
F: 604.273.3839
E: eurojyt@EurojytCanada.com

Quincaillerie Euroline Inc.
Montreal, QC

1160 Rue Beaulac
Montreal, Quebec
H4R 1R7
Canada

T: 514.439.1657
F: 514.419.4095
E: euroline@eurojytcanada.com