

KINVARO

L-80 parallel lift flap fitting



- Holds flap securely in any position
 - Extremely smooth movement
 - Adjustable spring force
 - Integrated adjustable closing damper
 - Flap with 3-dimensional adjustment – height, side, angle: direct adjustment ± 1.5 mm
 - Allows the use of cornices, pelmets and pelmet lights
 - Wide range of applications for many different flap materials
 - Fast, tool-free clip fitting of the front
 - Pre-assembled Euro screws and positioning pins for easy mounting
- of the fitting on the side wall
 - High stability
 - Weight 1.9 to 14.6 kg
 - Range of flaps:
 - Width: 450–1200 mm
 - Height: 370–600 mm
 - Cover caps in grey, similar to RAL 7045



APPLICATION RANGE

Cabinet height	Guide lever	Flap weight incl. handle (kg)		
		Spring A	Spring B	Spring C
370–389	Type 2	2.3–6.0	5.5–9.0	8.5–9.6
390–409	Type 3	2.1–5.5	5.0–8.5	8.0–10.1
410–429	Type 4	1.9–5.0	4.5–8.0	7.5–14.6
430–600	Type 5	2.0–4.5	4.0–7.5	7.0–14.6

ORDER INFORMATION

Kinvaro L-80 set						
Cabinet height				Cover cap, grey		
				Spring A	Spring B	Spring C
370–389				-	-	-
390–409				F152147441	F152145251	F152145252
410–429				F152147442	F152145281	-
430–600				F152147443	F152145253	F152145254

Kinvaro L-80 set comprises:

- 1 Fitting, right and left (1x)
 - 2 Cover caps, right and left (1x)
 - 3 1090 mm cross bar for cutting to length (1x)
 - 4 Sliding sleeves (2x)
 - 5 Mounting plates (2x)
- Paper template (1x)
Installation instructions (1x)

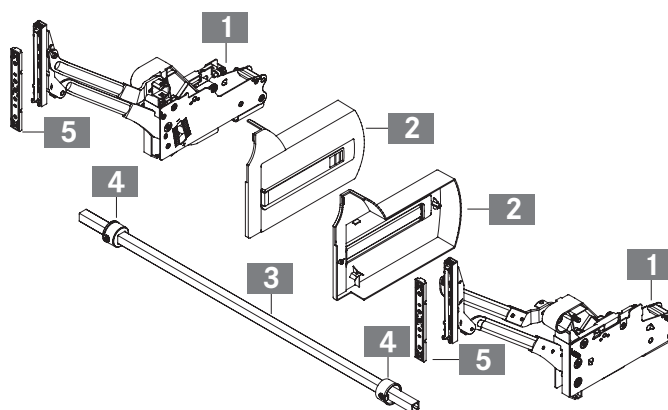

PAGE REFERENCES

Kinvaro L-80 adjustment options	286
Assembly aids	656

ASSEMBLY AND INSTALLATION INSTRUCTIONS

All dimensions in millimetres

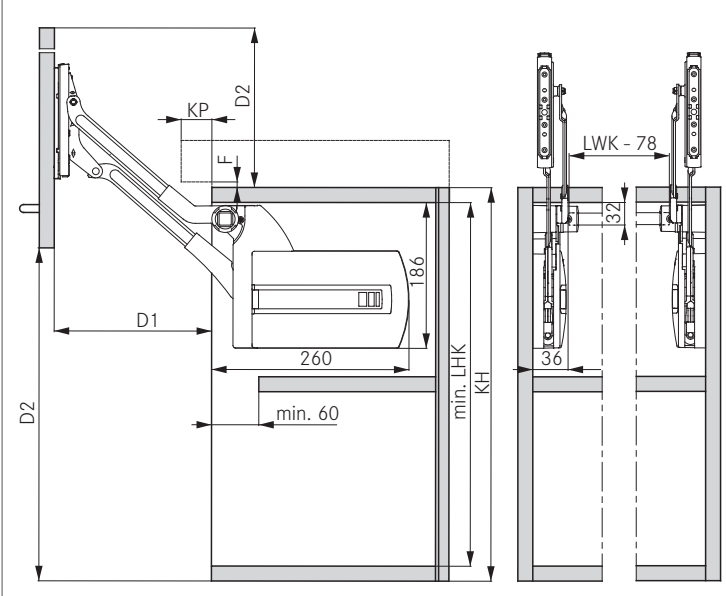
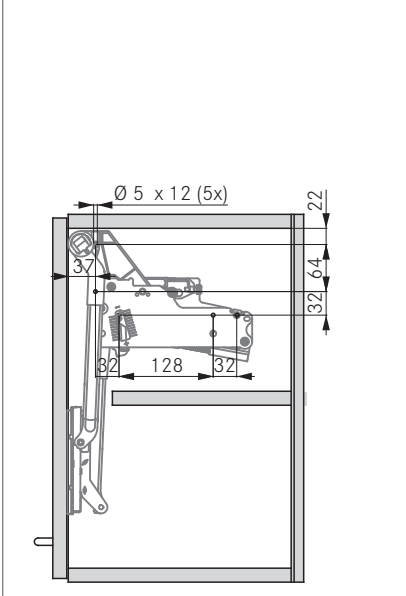
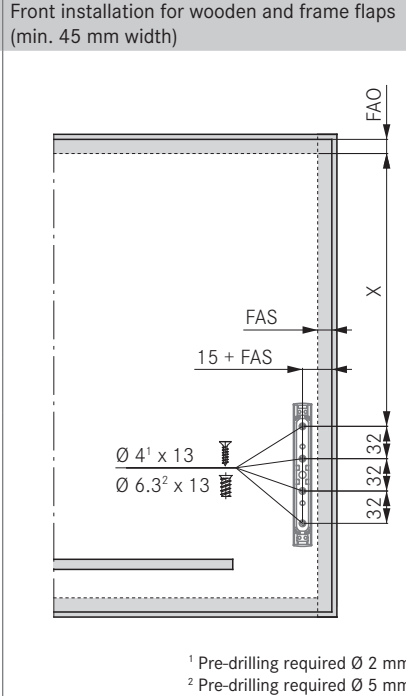
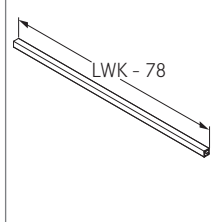
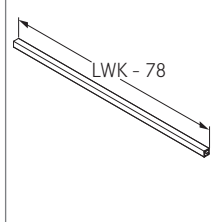
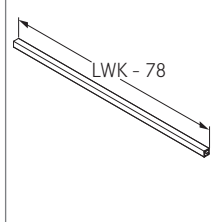
Required space	Side wall drilling positions	Front opening position																														
		<table border="1"> <thead> <tr> <th>Type</th> <th>Min. LHK</th> <th>D1</th> <th>D2</th> </tr> </thead> <tbody> <tr> <td>2</td> <td>332</td> <td>176</td> <td>337</td> </tr> <tr> <td>3</td> <td>352</td> <td>191</td> <td>370</td> </tr> <tr> <td>4</td> <td>372</td> <td>206</td> <td>403</td> </tr> <tr> <td>5</td> <td>392</td> <td>221</td> <td>436</td> </tr> </tbody> </table> <table border="1"> <thead> <tr> <th colspan="2">Cornice projection</th> </tr> <tr> <th>F</th> <th>KP max.</th> </tr> </thead> <tbody> <tr> <td>2</td> <td>22</td> </tr> <tr> <td>3</td> <td>35</td> </tr> <tr> <td>4</td> <td>39</td> </tr> </tbody> </table>	Type	Min. LHK	D1	D2	2	332	176	337	3	352	191	370	4	372	206	403	5	392	221	436	Cornice projection		F	KP max.	2	22	3	35	4	39
Type	Min. LHK	D1	D2																													
2	332	176	337																													
3	352	191	370																													
4	372	206	403																													
5	392	221	436																													
Cornice projection																																
F	KP max.																															
2	22																															
3	35																															
4	39																															
	<p>Front installation for wooden and frame flaps (min. 45 mm width)</p>  <p>¹ Pre-drilling required Ø 2 mm ² Pre-drilling required Ø 5 mm</p>	<table border="1"> <thead> <tr> <th>KH</th> <th>Type</th> <th>X</th> </tr> </thead> <tbody> <tr> <td>370-389</td> <td>2</td> <td>210</td> </tr> <tr> <td>390-409</td> <td>3</td> <td>230</td> </tr> <tr> <td>410-429</td> <td>4</td> <td>250</td> </tr> <tr> <td>430-600</td> <td>5</td> <td>270</td> </tr> </tbody> </table> <table border="1"> <thead> <tr> <th colspan="2">Cross bar cutting dimensions</th> </tr> </thead> <tbody> <tr> <td colspan="2"></td> </tr> </tbody> </table>	KH	Type	X	370-389	2	210	390-409	3	230	410-429	4	250	430-600	5	270	Cross bar cutting dimensions														
KH	Type	X																														
370-389	2	210																														
390-409	3	230																														
410-429	4	250																														
430-600	5	270																														
Cross bar cutting dimensions																																
																																
<p>Calculation of flap weight</p> <p>Flap width x flap height x flap thickness x density ¹ + weight of handle ² = weight of flap</p> <p>¹ Densities: MDF board 0.85 kg/dm³, chipboard 0.65 kg/dm³, spruce/pine 0.45 kg/dm³</p> <p>² For bar handles, allow 0.1 kg per 100 mm of handle length. We recommend a trial fitting</p>																																

WARNING

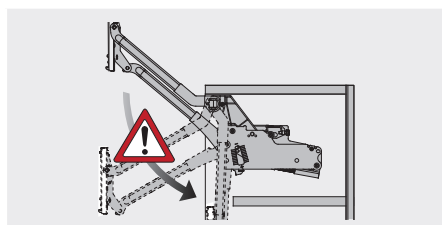

Important!
Caution – risk of injury!
Fitting is spring-tensioned!

LEGEND

- D Distance
- F Reveal
- FAO Front overlay, top
- FAS Front overlay, side
- KH Cabinet height
- KP Cornice
- LHK Inside cabinet height
- LWK Inside cabinet width

