

VISIT US ONLINE AT:

sharkninja.sg

sharkninja.my

Or follow us on any of our social media pages:



SG sharkninja.sg | **MY** sharkninja.my



@ninjakitchensg | @ninjakitchenmy



@ninjakitchenasia

NOTE: Save these instructions. Keep for future reference.



This marking indicates this product should not be disposed of with other household waste. To prevent possible harm to the environment or human health from uncontrolled waste disposal, recycle it responsibly to promote the sustainable reuse of material sources. To return your used device, please use the return and collection systems or contact the retailer where this product was purchased. They can take this product for environmentally safe recycling.

Proudly distributed by:

Mann & Noble Asia Pte.Ltd.
600 North Bridge Road #23-01 Parkview Square
Singapore 188778

Mann & Noble Retail Brands Malaysia SDN. BHD.
23-8, Menara Permata Damansara (Oval Damansara),
No. 685, Jalan Damansara, Kuala Lumpur
Wilayah Persekutuan, 60000, Malaysia

SG: +65 800 120 5111
MY: +60 1800 803 915

sharkninja.sg
sharkninja.my

Illustrations may differ from actual product. We are constantly striving to improve our products, therefore the specifications contained herein are subject to change without notice.

FOODI & NINJA are registered trademarks of SharkNinja Operating LLC.
COOK & CRISP, SMARTLID & SMARTLID SLIDER are trademarks of SharkNinja Operating LLC.

© 2023 SharkNinja Operating LLC

OL550SM_IB_MP_Mv8



NINJA®

Foodi®

SmartLid™

Multi-Cooker

OL550SM

INSTRUCTIONS



SG sharkninja.sg | **MY** sharkninja.my

THANK YOU

for purchasing the Ninja® Foodi® SmartLid™ Multi-Cooker

REGISTER YOUR PURCHASE



SG sharkninja.sg | MY sharkninja.my

RECORD THIS INFORMATION

Model Number: _____

Serial Number: _____

Date of Purchase: _____
(Keep receipt)

Store of Purchase: _____

TECHNICAL SPECIFICATIONS

Voltage: 230V~, 50Hz

Watts: 1460W

TIP: You can find the model and serial numbers on the QR code label on the back of the unit by the power cord.

PRODUCT REGISTRATION:

Please visit **SG** sharkninja.sg | **MY** sharkninja.my or call +65 800 120 5111 (Singapore) +60 1800 803 915 (Malaysia) to register your new Ninja® product within 28 days of purchase. You will be asked to provide the store name, date of purchase and model number along with your name and address.

The registration will enable us to contact you in the unlikely event of a product safety notification.

CONTENTS

Important Safeguards	2
Parts & Accessories	6
Accessory Assembly Instructions	8
Using the SmartLid Slider™	8
Using the Control Panel	9
Cooking Functions	9
Operating Buttons	9
Before First Use	10
Installing the Condensation Collector	10
Removing & Reinstalling the Anti-Clog Cap	10
Using the Ninja® Foodi® Max SmartLid™ Multi-Cooker	11
Using the Pressure Cooking Functions	11
Water Test: Getting Started Pressure Cooking	11
Natural Pressure Release vs. Quick Pressure Release	12
Pressurising	12
Using the Pressure Function	12
Using the Combi-Steam Mode Functions	14
Steam Air Fry	14
Steam Bake	15
Using the Air Fry/Hob Functions	16
Air Fry	16
Grill	17
Bake	17
Dehydrate	18
Sear/Sauté	18
Steam	19
Slow Cook	19
Yogurt	20
Cleaning & Maintenance	21
Cleaning: Dishwasher & Hand-Washing	21
Removing & Reinstalling the Silicone Ring	21
Cleaning the Lid	22
Troubleshooting Guide	23
Helpful Tips	24

IMPORTANT SAFEGUARDS

HOUSEHOLD USE ONLY • READ ALL INSTRUCTIONS BEFORE USE

⚠ WARNING

- 1** To eliminate a choking hazard for young children, discard all packaging materials immediately upon unpacking.
- 2** This appliance can be used by persons with reduced physical, sensory or mental capabilities or lack of experience or knowledge if they have been given supervision and instruction concerning use of the appliance in a safe way and understand the hazards involved.
- 3** Keep the appliance and its cord out of reach of children. **DO NOT** allow children to play with or use the appliance. Close supervision is necessary when used near children.
- 4** Spilled food can cause serious burns. **DO NOT** let cord hang over edges of tables or worktops or place appliance on or near hot surfaces, on or near a gas or electric burner, or in a heated oven.
- 5** **DO NOT** use the appliance without the cooking pot installed.
- 6** **NEVER** connect this appliance to an external timer switch or separate remote-control system.
- 7** Before placing removable cooking pot in the cooker base, ensure pot and cooker base are clean and dry by wiping with a soft cloth.
- 8** When removable cooking pot is empty, **DO NOT** heat it for more than 10 minutes. Doing so may damage the cooking surface.
- 9** **DO NOT** use this appliance for deep-frying.
- 10** **DO NOT** cover the pressure valves.
- 11** **DO NOT** sauté or fry with oil while pressure cooking.
- 12** Caution should be used when searing meats and sautéing. Keep hands and face away from the removable cooking pot, especially when adding new ingredients, as hot oil may splatter.
- 13** This appliance is for household use only. **DO NOT** use this appliance for anything other than its intended use. **DO NOT** use in moving vehicle or boats. **DO NOT** use outdoors. Misuse may cause injury.
- 14** Intended for worktop use only. Ensure the surface is level, clean, and dry. **DO NOT** place the appliance near the edge of a worktop during operation. **DO NOT** place appliance on electric hob.
- 15** **DO NOT** use the appliance if there is damage to the power cord or plug. Regularly inspect the appliance and power cord. If the appliance malfunctions or has been damaged in any way, immediately stop use and call Customer Service.
- 16** **ALWAYS** ensure the appliance is properly assembled before use.
- 17** Before use, **ALWAYS** check pressure release valve and float valve for clogging or obstruction, and clean them if necessary. Foods such as apple sauce, cranberries, pearl barley, oatmeal or other cereals, split peas, noodles, macaroni, rhubarb, or spaghetti can foam, froth, and splutter when pressure cooked, clogging the pressure release valve. These and similar expanding foods (such as dried vegetables, beans, grains, and rice) should not be cooked in a pressure cooker, except when following a Ninja® Foodi® recipe.
- 18** When pressure cooking foods that expand (such as dried vegetables, beans, grains, rice, etc.) **DO NOT** fill pot more than halfway, or as otherwise instructed in a Ninja® Foodi® recipe.
- 19** **DO NOT** cover the top air intake vent or rear air outlet vent while lid is closed. Doing so will prevent even cooking and may damage the unit or cause it to overheat.
- 20** To prevent risk of explosion and injury, use only a Foodi® Multicooker silicone ring. Make sure silicone ring is installed and lid is properly closed before operating. **DO NOT** use if torn or damaged. Replace silicone ring before using.
- 21** **DO NOT** use accessory attachments not recommended or sold by SharkNinja. **DO NOT** place accessories in a microwave, toaster oven, convection oven, or conventional oven, or on a ceramic cooktop, electrical coil, gas burner range, or outdoor grill. The use of accessory attachments not recommended by SharkNinja may cause fire, electric shock, or injuries.
- 22** When using this appliance, provide at least 6 inches (15.25cm) of space above and on all sides for air circulation.
- 23** **ALWAYS** follow the maximum and minimum quantities of liquid as stated in instructions and recipes.
- 24** To avoid possible steam damage, place the unit away from walls and cabinets during use.
- 25** **NEVER** use SLOW COOK setting without food and liquids in the removable cooking pot.
- 26** **DO NOT** move the appliance when in use. Only move the appliance with slider in PRESSURE position to keep lid from unintentionally opening.
- 27** Prevent food contact with heating elements. **DO NOT** overfill or exceed the MAX fill level of the pot and the Cook & Crisp™ Basket or Plate. Overfilling may cause personal injury or property damage or affect the safe use of the appliance.
- 28** **DO NOT** use this unit to cook instant rice.
- 29** Electrical socket voltages can vary, affecting the performance of your product. To prevent possible illness, use a probe to check that your food is cooked to the temperatures recommended.
- 30** Should the unit emit black smoke, unplug immediately and wait for smoking to stop before removing the cooking pot and Cook & Crisp™ Basket or Plate.
- 31** **DO NOT** touch hot surfaces. Appliance surfaces are hot during and after operation. To prevent burns or personal injury, **ALWAYS** use protective hot pads or insulated oven gloves and use available handles and knobs.
- 32** Extreme caution must be used when moving an appliance containing hot oil or other hot liquids and/or if the cooker is under pressure. Improper use, including moving the cooker, may result in personal injury such as serious burns. When using this appliance to pressure cook, ensure the lid is properly closed and locked in position before use. Foods are under extreme pressure during pressure cooking. Failure to follow all instructions regarding proper usage of the product may result in unintended contact with hot foods or liquids that have been pressurised, resulting in serious burns.
- 33** When unit is in operation, hot steam is released through the air exhaust vent. Place unit so vent is not directed toward the power cord, electrical sockets, cabinets or other appliances. Keep your hands and face at a safe distance from vent.

SAVE THESE INSTRUCTIONS

IMPORTANT SAFEGUARDS

HOUSEHOLD USE ONLY • READ ALL INSTRUCTIONS BEFORE USE

- 34 DO NOT** tamper with, disassemble, or otherwise remove the float valve or pressure release assembly.
- 35 DO NOT** attempt to open the lid during or after pressure cooking until all internal pressure has been released through the pressure release valve and the unit has cooled slightly. Open lid promptly to avoid re-pressurisation of the inner pot.
- 36** When using SLOW COOK setting, **ALWAYS** keep the lid closed.
- 37** If the lid will not unlock to open, this indicates the appliance is still under pressure. Any pressure remaining can be hazardous. Let unit naturally release pressure or press the Steam Release button to release steam. Take care to avoid contact with the releasing steam to avoid burns or injury. When steam is released the UI will show OPN LID indicating the lid can be opened. If steam does not release when the pressure release valve is moved to vent, unplug the unit from the wall and let the unit naturally release pressure.
- 38** Serious burns can result from the steam and hot foods inside the inner pot. **ALWAYS** keep hands, face, and other body parts away from the pressure release valve prior to or during pressure release and when opening the lid after cooking.
- 39** The cooking pot, Cook & Crisp™ Basket or Plate, and reversible rack become extremely hot during the cooking process. Avoid hot steam and air while removing the cooking pot and Cook & Crisp™ Basket or Plate from the appliance, and **ALWAYS** place them on a heat-resistant surface after removing. **DO NOT** touch accessories during or immediately after cooking.
- 40 ONLY** lift the lid from the handle on the front of the unit. **DO NOT** lift lid from side area as scalding steam will release.
- 41** Removable cooking pot can be extremely heavy when full of ingredients. Care should be taken when lifting pot from cooker base.
- 42 DO NOT** touch accessories, including the probe (if included with the model), during or immediately after cooking, as they become extremely hot during the cooking process. To prevent burns or personal injury, **ALWAYS** use care when interfacing with product. Use long-handed utensils and protective hot pads or insulated oven gloves.
- 43** Cleaning and user maintenance should not be done by children.
- 44** Allow unit to cool before cleaning, disassembly, putting in or taking off parts and storage.
- 45** To disconnect, turn unit off, then unplug from socket when not in use and before cleaning.
- 46 DO NOT** clean with metal scouring pads. Pieces can break off the pad and touch electrical parts, creating a risk of electric shock.
- 47** Please refer to the Cleaning & Maintenance section for regular maintenance of the appliance.
- 48 NEVER** put the cooker base in the dishwasher or immerse it in water or any other liquid.



Indicates to read and review instructions to understand operation and use of product.



Indicates the presence of a hazard that can cause personal injury, death or substantial property damage if the warning included with this symbol is ignored.



Take care to avoid contact with hot surface. Always use hand protection to avoid burns.



For indoor and household use only.

SAVE THESE INSTRUCTIONS

PARTS & ACCESSORIES

Accessories Included

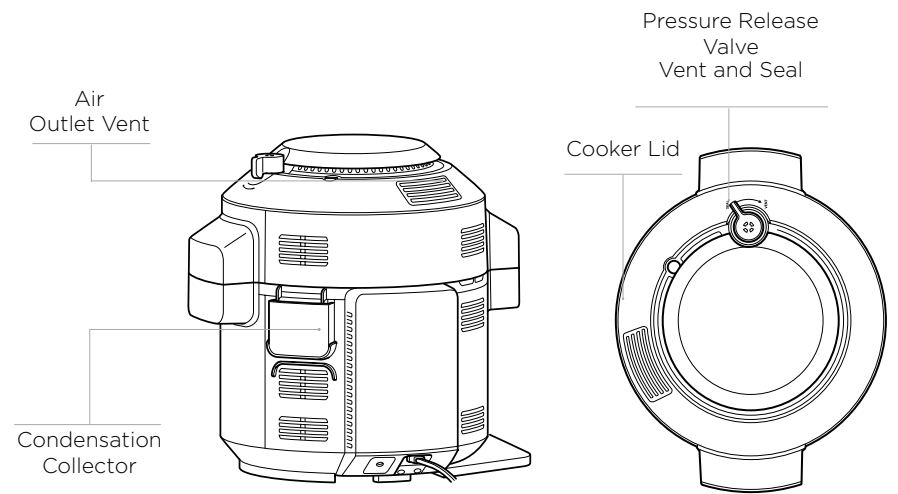
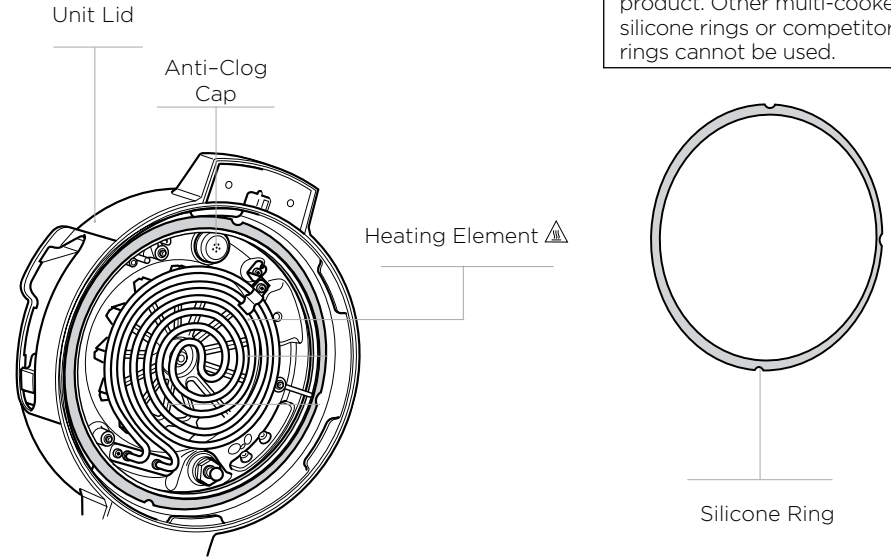
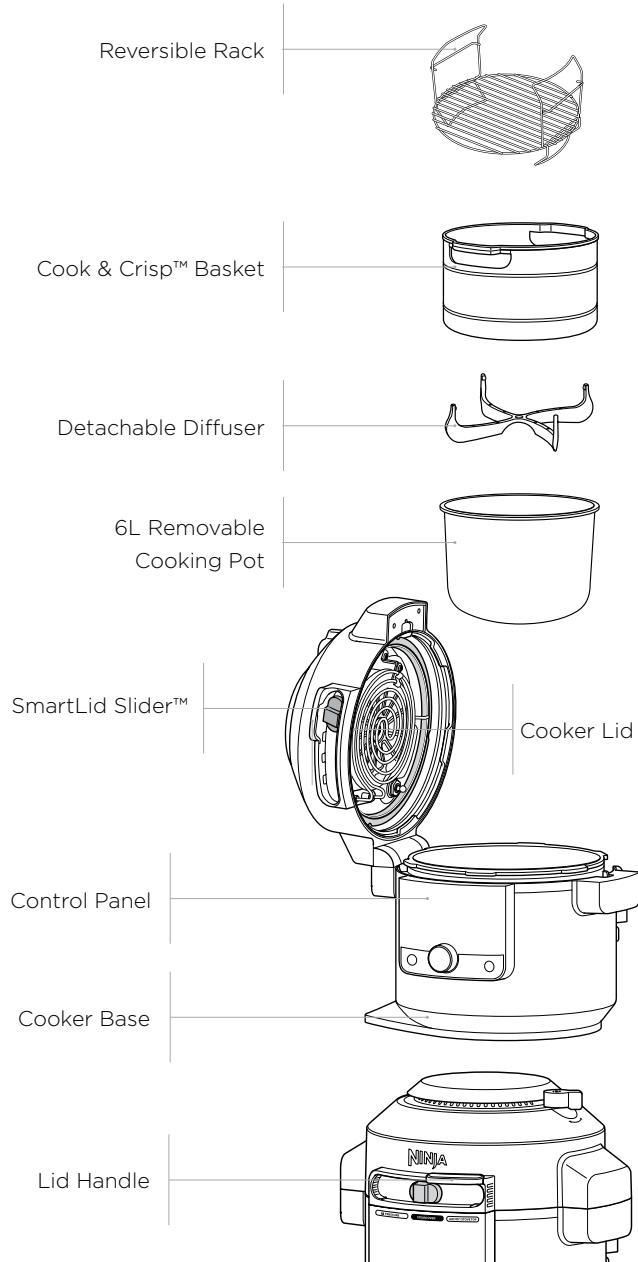

To order additional parts and accessories, visit **SG** sharkninja.sg or **MY** sharkninja.my

ACCESSORY ASSEMBLY INSTRUCTIONS

COOK & CRISP™ BASKET

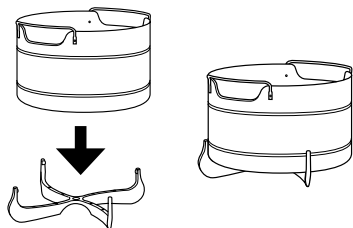

- 1 To remove diffuser for cleaning, pull 2 diffuser fins off the groove on the basket, then pull diffuser down firmly.

NOTE: Diffuser helps with airflow and should always be installed on the basket before use.

- 2 To assemble the Cook & Crisp™ Basket, place basket on top of diffuser and press down firmly.

USING THE SMARTLID SLIDER™

The slider allows you to switch between cook modes and notifies the lid which function you are using.

- Pressure
- Combi-Steam mode
- Air Fry/Hob

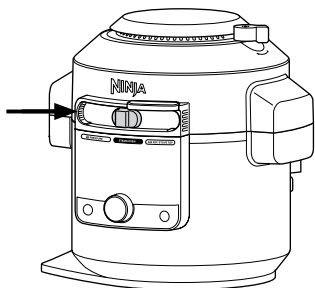

HOW TO OPEN AND CLOSE THE LID

Use the handle that is located above the slider to open and close the lid at all times.

You can open and close the lid when the slider is in the COMBI-STEAM mode and AIR FRY/HOB position. When the slider is in the PRESSURE position, the lid cannot be opened. If there is no pressure in the unit, move the slider to the COMBI-STEAM mode or AIR FRY/HOB position to open the lid.

NOTE: The lid will not unlock until the unit is completely depressurised. The smart slider will not slide to the right until the unit is completely depressurised. The unit will display "OPN LID" when unit is depressurised.

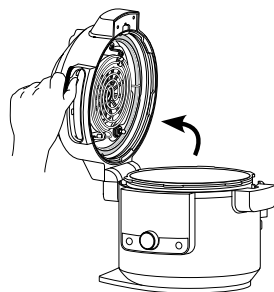

USING THE CONTROL PANEL

COOKING FUNCTIONS

PRESSURE: Cook food quickly while maintaining tenderness.

STEAM AIR FRY: Crisp vegetables and proteins with little to no oil.

STEAM BAKE: Bake fluffy cakes and sweet treats.

AIR FRY: Give food crispness and crunch with little to no oil.

GRILL: Use high temperature to caramelize and brown your food.

BAKE: Use the unit like an oven for baked treats and more.

DEHYDRATE: Dehydrate meats, fruits and vegetables for healthy snacks.

SEAR/SAUTÉ: Use the unit as a hob for browning meats, sautéing vegetables, simmering sauces and more.

STEAM: Gently cook delicate foods at a high temperature.

SLOW COOK: Cook your food at a lower temperature for a longer period of time.

YOGURT: Pasteurise and ferment milk for creamy homemade yogurt.

KEEP WARM: When using steam, slow cook and pressure the unit will switch to KEEP WARM at the end of the cycle. Press the KEEP WARM button after the function has started to disable this automatic transition.

NOTE: If running for 1 hour or less, the clock will count down by minutes and seconds. If running for more than 1 hour, the clock will count down by minutes only. This function will time out after 12 hours.

OPERATING BUTTONS

SMARTLID SLIDER™: As you move the slider, the available functions for each mode will illuminate.

DIAL: Once you've chosen a mode, use the dial to scroll through the available functions until your desired function is highlighted.

LEFT ARROWS: Press these to choose a cook temperature. Use the left arrows as well to set the internal outcome when using PRESET, and MANUAL buttons.

RIGHT ARROWS: Press these to choose a cook time. Use these arrows to set the food

START/STOP button: Press to start cooking. Pressing the button while the unit is cooking will stop the current cooking function.

⏻ (POWER): The Power button shuts the unit off and stops all cooking modes.

BEFORE FIRST USE

- 1 Remove and discard any packaging material, stickers and tape from the unit.
- 2 Pay particular attention to operational instructions, warnings and important safeguards to avoid any injury or property damage.
- 3 Wash the silicone ring, removable cooking pot, Cook & Crisp™ Basket, reversible rack and condensation collector in warm, soapy water, then rinse and dry thoroughly. **NEVER** clean the cooker base in the dishwasher.
- 4 The silicone ring is reversible and can be inserted in either direction. Insert the silicone ring around the outer edge of the lid. Ensure it is fully inserted and lies flat under the silicone ring rack.
- 5 Use long-handed utensils and protective hot pads or insulated oven gloves when removing foods.

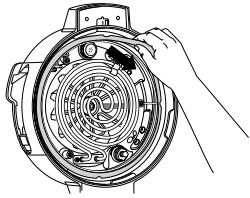

INSTALLING THE CONDENSATION COLLECTOR

To install the condensation collector, slide it into the slot on the cooker base. Slide it out to remove it for hand-washing after each use.

NOTE: Make sure to empty out excess water collected in the condensation collector after cooking.

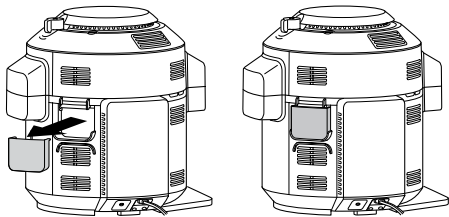

REMOVING & REINSTALLING THE ANTI-CLOG CAP

The anti-clog cap protects the inner valve of the pressure lid from clogging and protects users from potential food splatters. It should be cleaned after every use with a cleaning brush.

To remove it, hold the anti-clog cap between your thumb and bent index finger, then rotate your wrist clockwise. To reinstall, position it in place and press down. Make sure the anti-clog cap is in the correct position before using the unit.

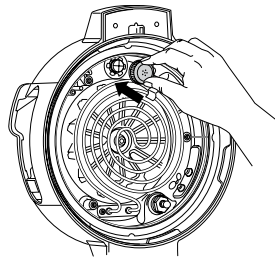
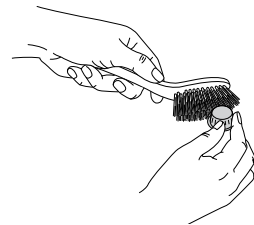

NOTE: Prior to each use, make sure the silicone ring is well-seated in the silicone ring rack and the anti-clog cap is mounted properly on the pressure release valve.

USING THE PRESSURE COOKING FUNCTIONS

WATER TEST: GETTING STARTED PRESSURE COOKING

It is recommended that first-time users do the water test to familiarise themselves with pressure cooking.

- 1 Place the pot in the cooker base and add 700ml of room-temperature water to the pot.

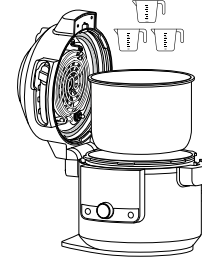

- 2 Close the lid and move slider to the PRESSURE position.

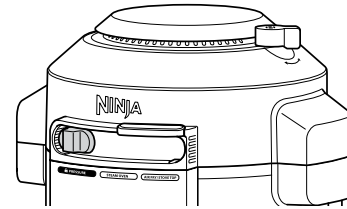

- 3 Make sure the pressure release valve is in the SEAL position.

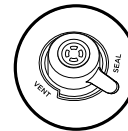

SEAL
for Pressure functions

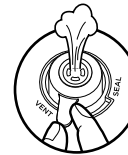

VENT
for all other functions and all other slider positions

NOTE: Valve will be loose when fully installed.

- 4 The unit will default to high (Hi) pressure. Use the right down arrow to adjust the time to 2 minutes. Press START/STOP to begin.

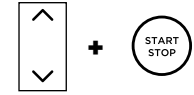

- 5 This display will show "PrE" and a progress bar indicating the unit is building pressure. When the unit is fully pressurised, the timer will start counting down.



NOTE: Time to pressure will vary based on quantity and temperature of ingredients, along with selected pressure level.

- 6 When cook time reaches zero, the unit will beep and display "End" before automatically quick releasing the pressurised steam. A warning chime will sound, indicating the pressure release valve is about to open. When the pressure release valve opens, steam will escape from it. As soon as the unit reads "OPN Lid", move the slider to the right to unlock the lid. Then open the lid.

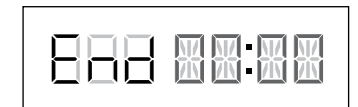

NOTE: The unit will switch to KEEP WARM mode and the heating element will remain on.

USING THE PRESSURE COOKING FUNCTIONS - CONT

NATURAL PRESSURE RELEASE VS. QUICK PRESSURE RELEASE

NATURAL: When pressure cooking is complete, steam will naturally release from the unit as it cools down. This can take up to 20 minutes or more, depending on the amount of liquid and food in the pot. During this time, the unit will switch to Keep Warm mode. Press the KEEP WARM button if you would like to turn Keep Warm mode off. When natural pressure release is complete, the unit will display "OPN Lid".

DELAYED: Use ONLY if your recipe calls for it. When pressure cooking is complete and the KEEP WARM light is on, turn the pressure release valve to the VENT position to instantly release pressure through the valve.

Even after releasing pressure naturally or using the pressure release valve, some steam will remain in the unit and will escape when the lid is opened. For recipes that require more time at pressure once the cook time has ended (for example, rice and grains).



NOTE: For larger food loads that require more depressurisation, you can release pressure by moving the valve to the VENT position.

PRESSURISING

As pressure builds in the unit, the control panel display will show "PrE" and progress bars. Time to pressure varies based on the amount and temperature of ingredients as well as liquid in the pot. For safety, the lid will lock as the unit pressurises and it will not unlock until pressure is released. Once the unit has reached full pressure, cooking will begin and the timer will start counting down.

USING THE PRESSURE FUNCTION

To turn on the unit, plug the power cord into a wall socket, then press the button.

Pressure

- 1 Place ingredients and at least 250ml of liquid in the pot, as well as any necessary accessory. **DO NOT** fill the pot past the PRESSURE MAX line.

NOTE: Unit will not pressurise if there is not enough liquid.

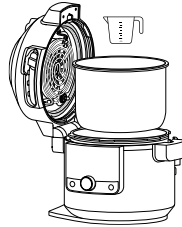

NOTE: When cooking rice, beans or other ingredients that expand, **DO NOT** fill the pot more than halfway.

- 2 Close the lid, then turn the pressure release valve to the SEAL position.

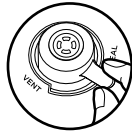

- 3 Move the slider to PRESSURE. Use the up and down arrows to the left of the display to select Hi or LO.



- 4 Use the up and down arrows to the right of the display to adjust the cook time in minute increments up to 1 hour and then 5-minute increments from 1 hour to 4 hours.

NOTE: If running for 1 hour or less, the clock will count down by minutes and seconds. If running for more than 1 hour, the clock will count down by minutes only.

- 5 Press START/STOP to begin cooking. The unit will begin building pressure. The display will show "PrE" and a progress bar. The timer will begin counting down when the unit is fully pressurised.



NOTE: Time to pressure varies depending on the selected pressure, current temperatures of the cooking pot and temperature/quantity of the ingredients.

- 6 When cook time reaches zero, turn the pressure release valve to VENT position.

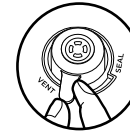

NOTE: After cooking is complete, you may press KEEP WARM to turn the KEEP WARM mode off. Or press the START/STOP button.

- 7 When the unit displays "OPN Lid," it has depressurised and you can move the slider to the right to open the lid.

USING THE COMBI-STEAM MODE FUNCTIONS

To turn on the unit, plug the power cord into a wall socket, then press the  button.

NOTE: The position of the pressure release valve does not matter. It can be in the SEAL or VENT position.

Steam Air Fry

- 1 Place ingredients in the pot with Cook & Crisp™ Basket or the reversible rack. Ensure there is liquid in the pot to create steam. Close the lid.
- 2 Move slider to COMBI-STEAM mode, then use the dial to select STEAM AIR FRY. The default temperature and time settings will display. Use the up and down arrows to the left of the display to choose a temperature in 5°C increments between 150°C and 240°C.

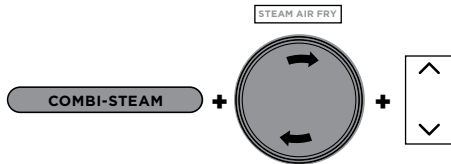

- 3 Use the up and down arrows to the right of the display to adjust the cook time in minute increments up to 1 hour.
- 4 Press START/STOP to begin cooking.
- 5 The display will show "PrE" and progress bars indicating the unit is building steam. The time to steam depends on the amount of ingredients in the pot.



- 6 When the unit reaches the appropriate steam level, the display will show the set temperature and the timer will begin counting down.

- 7 When cook time reaches zero, the unit will beep and display "End" for 5 minutes.

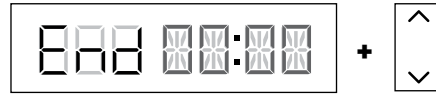

NOTE: If your food requires more time use the up arrows to the right of the display to add additional time. The unit will skip preheating.

Steam Bake

- 1 Place the reversible rack in the pot. Ensure there is liquid in the pot to create steam. Add a baking tin or foil on the bottom of the lower position of reversible rack.

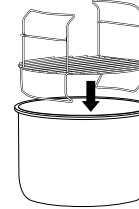

- 2 Move slider to COMBI-STEAM mode, then use the dial to select STEAM BAKE. The default temperature setting will display. Use the up and down arrows to the left of the display to choose a temperature in 5°C increments between 105°C and 210°C.

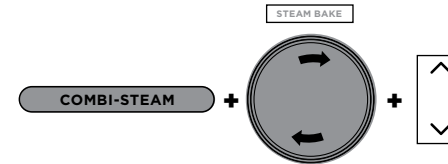

- 3 Use the up and down arrows to the right of the display to adjust the cook time in minute increments up to 1 hour 15 minutes.
- 4 Press START/STOP to begin cooking.
- 5 The display will show "PrE" and a progress bar indicating the unit is building steam. The time to steam is 20 minutes.



- 6 When preheating has completed, the display will show the set temperature and the timer will begin counting down.

- 7 When cook time reaches zero, the unit will beep and display "End" for 5 minutes.

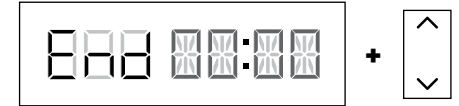

NOTE: If your food requires more time, use the up arrow to the right of the display to add additional time. The unit will skip preheating.

USING THE AIR FRY/HOB FUNCTIONS

To turn on the unit, plug the power cord into a wall socket, then press the  button.

NOTE: Opening the lid when using Air Fry, Bake or Grill will pause cook time. Close lid to resume.

Air Fry

- 1 Place either the Cook & Crisp™ Basket or reversible rack in the pot. Basket should have diffuser attached.

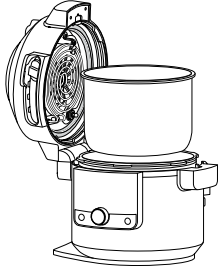
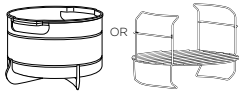

- 2 Add ingredients to the Cook & Crisp™ Basket or reversible rack. Close the lid.

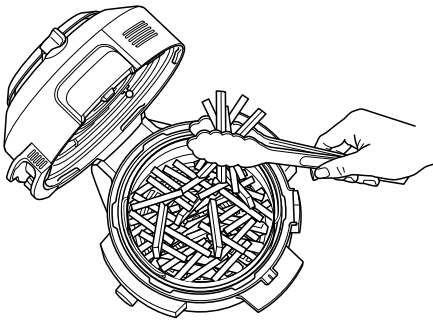

- 3 Move slider to AIR FRY/HOB, then use the dial to select AIR FRY. The default temperature setting will display. Use the up and down arrows to the left of the display to choose a temperature in 5°C increments between 150°C and 210°C.

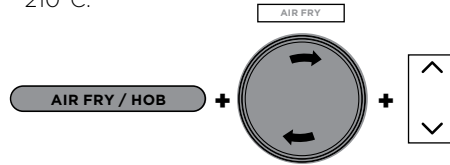

- 4 Use the up and down arrows to the right of the display to adjust the cook time in minute increments up to 1 hour.
- 5 Press START/STOP to begin cooking.
- 6 During cooking, you can open the lid and lift out the basket to shake or toss ingredients for even browning, if needed. When done, lower basket back into pot and close lid. Cooking will automatically resume after lid is closed.

NOTE: For best results, it is recommended to periodically shake ingredients during air frying. You can open the lid and lift out the basket to shake or toss ingredients for even browning. When done, lower the basket back into the pot and firmly close the lid. Cooking will automatically resume after the lid is closed.

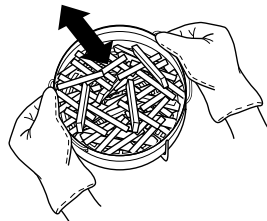

- 7 When cook time reaches zero, the unit will beep and "End" will flash 3 times on the display.

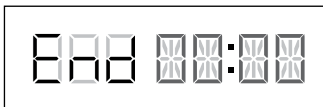

Grill

- 1 Place the reversible rack in the pot in the higher grill position or follow the directions in your recipe.

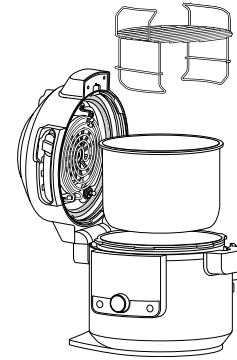

- 2 Place ingredients on the rack, then close the lid.

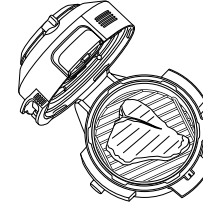

- 3 Move slider to AIR FRY/HOB, then use the dial to select GRILL.

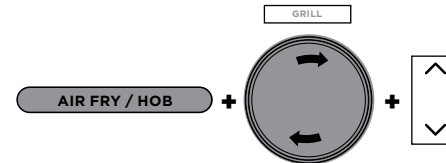

NOTE: There is no temperature adjustment available or necessary when using the Grill function.

- 4 Use the up and down arrows to the right of the display to adjust the cook time in minute increments up to 30 minutes.
- 5 Press START/STOP to begin cooking.
- 6 When cook time reaches zero, the unit will flash "End" will flash 3 times on the display.

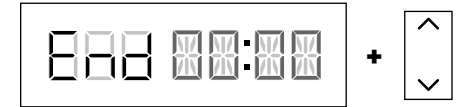

Bake

- 1 Place any accessories and ingredients in the pot. Close the lid.
- 2 Move slider to AIR FRY/HOB, then use the dial to select BAKE. The default temperature setting will display. Use the up and down arrows to the left of the display to choose a temperature in 5°C increments between 120°C and 210°C.

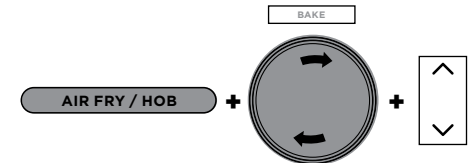

- 3 Use the up and down arrows to the right of the display to adjust the cook time in minute increments up to 1 hour and then 5-minute increments from 1 hour to 4 hours.
- 4 Press START/STOP to begin cooking.
- 5 When cook time reaches zero, the unit will beep and "End" will flash 3 times on the display.

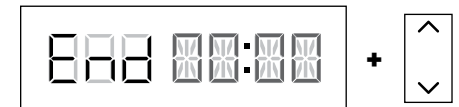

USING THE AIR FRY/HOB FUNCTIONS - CONT

Dehydrate

- Place the reversible rack in the pot in the lower position, then place a layer of ingredients on the rack.

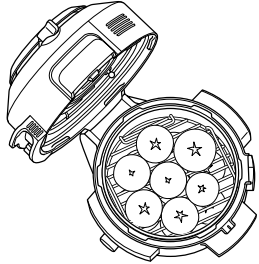

- Move slider to AIR FRY/HOB, then use the dial to select DEHYDRATE. The default temperature setting will display. Use the up and down arrows to the left of the display to choose a temperature in 5°C increments between 40°C and 90°C.

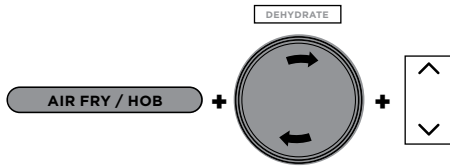

- Use the up and down arrows to the right of the display to adjust the cook time in 15-minute increments from 1 hour to 12 hours.
- Press START/STOP to begin cooking.
- When cook time reaches zero, the unit will beep and "End" will flash 3 times on the display.

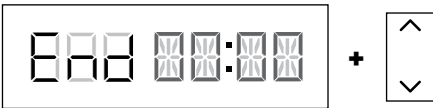

Sear/Sauté

- Add ingredients to the pot.
- Move slider to AIR FRY/HOB or open the lid, then use the dial to select SEAR/SAUTÉ. The default temperature setting will display. Use the up and down arrows to the left of the display to select "LO 1," "2," "3," "4," OR "Hi 5."

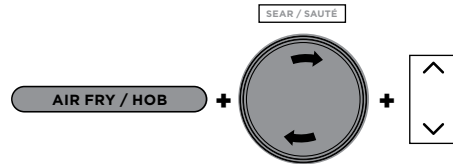

NOTE: There is no time adjustment available when using the Sear/Sauté function.

- Press START/STOP to begin cooking.
- Press START/STOP to turn off the SEAR/SAUTÉ function. To switch to a different cooking function, press START/STOP to end the cooking function then use the slider and dial to select your desired function.

NOTE: You can use this function with the lid open or with the lid closed.

NOTE: ALWAYS use non-stick utensils in the cooking pot. **DO NOT** use metal utensils, as they will scratch the non-stick coating on the pot.

NOTE: SEAR/SAUTÉ will automatically turn off after 1 hour for "4" and "Hi 5" and 4 hours for "Lo 1," "2" and "3."

Steam

- Add 250ml of liquid (or recipe-specified amount) to the pot, then place the reversible rack or Cook & Crisp™ Basket with ingredients in the pot.

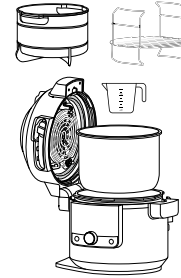

- Move slider to AIR FRY/HOB, then use the dial to select STEAM.

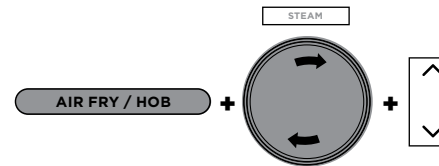

- Use the up and down arrows to the right of the display to adjust the cook time in 5 minute increments up to 30 minutes.
- Press START/STOP to begin cooking.

NOTE: There is no temperature adjustment when using the STEAM function.

- The unit will begin preheating to bring the liquid to a boil. The display will show "PrE". The preheating animation will show until the unit reaches temperature and then the display will show the timer counting down.



- When the cook time reaches zero, the unit will beep and "End" will flash 3 times on the display.

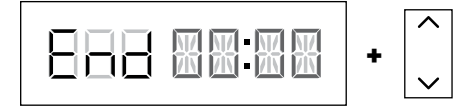

Slow Cook

- Add ingredients to the pot. **DO NOT** fill the pot past the MAX line.
- Move slider to AIR FRY/HOB, then use the dial to select SLOW COOK. The default temperature setting will display. Use the up and down arrows to the left of the display to select "Hi", "LO" or "bUFFEt."

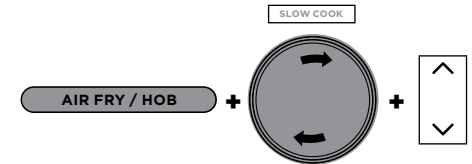

- Use the up and down arrows to the right of the display to adjust the cook time in 15-minute increments up to 12 hours.
- Press START/STOP to begin cooking.

NOTE: The Slow Cook bUFFEt time setting may be adjusted between 2 and 12 hours; the SLOW COOK HI time setting may be adjusted between 4 and 12 hours.

- When cook time reaches zero, the unit will beep, automatically switch to KEEP WARM and begin counting up.

NOTE: After cooking is complete, you may press KEEP WARM to turn the KEEP WARM mode off.

USING THE AIR FRY/HOB FUNCTIONS -CONT

Yogurt

- 1 Add desired amount of milk to the pot.

NOTE: If you prefer to pasteurise, cool and add cultures not using the unit, skip steps 1-9. Instead, press TEMP, select "FEr," press TIME, select desired incubation time, then press START/STOP to begin.

- 2 Close the lid.
- 3 Move slider to AIR FRY/HOB, then use the dial to select YOGURT. The default temperature setting will display. Use the up and down arrows to the left of the display to select "YGT" or "FEr."

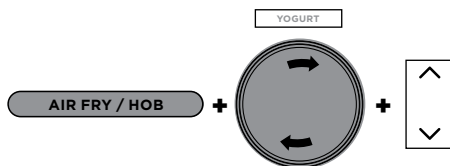

- 4 Use the up and down arrows to the right of the display to adjust the incubation time in 30-minute increments between 6 and 12 hours.

NOTE: Selecting a longer time will lead to tangier yogurt with a thicker consistency. Use 12 hours to achieve Greek-style yogurt.

- 5 Press START/STOP to begin pasteurisation..
- 6 Unit will display "boil" while pasteurising. When pasteurisation temperature is reached, the unit will beep and display "COOL".



- 7 Once the milk has cooled, the unit will display ADD and STIR in succession and the incubation time.

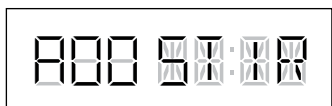

- 8 Open the lid and skim the top off the milk.
- 9 Add yogurt cultures to milk and stir to combine. Close the lid and press START/STOP to begin incubation process.
- 10 The display will show "FEr" and will begin counting down. When incubation time is complete, the unit will beep and END will flash 3 times on the display. The unit will beep each minute for up to 4 hours or until powered off.

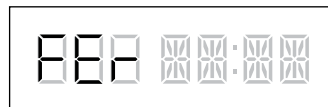

- 11 Chill yogurt for up to 12 hours before serving.

CLEANING & MAINTENANCE

Cleaning: Dishwasher & Hand-Washing

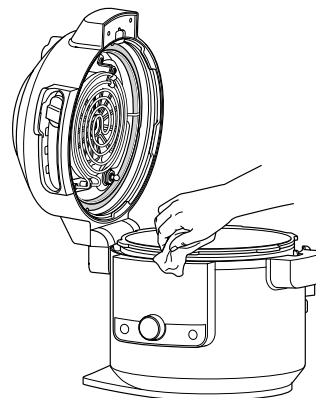

The unit should be cleaned thoroughly after every use.

- 1 Unplug the unit from the wall socket before cleaning.
- 2 To clean the cooker base and the control panel, wipe them clean with a damp cloth.
- 3 The cooking pot, silicone ring, reversible rack, Cook & Crisp™ Basket and detachable diffuser can be washed in the dishwasher.

NOTE: NEVER put the cooker base in the dishwasher or immerse it in water or any other liquid.

- 4 The pressure release valve and anti-clog cap, can be washed with water and dish soap.
- 5 If food residue is stuck on the cooking pot, reversible rack or Cook & Crisp™ Basket, fill the pot with water and allow to soak before cleaning. **DO NOT** use scouring pads. If scrubbing is necessary, use a non-abrasive cleanser or liquid dish soap with a nylon pad or brush.
- 6 Air-dry all parts after each use.

Removing & Reinstalling the Silicone Ring

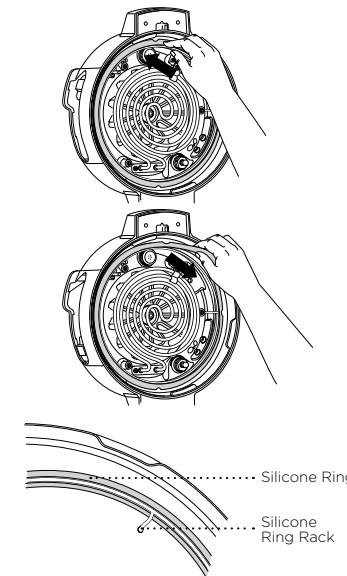

To remove the silicone ring, gently pull it outward, section by section, from the silicone ring rack. The ring can be installed with either side facing up. To reinstall, press it down into the rack section by section, (see image above).

After use, remove any food debris from the silicone ring and anti-clog cap.

Keep the silicone ring clean to avoid odour

Washing it in warm, soapy water or in the dishwasher can remove odour. However, it is normal for it to absorb the smell of certain acidic foods. It is recommended to have more than one silicone ring on hand. You can purchase additional silicone rings at ninjakitchen.sg / ninjakitchen.my.

NEVER pull out the silicone ring with excessive force, as that may deform it and the rack and affect the pressure-sealing function. A silicone ring with cracks, cuts or other damage should be replaced immediately.

NOTE: The silicone ring must be replaced by one that is specific to a Foodi® SmartLid Multi-cooker.

CLEANING THE LID

We recommend inspecting the interior of the lid prior to cooking with “wet cooking functions,” which include Slow Cook, Steam, Sear/Sauté, Pressure and all Combi-Steam mode functions. If you see any food residue or oil buildup, we recommend steam cleaning the unit (see instructions below), then wiping down the interior of the lid.

STEAM CLEANING INSTRUCTIONS:

- 1 Fill pot with 700ml of water.

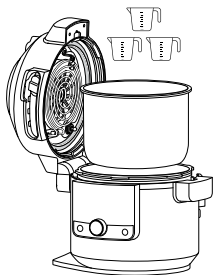

- 2 Move SmartLid Slider™ to Air Fry/Hob.

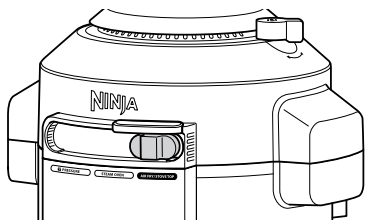

- 3 Select STEAM, and set time to 30 minutes. Press START/STOP.
- 4 When time reaches zero and the unit has cooled down, use a wet cloth or sponge to wipe down the interior of the lid. **CAUTION:** When cleaning the interior of the lid, do not touch the fan.

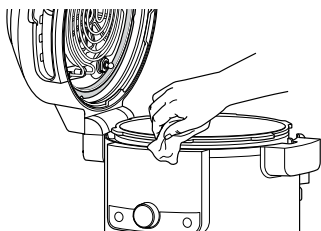

- 5 Repeat steps 3 and 4 as needed and spot clean as necessary.

NOTE: If the unit is not open after the cycle is over, the unit will default to KEEP WARM and the heating element will continue running.

TROUBLESHOOTING GUIDE

Why is my unit taking so long to come to pressure? How long does it take to come to pressure?

- Cooking times may vary based on the selected temperature, current temperature of the cooking pot and temperature or quantity of the ingredients.
- Check to make sure the silicone ring is fully seated and flush against the lid. If installed correctly, you should be able to tug lightly on the ring to rotate it.
- Check that the pressure lid is fully locked and the pressure release valve is in the SEAL position when pressure cooking.
- Unit will not pressurise if there is not enough liquid.

Why is the time counting down so slowly?

- You may have set hours rather than minutes. When setting time, the display will show HH:MM and the time will increase/decrease in minute increments.

How can I tell when the unit is pressurising?

- The display will show progress bar loading the building animation to indicate the unit is building pressure.

“PrE” and moving lights are shown on the display screen when using the Pressure or Steam function or any Combi-Steam mode Function.

- This indicates the unit is building pressure or preheating when using STEAM or PRESSURE. When the unit has finished building pressure, your set cook time will begin counting down.

There is a lot of steam coming from my unit when using the Steam function.

- It’s normal for steam to release through the pressure release valve during cooking.

Why can’t I open the lid after pressurising?

- As a safety feature, the lid will not unlock until the unit is completely depressurised. Turn the pressure release valve to the VENT position to quick release the pressurised steam. A quick burst of steam will spurt out of the pressure release valve. When the steam is completely released, the unit will be ready to open.

Is the pressure release valve supposed to be loose?

- Yes. The pressure release valve’s loose fit is intentional; it enables a quick and easy transition between SEAL and VENT and helps regulate pressure by releasing small amounts of steam during cooking to ensure great results. Please make sure it is turned as far as possible toward the SEAL position when pressure cooking and as far as possible toward the VENT position when quick releasing.

The unit is hissing and not reaching pressure.

- Make sure the pressure release valve is turned to the SEAL position. If you’ve done this and still hear a loud hissing noise, it may indicate the silicone ring is not fully in place. Press START/STOP to stop cooking, VENT as necessary and open the lid. Press down on the silicone ring, ensuring it is fully inserted and lies flat under the ring rack. Once fully installed, you should be able to tug lightly on the ring to rotate it.

The unit is counting up rather than down.

- The cooking cycle is complete and the unit is in KEEP WARM mode.

How long does the unit take to depressurise?

- The time it takes to release pressure depends on the quantity of food in the unit and can vary from recipe to recipe. Always ensure the float valve has dropped before trying to remove the lid. If the unit is taking longer than normal to depressurise, unplug the unit and wait until the float valve drops before opening the lid.

TROUBLESHOOTING GUIDE - CONT.

“ADD POT” error message appears on display screen.

- Cooking pot is not inside the cooker base. Cooking pot is required for all functions.

“SHUT LID” error message appears on display screen.

- The lid is open and needs to be closed for the selected function to start.

“ADD WATER” error message appears on display screen when using the Steam and Pressure function.

- The water level is too low. Add more water to the unit for the function to continue.

“PRESSURE FAIL” error message appears on display screen when using the Pressure function.

- Add more liquid to the cooking pot before restarting the pressure cook cycle.
- Make sure the pressure release valve is in the SEAL position.
- Make sure the silicone ring is installed correctly.

“ERR” message appears.

- The unit is not functioning properly. Please contact Customer Service at **SG** +65 800 120 5111 | **MY** +60 1800 803 915 EMAIL: customerservice@mann-noble.com

“SLIDE” error message appears on display screen.

- Move the slider to the position desired before selecting a cooking function.

“LOCK LID” error message appears on display screen.

- Move the slider to the PRESSURE position in order to lock the lid.

HELPFUL TIPS

- 1** For consistent browning, make sure ingredients are arranged in an even layer on the bottom of the cooking pot with no overlapping. If ingredients are overlapping, make sure to shake halfway through the set cook time.
- 2** For smaller ingredients that could fall through the reversible rack, we recommend first wrapping them in a parchment paper or foil pouch.
- 3** Use the KEEP WARM mode to keep food at a warm, food-safe temperature after cooking. To prevent food from drying out, we recommend keeping the lid closed and using this function just before serving.
- 4** To reheat food, use the AIR FRY function.

ONE (1) YEAR LIMITED REPLACEMENT WARRANTY

The warranty commences on the date of purchase and expires at the end of the 1 year period. In the unlikely event of a defect due to faulty materials or workmanship within the guarantee period we will replace the defective/faulty part with a new product, free of charge, or if the unit is deemed defective/faulty we replace the unit with an equivalent or upgraded model, at our discretion.

For warranty claims, you will need to submit a proof of purchase in the form of a valid receipt that displays date and place of purchase.

Replacement items will be covered by the limited warranty for the balance of the warranty period from the date of the original purchase. Please note:

Your warranty is subject to the following conditions

- **DO NOT** operate the appliance with a damaged plug or cord, or if the unit has been dropped, damaged or dropped in water.
- To avoid the risk of electric shock, do not disassemble or attempt to repair the appliance on your own. If the supply cord is damaged, it must be replaced by a qualified electrician to avoid a hazard. Incorrect re-assembly or repair can cause a risk of electric shock or injury to persons when the appliance is used.
- The item has not been misused, abused, neglected, altered, modified or repaired by anyone.
- The item has been subjected to fair wear and tear.
- The item has not been used for trade, professional or hire purposes.
- The item has not sustained damage through foreign objects, substances or accident

Accidental damage

Damage as a result of use not in accordance with the rating plate

Use of parts and accessories that are not genuine Ninja components

Customer costs within warranty

The customer is responsible for any inwards freight charge to return a product for warranty if requested, and outward freight charge for warranty parts and or replacement unit.

Who is covered?

This warranty applies only to the original purchaser, who bought the product from an authorised retailer and may not be transferred. Proof of purchase is required.

What is not covered?

Accessories supplied with the item.

Components that are subject to natural wear and tear caused by normal use in accordance with operating instructions.

Unauthorised/improper maintenance/handling or overload is excluded from this warranty.