

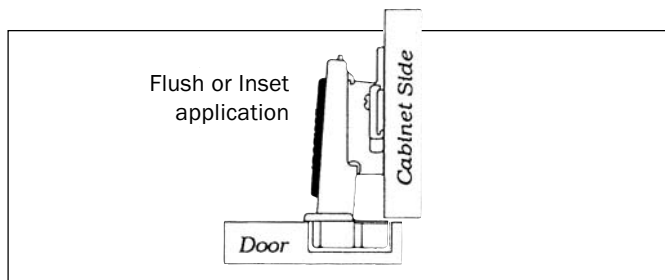

Blum European CLIP Top Hinges With Standard Plate

Product #131236

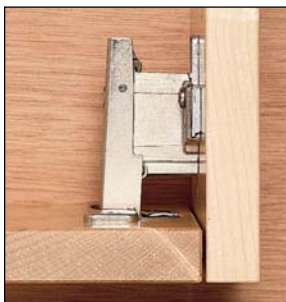

Note: Maximum door thickness 1 1/32".

Hinge Mounting Instructions

- A.** Decide on the number of hinges you want to use and mark their centerline locations on the back of the door (see Figure 1).
- B.** Transfer the centerline to the inside of the cabinet.
- C.** Using a 35mm (1 3/8") forstner bit bore the mounting hole for the hinge cup in the back of the door to a depth of 1/2". NOTE: Depending on the required reveal (the amount of cabinet edge you wish to leave exposed when the door is closed or the space between the door and cabinet side for inset applications) adjust the *drilling distance "B"* from 1/16" to 1/4" off the edge of the door. To insure the proper operation of the installation we suggest that you make a sample and test the fit before actually boring the finished stock.
- D.** Locate the screw hole centerlines for the mounting clip 37mm from the front edge of the cabinet. **When using inset hinges, the mounting plate must be set back from the 37mm location by a distance equal to the thickness of the door.** Align the center of the mounting plate with the hinge centerline previously marked on the inside of the cabinet and install screws.
- E.** With the hinges in the open position simply "clip" the arm to the mounting plate and follow the diagram for "three-way" adjustment!

Number of Hinges per Door

There is no general rule. Obviously this depends on the size and weight of the door. We can give you a rough guide for the more standard applications. In special cases (a door with a mirror) we suggest you conduct a trial for yourself.

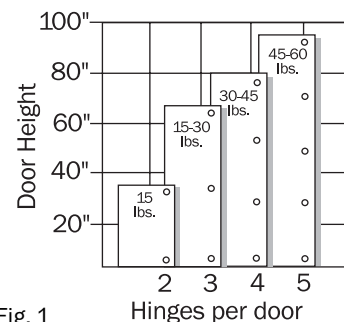
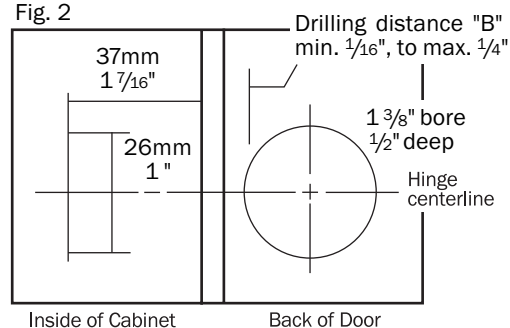
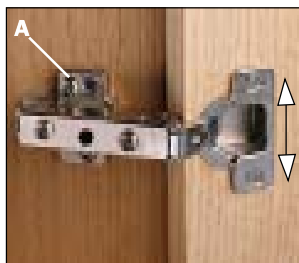

Fig. 1

Fig. 2



A Great Advantage: Three dimensional independent adjustments.



Height adjustment 4mm (5/32"): Loosen screw A, to adjust door to desired position, re-tighten screw.

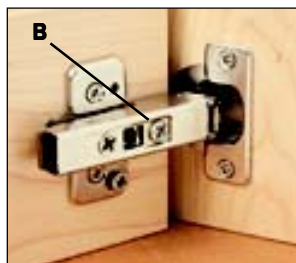

Door side adjustment 4mm (5/32"): Turn cam action screw B, to adjust door to desired position.

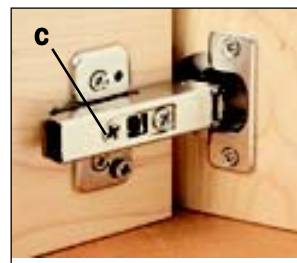

Door depth adjustment 5mm (5/32"): Turn cam action screw C, to adjust door to desired position.

Note: Cam Action means that the door is adjusted by simply turning the adjustment screw,