

# ***SPRAYTT***

## **Airless Spray Gun**

# **Operating Instruction**

**Model: SP2022**

---

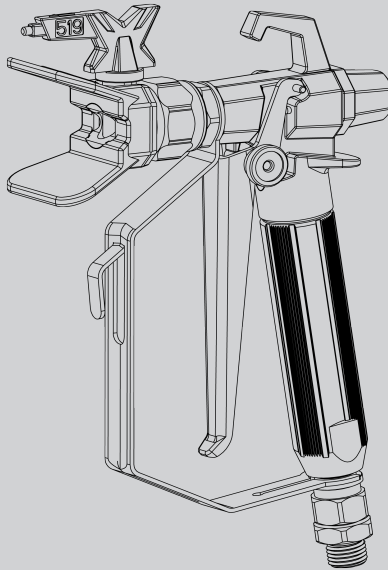

Please read and keep this manual, Read carefully before attempting to assemble, install, operate or maintain the product described. Protect yourself and others by observing all safety information. Failure to comply with instructions could result in personal injury and/or property damage! Retain instruction for future reference.

---

# Safety Precautions



**SAFETY ALERT: All local and national regulations governing ventilation, fire prevention, and operation must be observed.**



## **HAZARD: Injection injury**

**A high pressure stream produced by this equipment can pierce the skin and underlying tissues, leading to serious injury and possible amputation. See a physician immediately.**

**DO NOT TREAT AN INJECTION INJURY AS A SIMPLE CUT! Injection can lead to amputation. See a physician immediately. Inform the physician of the type of coating material or cleaning agent with which the injury was caused.**

**The maximum operating range of the spray gun is 25 MPa / 3600 PSI fluid pressure.**

- NEVER aim the gun at any part of the body.
- NEVER allow any part of the body to touch the fluid stream. DO NOT allow body to touch a leak in the fluid hose.
- NEVER put hand in front of the gun. Gloves will not provide protection against an injection injury.
- Never point the spray gun at anyone else.
- ALWAYS lock the gun trigger, shut the pump off, and release all pressure before servicing, cleaning the tip or guard, changing tip, or leaving unattended. Pressure will not be released by turning off the motor. The PRIME/SPRAY valve must be turned to PRIME to relieve the pressure. Refer to the Pressure Relief Pressure described in the pump manual.
- ALWAYS keep the tip guard in place while spraying. The tip guard provides some protection but is mainly a warning device.
- ALWAYS remove the spray tip before flushing or cleaning the system.
- The paint hose can develop leaks from wear, kinking and abuse. A leak can inject material into the skin. Inspect the hose before each use.
- NEVER use a spray gun without a trigger lock and trigger guard in place and in good working order.
- All accessories must be rated at or above the maximum operating pressure range of the airless sprayer. This includes spray tips, extensions, and hose.



**HAZARD: Explosion hazard due to incompatible materials  
Will cause severe injury or property damage.**

- Do not use materials containing bleach or chlorine.
- Do not use halogenated hydrocarbon solvents such as bleach, mildewcide, methylene chloride and 1,1,1 - trichloroethane. They are not compatible with aluminum.
- Contact your coating material supplier about the compatibility of material with aluminum.



**HAZARD: General  
This product can cause severe injury or property damage.**

1. Read all instructions and safety precautions before operating equipment.
  2. Never spray near sources of ignition; e.g. open flames, cigarettes — also cigars and pipes are sources of ignition —, sparks, hot wires and hot surfaces, etc.
  3. Wear respiratory equipment when spraying. The operator must be provided with a protective mask.  
In order to prevent work related illness, the manufacturer's regulations for the materials, solvents, and cleaning agents used must be observed when preparing, working with and cleaning the unit. Protective clothing, gloves, eyewear, and, in certain cases, protective skin cream are necessary to protect the skin.
  4. Follow the coating material and solvent manufacturer's warnings and instructions.
  5. Extraction equipment should be installed by the user in accordance with local regulations.
  6. The objects being sprayed must be earthed.
  7. Before each use, check all hoses for cuts, leaks, abrasion or bulging of cover. Check for damage or movement of couplings. Immediately replace the hose if any of these
-

conditions exist. Never repair a paint hose. Replace it with another grounded high-pressure hose.

8. Pulling the trigger causes a recoil force to the hand that is holding the spray gun.  
The recoil force of the spray gun is particularly powerful when the tip has been removed and a high pressure has been set on the airless high-pressure pump. Therefore, when cleaning without tip set the pressure control valve to the lowest pressure.
9. Use only manufacturer authorized parts. User assumes all risks and liabilities when using parts that do not meet the minimum specifications and safety devices of the spray gun manufacturer.



## EXPLOSION PROTECTION IDENTIFICATION

### X marking:

The spray gun corresponds with Ex II 2G X and is, in accordance with Directive 94/9/EEC (Atex 100a), suitable for use in explosion-hazardous areas—as of type Zone 1. Under certain circumstances, the unit itself may cause the Zone 1 condition to be in effect.

**Any static-electricity discharge from the spray gun is to be diverted to the grounded high-pressure pump via the conductive high-pressure hose as stipulated.**

**The maximum surface temperature corresponds to the permissible material temperature. This and the permissible ambient temperature can be found in the Technical Data.**

To avoid the generation of machine sparks, prevent impact stresses and any work on the unit with tools in the explosion-hazardous area.

## Residual risks

Residual risks are risks, which cannot be excluded, even when equipment is used for the intended purpose.

In such cases the applicable areas of the actual residual risks will be pointed out using warning and/or prohibition signs.

Risk	Source / Cause	Impact	Preventative measures	Can occur during:
Injection injury	Atomized, high pressure stream of fluid	Severe injury or amputation	NEVER aim the gun at any part of the body	Setup, Operation
Explosion or fire	Static electricity or sparks	Severe injury	Use well ventilated area Ground the spray gun	Operation
Hazardous vapors	Hazardous vapors from spray material	Severe injury	Use well ventilated area Use mask	Operation

## Technical Data

Max. operating pressure	25 MPa (3600 PSI)	
Material inlet thread size	NPSM 1/4" - PT 1/4-(M16 x1.5)	
Diffuser thread size	7/8 -	11/16 -
Wetted parts material	High-grade stainless steel, aluminum, PTFE, hard metal	
Operating temperature range	5°C to 40°C (40°F to 104°F)	
Maximum material temperature	43°C (109°F)	
Weight	460 g (16.3 oz)	

# Introduction

This airless spray gun is to be used for the high pressure atomization of liquid coating materials.

## Using the Gun Trigger Lock

Always engage the gun's trigger lock when the gun is not in use.

1. To lock the trigger, rotate the trigger lock anticlockwise until it stops (Left side).
2. To unlock the trigger, rotate the trigger lock to the middle position.

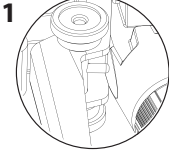

Gun locked  
(gun will not spray)

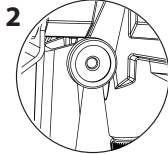

Gun unlocked  
(gun will spray)

3. To lock the trigger on spray mode, rotate clockwise forward until it stops (Left side).

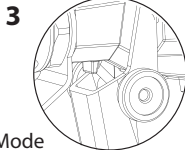

Spray Mode  
(gun will spray continuously)

## Setup



**Never attempt to assemble, change, or clean the gun, tip, or tip guard without first relieving pressure from the spray system. Follow the "Pressure Relief Procedure" in the sprayer's Owner's Manual.**



**Always use a tip safety guard for added protection against injection. Beware that the guard alone will not prevent injection. Never cut off tip guard! Always engage gun trigger lock when the gun is not in use. Before servicing equipment, consult Owner's Manuals and follow all warnings.**

1. Set up the sprayer. Refer to the instructions in the sprayer's Owner's Manual.
2. Attach a grounded, airless spray hose to the material inlet on the gun. Using two wrenches (one on the gun and one on the hose), tighten securely.
3. With the tip and tip guard off the gun, start the sprayer. Flush and prepare the spray system according to the sprayer's Owner's Manual. Inspect the spray system to make sure that all fittings are secure and that there are no leaks.

4. Perform the "Pressure Relief Procedure" described in the sprayer's Owner's Manual.
5. Using the tip, insert the tip seal into the tip guard. Press in for final adjustment.
6. Insert the tip into the slot on the tip guard. Push and rotate tip clockwise. Lock tip into place.

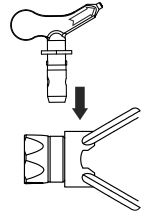
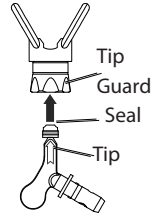

7. Thread the tip guard onto the gun. Position the tip guard in the desired spraying position, then tighten securely.



**The arrow on the tip handle should be pointing in the forward direction for spraying.**

## Operation

1. Make sure the arrow on the tip handle is pointing in the forward direction for spraying.
2. Start the sprayer. Refer to the instructions in the sprayer's Owner's Manual.
3. Adjust the fluid pressure on the sprayer until the spray is completely atomized. Always spray at the lowest pressure necessary to get the desired results.



**The spray tip determines the size of spray pattern and coverage. When more coverage is needed, use a larger tip instead of increasing fluid pressure.**

Unscrew the tip guard before reversing the tip for cleaning will prolong the lifetime of the tip seal

4. To clear a clogged tip:
  - a. Rotate the tip 180° so that the arrow on the tip handle is pointing opposite the spray direction.
  - b. Trigger the gun once so that the pressure can blow the clog out.



Attention

**Never pull the trigger more than once at time with the tip in the reverse position.**

- c. Continue this procedure until the tip is clear of the clog.

## Changing a Tip

Tips can be removed and replaced easily without disassembling the gun.



**Never attempt to change or clean the tip or tip guard without first performing the "Pressure Relief Procedure."**

1. Perform the "Pressure Relief Procedure" described in the sprayer's Owner's Manual.
2. Remove the tip from the slot on the tip guard.
3. Insert the new tip into the slot on the tip guard. Push and rotate clockwise. Lock tip in place. The arrow on the tip handle should be pointing in the forward direction for spraying.

## Remove and Replace the Seal and Tip

1. Remove the tip and tip guard from the spray gun.
2. Remove the seal and tip seal from the back of the tip guard.

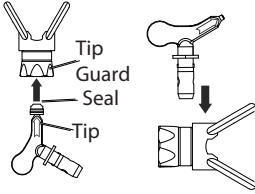

Insert tip into guard.  
Push and rotate tip clockwise.  
Lock tip in place

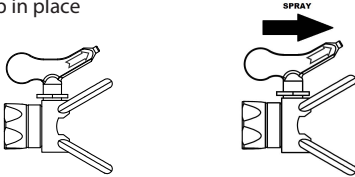

## Identifying Tip Sizes

To identify tip sizes, use the following formula. A "517" tip size will be used in this example. The first digit multiplied by two represents the size of the spray pattern when spraying 12" away from the work surface:

$$5 \times 2 = 10'' \text{ spray pattern}$$

The second two digits represent the diameter of the orifice on the tip:

$$17 = .017'' \text{ orifice}$$



**Worn spray tips will adversely affect the spray pattern and result in reduced production, poor finish, and wasted material. Replace worn tips immediately.**

## Cleanup

Maintaining a clean gun is important to ensure trouble-free operation. Flush the gun after each use and store in a dry location. Do not leave the gun or any of its parts in water or solvents.



**Special cleanup instructions for use with flammable solvents:**

- Always flush spray gun preferably outside and at least one hose length from spray pump.
- If collecting flushed solvents in a one gallon metal container, place it into an empty five gallon container, then flush solvents.
- Area must be free of flammable vapors.
- Follow all cleanup instructions.



**The sprayer, hose, and gun should be cleaned thoroughly after daily use. Failure to do so permits material to cake, seriously affecting the performance of the unit.**



**Always spray at minimum pressure with the tip and tip guard removed when using mineral spirits or any other solvent to clean the sprayer, hose, or gun. Static electricity buildup may result in a fire or explosion in the presence of flammable vapors. Hold the gun firmly against a metal container while flushing.**

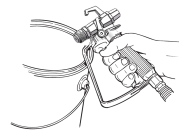
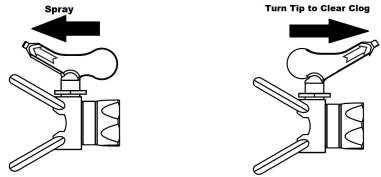

Spray Gun Filter

Attach Hose to Spray Gun

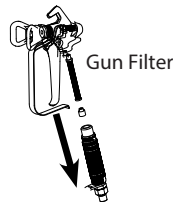

Gun Filter

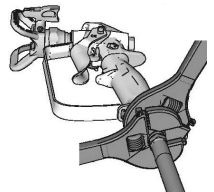

## Maintenance

Follow all safety precautions as described in the Safety Precautions section of this manual before proceeding.



Refer to the Parts List section in this manual for part identification.

### Replacing/Serviceing the Seal Assembly

If your spray gun leaks or spits at the tip when you release the trigger, the needle or seat is worn, damaged, or dirty and must be replaced or cleaned.



**Never attempt to perform maintenance on the spray gun without first performing the "Pressure Relief Procedure."**

1. Disconnect the fluid hose from the gun.
2. Remove the tip and tip guard.
3. With the trigger depressed, remove the diffuser from the front of the gun.
4. Remove the lock nut, rear housing, and retractor pins from the rear of the gun head.
5. Remove the seal assembly from the front of the gun head by pushing or gently tapping at the back of the seal assembly.
6. Soak the removed parts in the appropriate solvent and wipe clean.
7. Inspect the parts for wear or damage and use new parts during reassembly of the gun, when necessary.



**Lubricate all packings and moving parts before reassembly with a lithium-based grease.**

8. Install the seal assembly into the front of the gun head.
7. Insert the packing seal assembly into the rear of the gun head and thread it by hand until it stops.
8. Using a 3/8" socket, tighten the packing seal assembly. Torque to 5 Nm (3.7 ft./lbs.).
9. Install the retractor pins into the rear of the gun head. Slide the rear housing onto the retractor pins and secure in position with the lock nut.
10. With the trigger depressed, install the diffuser into the front of the gun head and tighten securely with a wrench.
11. Perform the "Adjusting the Seal Assembly" procedure described below.

## Adjusting the Packing Seal Assembly



**Proper adjustment of the packing seal assembly is essential to ensure positive shut-off when the trigger is released.**

1. Tighten the lock nut until the rear housing is flush against the gun head.
2. Unscrew the lock nut 3/4 of a turn.



**To check the adjustment of the seal assembly:**

1. Move the gun trigger lock to the locked position.
2. Pull the trigger. With the trigger lock engaged, there should be 1/32" of movement between the lock nut and the rear housing while pulling the trigger.

### Replacing/Removing the Filter

1. Pull the bottom of the trigger guard forward so that it comes loose from the handle assembly.
2. Loosen and remove the handle assembly from the gun head.
3. Pull the old filter out of the gun head.
4. Slide the new filter, tapered end first, into the gun head.
5. Place the handle seal into the gun head with the flat side of the seal toward the gun head.

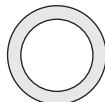

Flat side of handle seal (toward gun head)



Bevelled side of handle seal (toward handle)

6. Thread the handle assembly into the gun head until secure.
7. Snap the trigger guard back onto the handle assembly.

### Filter Chart

Part Number	Application	Filter Type	Filter Color
637F150	Synthetic resin, enamels, clean varnishes, stains, azures	Extra fine	Red
637F100	Base coat enamels, primer enamels, fillers, marking paints, textured enamels	Fine	Yellow
637F60	Emulsions, latex paints, acrylic paints	Medium	White
637F30	Filler paints, large area surfaces	Coarse	Green

## AIRLESS SPRAYING MATERIAL -TIP SIZE CHART

Spraying Material	From		To	Viscosity
Varnishes	0.009	-	0.011	<b>Thin materials</b>
Lacquers, clear coat	0.009	-	0.011	
Shellac (clear)	0.009	-	0.013	
Stains - transparent	0.011	-	0.013	
Water sealers (thin, clear)	0.011	-	0.013	
Tung Oil (pure thinned)	0.011	-	0.013	
Oil based paints	0.013	-	0.015	<b>Medium</b>
Lacquers, water borne	0.013	-	0.015	
Acrylics, clear	0.013	-	0.015	
Acrylics 100%, latex int	0.013	-	0.015	
Varnishes (low VOC)	0.013	-	0.015	
Polyurethanes	0.013	-	0.015	
Stains - solid	0.013	-	0.015	
Enamels - oil-base	0.013	-	0.015	
Latex paint - interior	0.015	-	0.017	
Latex paint - exterior	0.017	-	0.019	
Primers - latex	0.015	-	0.017	
Primers - oil	0.017	-	0.019	
Sealers	0.017	-	0.021	
Membrane	0.017	-	0.021	
Epoxy	0.017	-	0.021	
Heavy Latex	0.021	-	0.025	<b>Thicker</b>
Elastomerics (smooth)	0.021	-	0.025	
Epoxy (heavy)	0.023	-	0.027	
Membrane (heavy)	0.023	-	0.027	
Elastomerics	0.025	-	0.039	<b>Thick materials</b>
Block Fillers	0.025	-	0.039	
Membrane (very heavy)	0.029	-	0.039	
Epoxy (high solids)	0.029	-	0.039	
Solventless	0.029	-	0.039	

# Parts list

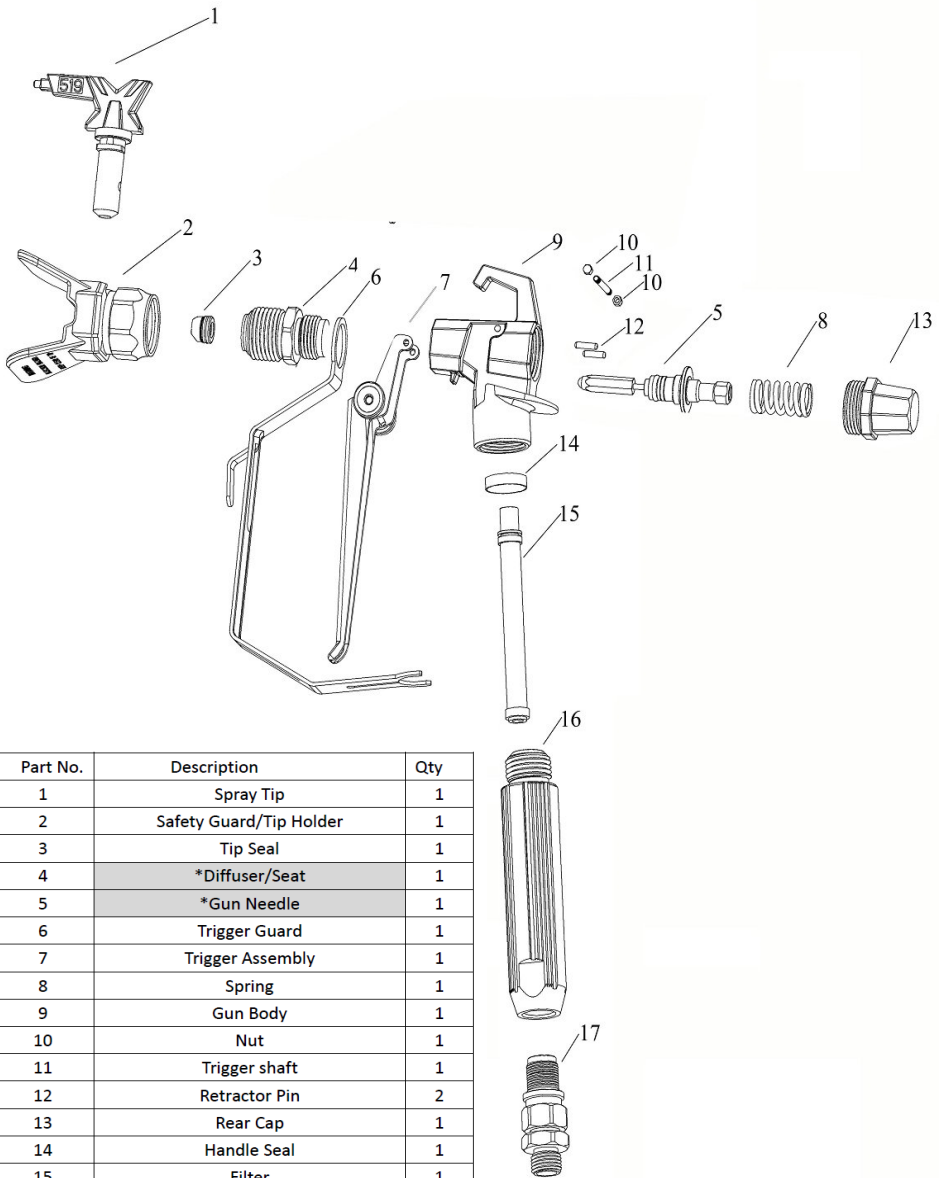

Part No.	Description	Qty
1	Spray Tip	1
2	Safety Guard/Tip Holder	1
3	Tip Seal	1
4	*Diffuser/Seat	1
5	*Gun Needle	1
6	Trigger Guard	1
7	Trigger Assembly	1
8	Spring	1
9	Gun Body	1
10	Nut	1
11	Trigger shaft	1
12	Retractor Pin	2
13	Rear Cap	1
14	Handle Seal	1
15	Filter	1
16	Handle	1
17	Inlet connector	1

Parts with \* are the standard gun repair kits



# SPRAYIT Limited Warranty

This warranty is limited to Airless Paint Equipment distributed by:

SPRAYIT  
8560 Siempre Viva Road  
San Diego, CA 92154

## Limited Warranty

SPRAYIT will repair or replace, free of charge, to the original retail customer who purchased a SPRAYIT product from an authorized dealer, distributor or distributor's dealer in North America.

This warranty does not transfer to subsequent owners.

SPRAYIT will repair or replace, at its option, any parts that are proven by an authorized service center to be defective in material or workmanship under normal use during the applicable warranty time period as stated below. This limited warranty covers the cost of the replacement parts and labor for all defects when installed by an authorized service center.

Transportation charges are the responsibility of the customer. Any part replaced under warranty becomes the property of SPRAYIT.

All parts replaced under warranty will be considered as part of original product, and any warranty on those parts will expire coincident with the original product warranty.

## Limited Warranty Periods

Non-commercial / Non-rental (personal use by a retail customer): **1 year parts and labor**

Commercial / Rental (usage for income, business use): **1 year parts and labor**

**The limited warranty period begins on the date of retail purchase by the original purchaser.  
The original receipt or invoice is required for warranty.**

## Disclaimers, Limitations of Remedies & Exclusions

This warranty gives you specific legal rights, and you may also have other rights which may vary from state to state.

## Disclaimer of Other Warranties

To the fullest extent permitted by applicable law, this limited warranty is exclusive and expressly in lieu of any and all other warranties, including, without limitation, any implied warranties of merchantability or fitness for a particular purpose or any other implied warranties that may arise from the course of dealing or usage of the trade. SPRAYIT hereby disclaims and excludes all other warranties. To the extent that SPRAYIT products are consumer products under applicable federal and state law with respect to any customer, the duration of any implied warranties (including but not limited to implied warranties of merchantability or fitness for a particular purpose) are limited to the shortest duration permitted by applicable law or the Limited Warranty period provided herein, whichever is longer.

## Limitations of Remedies

SPRAYIT shall not be liable to customer, or anyone claiming under customer, for any other obligations or liabilities, including but not limited to, obligations or liabilities arising out of breach of contract or warranty, negligence or other tort or any theory of strict liability, with respect to the paint sprayer or SPRAYIT acts or omissions or otherwise. To the fullest extent permitted by applicable law, SPRAYIT shall not in any event be liable for incidental, compensatory, punitive, consequential, indirect, special or other damages, including but not limited to loss of use, loss of income, loss of time, loss of sales, injury to personal property, or liability customer incurs with respect to any other person, or any person, or any other type or form of consequential damage or economic loss.

## **Exclusions**

In addition to the foregoing disclaimers, limitations and terms, this limited warranty shall not apply to and does not cover accessories, nor does it cover products that are in any way subject to any of the following:

1. Improper setup, installation or storage.
2. Lack of proper maintenance and service.
3. Accident, damage, abuse or misuse.
4. Abnormal operating conditions or applications.
5. Repair or modification by customer or any third party without written consent of SPRAYIT.
6. Use under operating conditions or in applications not recommended by SPRAYIT.
7. Abnormal wear.
8. The use of accessories or attachments not recommended by SPRAYIT
9. Acts of God.

The application of these exclusions will be determined at the sole discretion of SPRAYIT.

## **Maintenance & Troubleshooting Guide**

**SPRAYIT provides Maintenance & Troubleshooting Guide on our website**

**[WWW.CALIFORNIAAIRTOOLS.COM](http://WWW.CALIFORNIAAIRTOOLS.COM).**

**Valuable information regarding set-up, operation and maintenance.  
Please visit our website and view these videos for beneficial information.**

## **Service or Parts**

**Warranty is also available by keeping and showing your original receipt from the date of purchase to an Authorized Service Center.**

**For all customer service inquiries call 1-866-409-4581 or visit**

**[WWW.CALIFORNIAAIRTOOLS.COM](http://WWW.CALIFORNIAAIRTOOLS.COM)**

**Go to the “Contact Us” Tab**

**Click on “Service & Parts” Buttons for the Fastest Service.**