

FESTOOL

OF 1400 EQ



Plunge Router Instruction Manual

Important: Read and understand all instructions before using this tool.

Warranty

Conditions of 1+2 Warranty

You are entitled to a free extended warranty (1 year + 2 years = 3 years) for your Festool power tool. Festool shall be responsible for all shipping costs during the first year of the warranty. During the second and third year of the warranty

the customer is responsible for shipping the tool to Festool. Festool will pay for return shipping to the customer using UPS Ground Service. All warranty service is valid 3 years from the date of purchase on your receipt or invoice.

Festool Limited Warranty

This warranty is valid on the pre-condition that the tool is used and operated in compliance with the Festool operating instructions. Festool warrants, only to the original consumer purchaser, that the specified tool will be free from defects in materials and workmanship for a term of one year from the date of procurement. Festool makes no other warranty, express or implied, for Festool portable power tools. No agent, representative, distributor, dealer or employee of Festool has the authority to increase or otherwise change the obligations or limitations of this warranty. The obligations of Festool in its sole discretion under this warranty shall be limited to the repair or replacement of any Festool portable power tool that is found to be defective as packaged with the User Manual.

Excluded from coverage under this warranty are: normal wear and tear; damages caused by misuse, abuse or neglect; damage caused by anything other than defects in material and workmanship. This warranty does not apply to accessory items such as circular saw blades, drill bits, router bits, jigsaw blades, sanding belts, and grinding wheels. Also excluded are "wearing parts", such as carbon brushes, lamellas of air tools, rubber collars and seals, sanding discs and pads, and batteries.

Festool portable power tools requiring replacement or repair are to be returned with the receipt of purchase to Festool (call 800-554-8741 for address details).

IN NO EVENT SHALL FESTOOL BE LIABLE FOR ANY CONSEQUENTIAL OR INCIDENTAL DAMAGES FOR BREACH OF THIS OR ANY OTHER WARRANTY, EXPRESSED OR IMPLIED WHATSOEVER. ALL WARRANTIES IMPLIED BY STATE LAW, INCLUDING THE IMPLIED WARRANTIES OF MERCHANTABILITY AND FITNESS FOR A PARTICULAR PURPOSE, ARE HEREBY LIMITED TO THE DURATION OF THREE YEARS.

Some states in the U.S. and some Canadian provinces do not allow the limitations on how long an implied warranty lasts, so the above limitation may not apply to you. With the exception of any warranties implied by state or province law as hereby limited, the foregoing express limited warranty is exclusive and in lieu of all other warranties, guarantees, agreements and similar obligations of Festool. This warranty gives you specific legal rights and you may also have other rights which vary from state to state in the U.S., and province to province in Canada.

As hereby limited, the foregoing express limited warranty is exclusive and in lieu of all other warranties, guarantees, agreements and similar obligations of Festool. This warranty gives you specific legal rights and you may also have other rights which vary from state to state in the U.S. and province to province in Canada.

Liability Statement

This product has been built to the high standards of Festool. Please do not attempt to operate or repair this equipment without adequate training. Any use, operation, or repair in contravention of this document is at your own risk. By acceptance of this system you hereby assume all liability

consequent to your use or misuse of this equipment. Festool assumes no liability for incidental, special, or consequential damage of any kind. Equipment specifications, applications, and options are subject to change at the sole discretion of Festool without notice.

Proprietary Notice

All drawings and information herein are the property of Festool, TTS Tooltechnic Systems AG & Co. KG. All unauthorized use and reproduction is prohibited.

Written and Illustrated by Rick Christopherson.

© 2005 TTS Tooltechnic Systems AG & Co. KG

All rights reserved. Printed in the United States of America and Germany.

Festool is a trademark and service mark of TTS Tooltechnic Systems AG & Co. KG

www.festoolusa.com

Contents

Warranty	2	Basic Routing.....	12
Conditions of 1+2 Warranty	2	Fixed Depth.....	12
Festool Limited Warranty	2	Feed Direction Rules.....	12
Liability Statement	2	Plunge Routing.....	13
Proprietary Notice.....	2	Plough Cuts.....	13
General Safety Rules.....	4	Router Speed and Feed Rate.....	13
Work Area Safety	4	Advanced Routing Techniques	14
Electrical Safety	4	Starting a Cut Near a Corner	14
Extension Cords	4	Multi-pass Cuts.....	15
Personal Safety	4	Multi-depth Ploughing.....	15
Tool Use and Care.....	4	Multi-depth Profiles.....	15
Service.....	5	Multi-position (horizontal) Profiles.....	15
Specific Safety Rules for Routers.....	5	Pre-cutting Dovetails and Keyways.....	16
Router Feed Direction.....	5	Tips for Successful Routing	16
Respiratory Exposure Warning.....	5	Chipping and Tearout	16
Tool Description.....	6	Chatter	16
Power Controls	7	Climb-cutting with Small Diameter Bits	17
Technical Specifications.....	7	Accessories.....	18
Changing Router Bits.....	8	Guide Rail Attachment.....	18
Changing Collets.....	8	Assembling the Guide Rail Attachment	18
Dust Collection.....	9	Using the Guide Rail Attachment.....	19
Dust Extraction Hood.....	9	Alternative Method for Using the Guide Rail	
Chip Diverter	9	Attachment	20
Setting the Plunge Depth.....	10	Edge Guide.....	21
Using the Plunge Depth Gauge	10	Template Guides	22
Using the Depth Stop Turret.....	11	Systainer (System Container)	23
Calibrating the Turret Posts.....	11	Troubleshooting.....	24
Using the Turret for Successive Depths.....	11	Maintenance	25
Using the Turret for Precision Depths	12	Routine Maintenance.....	25
		Changing the Motor Brushes.....	26

General Safety Rules

WARNING: Read and understand all instructions listed below. Failure to heed instructions may result in personal injury, electrocution, or fire hazard.

Save These Instructions

Work Area Safety

- ▶ **Keep your work area clean and well lit.** Cluttered benches and dark areas invite accidents.
- ▶ **Do not operate power tools in explosive atmospheres, such as in the presence of flammable liquids, gases, or dust.** Power tools create sparks which may ignite the dust or fumes.
- ▶ **Keep bystanders, children, and visitors away while operating a power tool.** Distractions can cause you to lose control.

Electrical Safety

- ▶ **Double insulated tools are equipped with a polarized plug (one blade is wider than the other).** This plug will fit in a polarized outlet only one way. If the plug does not fit fully in the outlet, reverse the plug. If it still does not fit, contact a qualified electrician to install a polarized outlet. Do not change the plug in any way. Double insulation eliminates the need for the three wire grounded power cord and grounded power supply system.
- ▶ **Avoid body contact with grounded surfaces such as pipes, radiators, ranges and refrigerators.** There is an increased risk of electric shock if your body is grounded.
- ▶ **Do not expose power tools to rain or wet conditions.** Water entering a power tool will increase the risk of electric shock.
- ▶ **Do not abuse the cord.** Never use the cord to carry the tools or pull the plug from an outlet. Keep cord away from heat, oil, sharp edges or moving parts. Replace damaged cords immediately. Damaged cords increase the risk of electric shock.

Extension Cords

All due care should be practiced while using extension cords with this tool.

- ▶ **When operating a power tool outside, use an outdoor extension cord marked "W-A" or "W".** These cords are rated for outdoor use and reduce the risk of electric shock.
- ▶ **Never use an extension cord that is damaged, such as cuts, exposed wires, or bent/missing prongs.**
- ▶ **Use only extension cords rated for the purpose.**
- ▶ **Use only extension cords rated for the amperage of this tool and the length of the cord.** Using too small of an extension cord can cause the router to lose power and damage the tool.

Extension Cord Ratings	
Cord Length	Size (AWG)
<50 Ft.	14
50-100 Ft.	12
100-150 Ft.	10
>150 Ft.	Not recommended

Personal Safety

- ▶ **Stay alert, watch what you are doing, and use common sense when operating a power tool. Do not use tool while tired or under the influence of drugs, alcohol, or medication.** A moment of inattention while operating power tools may result in serious personal injury.
- ▶ **Dress properly. Do not wear loose clothing or jewelry. Contain long hair. Keep your hair, clothing, and gloves away from moving parts.** Loose clothes, jewelry, or long hair can be caught in moving parts.
- ▶ **Avoid accidental starting. Be sure the switch is off before plugging in the power cord.** Carrying tools with your finger on the switch or plugging in tools that have the switch on invites accidents.
- ▶ **Remove adjusting keys or wrenches before turning the tool on.** A wrench or a key that is left attached to a rotating part of the tool may result in personal injury.
- ▶ **Do not overreach. Keep proper footing and balance at all times.** Proper footing and balance enables better control of the tool in unexpected situations.
- ▶ **Use safety equipment. Always wear eye protection.** Dust mask, non-skid safety shoes, hard hat, or hearing protection must be used for appropriate conditions. (Ordinary glasses are NOT proper eye protection.)

Tool Use and Care

- ▶ **Use clamps or other practical way to secure and support the workpiece to a stable platform.** Holding the work by hand or against your body is unstable and may lead to loss of control.
- ▶ **Do not force the tool. Use the correct tool for your application.** The correct tool will do the job better and safer at the rate for which it is designed.
- ▶ **Do not use the tool if the switch does not turn it on or off.** Any tool that cannot be controlled with the switch is dangerous and must be repaired.
- ▶ **Disconnect the plug from the power source before making any adjustments, changing accessories, or storing the tool.** Such preventive safety measures reduce the risk of starting the tool accidentally.
- ▶ **Store idle tools out of reach of children and other untrained persons.** Tools are dangerous in the hands of untrained users.
- ▶ **Maintain tools with care. Keep cutting tools sharp and clean.** Properly maintained tools with sharp cutting edges are less likely to bind and are easier to control.
- ▶ **Check for misalignment or binding of moving parts, breakage of parts, and any other condition that may affect the tool's operation. If damaged, have the tool serviced before using.** Many accidents are caused by poorly maintained tools.
- ▶ **Use only accessories that are recommended by the manufacturer for your model.** Accessories that may be suitable for one tool may become hazardous when used on another tool.

Service

- ▶ **Tool service must be performed only by qualified repair personnel.** Service or maintenance performed by unqualified personnel could result in a risk of injury.

- ▶ **When servicing a tool, use only identical replacement parts.** Use of unauthorized parts or failure to follow maintenance instructions may create a risk of electric shock or injury.
-

Specific Safety Rules for Routers

- ▶ **Hold the tool by the insulated handles when performing an operation in which the cutter may contact hidden wiring or its own cord.** Contact with a "live" wire will make the exposed metal parts of the tool "live" and shock the operator.
 - ▶ **Use clamps or another suitable means to support and secure the workpiece to a stable platform.** Holding the workpiece by hand or against your body is unstable and may lead to loss of control.
 - ▶ **Always make sure the work surface is free from nails and other foreign objects.** Cutting into a nail can cause the bit and the tool to jump and damage the bit.
 - ▶ **Keep hands away from the cutting area.** Keep your second hand on the auxiliary handle. If both hands are holding the tool, they cannot be cut by the bit.
 - ▶ **NEVER hold the piece being cut in your hands or across your leg.** It is important to support the work properly to minimize body exposure or loss of control.
 - ▶ **After changing the bit or making any adjustments, make sure the collet nut and any other adjustment devices are securely tightened.** A loose adjustment device can unexpectedly shift, causing loss of control, and loose rotating components can be violently thrown.
 - ▶ **Never start the tool when the bit is engaged in the workpiece.** The cutting bit may grab and cause loss of control.
 - ▶ **Always feed the router against the rotation of the bit (called push-cutting).**
 - ▶ **Never operate the router with the cutting tool engaged in the workpiece without locking the plunge lock knob.** Unexpected changes in cutting depth can result in a violent loss of control.
-

Router Feed Direction

For safety and control, the router should always be fed in the direction against the rotation of the bit. This is called push-cutting (among other names). Feeding the router in the same direction as the bit rotation is called climb-cutting, and is extremely dangerous.

When fed in the push-cut direction, the router bit resists forward movement and provides greater control to the operator.

If a router is fed in the climb-cut direction, the router bit tends to self-feed, climb, or walk its way down the edge of the workpiece. Feeding in this direction can, and will, cause the router to grab suddenly and jerk down the workpiece, resulting in loss of control.

Special care needs to be taken when making dado cuts and plunge cuts with a router because one side of the bit is push-cutting, and the other side is climb-cutting. This can have unpredictable results as each side of the bit engages the workpiece.

Refer to the "Feed Direction Rules" section on page 12 for additional information.

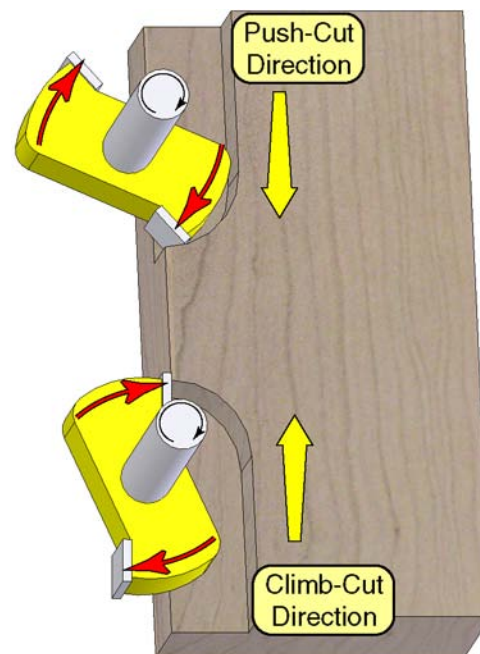

Respiratory Exposure Warning

Various dust created by power sanding, sawing, grinding, drilling and other construction activities contains chemicals known (to the State of California) to cause cancer, birth defects or other reproductive harm. Some examples of these chemicals are:

- ▶ lead from lead-based paints,
- ▶ crystalline silica from bricks, cement, and other masonry products,
- ▶ arsenic and chromium from chemically-treated lumber.

The risk from these exposures varies, depending on how often you do this type of work. To reduce your exposure to these chemicals: work in a well ventilated area, and work with approved safety equipment, such as dust masks that are specially designed to filter out microscopic particles.

Tool Description

This section provides a quick overview of the components and features of the OF 1400 EQ router. Additional information about these components and features will be discussed later in the manual.



Figure 1

- a. **Trigger (On/Off Switch).** Used to turn the router On and Off.
- b. **Trigger Lock.** This locks the power trigger in the On position.
- c. **Speed Control.** This dial is used to change the motor speed of the router. The higher the number, the faster the motor speed.
- d. **Depth Stop Post Handle.** The depth stop post is raised or lowered with this handle.
- e. **Plunge Depth Gauge.** Indicates the depth of plunge. This is used in conjunction with the other depth setting features to determine the depth of plunge.
- f. **Plunge Depth Pointer.** This sliding pointer is used to set the plunge depth relative to a basepoint setting.
- g. **Plunge Stop Micro-adjust Knob.** The micro adjustment knob is used to fine tune a depth setting by small increments.
- h. **Plunge Lock Knob.** This dual action knob acts as an auxiliary handle for the router, and also clamps the router in a fixed-plunge position.
- i. **Depth Post Lock.** This lever locks the depth post in position.
- j. **Depth Stop Turret.** The turret allows for three rapid-change depth settings based on a single depth stop. Each position can be adjusted for individual depth.
- k. **Accessory Latches (2).** The accessory latches are used to secure optional accessories below the base of the router, such as a template guide.
- l. **Outrigger Clamping Knob.** The clamping knob is used to secure outrigger accessories to the router base, such as an edge guide accessory.
- m. **Dust Collection Port.** The removable dust collection port can be connected to a vacuum system for chip removal.
- n. **Dust Collection Port Latch.** The latch secures the dust collection port in position.
- o. **Ratcheting Spindle Lock.** The spindle lock stops the shaft from turning during a bit change. The dual action lever locks the spindle in one direction and ratchets in the opposite direction for faster bit changing. Press the lever on the left to tighten the collet nut, and press it on the right to loosen the collet net.
- p. **Collet.** The collet holds router bits in place.

Power Controls

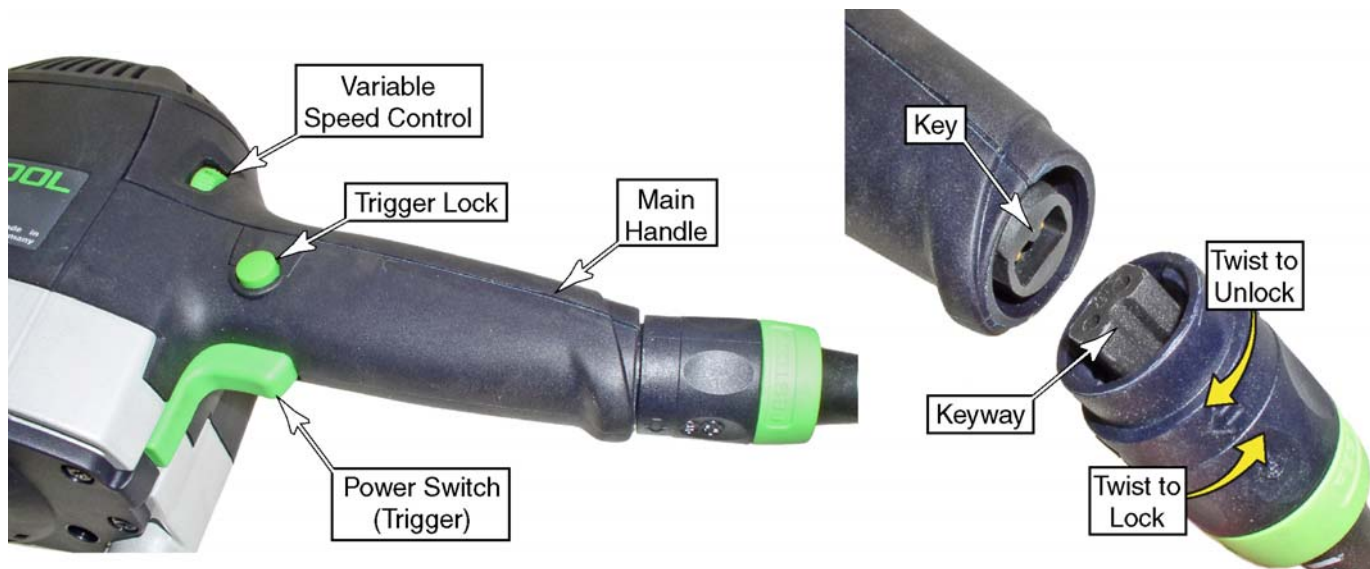

To operate the router:

1. Set the motor speed by turning the variable speed control knob to the desired speed according to the router speed settings table on page 13.
2. Start the router by pulling up on the power switch.
3. If desired, lock the power switch in the on position by holding in the trigger lock button, and then release the power switch.
4. To release the trigger lock, pull up then release the power switch.

The OF 1400 EQ router has a removable power cord for added convenience. To install the power cord:

1. Insert the cord into the receptacle on the router's handle with the keyway lined up with the key.
2. Twist the locking knob in the direction shown.
3. Reverse the procedure to remove the cord.

Technical Specifications

Power Consumption	1400 Watts (12 amps @ 120 volts)
Weight	4.5 kg (9.9 lbs)
Speed Range	10,000 to 22,500 RPM (no load)
Quick Height Adjustment	70 mm (2.76")
Fine Height Adjustment	8 mm (0.31")
Maximum Bit Diameter	63 mm (2.5")
Collet Sizes	1/2-in. and 8mm Standard 1/4-in. and 3/8-in. Optional
Certifications	IEC 745, UL745, CSA C22.2/745

All metric dimensions are binding.

Changing Router Bits

The OF1400 EQ has the unique feature of a ratcheting spindle lock. Because the spindle lock is ratcheted, you don't need to remove the wrench to make multiple turns of the collet nut; simply move the wrench back and forth.



The router also has a very deep spindle bore (2¼ inches). Very few router bits are long enough to bottom out in the spindle. This is important, because if a router bit is inserted so deep into the spindle that it touches the bottom, the collet will not tighten properly and the bit can come loose. The router bit gripping surface of the collet is approximately 1 inch deep (shown above).

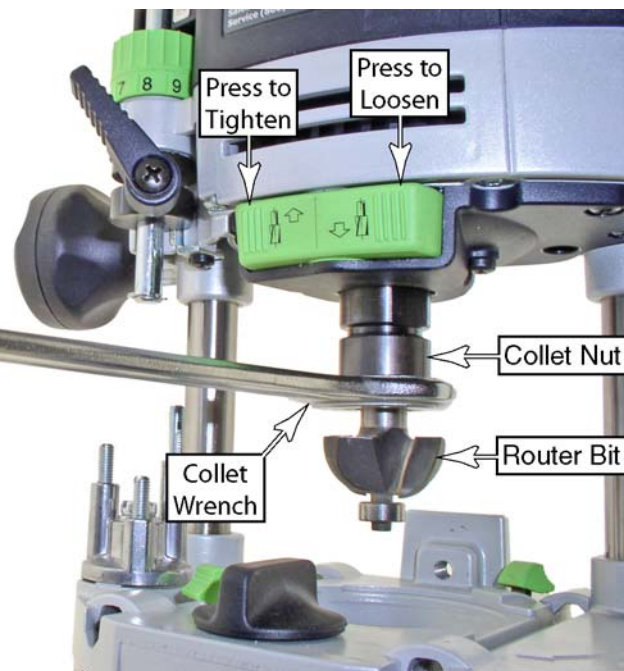

1. Unplug the router for safety.
2. Insert the router bit into the collet at least one inch. This will vary with different bits, but most of the shank should be within the collet. Do not exceed two inches.
3. Place the collet wrench on the collet nut.
4. Press the left-hand side of the spindle lock.
5. Tighten the collet nut firmly.
6. Remove the wrench from the collet nut before starting the router.
7. To remove a router bit, follow the same procedure except press the right-hand side of the spindle lock.

i Do not tighten the collet nut without a bit in the collet. Doing so will distort the collet.

Changing Collets

The router can use a variety of router bits with different shank diameters by changing the collet. The router can use 1/4-in., 3/8-in., 1/2-in., and 8mm collets. The collet is integral with the collet nut, so unscrewing the collet nut will pull the collet out of the tapered spindle.

To change collets, unscrew the existing collet all the way out of the spindle and screw the new collet into the spindle.

Examples of 8mm and ½-inch collets are shown to the right.

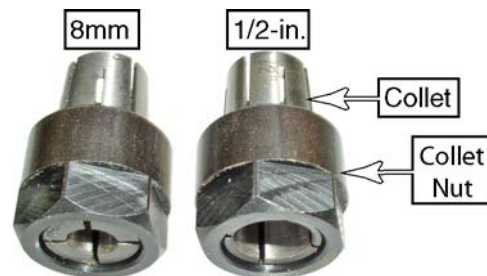

Dust Collection

Dust Extraction Hood

The dust extraction hood can be installed on the top of the router base and connected to a vacuum for dust collection.

To install the dust extraction hood, insert the mounting tabs into the router base, and turn the retaining latch to the locked position.

Make sure the router bit won't cut into the extraction hood.

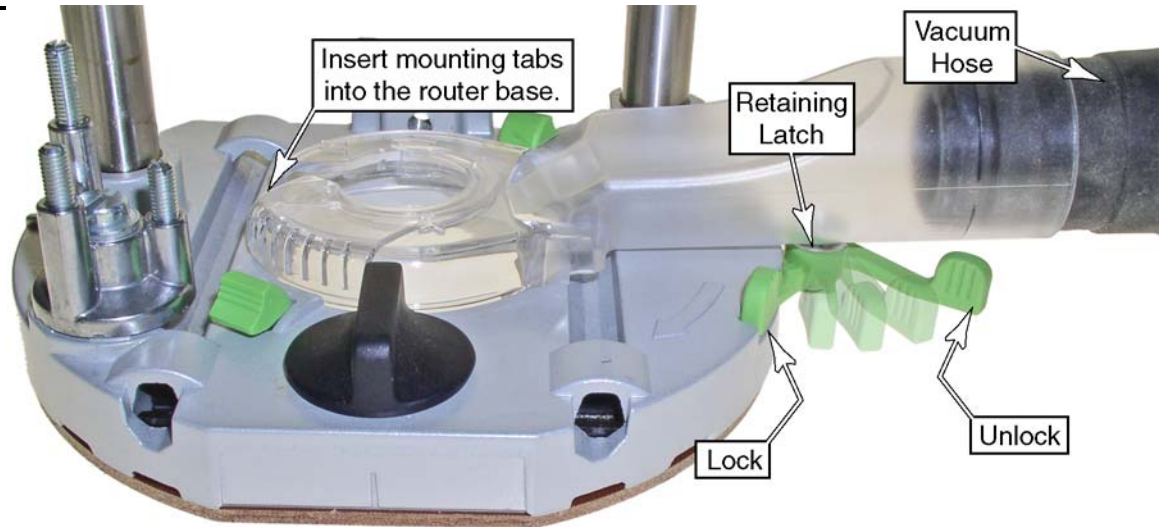

Chip Diverter

The chip diverter is used for edge forming to keep the routing debris from coming back toward the operator. This can be used with or without dust extraction. To install the chip diverter:

1. Lay the router on its side.

2. Insert the tabs of the chip diverter into the accessory slots and push in until you hear the locking tabs click.
3. Verify that the diverter is fully seated and latched. Note the position of the locking tab in the upper left picture when the diverter is not fully latched.

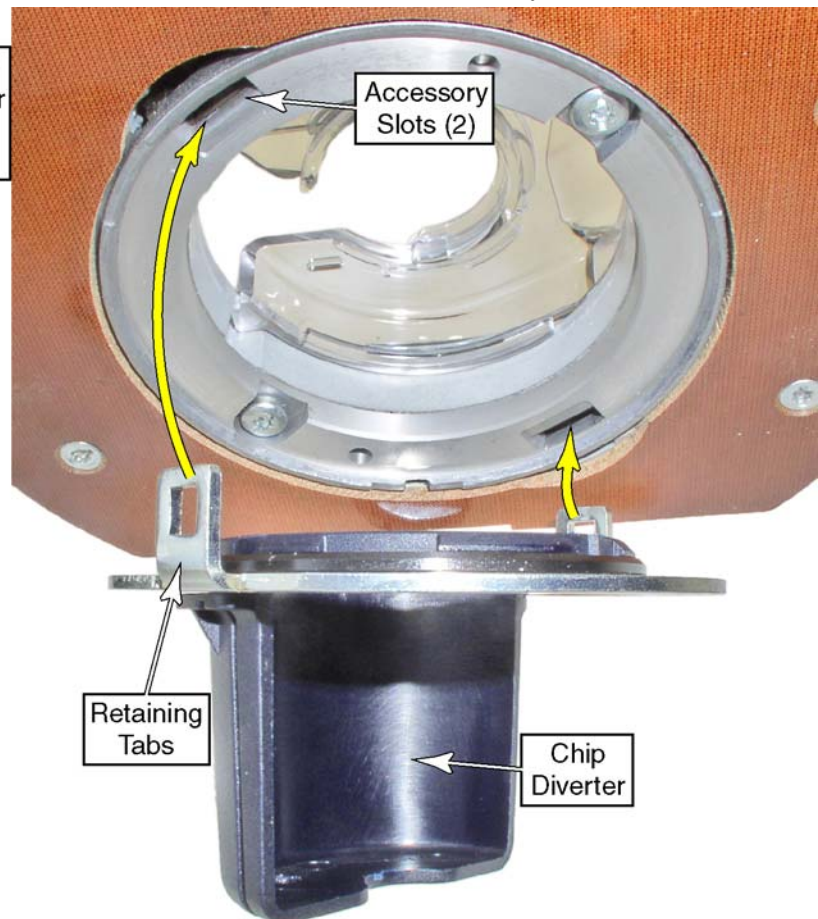
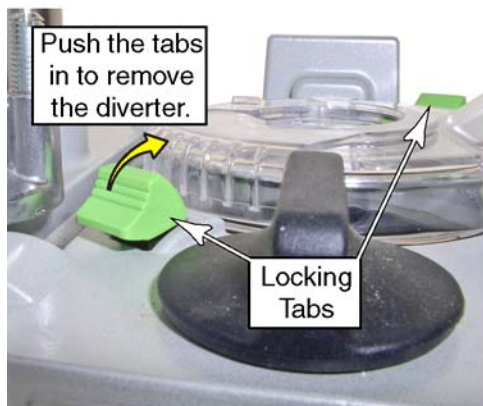

Setting the Plunge Depth

Using Basic Plunge Features

The basic plunge features are used for the majority of operations including both fixed depth routing and plunge routing.

1. Unplug the router for safety.
2. Loosen the depth stop clamping lever so the depth stop is free to move up and down.
3. Lower the router to the approximate depth desired and lock the depth stop clamping lever.
 - ▶ **Note:** With the depth stop clamped, the router can be raised and lowered as needed to check the final depth of cut.
4. Fine tune the depth stop by turning the fine adjustment dial. Use the following guidelines:
 - ▶ To increase the depth, turn the dial toward the increasing numbers.
 - ▶ To decrease the depth, turn the dial toward the decreasing numbers. (Do not decrease the depth setting with the plunge lock knob tightened.)

- ▶ Each index number represents 0.1 mm (0.004 inch) of depth, and one full turn represents 1 mm (0.040 inch) of depth.
5. Operate the router as described in the “Basic Routing” section on page 12.

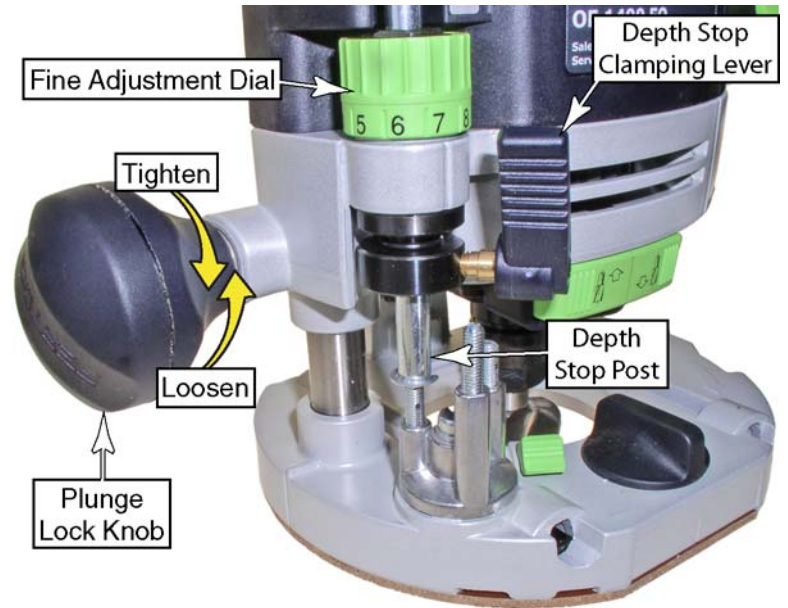

Using the Plunge Depth Gauge

The depth gauge is used to set the cutting depth relative to a basepoint setting. A typical example where this is used is when the cutting depth needs to be relative to the surface of the workpiece, such as a dado cut.

1. Unplug the router for safety.
2. Loosen the plunge lock knob $\frac{1}{4}$ -turn and lower the router until the router bit touches the basepoint (such as the surface of the workpiece).
3. For convenience, you may wish to re-tighten the plunge lock knob.
4. Set the basepoint (see the left-hand image):
 - a. Lower the depth stop until it touches one of the posts on the turret.
 - b. Slide the index pointer down to the zero-setting.
 - c. Note that the depth stop lever is unlocked.
5. Set the desired depth (see the right-hand image):
 - a. Raise the depth stop until the index pointer is pointing to the desired depth on the gauge (the example in the right-hand image shows a final depth setting of 10 mm).
 - b. Lock the depth stop lever.
6. Release the plunge lock.
7. Operate the router as described in the “Basic Routing” section on page 12. The depth of plunge will be the amount set in step 5.a above.

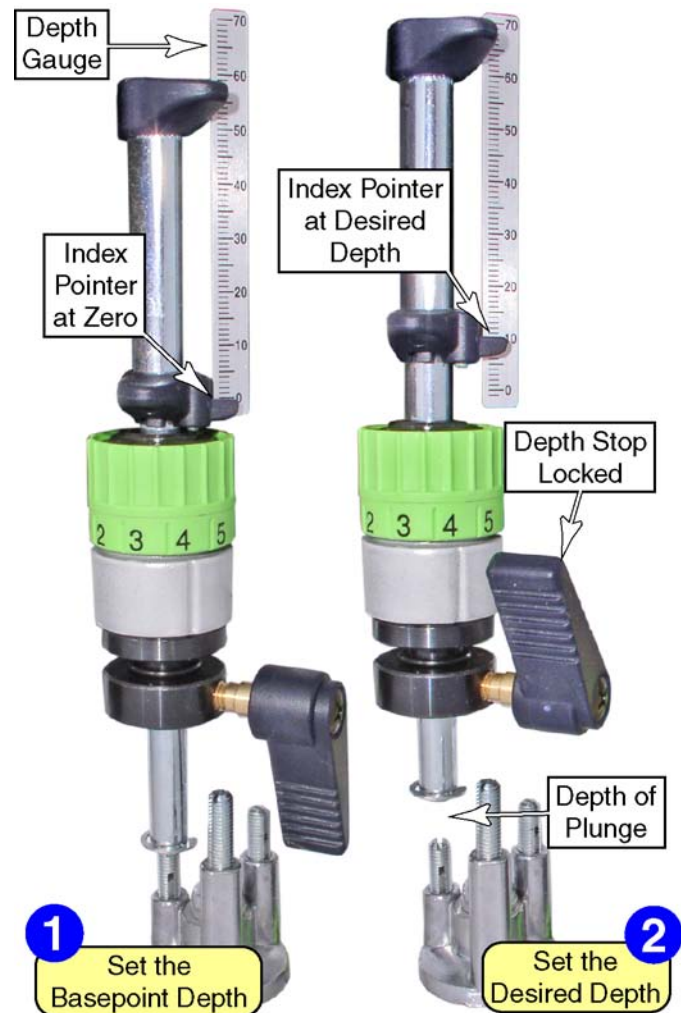

Using the Depth Stop Turret

The depth stop turret allows you to easily change between different depths without changing the depth stop settings.

- ▶ The turret posts can be calibrated for repeatable depth settings from a basepoint depth, such as making dado cuts.

Calibrating the Turret Posts

The height of the turret posts may be left at the default settings, but you may wish to set the heights based on frequently performed tasks. Use this procedure if you want to set the difference between post heights to be specific to your needs.

- ▶ The actual height of each post is not critical; the difference in height between posts is critical.
- ▶ If all three posts are to be calibrated, begin with the lowest two posts, and work upward from there.

1. Unplug the router for safety.
2. To ensure the router depth does not change, tighten the plunge lock knob.
3. Set the Basepoint (see the left-hand image):
 - a. Rotate the turret to the lower of the two posts to be adjusted. This lower post height is not adjusted, but serves as the baseline for adjusting the higher post(s).
 - b. Release the depth stop lever and lower the depth stop to the post.
 - c. Slide the index pointer down to the zero-position.
4. Calibrate the adjacent post (see right-hand image):
 - a. Lift the depth stop out of the way and rotate the turret to the higher post to be calibrated.
 - b. Lower the depth stop to the post.
 - ▶ **Do not** re-zero the index pointer.
 - ▶ The index pointer will be showing the difference between the two posts heights.
 - c. Adjust the height of the higher post until the index pointer is pointing to the desired difference between post heights:
 - ▶ Do not change the height of the lower post.
 - ▶ Lift the depth stop out of the way (or rotate the turret) to adjust the post height.
 - ▶ To decrease the difference between posts, turn the higher post clockwise.

- ▶ One of the most common tasks for the turret is making successively deeper cuts to achieve a final depth that cannot be completed in a single pass.

- ▶ To increase the difference between posts, turn the higher post counterclockwise.
5. Verify the adjustment by lowering the depth stop back down to the higher post and reading the result on the depth gauge.

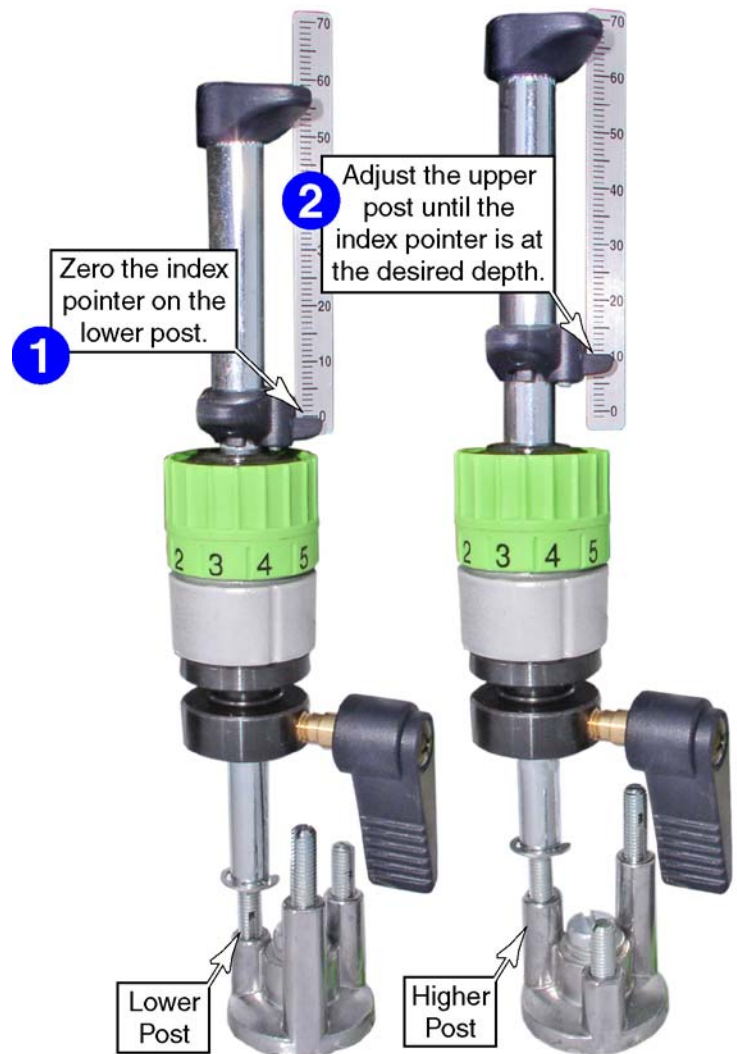

Using the Turret for Successive Depths

The turret can be very useful when making deep plunge cuts because successively deeper cuts can be made without readjusting the router (see Multi-depth Ploughing on page 15).

1. Unplug the router for safety.
2. Rotate the turret to the lowest post and set the depth stop for the final desired depth as described on page 9.
3. Rotate the turret to the highest post, and operate the router as described in the “Basic Routing” section on page 12. This will route the workpiece at the shallowest setting.
4. Next, rotate the turret to the middle post, and perform the routing operation again. The depth will be slightly deeper than the first.
5. Finally, rotate the turret to the lowest post and complete the final pass.

Using the Turret for Precision Depths

This procedure is very helpful when you have day-to-day plunging operations that use the same depth relative to a basepoint. You can quickly reset the depth even after changing the router bit.

Before using this procedure, make sure you perform the “Calibrating the Turret Posts” procedure on page 11 to set the difference between turret posts to the precise depth you need.

For example, using the calibration procedure, you could set the difference between posts as follows:

- ▶ 1st to 2nd post to ¼ inch
- ▶ 2nd to 3rd post to ½ inch
- ▶ 1st to 3rd post to ¾ inch

Basic Routing

Fixed Depth

Fixed depth routing is typically performed with router bits with a guide bearing that rides along the edge of a workpiece. The depth of cut is fixed before the router is engaged.

1. Verify that the router bit is properly secured, and the router is ready for operation.
2. Secure the workpiece to a stable surface.
3. Lower the router to the desired depth and tighten the plunge lock knob.

1. Unplug the router for safety.
2. Decide which two posts provide the difference in height necessary for the operation.
3. Rotate the turret to the higher of the two posts.
4. Lower the router down until the router bit touches the surface of the workpiece.
5. Lock the depth stop at this depth.
6. Rotate the turret to the lower of the two posts.
7. Operate the router as described in the “Basic Routing” section below.

4. Set the router speed according to the speed settings table on page 13.
5. Place the router on the workpiece, but make sure the bit is not touching the wood.

CAUTION: Starting the router with the bit in contact with the workpiece may cause a loss of control and injury.

6. Firmly grasp both handles of the router and pull up on the power switch.
7. Advance the router through the cut according to the feed direction rules below.

Feed Direction Rules

- ▶ Always feed the router against the rotation of the bit. This prevents the router from grabbing the wood and self-feeding, resulting in a loss of control.
- ▶ When routing around the exterior of a shape, feed the router counterclockwise.
- ▶ When routing around the interior of a shape (such as the circle shown below), feed the router clockwise.
- ▶ Begin routing across the end grain first (as indicated with “Start Here” in the figure below). This reduces tearout at the corners.

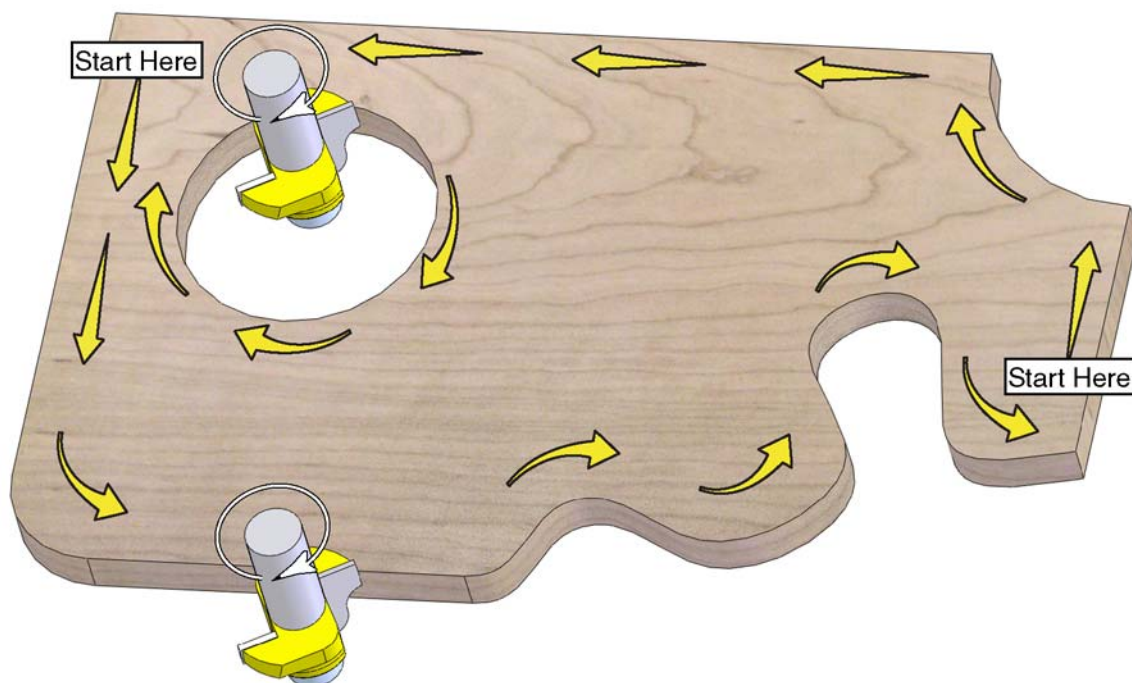

Plunge Routing

Plunge routing is any operation where the router is lowered down into the cutting area after the router has been started. Most often this involves router bits that do not have a guide bearing, but can also be used for interior cutting (such as the circular cut shown on page 12).

⚠WARNING: Take care while plunge routing to maintain control of the router at all times. For many plunge operations, one side of the router bit will be climb-cutting and the other side will be push-cutting. This can lead to a loss of control and/or poor cut quality.

1. Verify that the router bit is properly secured and the router is ready for operation.
2. Secure the workpiece to a stable surface.
3. Set the router speed according to the speed settings table below.

4. With the router turned off, place the router on the workpiece.
5. Firmly grasp both handles of the router and pull up on the power switch.
6. Lower the router to the desired depth, tighten the plunge lock knob, and advance the router through the cut.

⚠WARNING: Failure to tighten the plunge lock knob may result in a loss of control and injury.

- ▶ For router bits with guide bearings, advance the router through the cut according to the feed direction rules discussed on page 12.
- ▶ When using router bits without a guide bearing, or with an external guide rail, follow the tips in "plough cuts" below to keep the router tracking properly.

Plough Cuts

When making plough cuts, as shown to the right, three sides of the router bit are engaging the workpiece. This can lead to undesired changes in the path of the router.

- ▶ One side of the router bit is climb-cutting, and this tends to propel the router forward.
- ▶ One side of the router bit is push-cutting, and this tends to slow the feed rate.
- ▶ The leading edge of the router bit pushes the router sideways, opposite the rotation of the bit.

The opposing climb-cutting and push-cutting sides will cause the router to advance with a jerking motion.

To avoid drift from the leading edge of the router bit, position a guide rail on the push-cutting side of the router (toward the middle in the image to the right).

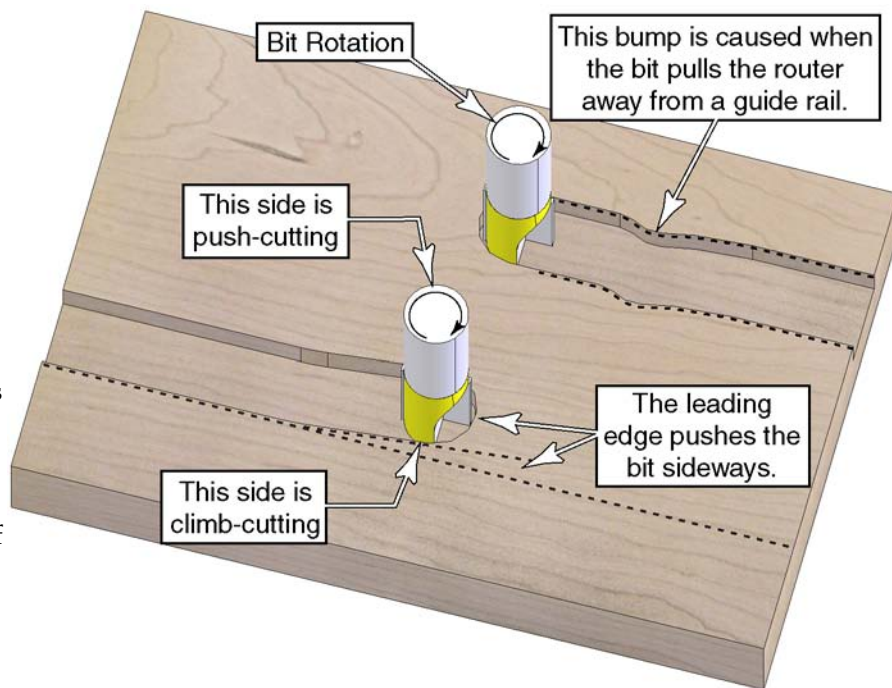

Router Speed and Feed Rate

The optimal router speed for an operation is determined by the diameter of the router bit and the type of material being machined. The important factor is the speed that the router bit tips move past the workpiece. The tip speed is proportional to the diameter of the router bit.

If the tip speed is too high, friction causes excessive heat and the workpiece can be scorched. Too low of a tip speed and the bit will tear the material instead of cutting (for aluminum, the bit will grab the workpiece).

The feed rate of the router past the workpiece is a function of the router speed, material type, and amount of material being removed. Too fast of a feed rate can cause chatter and tearout. Too slow of a feed rate can burn or scorch the workpiece.

Material	Router Speed Settings					Feed Rate
	Bit Diameter (inches)					
	≤1/2	3/4	1	1 1/4	≥1 1/2	
Pine	5-6	5-6	4-6	3-5	3-5	Fast
Oak	5-6	4-6	4-5	3-5	2-4	Moderate
Cherry	3-5	3-5	3-4	2-4	2-3	Moderate
Maple	3-5	3-5	3-4	2-4	2-3	Slow
Particleboard and MDF	5-6	5-6	4-6	3-5	3-5	Fast
Soft Plastics	3-5	3-5	3-4	2-4	1-3	Slow
Hard Plastics	2-4	1-4	1-3	1-2	1-2	Slow
Aluminum	3-4	3-4	2-3	2-3	1-3	Slow

Advanced Routing Techniques

Starting a Cut Near a Corner

When routing a profile on the edge of a board, it can be difficult starting the cut at the corner without having the router lurch backward and cut into the adjoining side of the board (going past the corner). To avoid having the router catch unexpectedly, firmly hold the auxiliary handle (plunge lock knob) with one hand, and pivot the router with the main handle. This method gives you more control over the router, even if it were to unexpectedly catch.

i This procedure is described and shown with right-handed operation. For left-handed operation, reverse the hand positions described in the procedure and shown in the photograph.

1. Clamp the workpiece to a stable surface.
2. Set the router bit depth and firmly tighten the plunge lock knob.
3. Set the speed control according to the table on page 13.

4. Place the router on the workpiece with the router bit positioned slightly ahead of the corner (away from a right-handed operator as shown) and about ½ to 1 inch away from the workpiece.
5. Firmly place your left forearm on the workpiece and grasp the auxiliary handle (plunge lock knob) of the router. Your hand will serve as the pivot point for this operation, so you want to keep it held as firmly in place as possible.
6. Place your right hand on the main handle and start the router.
7. Nibble away at the corner by rocking the router back and forth taking light, controlled cuts. Gradually move your left hand as necessary to cut deeper.
8. Finish routing the rest of the edge as normal.



Multi-pass Cuts

Nearly all routing operations can be improved by making multiple passes. In some cases the routing operation would remove too much material to be completed safely in a single pass. In other cases, the finished cut is improved by making

a shallow, clean-up pass. Depending on the type of cut being made, some multi-pass cuts are made by varying the depth and others are made by varying the position. The different types are shown below.

Multi-depth Ploughing

When ploughing out large volumes of material or making deep dados, make the cuts using successively deeper settings until the final depth is reached. The three positions of the depth stop turret are well suited for this type of operation.

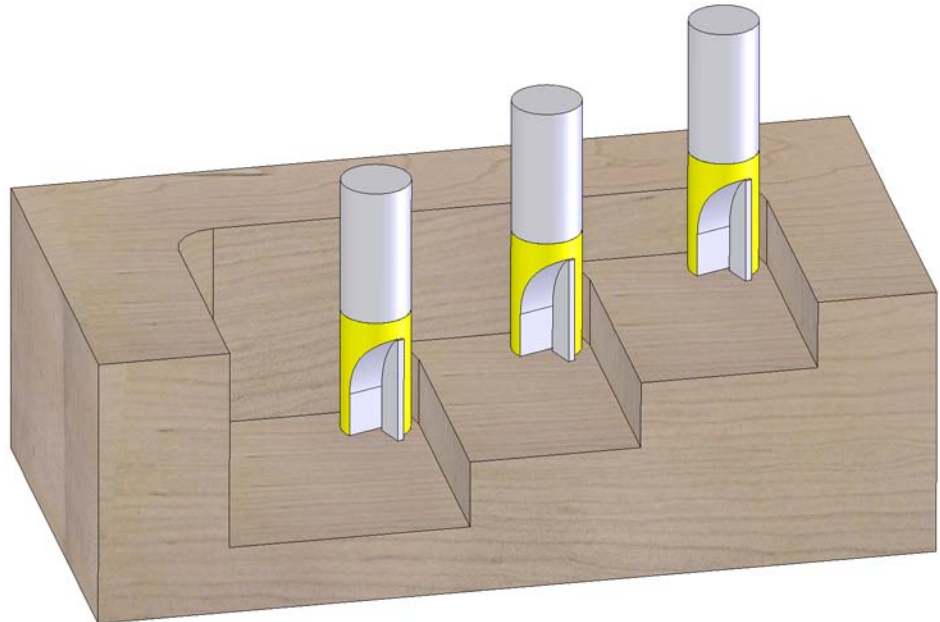

Multi-depth Profiles

There are several reasons for making multiple passes with edge forming, profile cutters.

- ▶ For large profiles, a shallow first-pass can be made to remove the bulk of the material.
- ▶ Several shallow passes can be made for better control with large router bits.
- ▶ A final, shallow, clean-up pass can improve the quality of the finished edge.

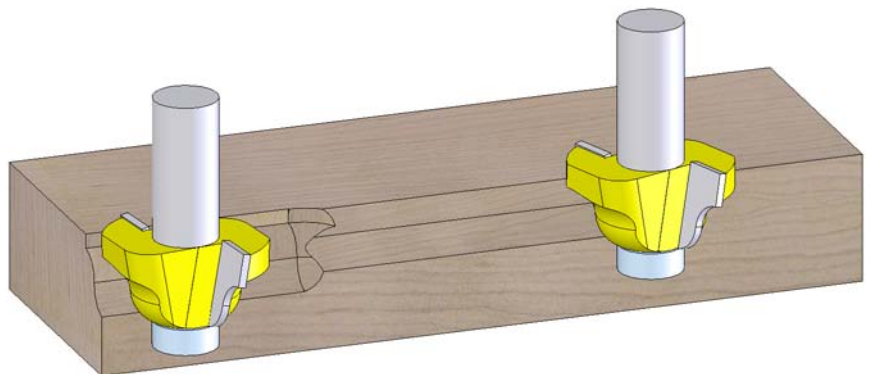

Multi-position (horizontal) Profiles

Altering the horizontal position of a router cut for multiple passes is required whenever the profile cuts back into the workpiece in a way that changing the depth would destroy the desired profile. A common example of this is a slot cutter. A common problem with this type of cutter is that sharp corners between the cut profile and the uncut wood edge will tend to tear out. This can be reduced by making a very shallow scoring cut before making a full profile cut.

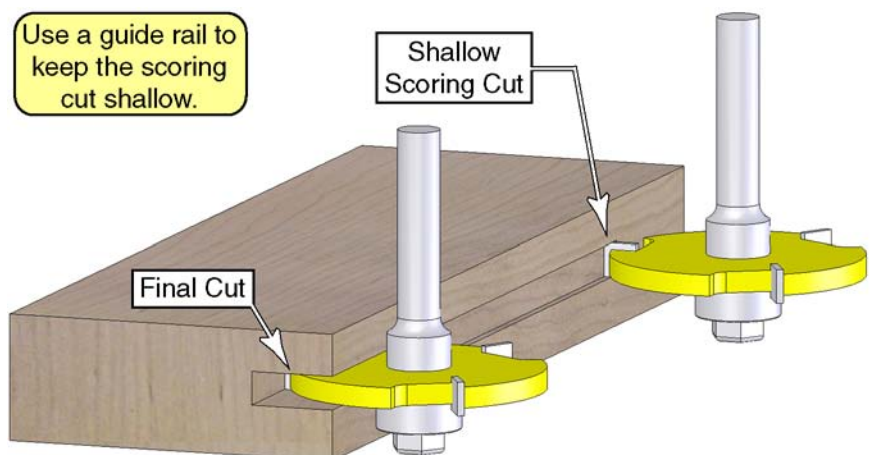

Pre-cutting Dovetails and Keyways

Dovetail and keyway cutters are inherently weak because the upper shank of the bit is smaller than the cutting edges. If the stress on the bit is too great, the cutting tip can break. To reduce the stress on the cutter, it is common practice to plough out the majority of the material with a straight bit. The depth of the straight bit should be slightly shallower than the depth of the final bit so the bottom of the profile remains square.

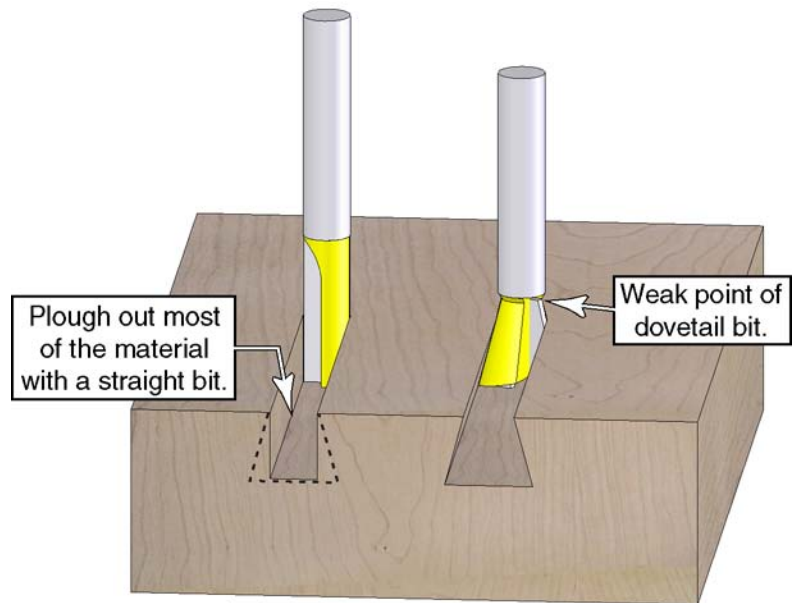

Tips for Successful Routing

Chipping and Tearout

One of the most common problems woodworkers will encounter when using a router is chipping and tearout of the workpiece. The following tips can reduce the occurrence of chipping and tearout.

- ▶ Take shallower passes to reach your final depth. With a shallow pass, the router bit teeth will be cutting parallel with the grain instead of arching through the grain.
- ▶ Examine the woodgrain before routing. If possible, orient the workpiece so the grain doesn't fracture. To identify the grain orientation, examine the edge grain, not the surface grain. Use the following tips:
 - ▶ If the grain orientation is not in the right direction, turn the board over. (Rotating the board to the opposite edge does not change the orientation. You must flip the board over.)
 - ▶ For tight-grained woods where the grain orientation is not obvious, look for pre-existing signs, such as small splinters at the corners. You can also use a knife to cleave the grain.

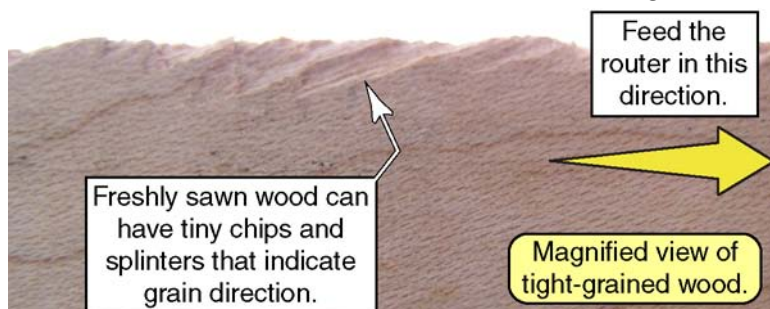

- ▶ For open pore woods such as oak, examine the capillaries on the edge of the wood. Orient the board so the router is moving away from the capillary entrance holes.

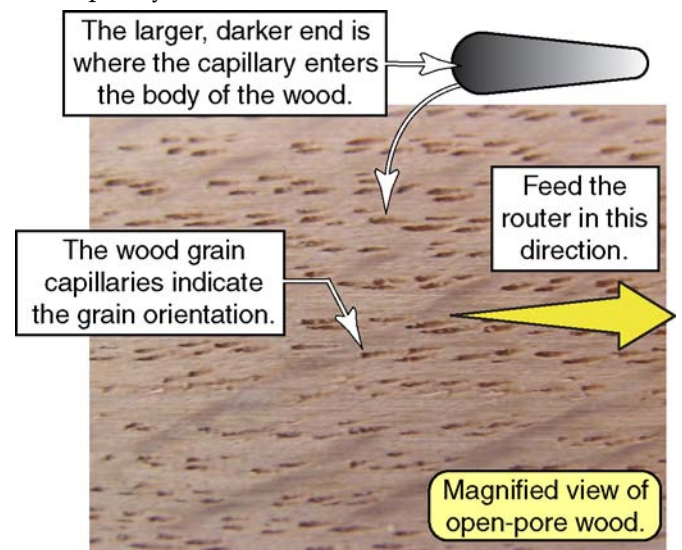

Chatter

Router bit chatter is the presence of small curves, or scallops, in the routed profile (refer to the image on page 17). The following items may cause chatter:

- ▶ Too fast of a feed rate for the router RPM.

- ▶ Trying to take too much material in a single pass.
- ▶ Chatter is more noticeable with smaller diameter router bits.

Climb-cutting with Small Diameter Bits

Disclaimer: Even though Festool does not condone the practice of climb-cutting with a router, the topic is known to exist in books and other written publications on router techniques.

This topic is presented for information only, and is intended to warn the user of the potential dangers of climb-cutting. The information below does not explain how to perform climb-cutting, but instead, what not to do. Any user attempting climb-cutting, does so at their own risk.

Climb-cutting is feeding the router in the same direction as the rotation of the bit. The inherent danger is that the router bit will tend to self-feed, or "climb" its way down the workpiece. The sole benefit for climb-cutting is that there will be less tearout in the cut. This is because the tip of the cutter enters the edge of the workpiece, instead of exiting the edge of the workpiece. This shears the wood fibers in a compressing action, and results in less tearout.

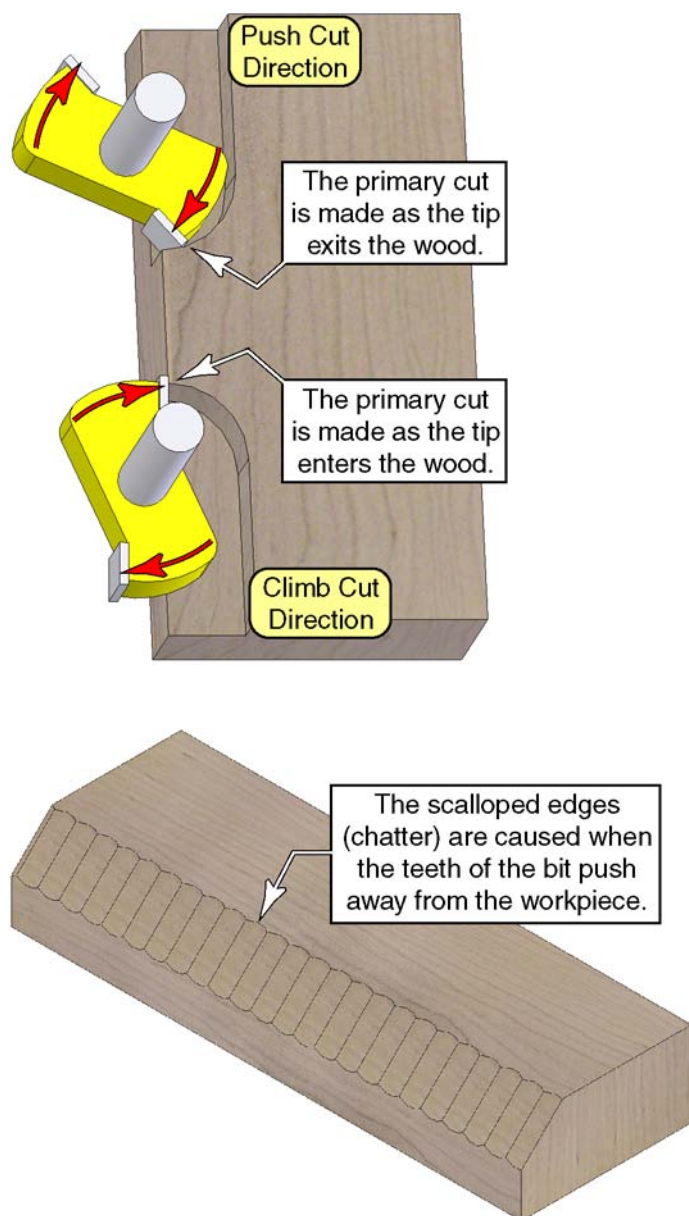

WARNING: Climb-cutting with a router is inherently dangerous! Read, understand, and follow all of the warning messages below.

⚠WARNING: There is no entirely safe method for climb-cutting. The router bit can grab the workpiece at any time.

⚠WARNING: Never attempt climb-cutting with large diameter bits.

⚠WARNING: Never, under any circumstances, attempt to climb-cut with a table-mounted router. The workpiece **will** catch and **will** be propelled off the table.

⚠WARNING: Never climb-cut around an interior cutout in a workpiece. The bit can easily catch in the corners.

⚠WARNING: The workpiece must be fully secured in place with clamping devices. Friction mats are not sufficient for securing a workpiece.

Procedure Notes

- ▶ Never let your guard down. Always be expecting the router to catch, and think ahead of how you should best react to the situation before it happens.
- ▶ As with any power tool, respect the danger, but do not operate the tool if you are afraid of the operation. Your reactions will be diminished if you are afraid of the tool or the procedure.
- ▶ Instead of relying on your reaction-time to control the router feed rate, use friction. By holding your forearm firmly to the workpiece as shown in the "Starting a Cut Near a Corner" procedure on page 14, you use friction to assist in keeping the router under control.
- ▶ Avoid climb-cutting with the router moving toward your body. More control is possible with the router pulling away from your body with your arms outstretched.
- ▶ Climb-cutting end grain does not improve the cut quality. The wood fibers are torn and compressed, and the result is a rougher finish.
- ▶ For materials that are prone to burning (such as cherry and maple) climb-cutting reduces burning because the primary cut is shearing the fibers.
- ▶ For best results, always follow a climb-cut with a clean up pass in the push-cut direction for the following reasons:
 - ▶ Climb-cutting will push the router bit away from the workpiece, making the cut shallower than expected. Push-cutting pulls the bit into the workpiece.
 - ▶ Climb-cutting will result in more chatter marks (shown to the left). Push-cutting will remove these.

Accessories

Guide Rail Attachment

The guide rail attachment is used to connect the router to a Festool guide rail system for making straight cuts.

Assembling the Guide Rail Attachment

1. Before assembling the attachment, adjust the guide rail gibs on both guide blocks.
 - a. Place the block on one of the ribs of the guide rail.
 - b. Tighten the two adjustment screws until the block fits snugly to the rib but still moves freely.

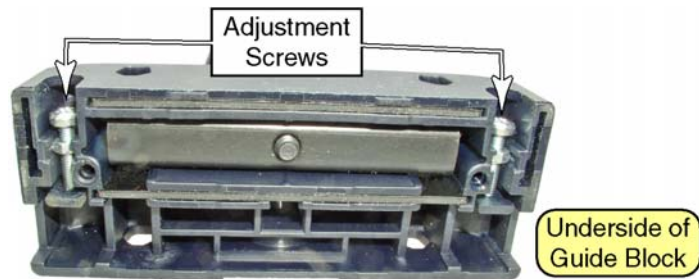

2. Thread the micro-adjust thumbwheel into either one of the two guide blocks.



3. Place the other guide block over the free end of the micro-adjust thumbwheel.



4. Insert the two guide rods through both guide blocks. Make sure the rods stick out from the second block slightly.

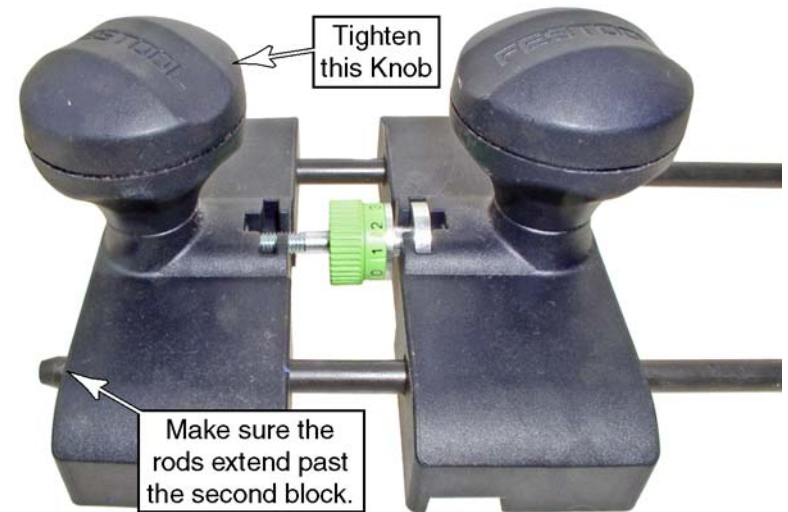

5. Insert the guide rods through the eyelets in the router base.

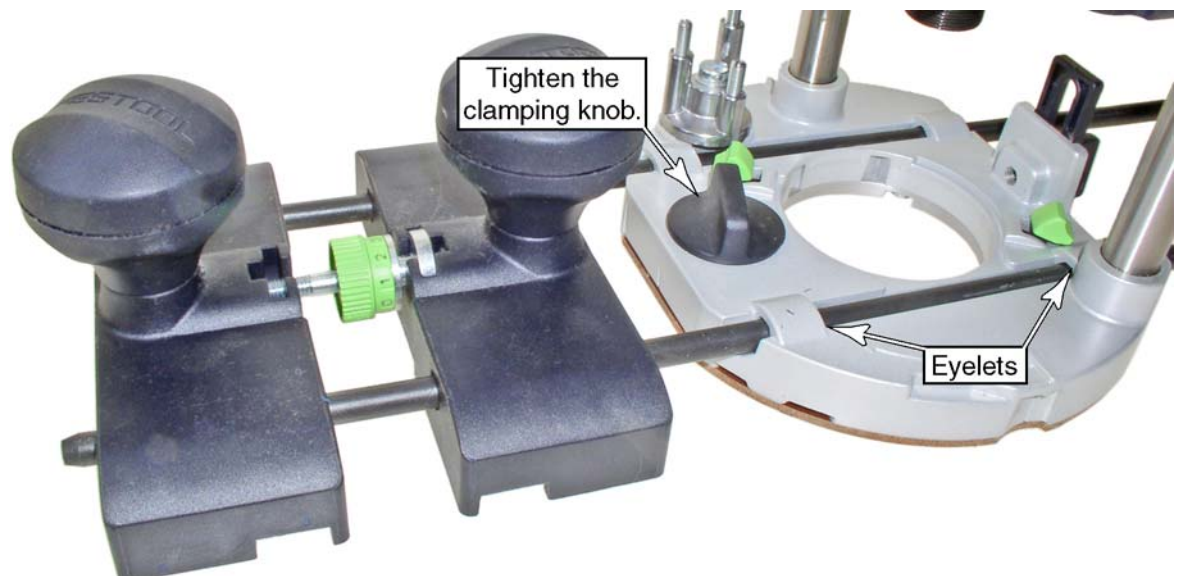

6. Install and adjust the leveling outrigger to the back of the router.
 - a. Adjust the height of the outrigger so the router is level when sitting on the edge of the guide rail.
 - b. Tighten the clamping thumbscrew.
 - ▶ The router bit radius gauge is used to indicate the location of the edge of the router bit. This is helpful for making stopped cuts. Note that this gauge indicates the radius of the bit and not the diameter.

i Make sure to raise the outrigger out of the way when not in use.

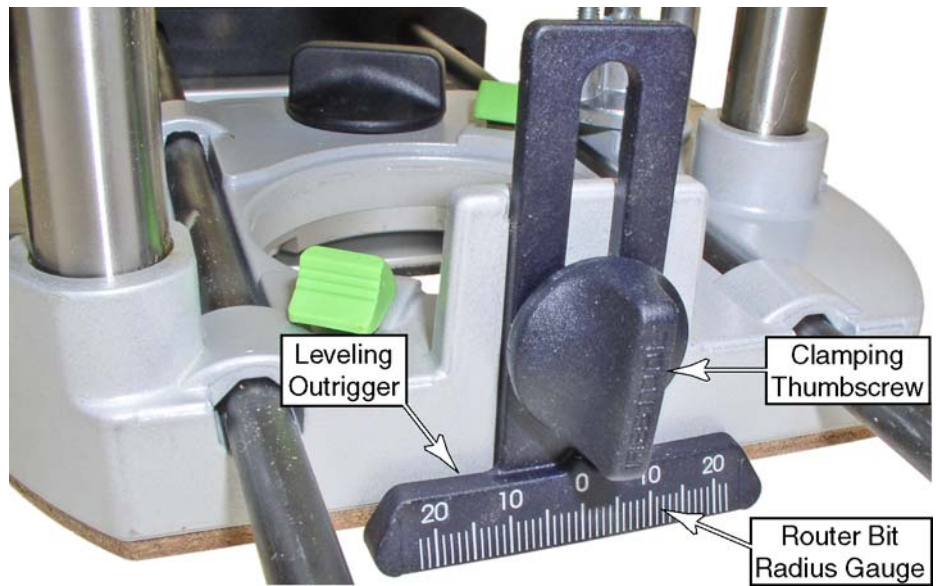

Using the Guide Rail Attachment

The Festool guide rail is used as a convenient straightedge for routing.

- ▶ The zero-clearance strip does not serve a purpose for this operation, so take care not to cut into the strip. (Keep the router bit at least 1/4-inch away from the zero-clearance strip.)
- ▶ Because the guide rail is simply serving as a straightedge, the router can be placed on the guide rail in any one of several ways, depending on the need. (Also refer to the procedure on the next page.)
- ▶ In order to utilize the micro-adjustment feature, the guide rail attachment must be installed on the guide rail with the inner guide block free to move, as shown.

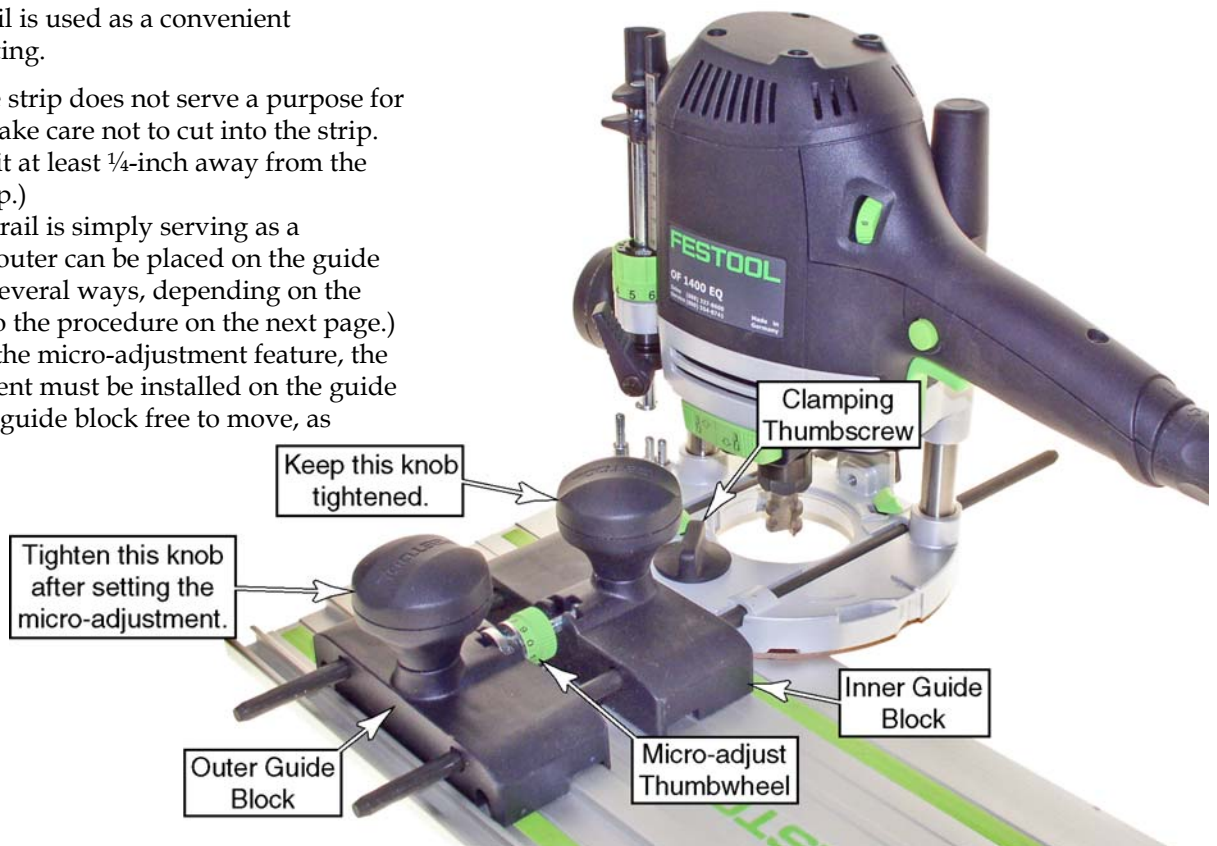

1. Clamp the guide rail to the workpiece. Note that the cutting action of the router bit may tend to move the guide rail if it is not properly clamped.
2. Place the router and guide rail attachment on the guide rail with the outer guide block on the first rib of the guide rail.
3. Verify that the leveling outrigger is at the proper height so the router base is level (see procedure above).
4. Loosen the clamping thumbscrew on the router, and slide the router in or out to its approximate final position. Retighten the thumbscrew.
5. With the inner guide block clamping knob tight and the outer guide block clamping knob loose, adjust the micro-adjust thumbwheel to set the final position of the router:
 - ▶ Each number on the wheel represents 0.1mm, and a full turn of the wheel represents 1.0 mm.
 - ▶ After the micro-adjustment is complete, tighten the outer guide block clamping knob.

Alternative Method for Using the Guide Rail Attachment

This procedure can be used for greater stability of the guide rail attachment, but does not permit the use of the micro-adjustment feature. This is helpful when using router bits prone to deflecting the position of the router, or when making precision cuts that must remain perfectly true to the guide rail.

The primary basis for this procedure is that the micro-adjustment thumbwheel is used to adjust the inner and outer guide blocks to the guide rail ribs, and provide a larger guide surface area than using the guide rail gibs (refer to page 18 for further information on the guide rail gibs).

i Note that the micro-adjustment feature cannot be used with this setup. If you need to use the micro-adjustment feature to set the router's position, use the procedure on page 19.

1. Clamp the guide rail to the workpiece. Note that the cutting action of the router bit may tend to move the guide rail if it is not properly clamped.
2. Place the router and guide rail attachment on the guide rail with both guide blocks on the ribs of the guide rail.

3. Use the micro-adjust thumbwheel to adjust the guide blocks to fit the guide rail.
 - ▶ The interior edges have a larger bearing surface, so moving the two guide blocks apart makes the guide more stable.
 - a. Loosen the clamping knob on the inner guide block.
 - b. Move the two guide blocks apart by turning the micro-adjust thumbwheel toward the increasing numbers, until the guide blocks fit snugly to the guide rail ribs, but not so tight that the guide doesn't slide freely.
 - c. Re-tighten the clamping knob.
4. Verify that the leveling outrigger is at the proper height so the router base is level (refer to the "Assembling the Guide Rail Attachment" procedure on page 18).
5. Adjust the position of the router.
 - a. Loosen the clamping thumbscrew on the router base.
 - b. Slide the router in or out to its final position.
 - c. Retighten the thumbscrew.

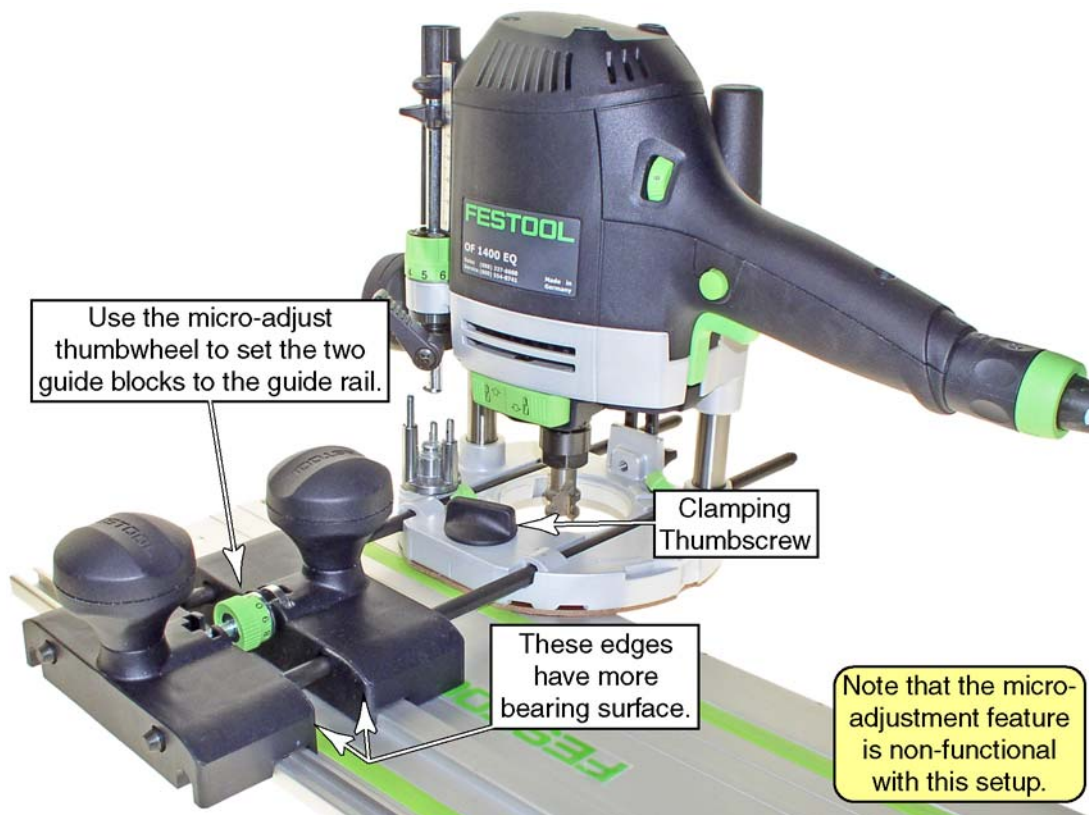

Edge Guide

The edge guide is used for guiding the router relative to the edge of a workpiece. This can be used for interior plunge routing (such as fluted columns) or for edge forming. While

the operations are similar, there are additional setups necessary for edge form routing.

Edge Forming Setup

When using the edge guide for edge forming, the router bit will be within the cutout of the edge guide (as shown to the right).

- ▶ The two fence plates need to be separated enough to clear the router bit so the bit does not cut the fence.
 - ▶ There are two options for dust collection. The standard dust extraction hood may be used (see page 9), or the optional dust chute may be attached to the underside of the edge guide. (Both dust extraction options may be used together, but the results may not be as expected.)
1. Loosen the four mounting screws on the fence plates and slide the plates apart enough to clear the router bit.
 2. Retighten the mounting screws.
 3. If desired, slide the dust chute under the mounting tabs until it clicks into place.

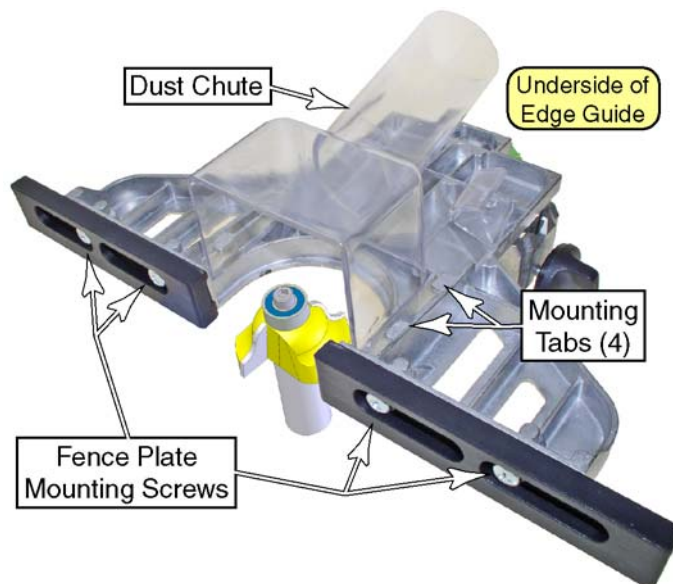

General Setup

The same general setup is used for both interior and edge form routing. The image to the right shows an interior routing setup.

1. Insert the guide rods through the edge guide as shown, and tighten the clamping thumbscrews.
2. Insert the other end of the guide rods through the eyelets in the router base.
3. Set the approximate position of the router, and tighten the clamping thumbscrew on the router base.
4. To set the final position of the router using the micro-adjust feature:
 - a. Loosen the micro-adjust clamping knob on the edge guide.
 - b. Turn the micro-adjustment dial to set the position of the router.
 - ▶ Turning the dial toward increasing numbers moves the router away from the edge guide.
 - ▶ Each number represents 0.1 mm, and a full revolution is equal to 1.0 mm.
 - c. Retighten the clamping knob.
5. Make sure you operate the router from left to right to keep the edge guide tight to the workpiece. (Refer to the discussion on "Plough Cuts" on page 13.)

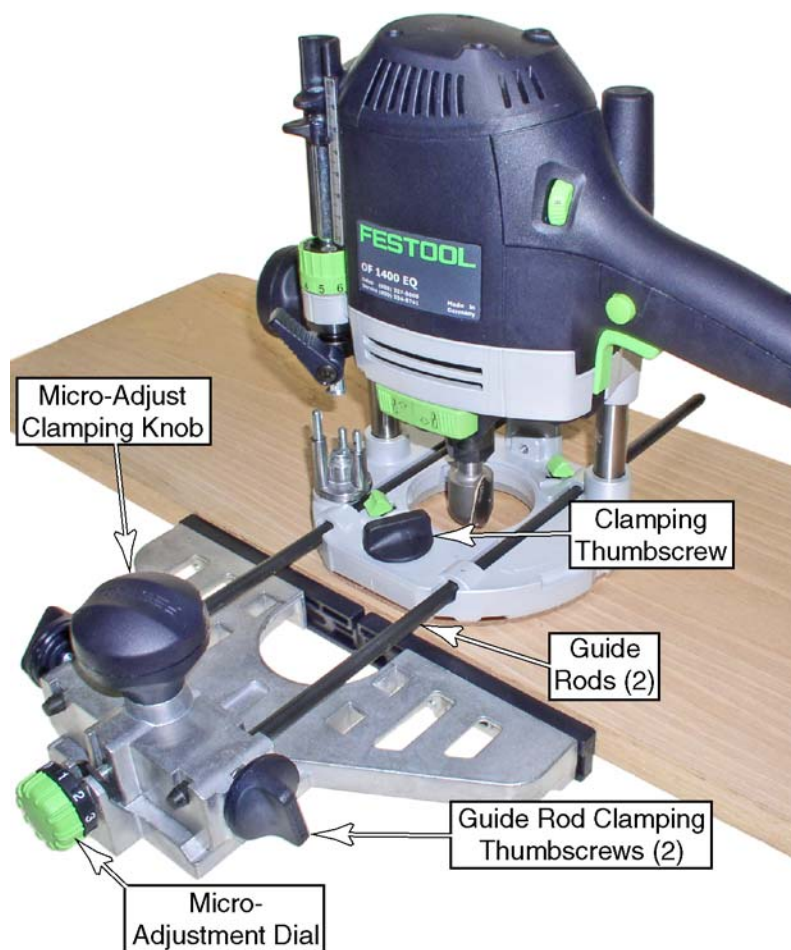

Template Guides

Template guides (also known as copy rings) are used to control the position of the router relative to an external pattern or template. This permits you to follow an external pattern even if the router bit does not have a guide bearing. The OF 1400 EQ router package may include either a standard Festool copy ring, a universal template guide adapter, or both. The template guide adapter allows you to

use universal guides from other manufacturers with your Festool router.

The function of the Festool copy ring and the universal template guide adapter are the same, except with the universal guide adapter you provide the template bushing. This allows you to use template guides that you already own with your Festool router.

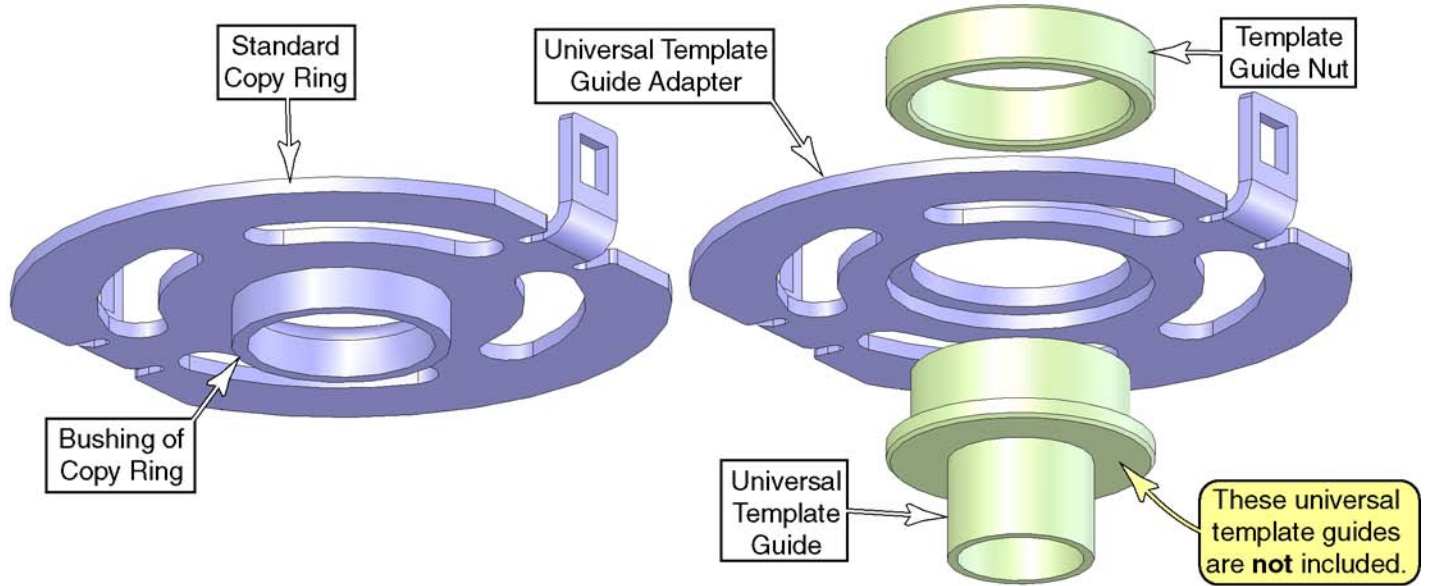

Using a Template Guide

- ▶ To install the template guide to the router base, follow the same procedure for installing the Chip Diverter as described on page 9.
- ▶ Template guides are available with a variety of bushing diameters. Typically, the bushing diameter should be slightly larger than the router bit diameter, but never so close that the router bit can contact the interior of the bushing.

CAUTION: If the spinning router bit contacts the interior of the template guide, it will damage both the router bit and the guide.

- ▶ The routing pattern needs to be larger than the desired routed edge as shown in both images to the right.
- ▶ The offset (shown in both images to the right) between the pattern and the final routed edge is $\frac{1}{2}$ the difference between the template guide bushing diameter and the router bit diameter.

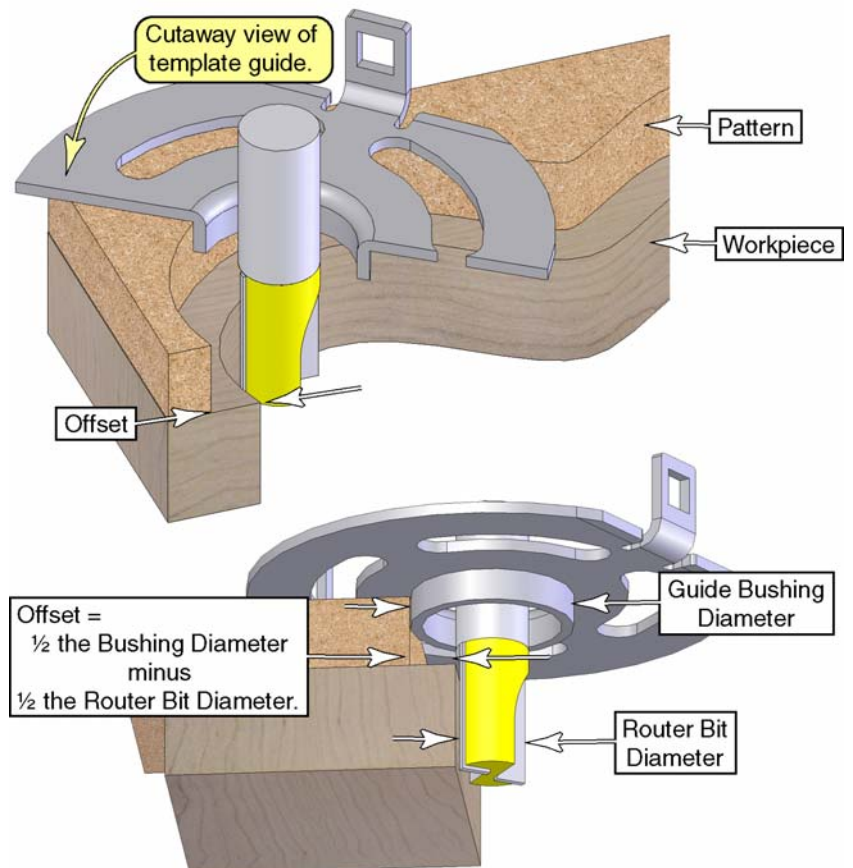

Systainer (System Container)

Every Festool product is shipped in its own unique system container, called a "Systainer". This provides protection and storage for the tool and accessories. All Systainers are stackable and can be interlocked together, including stacking and locking atop Festool dust extractors.



Parts of the Systainer

- ▶ **Carrying Handle.** The carrying handle folds flat when not in use.
- ▶ **Cover Latches.** The two green latches on the front of the Systainer secure the cover. (These are also used for stacking Systainers, as described below.)
- ▶ **Stacking Latches.** The two gray latches on the sides of the Systainer are used for stacking one or more systainers together.
- ▶ **Stacking Tabs.** The stacking tabs are used to lock two systainers together. There are four sets of tabs (two on the front and two on the sides) of each systainer.

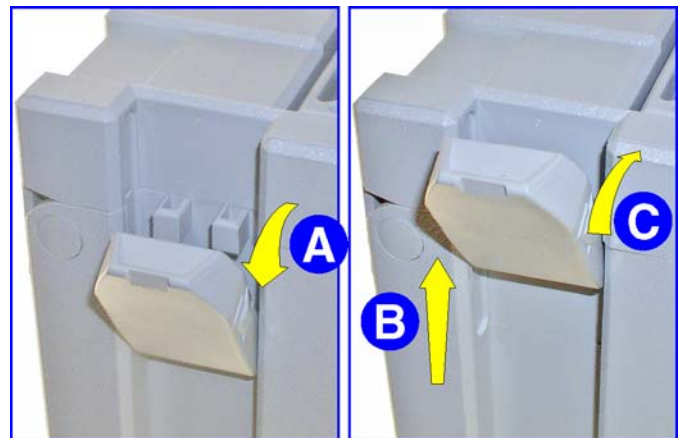

Stacking Systainers

For convenience in transporting Festool tools and accessories, the systainers can be stacked and locked together. The systainers are locked together using the stacking tabs and latches.

1. Place one systainer on top of the other.
2. Release all four latches on the lower systainer by pulling back at their top edges (step A to the right).
3. Slide all four latches upward (step B) as depicted by the two views.
4. Snap all four latches back to their flat position (step C) so they engage the stacking tabs of the upper systainer.

The lower image to the right shows two accessory systainers stacked together.



Troubleshooting

Symptom	Possible Causes
Motor does not start	<ul style="list-style-type: none"> ▶ Check that the cord is properly plugged into the router and into an outlet. ▶ Make sure the outlet has power. Check the circuit breaker or try another outlet. ▶ If used with a Festool dust extractor, make sure the selector switch is pointing to "Auto". The auxiliary outlet on the dust extractor has power only when the selector is at Auto. ▶ Inspect the power cord (including extension cords) for damage or missing prongs. ▶ The motor brushes may have worn and need replacement.
Router does not plunge smoothly	<ul style="list-style-type: none"> ▶ Make sure the plunge lock knob is loose. ▶ Clean the plunge posts (columns) and inspect for scratches and damage.
Router bits slip in the collet	<ul style="list-style-type: none"> ▶ The collet and mating arbor taper can become pitted from acids and oil in the wood. Clean the tapered surfaces: <ol style="list-style-type: none"> 1. Remove the collet from the router. 2. Using a plastic scrubbing pad, clean the outer taper of the collet. 3. Using a plastic scrubbing pad, clean the interior taper of the arbor. 4. Make sure there is no plastic or metal debris left over from the cleaning, and reinsert the collet. ▶ If router bits have spun inside the collet, it may be damaged and need replacement.
Routed profile burns	<ul style="list-style-type: none"> ▶ The router bit is dull. ▶ The router speed is too fast. ▶ The feed speed is too slow. ▶ Some materials are prone to burning. Take a shallow clean-up pass with a higher feed rate. ▶ If the burn is below the profile, then the router bit guide bearing (if present) is worn. <ul style="list-style-type: none"> ▶ Remove the bit from the router and spin the bearing with your finger. If the bearing spins roughly, it needs replacement. ▶ A good bearing should coast for about one revolution when spun with your finger. If it coasts more than one revolution, it is worn. ▶ Replace the bearing or bit.
Router vibrates excessively	<ul style="list-style-type: none"> ▶ If a large diameter router bit is slightly out of balance, it will vibrate at high speed. Reduce the router speed. If the vibration is severe, discard the router bit. ▶ The router bit shaft may be bent. Discard the bit if the shaft is bent. ▶ The router bearings may be worn and need replacement. Send the router in for service.

Maintenance

Routine Maintenance

Any maintenance or repair work that requires opening of the motor housing should be carried out only by an authorized Customer Service Center (whose name is supplied by your dealer)! Maintenance or repair work carried out by an unauthorized person can lead to improper connection of electrical wires or other components, which can result in injury.

To prevent injury or electrocution, always unplug the tool from the power supply outlet before performing any maintenance or repair work on the tool!

Do not use compressed air to clean the motor housing of the tool, as you could inject foreign objects into the motor through the ventilation openings. Compressed air may be used on other components, but personal safety protection should be employed (hearing, vision, and respiratory).

Certain cleaning agents and solvents are harmful to plastic parts. Some of these include, but are not limited to: Gasoline, Acetone, Methyl Ethyl Ketone (MEK), Carbonyl Chloride, cleaning solutions containing Chlorine, Ammonia, and household cleaners containing Ammonia.

To ensure proper cooling of the tool and motor, the cooling vents in the motor housing must always be kept clear and clean.

Keep the Tool Clean

Dust and debris from some materials can be extremely abrasive and cause components within the router to wear prematurely. It is important to keep moving parts cleared of abrasive dusts.

- ▶ As a general rule, keep the tool clean of all dust and debris. Even soft-wood dust can be abrasive over time.
- ▶ Examine all moving parts for dust and debris.
- ▶ Keep the plunge posts clean so dust does not get embedded into the bearing surfaces.

Keep the Router Bits Sharp

Using a dull router bit can be extremely dangerous and cause poor cut quality.

- ▶ Never attempt to sharpen a router bit manually. Special equipment is necessary to properly sharpen any rotating-type cutter. An improperly sharpened router bit can injure the operator, destroy the tool, and damage the workpiece.
- ▶ Your router bits should be sharpened regularly, and only by a qualified sharpening service.

Adjust and Inspect the Tool

To ensure the tool is in proper working order, periodically inspect the operation of the tool and ensure it is properly adjusted.

- ▶ Observe the function of the router during normal operation.
- ▶ Unusual sounds are indicative of pending problems.
- ▶ A reduction in the cut quality indicates the router bit is dull or the router is not functioning properly.
- ▶ A reduction in cutting power or speed may indicate a dull cutter or a motor problem.

Changing the Motor Brushes

The motor brushes wear out over time and need to be replaced by an authorized service center. Festool does not condone brush replacement by the end-user. Completion of this procedure by an unauthorized service center will void the tool's warranty.

Removal Procedure

 **CAUTION!** Make sure the power cord is unplugged before beginning this procedure.

1. Remove the four screws that secure the access cover to the motor, and remove the cover.
2. Remove the three screws that secure the upper cover to the main handle, and remove the cover.

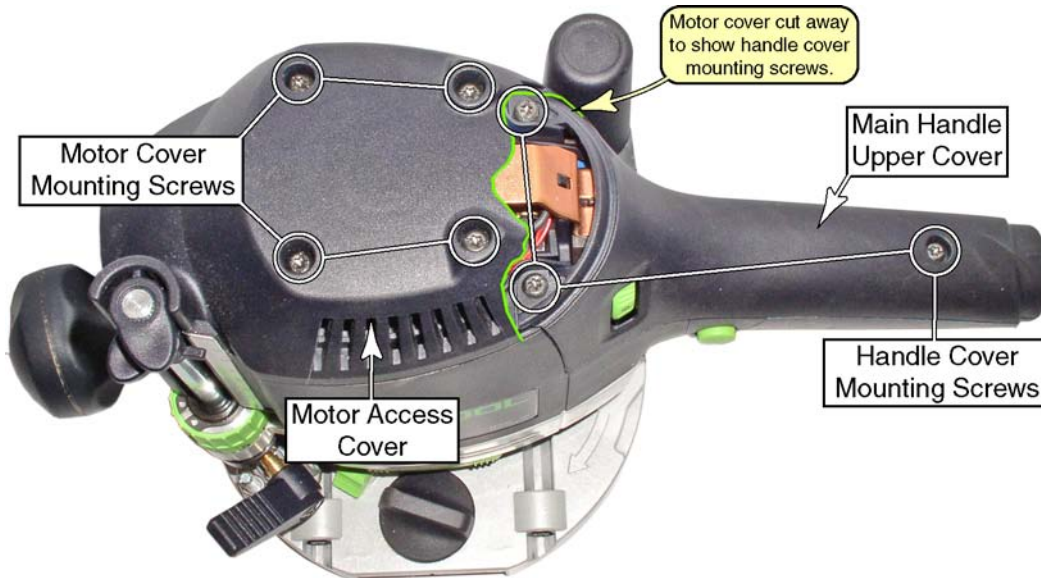

3. To access one of the two brushes, you will need to remove the electronics module.

- a. Make note where the wires are routed.
- b. Very carefully, lift up on the copper strap until it is free from the retaining tab.
- c. Slide the electronics module up, but do not remove it completely.

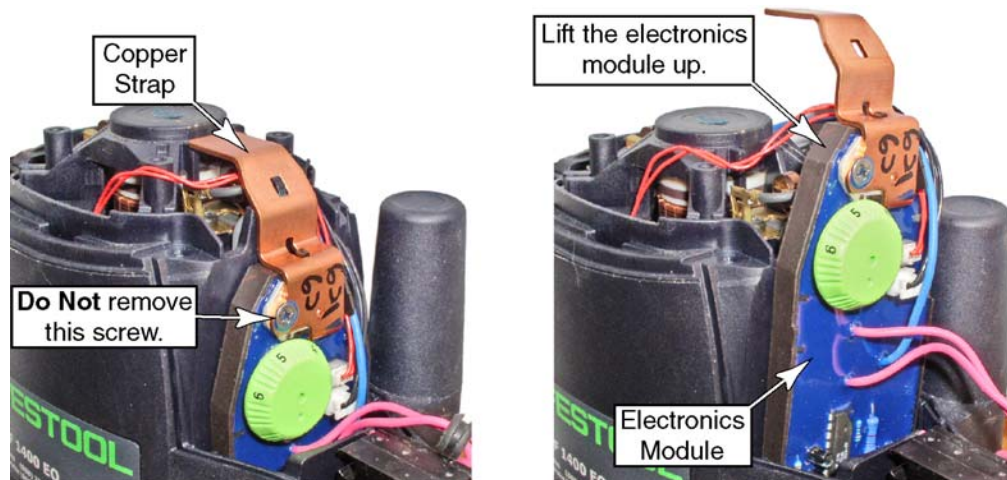

4. Lift the wire connectors off the terminals on the brushes.
5. Remove the screw that secures each brush to the motor housing. Be careful not to drop the screws into the motor.
6. Carefully lift the brushes straight up to remove them.

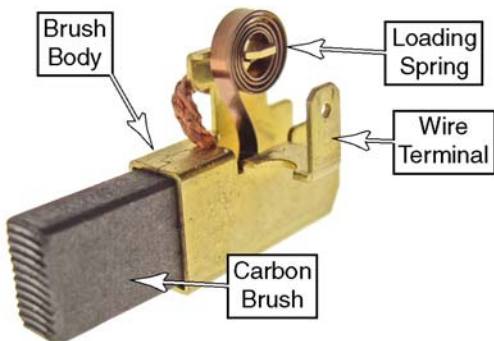
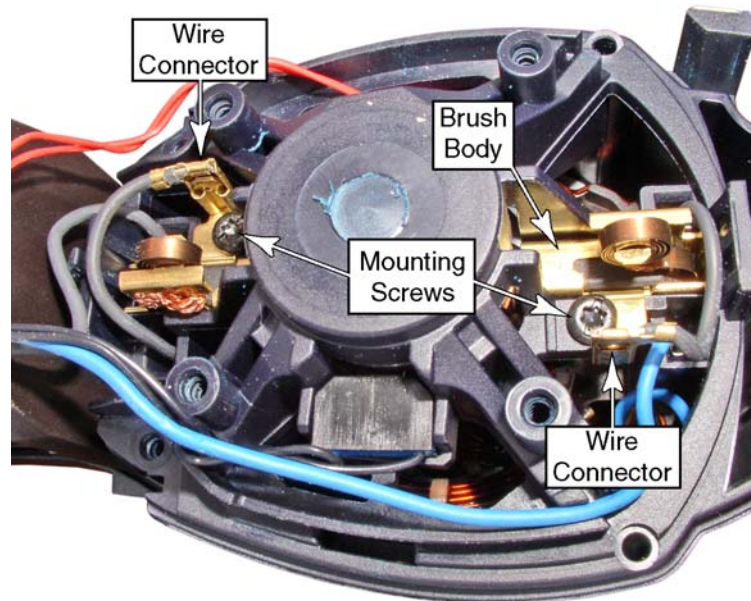

Replacement Procedure

1. Hold the carbon brush inside the brush body, and insert the brush into the mounting slot (as shown below).
2. Fully seat the brush into the slot.
3. Replace the two brush mounting screws.
4. Replace the two wire connectors to the terminals on the brushes.

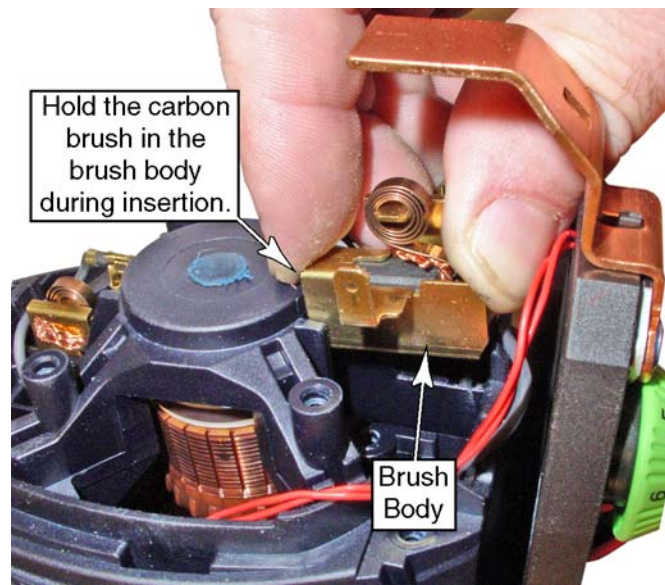

5. Press the electronics module back into the router.
 - ▶ Make sure the wires passing under the copper strap are not pinched by the strap.
 - ▶ Do not force the electronics into place. If the module does not press in freely, something must be in the way.
 - ▶ When fully inserted, the tab on the top of the motor housing will be flush with the top of the copper strap.

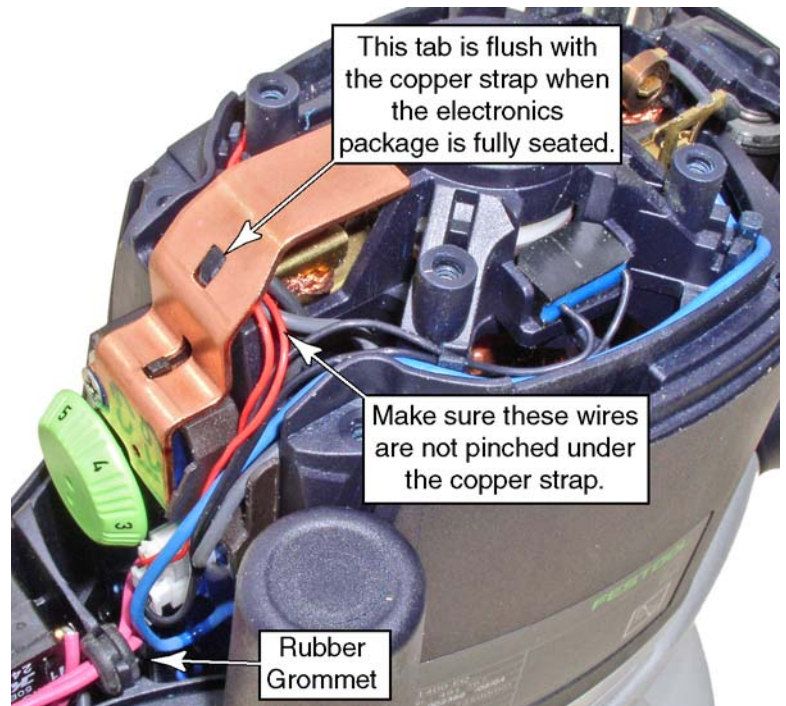

6. Carefully examine the wires. Make sure they are routed properly and will not be pinched when the covers are installed.
7. Reinstall the covers on the router.

i Note that during the break-in period while the new brushes conform to the shape of the armature contacts, the brushes may exhibit more arching (sparking) than normal.