

Owner's Manual

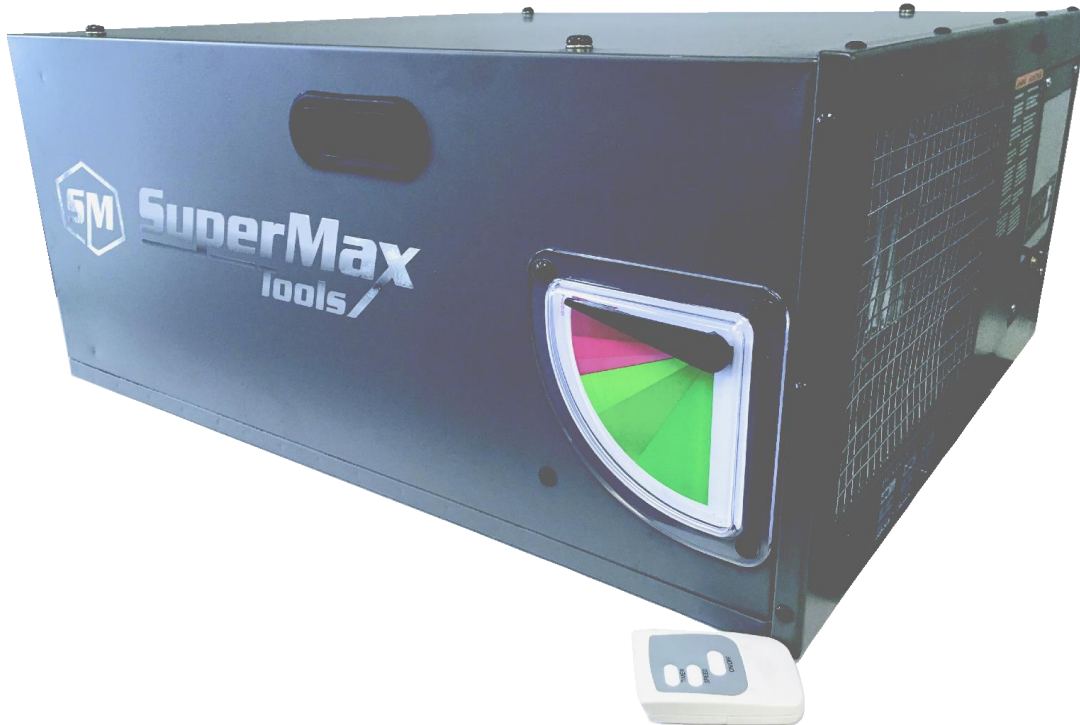

**3 Speed Ambient Air Cleaner
with Electrostatic Filter
Model 810650**



SuperMax
Tools

Operating Your 3 Speed Ambient Air Cleaner

To the new SuperMax owner:

SuperMax takes pride in our products and stands behind them with continuing service and support for our customers. Your SuperMax 3 Speed Ambient Air Cleaner was designed to bring a new dimension of productivity to your shop with air filtration.

This air cleaner is covered with a warranty and your dealer can answer any questions you may have. Additionally, we will always be here to offer support, service information, and product supplies and services.

Before using your air cleaner for the first time, learn how to use it. This manual covers a step-by-step process of assembly and machine operation. If you have any questions, this manual will provide answers and you can also refer to our website or customer service for any updates or further details.

SuperMax Team

Write your model and machine number in this manual for any questions or ordering information:

CONTACT INFORMATION FOR SUPERMAX

SuperMax Tools

1275 Corporate Center Drive
St. Paul, MN 55121

Phone: (651) 454-3401

Toll Free: (888) 454-3401

Fax: (651) 454-3465

sales@supermaxtools.com

www.supermaxtools.com

IDENTIFICATION INFORMATION

Model # 810650

Serial # _____

Purchase Date _____

Dealer Info _____

WARRANTY

The SuperMax 3 Speed Ambient Air Cleaner comes with a three-year limited warranty. We will provide replacement parts if found to be defective materially or in workmanship. Full warranty on page 15.

TABLE OF CONTENTS

IMPORTANT SAFETY INSTRUCTIONS	3	INSTALLATION OPTIONS.....	9
SAFETY GUIDELINES - DEFINITIONS	3	OPERATION	12
GENERAL SAFETY RULES	4	TROUBLESHOOTING	13
ADDITIONAL SPECIFIC SAFETY RULES	4	MAINTENANCE.....	13
FUNCTIONAL DESCRIPTION	6	SERVICE	15
CARTON CONTENTS	8	WARRANTY.....	15
UNPACKING AND CLEANING	9		

IMPORTANT SAFETY INSTRUCTIONS

▲WARNING: Read and understand all warnings and operation instructions before using any tool or equipment. Always follow basic safety precautions to reduce the risk of personal injury. Improper operation, maintenance or modification of tools or equipment could result in serious injury and property damage. There are certain applications for which tools and equipment are designed. This product should NOT be modified and/or used for any application other than for which it was designed.

If you have any questions relative to its application DO NOT use the product until you have written to us and we have advised you. Contact us online at www.supermaxtools.com or by mail at 1275 Corporate Center Drive, St. Paul, MN 55121. Information regarding the safe and proper operation of this tool is available from the following sources:

- Power Tool Institute, 1300 Sumner Ave, Cleveland, OH 44115-2851 or online at www.powertoolinstitute.com
 - National Safety Council, 1121 Spring Lake Drive, Itasca, IL 60143-3201
 - American National Standards Institute, 25 West 43rd St, 4 floor, New York, NY 10036
- www.ansi.org - ANSI 01.1

Safety Requirements for Woodworking Machines

- U.S. Department of Labor regulations www.osha.gov

SAFETY GUIDELINES-DEFINITIONS

It is important for you to read and understand this manual. The information it contains relates to protecting YOUR SAFETY and PREVENTING PROBLEMS. The symbols below are used to help you recognize this information.

▲DANGER: Indicates an imminently hazardous situation which, if not avoided, will result in death or serious injury.

▲WARNING: Indicates a potentially hazardous situation which, if not avoided, could result in death or serious injury.

▲CAUTION: Indicates a potentially hazardous situation which, if not avoided, may result in minor or moderate injury.

▲CAUTION: Used without the safety alert symbol indicates potentially hazardous situation which, if not avoided, may result in property damage.

GENERAL SAFETY RULES

▲ WARNING: Failure to follow these rules may result in serious personal injury.

FOR YOUR OWN SAFETY, read and understand the instruction manual before operating the unit. Learn the unit's application and limitations as well as the specific hazards peculiar to it. Keep work area clean. Cluttered areas and benches invite accidents. Don't use in a dangerous environment. Don't use this unit in damp or wet locations, or expose it to rain. Keep work area well-lighted. Keep out of reach of children and visitors. All children and visitors should be kept a safe distance from work area. Disconnect the unit before servicing. Check any damaged parts before further use of the unit, properly repair or replace any part that is damaged.

ADDITIONAL SPECIFIC SAFETY RULES

▲ WARNING: Failure to follow these rules may result in serious personal injury.

▲ WARNING: DO NOT USE THIS UNIT TO FILTER METAL DUST. Combining wood and metal dust can create an explosion or fire hazard.

▲ WARNING: This unit is intended to filter non explosive atmospheres only.

DO NOT USE THIS UNIT TO DISSIPATE FUMES OR SMOKE. Explosions or fire can result. This dust collector is intended for use where only dry airborne dust is present. Its use should be limited to non-explosive, non-metallic atmospheres.

1. DO NOT OPERATE THIS UNIT UNTIL IT IS COMPLETELY ASSEMBLED AND INSTALLED ACCORDING TO THE INSTRUCTIONS. A unit incorrectly assembled can cause injury.
2. OBTAIN ADVICE FROM YOUR SUPERVISOR, INSTRUCTOR, OR ANOTHER QUALIFIED PERSON if you are not thoroughly familiar with the operation of this unit. Knowledge is safety.
3. FOLLOW ALL WIRING CODES and recommended electrical connections to

prevent electrical shock or electrocution.

4. DO NOT PULL THIS UNIT BY THE POWER CORD.

Do not allow the power cord to come in contact with sharp instruments or edges, hot surfaces, or oil or grease. Do not place any weight on top of the power cord. A damaged power cord can cause electrical shock or electrocution.

5. SUPPORT THIS UNIT OR SECURELY CLAMP IT TO THE WORK SURFACE WHEN IT IS USED IN A PORTABLE APPLICATION to eliminate potential injury and/or damage from falling.
6. ENSURE THAT THE INTAKE AND EXHAUST AREAS ARE CLEAR PRIOR TO STARTING THE UNIT. Clogged intakes or exhausts can cause an explosion and/or fire.

8. KEEP ARMS, HANDS, AND FINGERS AWAY FROM THE FAN. Avoid all exposure to rotating parts to prevent injury.
9. DO NOT OPERATE THIS UNIT WITHOUT THE DUST FILTERS IN PLACE AND PROPERLY SECURED. Sawdust and other debris can provide the potential for fire and/or explosion and can also cause inhalation

problems.

10. MAINTAIN THE UNIT IN TOP CONDITION.

Clogged filters can increase the potential for fire or explosion. Follow all instructions for changing and cleaning filters.

11. STORE THIS UNIT IN A LOCATION that eliminates the potential for damage to the power cord. A damaged power cord can cause shock or electrocution. Safely store power cord on the unit to eliminate tripping

hazards.

12. TURN THE UNIT “OFF” AND DISCONNECT THE UNIT from the power source before installing or removing accessories, before adjusting or changing set-ups, or when making repairs. An accidental start- up can cause serious injury.

13. TURN THE UNIT “OFF”, disconnect the unit from the power source, and clean the table/work area before leaving the area.

SAVE THESE INSTRUCTIONS.

Refer to them often and use them to instruct others.

POWER CONNECTIONS

A separate electrical circuit should be used for your machines. This circuit should not be less than #12 wire and should be protected with a 15 Amp time lag fuse. If an extension cord is used, use only 3-wire extension cords which have 3-prong grounding type plugs and matching receptacle which will accept the machine's plug. Before connecting the machine to the power line, make sure the switch (s) is in the "OFF" position and be sure that the electric current is of the same characteristics as indicated on the machine. All line connections should make good contact. Running on low voltage will damage the machine.

▲ DANGER Do not expose the machine to rain or operate the machine in damp locations

MOTOR SPECIFICATIONS

Your machine is wired for 120V, 60 HZ alternating current. Before connecting the machine to the power source, make sure the switch is in the "OFF" position.

GROUNDING INSTRUCTIONS

▲ DANGER This machine must be grounded while in use to protect the operator from electric shock.

1. **All grounded, cord-connected machines:** In the event of a malfunction or breakdown, grounding provides a path of least resistance for electric current to reduce the risk of electric shock. This machine is equipped with an electric cord having an equipment-grounding conductor and a grounding plug. The plug must be plugged into a matching outlet that is properly installed and grounded in accordance with all local codes and ordinances.

Do not modify the plug provided - if it will not fit the outlet, have the proper outlet installed by a qualified electrician. Improper connection of the equipment-grounding conductor can result in risk of electric shock. The conductor with insulation having an outer surface that is green with or without yellow stripes is the equipment-grounding conductor. If repair or replacement of the electric cord or plug is necessary, do not connect the equipment-grounding conductor to a live terminal. Check with a qualified electrician or service personnel if the grounding instructions are not completely understood, or if in doubt as to whether the machine is properly grounded. Use only 3-wire extension cords that have 3-prong grounding type plugs and matching 3-conductor receptacles that accept the machine's plug, as shown in Fig. A. Repair or replace damaged or worn cord immediately.

2. **Grounded, cord-connected machines intended for use on a supply circuit having a nominal rating less than 150 volts:** If the machine is intended for use on a circuit that has an outlet that looks like the one illustrated in Fig. A, the machine will have a grounding plug that looks like the plug illustrated in Fig. A. A temporary adapter, which looks like the adapter illustrated in Fig. B, may be used to connect this plug to a matching 2-conductor receptacle as shown in Fig. B if a properly grounded outlet is not available. The temporary adapter should be used only until a properly grounded outlet can be installed by a qualified electrician. The green-colored rigid ear, lug, and the like, extending from the adapter is used, it must be held in a place with a metal screw.

NOTE: In Canada, the use of a temporary adapter is not permitted by the Canadian Electric Code.

⚠ DANGER In all cases, make certain that the receptacle in question is properly grounded. If you are not sure, have a qualified electrician check the receptacle.

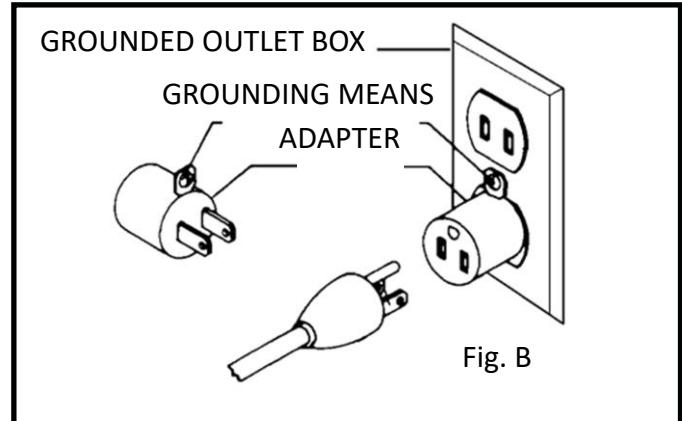
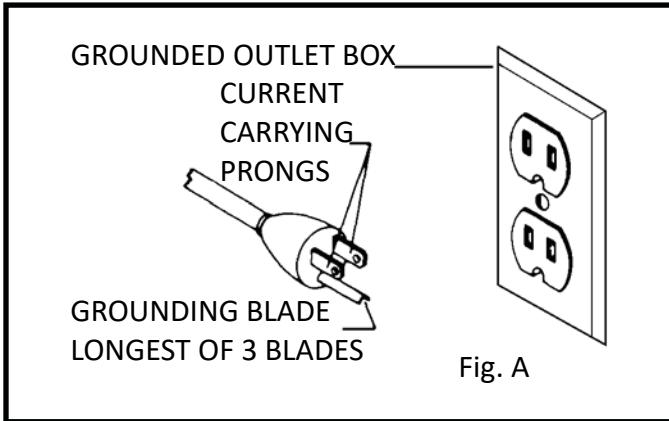

EXTENSION CORDS

⚠ WARNING Use proper extension cords. Make sure your extension cord is in good condition and is a 3-wire extension cord which has a 3-prong grounding type plug and matching receptacle which will accept the machine's plug. When using an extension cord, be sure to use one heavy enough to carry the current of the machine. An undersized cord will cause a drop in line voltage, resulting in loss of power and overheating. Fig. C, shows the correct gauge to use depending on the cord length. If in doubt, use the next heavier gauge. The smaller the gauge number, the heavier the cord.

MINIMUM GAUGE EXTENSION CORD RECOMMENDED SIZES FOR USE WITH STATIONARY ELECTRIC MACHINES			
Ampere Rating	Volts	Total Length of Cord in Feet	Gauge of Extension Cord
0-6	120	up to 25	18 AWG
0-6	120	25-50	16 AWG
0-6	120	50-100	16 AWG
0-6	120	100-150	14 AWG
6-10	120	up to 25	18 AWG
6-10	120	25-50	16 AWG
6-10	120	50-100	14 AWG
6-10	120	100-150	12 AWG
10-12	120	up to 25	16 AWG
10-12	120	25-50	16 AWG
10-12	120	50-100	14 AWG
10-12	120	100-150	12 AWG
12-16	120	up to 25	14 AWG
12-16	120	25-50	12 AWG
12-16	120	GREATER THAN 50 FEET NOT RECOMMENDED	

Fig. C

FUNCTIONAL DESCRIPTION

FOREWORD

3 Speed Ambient Air Cleaner with Electrostatic Filter is specifically designed to quietly circulate and filter non-metallic dust which is generated throughout the work area. The Air Cleaner is furnished with two filters: an outer filter which filters particles that are five microns and larger, and a secondary disposable filter that captures 91% of the dust particles that are one micron and larger (one micron = one millionth of a meter). Because breathing microscopic particles can be a potential health hazard, filtering microscopic dust particles offers a cleaner and safer environment. This Air Cleaner will filter the air in a room measuring 20' x 20' x 8' either 13, 16, or 18 times an hour, depending on the setting. If desired, multiple units can be used to filter larger areas. An occasional cleaning and/or replacement of filters is the only required maintenance.

CARTON CONTENTS



1

- 1) Air Cleaner
- 2) Remote Control
- 3) 2-AAA Batteries
- 4) Rubber Feet (4)
- 5) 1" Eye-Bolts (4)
- 6) 5/16" Flange Nuts (4)



2

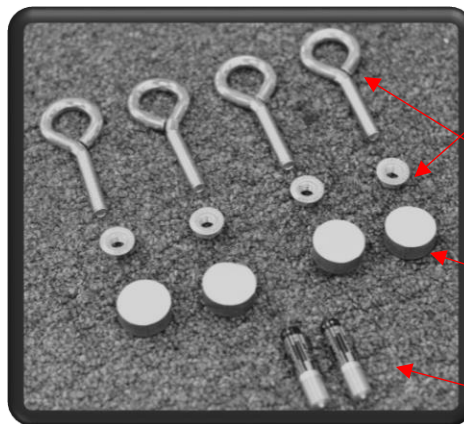

6

5

4

3

UNPACKING AND CLEANING

The Air Cleaner is shipped complete in one shipping container. Carefully unpack the Air Cleaner and all loose items from the shipping container.

Styrofoam blocks have been packed inside the unit for protection. REMOVE THESE BLOCKS (A) Fig. 2 prior to use. To Remove:

1. Disconnect unit from power source.
2. Remove outer filter by lifting up on the bottom and pulling out (Fig. 2A).
3. Remove inner filter by lifting up on the bottom and pulling out (Fig. 2B).
4. Remove Styrofoam blocks (A) Fig. 2C and replace filters.

⚠ WARNING DO NOT LIFT THE AIR CLEANER BY THE POWER CORD.



Fig. 2A



Fig. 2B



Fig. 2C

A

INSTALLATION OPTIONS

Determine whether the Air Cleaner will be used on the floor, on a bench, or hanging from an overhead support. If the Air Cleaner will be used as a mobile unit, proceed to **“USING THE AIR CLEANER ON A BENCH OR FLOOR SURFACE”** section. If the unit will be ceiling-mounted, proceed to section **“MOUNTING THE AIR CLEANER TO A CEILING OR OVERHEAD SUPPORT.”**

IMPORTANT: When determining where to mount the air cleaner, always select a location where the air flow is unrestricted. Do not locate the unit in a corner or near any heating or cooling vents.

USING THE AIR CLEANER ON A BENCH OR FLOOR SURFACE

Locate (4) self-adhesive rubber feet (A) Fig. 3 supplied with the unit. Carefully place the Air Cleaner on a firm supporting surface with access to the bottom of the cabinet. Apply a self-adhesive rubber foot (A) Fig. 3 to the bottom at each corner of the air cleaner cabinet. The rubber feet will help eliminate vibration and will prevent the possibility of the air cleaner “walking” across the floor or work surface.

⚠ WARNING For operator safety, clamp the unit to a work bench or position it securely on sawhorses.

The air cleaner cabinet has convenient lifting handles located on either side (one of which is shown at (A) Fig. 4). To avoid damage to the air filters, carry the air cleaner with the filters positioned away from your body.

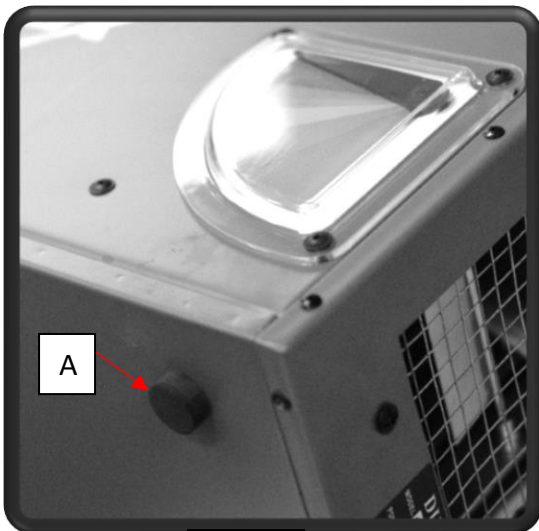

Fig. 3

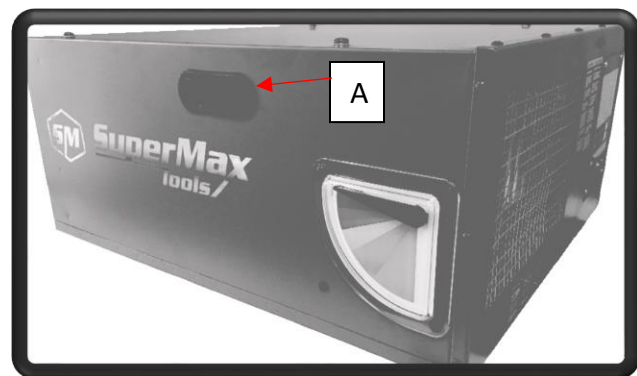

Fig. 4

MOUNTING AIR CLEANER TO THE CEILING OR OVERHEAD SUPPORT

⚠ WARNING This unit weighs approximately 60 pounds. When mounting overhead, be certain that the unit is securely fastened and supported.

1. Locate the four 1" eye bolts and the four 5/16" Flange nuts supplied with the unit.
2. Use a flat blade screwdriver (not supplied) to remove the four screws (C) Fig. 5 from the top of air cleaner (D).
3. Thread one flange nut on each bolt approximately 5/16".
4. Thread the eye-bolts (F) Fig. 6 into the four holes where the screws were removed in STEP 2.

NOTE: Be certain that the flange nuts are tightened against the surface of the air cleaner.

NOTE: When suspending the air cleaner from the ceiling or other overhead support, use steel s-hooks that are a minimum of 5/16".

NOTE: Thread all lag hooks at least 1-1/2" into the supporting structural members.

⚠ WARNING Never secure the air cleaner hardware to drywall, drop ceiling tile/frame, or other non-structural members.

⚠ CAUTION Keep a minimum of seven feet between bottom of air cleaner and the floor surface.

⚠ WARNING Do not use rope, cable or power cord to suspend the unit from the ceiling. Use chain rated for a minimum of a 150 lb. working load.

IMPORTANT: When determining a location to mount the unit, the air cleaner will operate more efficiently when the air flow is unrestricted. Do not locate the unit in a corner or near any heating or cooling vents.

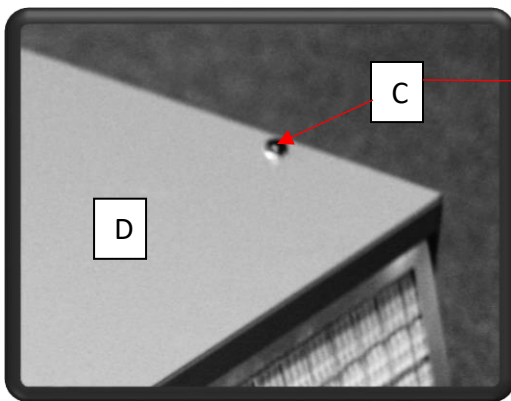

Fig. 5

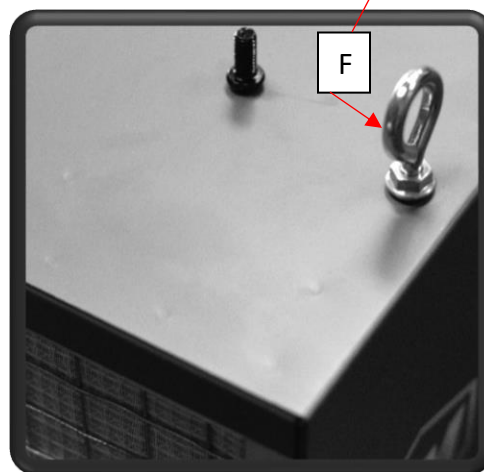
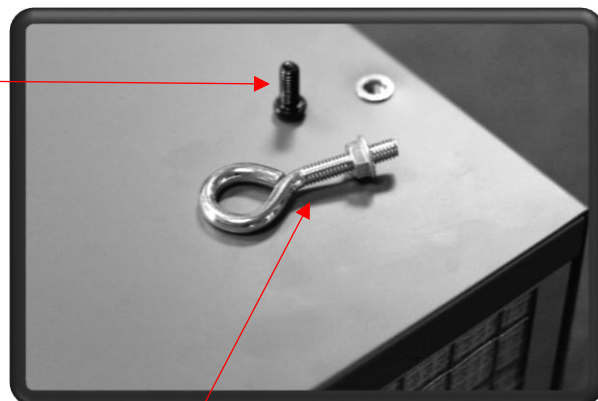
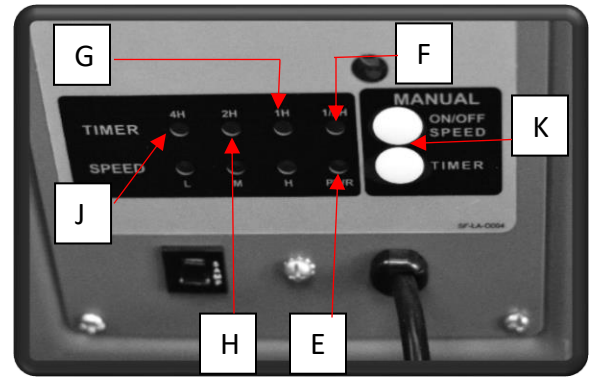

Fig. 6

USING THE REMOTE CONTROL

⚠ WARNING To reduce the risk of fire or electric shock, do not use this unit with any solid-state speed control device.



The remote control provided with this unit is not considered a solid-state device. The Air Cleaner is equipped with a REMOTE CONTROL (A) Fig.8A.

NOTE: The remote requires two (2) AAA batteries. The Battery housing is located underneath the back cover.

Notice that the remote control has three control button (Fig. 8A): TIME (B), ON/OFF (C), and SPEED (D). These buttons correspond to the LED sensor panel on the rear of the machine (K) Fig. 8B.

NOTE: When the machine is connected to the power source, a green light (E) will be activated on the panel.

To activate the blower unit, press the “ON/OFF” button (C) Fig. 8A. The machine will begin in the default speed of Low or “L” on the sensor panel. Press the SPEED button once, and the machine will run at the high (or “H” level). Press the SPEED button again, and the machine will run at the medium speed (or “M”). Press the SPEED button a third time, and the machine will return to the Low Speed mode. To turn the machine off, press the “ON/OFF” button (C) Fig. 8A. This unit has a timer that can be set by remote control. When the “TIME” button (B) Fig. 8A is pressed on the remote control, the machine will run for 1/2 hour. (An LED light will show up on the sensor panel (F) Fig. 8B). Pressing the “TIME” button again will set the machine to run for one hour. Notice that the light on the sensor panel has now moved to the 1H location (G) Fig. 8B. When the “TIME” button is pressed a third time, the machine will run for two hours. At this point, the green light will show up under the two hour location (H). When you press the “TIME” button the fourth time, the unit will run for four hours. Notice that the indicator light (J) glows at the four hour mark.

All of these functions can be manually controlled by using the two buttons on the sensor panel (K) Fig. 8B.

OPERATION

NOTE: The air cleaner may produce a slight odor for the first few hours of operation due to the protective coating which is applied to internal components. This odor will dissipate and should be disregarded.

IMPORTANT: Never operate the air cleaner without air filters in place.

The 3 Speed Ambient Air Cleaner with Electrostatic Filter can be used in

- a. Bench-top sanding applications.
- b. Circular saw applications.
- c. Dry wall applications.
- d. Shop cleaning applications.
- e. Floor sanding applications.
- f. Any other application where non-metallic dust is a factor.

TROUBLESHOOTING

For assistance with your machine, call us at (888) 454-3401.

MAINTENANCE

CHANGING AND CLEANING FILTERS

When cleaned as directed, your electrostatic air filter will give you many years of trouble-free use. Failure to properly clean the filter may lessen filter effectiveness, and as with any air filter, it is possible for an excessive dirt buildup to cause air flow resistance sufficient to damage other ventilation components. Depending on your specific situation the filter should be cleaned every 4-6 weeks. There is an “air flow” indicator (A) Fig. 9A located on the left side of the unit. To check the filters, turn the unit “ON”. If the indicator points to “green” (B) Fig. 9A, the filters are clean. Clean (or change) the filters when the indicator points to “red” (C) Fig. 9A as follows:



1. Turn the unit “OFF”.
2. Remove the outer first stage filter (A) Fig. 9B by lifting and pulling out on the bottom of the filter.
3. Rinse thoroughly to remove remaining dirt.
4. Drain excess water, let air dry, and reinstall.

⚠ WARNING Compressed air can be dangerous. For operator safety, do not

exceed an air pressure of 30 psi. Do not point the air nozzle toward yourself or anyone else. Always wear safety glasses and a dust mask when using compressed air.

3. Replace the filter, turn the unit "ON", and check the air flow indicator again.
4. If the air flow indicator points to "green", the inner filter is still useable. If the indicator points to "red", remove the outer filter, then remove the inner filter (B) Fig. 9C by lifting and pulling out on the bottom of the filter. DO NOT try to clean the inner filter. It is disposable and must be replaced.
5. After replacing the inner filter, reinstall the outer filter.

Cleaning of the inner 3 bag filter:

The 3 bag filter is very durable. The material is multiple layers synthetic microfiber. The synthetic microfiber builds up in non-woven layers to ensure multi-layers buildup and eliminate fiber shedding.

This bag filter is not washable. Clean it up by compressed air periodically or by vacuum light brush (recommended once per month). Then you can repeat to use it till it is clogged up by the dusts and the air flow is reduced obviously. Replacement 3 bag filters (P-610030301) are available from your retailer or from SuperMax Tools directly.



Fig. 9A

Fig. 9C



Fig. 9B



SERVICE

REPLACEMENT PARTS: Use only identical replacement parts.

To order parts, call the store you purchased it from or call our office at (888) 454-3401.

Replacement Parts List

P-6142422021	REMOTE CONTROL W/2 PCS AA BATTERY
P-603065326002	POWER CORD
P-6011110107001016120	MOTOR
P-2SF-C80-021	IMPELLER
P-2043154	PCB CONTROL BOARD (not including deco plate)
P-6020604102	5A RELAY
P-610030301	3 BAG FILTER
P-610040401	ELECTROSTATIC FILTER

WARRANTY

Keep your receipt of purchase to verify the warranty.

Three Year Limited New Product Warranty

We will repair or replace, at its expense and at its option, any new machine, machine part, or machine accessory which in normal use has proven to be defective in workmanship or material, provided that the customer returns the product prepaid to a factory service center or authorized service station with proof of purchase of the product within three (3) years and provides with reasonable opportunity to verify the alleged defect by inspection. For all refurbished product, the warranty period is 180 days. We will not be responsible for any asserted defect which has resulted from normal wear, misuse, abuse or repair or alteration made or specifically authorized by anyone other than an authorized service facility or representative. Under no circumstances will be liable for incidental or consequential damages resulting from defective products. Some states do not allow the exclusion or limitation of incidental or consequential damages, so the above limitation or exclusion may not apply to you. This warranty is sole warranty and sets forth the customer's exclusive remedy, with respect to defective products; all other warranties, express or implied, whether of merchantability, fitness for purpose, or otherwise, are expressly disclaimed by.