

Tool-less Blade Guide System Retrofit Kit

For RIKON 14" Bandsaws 10-324 & 10-325

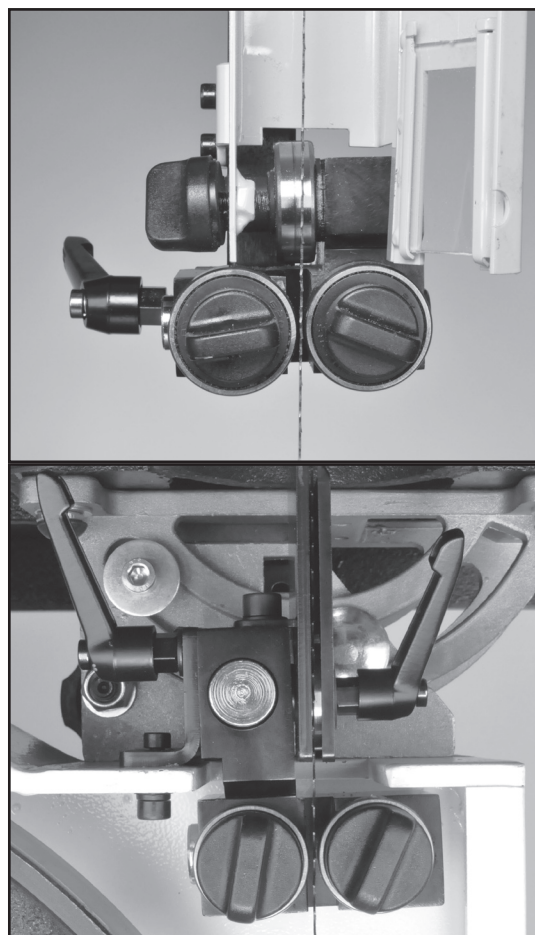

UPPER
GUIDE BEARING
ASSEMBLY

LOWER
GUIDE BEARING
ASSEMBLY

* PATENT PENDING

Installation & User Manual

Record the date of purchase in your manual for future reference.

Date of purchase: _____

For technical support or parts questions, email techsupport@rikontools.com or call toll free at (877)884-5167

TABLE OF CONTENTS

Safety Instructions	2
Contents of Package	2 & 3
Assembly	3 - 6
Adjustments.....	7 - 9
Maintenance	9
Parts Diagrams & Parts Lists	10 - 11

SAFETY INSTRUCTIONS

1. The machine must not be plugged in and the power switch must be in the OFF position until assembly is complete.
2. Do not install the Tool-less Blade Guide Retrofit System until you have read all of the instructions.
3. Installation of this Retrofit System must be done according to the following directions to correctly install the parts, and to insure that the future operation of the machine is proper and safe.
4. Any other bandsaw use not as specified, including further modification of the machine or use of parts not tested and approved by the equipment manufacturer, can cause unforeseen damage and invalidate the warranty.
5. Refer to your Bandsaw's Operation Manual for complete details on your bandsaw's Safety Instructions, Assembly, Adjustments and Operation.
6. If you are not familiar with the operation of the machine, obtain assistance from a qualified person.
7. Work in a clean, well lit area to keep tools and machine parts organized and safe.

SAVE THESE INSTRUCTIONS.

Store them with your Bandsaw's Operator's Manual for future reference.

CONTENTS OF PACKAGE

Unpacking and Checking Contents

1. Carefully remove all contents from the shipping carton. Compare the contents with the list of contents to make sure that all of the items are accounted for, before discarding any packing material. Place parts on a protected surface for easy identification and assembly.
2. If any parts are missing or broken, please call RIKON Customer Service (877- 884-5167) as soon as possible for replacements. DO NOT start assembling the Retrofit Kit onto your machine, or use the bandsaw if any of these items are missing. You may cause injury to yourself or damage to the machine.
3. Set packing material and shipping carton aside. Do not discard until the machine has been set up and is running properly, in case a product return is necessary.

NOTE: The specifications, photographs, drawings and information in this manual represent the current model when the manual was prepared. Changes and improvements may be made at any time, with no obligation on the part of RIKON Power Tools, Inc. to modify previously delivered units. Reasonable care has been taken to ensure that the information in this manual is correct, to provide you with the guidelines for the proper safety, assembly and operation of your machine.

NOTE: The 10-900 Retrofit Kit will not work with older RIKON bandsaws with serial numbers starting with TSAxxxx.

California Prop 65 WARNING: This product contains chemicals known to the State of California to cause cancer and birth defects or other reproductive harm. For more detailed information about California Proposition 65 log onto rikontools.com.

CONTENTS OF PACKAGE

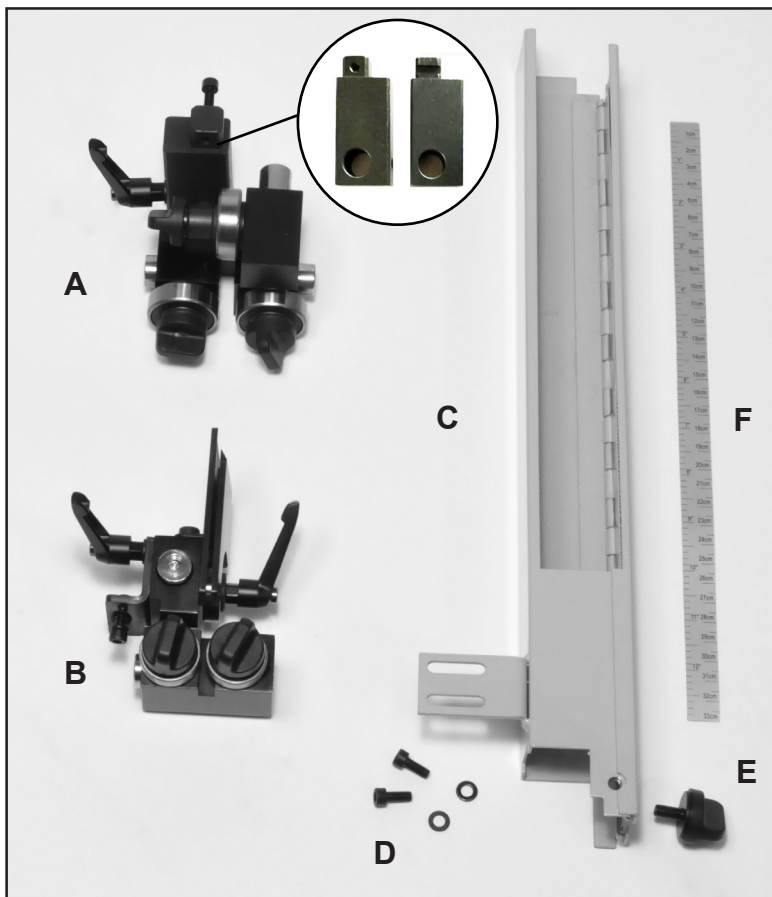

TABLE OF LOOSE PARTS

Tools and Tool Holder:

- A. Upper Blade Guide Assembly (w/2 Seats)
- B. Lower Blade Guide Assembly
- C. Upper Blade Guard
- D. Blade Guard Screws (2) & Washers (2)
- E. Knob for Blade Guard Door
- F. Scale for Blade Guard

Additional Tools Required - not supplied

- #2 Phillips Screwdriver
- 10mm Wrench or an Adjustable Wrench

NOTE: Parts referenced throughout the instructions refer to the key numbers of the Parts Diagrams and Parts Lists on pages 10 and 11.

ASSEMBLY



WARNING

THE MACHINE MUST NOT BE PLUGGED IN AND THE POWER SWITCH MUST BE IN THE OFF POSITION UNTIL ASSEMBLY IS COMPLETE.

REMOVE THE BANDSAW BLADE

1. Remove the bandsaw blade that is mounted on your machine. **NOTE:** Refer to your bandsaw's original Operator's Manual for instructions on the proper steps to safely perform this operation on your particular machine model.

INSTALLING THE UPPER BLADE GUIDES

Remove the original, upper blade guard that surrounds the blade above the table.

1. Lower the upper blade guides until they touch the table. This will give the best access to the blade guard, and make it easier to remove it from the saw frame.

2. Remove the blade guard from the guide post by unscrewing the two Hex Socket Cap Screws that hold it in place. Figure 1. Save these screws as they will be needed to install the new guard that is included with the Retrofit Kit.

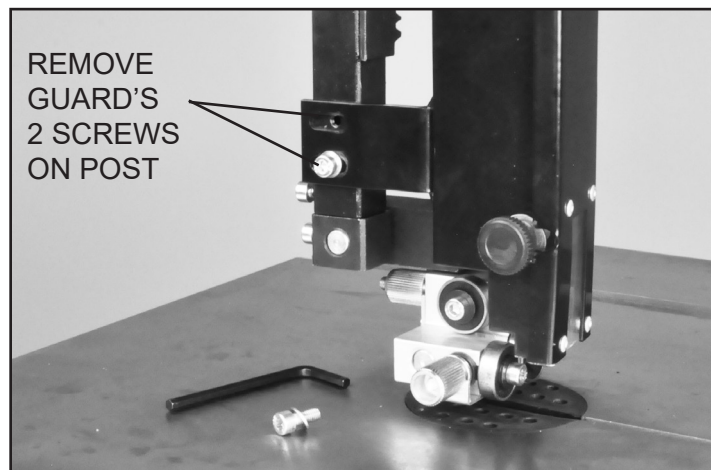

FIGURE 1

CONTINUED ON PAGE 4

ASSEMBLY

INSTALLING THE UPPER BLADE GUIDES - continued

3. Once the blade guard is unscrewed, remove the guard from the saw frame. This original guard will not be used with the new tool-less blade guides in the Kit.

Remove the original, ball bearing blade guides that were supplied on your machine.

4. Raise the guide post up above the table about 4 inches.

5. Remove the rear, Hex Socket Cap Screw that holds the upper blade guide assembly to the guide post. Figure 2, A. Save this screw as it will be used to install the new Tool-less Guide Assembly to the guide post.

6. Remove the originally supplied blade guide assembly from the guide post.

Install the new, Tool-less Blade Guide Assembly.

7. Insert the new assembly's guide block Seat (see NOTE 1) into the guide post. The fit of the Seat in the post should be tight. Slide the Bar of the Upper Guide assembly into the Seat and secure with the Locking Knob.

NOTE 1: 10-900 kit comes with two Seats (parts #19 & 19A). Part #19 Seat with Slot is for model 10-325. Part #19A Seat with Threaded Hole is for model 10-324 (and older 10-325). Take note of the original Seat from your saw and choose accordingly.

NOTE 2: The inside cavity of the post may have metal burrs left over from the original boring and threading operations. These may require filing off in order to install the new guide block seat into the interior of the guide post. The use of small metal files, like needle files, are recommended for removing any burrs. Filing of the guide block seat may also be necessary if the seat is a bit larger than the post interior. If the guide block seat is loose in the post interior, add thin shims (metal or hard plastic) around the seat to make the fit tight.

8. Fasten the new Blade Guide Assembly to the guide post with the same screw (A) removed in step 5. Fig. 3A.

Install the new upper Blade Guard.

9. Lower the blade guides down to the table.

10. Install the new Blade Guard that is supplied with the kit, onto the guide post. Use the screws that were removed in step 2, page 3, or use the new screws. Do not fully tighten the screws at this time. Figure 3B, B.

11. Install the locking Knob (part #4) on the side of the Guard Door. Figure 3B, C.

12. Before final tightening of the screws, make sure that the blade guard is positioned parallel, in-line with the blade guide post. Also make sure that it will not come in contact with the upper wheel and the door when it is closed. Close the upper door and raise & lower the guide post a few times to insure that the blade guard will not rub against these saw parts.

13. When positioned correctly, tighten the screws to secure the blade guard to the guide post. Figure 3B.

! WARNING THE MACHINE MUST NOT BE PLUGGED IN AND THE POWER SWITCH MUST BE IN THE OFF POSITION UNTIL ALL ADJUSTMENTS ARE COMPLETE.

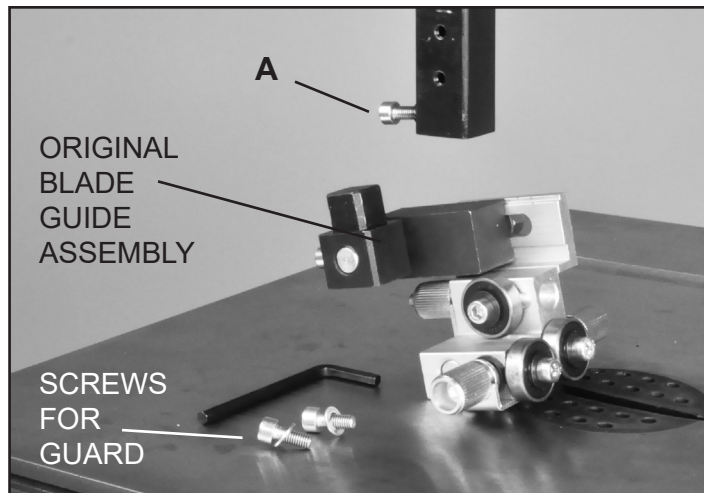
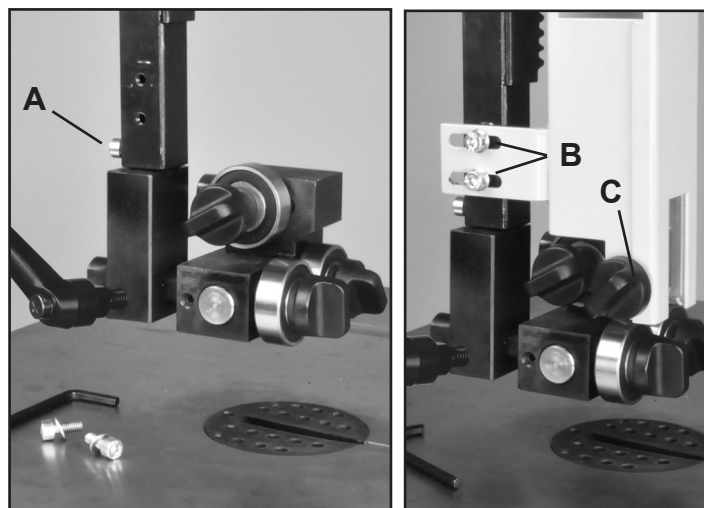

FIGURE 2



A

FIGURE 3

B

! WARNING Never operate the bandsaw without the blade guards in place, as serious injury may result.

ASSEMBLY

INSTALLING THE LOWER BLADE GUIDES

Remove the lower drive wheel from the machine.

1. Loosen the drive belt tension and remove the drive belt from the lower wheel's rear pulley step.
2. Remove the center Bolt and Washer that secure the lower wheel to the motor's drive shaft.
3. Remove the lower wheel from the drive shaft. **NOTE:** This operation will give better access to the lower frame interior, to allow the following installation steps to be easier.

Remove the original, lower blade guides and blade guard that are below the saw's table.

4. If necessary, consult your bandsaw's original Operator's Manual for information on the parts of the lower guide assembly, and to identify the fasteners needed to be accessed to remove the guide assembly from the lower saw frame.
5. With the old, lower blade guide and guard assembly removed, make sure that the lower frame area and pre-bored hole(s) is clean of any sawdust or residue left from past saw usage. Figure 4.

Install the new, lower Tool-less Blade Guide & Guard Assembly.

6. The new Blade Guide Assembly comes pre-assembled and ready for installing onto your machine. Remove the Hex Socket Cap Screw and Washers that are located under the Connecting Plate (part #26).

7. Position the Guide Assembly onto the lower frame with the small alignment pin/screw, that is on the bottom of the connecting plate, set into the pre-bored hole in the frame. Figures 4, 4A and 5.

NOTE: On older models of the 10-325 Bandsaws, the pre-bored mounting hole in the frame (Figure 4) may not be an oval shape to accept both connecting Hex Socket Cap Screw and Alignment Pin that are on the underside of the Retrofit Guide's Connecting Plate. If this is the case, the new lower Tool-less Guides cannot be assembled onto the frame. To solve this, there are 2 options (Option A is recommended):

- A. Remove the rear Alignment Pin/Screw. When removed, make sure that the bottom of the plate is smooth/flat where the pin was located.
- B. With a metal twist drill, rotary burr or round file, enlarge the mounting hole to accept both the screw and pin. Make sure that any metal burrs from the process are removed from the frame. Figure 4.

8. Once the lower Guide Assembly is positioned on the frame, insert the Cap Screw, with Washers removed in step 6, up through the hole in the saw frame and back into its threaded hole in the connecting plate. Do not fully tighten the screw at this time. Figure 5, Page 6.

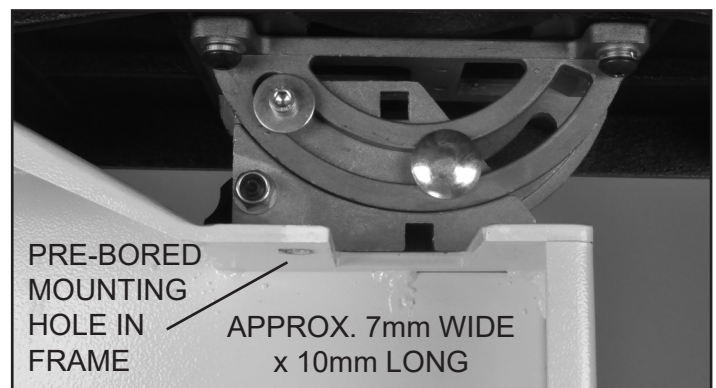

FIGURE 4

WARNING THE MACHINE MUST NOT BE PLUGGED IN AND THE POWER SWITCH MUST BE IN THE OFF POSITION UNTIL ALL ADJUSTMENTS ARE COMPLETE.

WARNING NEVER OPERATE THE BANDSAW WITHOUT THE BLADE GUARDS IN PLACE, AS SERIOUS INJURY MAY RESULT.

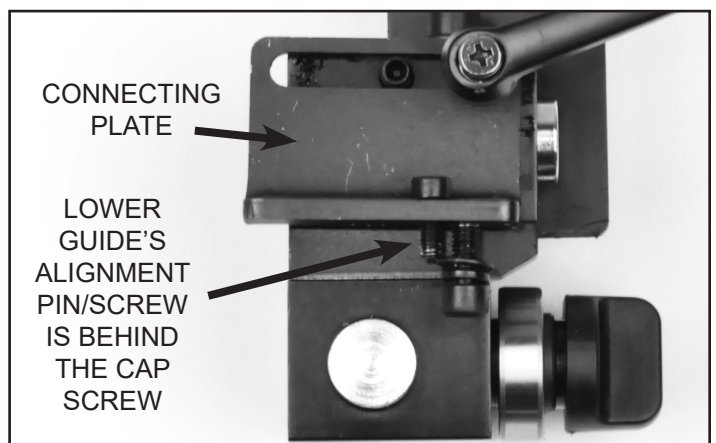

FIGURE 4A

CONTINUED ON PAGE 6

ASSEMBLY

INSTALLING THE LOWER BLADE GUIDES - continued

9. Make sure that the lower Guide Assembly is properly aligned straight to the frame, the saw's trunnion and with the bandsaw blade centered in the guard. Then tighten the Cap Screw to secure the assembly in place.

NOTE: If the lower, plastic blade guard hits the underside of the table insert, the guide assembly should be removed and the top of the guard can be carefully cut off ONLY about 3/8" - 5/8" inches (10-16mm) with a hack saw. DO NOT remove more than this from the top of the guard as this will defeat the safety purpose and regulations for the guard, and void the warranty. ALSO, see the note on page 8, below step #4 regarding the position of the guard to the rear thrust bearing.

Install the Lower Drive Wheel, Belt and Blade.

10. Reverse steps 1 to 3 above. Install the lower drive wheel and drive belt onto the machine, then re-tension the drive belt. Refer to your saw's Owner's Manual for instructions on setting drive belt onto the proper pulley step for the blade speed desired.

11. Install the bandsaw blade back onto the machine. Make sure that the top and bottom guides do not come in contact with the saw blade. Adjust the saw blade so that it tracks on the center of the wheels.

NOTE: Consult your saw's Operators Manual for instructions on setting proper belt tension and blade tracking.

12. Once the bandsaw blade is installed, the top and bottom guide bearings can be adjusted.

INSTALLING THE GUIDE HEIGHT SCALE

The Tool-less Blade Guide System Kit includes a measuring scale that can be applied to the right side of the upper blade guard for quick setting of the upper blade guides for the thickness of material to be cut.

To apply the scale to the blade guard:

1. Lower the upper blade guides down until they rest on the bandsaw table surface.
2. The scale should be positioned to the right side of the metal blade guard with the top of the scale in line with the underside of the frame. This is the beginning "0" location. The scale markings should increase as you read down the scale. Figure 6.
3. Remove the backing and attach the adhesive backed scale to the blade guard.
4. As the blade guides are raised, their distance up from the table can be read on the scale. So if 2" thick wood is to be cut, you can use the scale to quickly raise the blade guard assembly and set the upper blade guides to 2-1/4" for this material

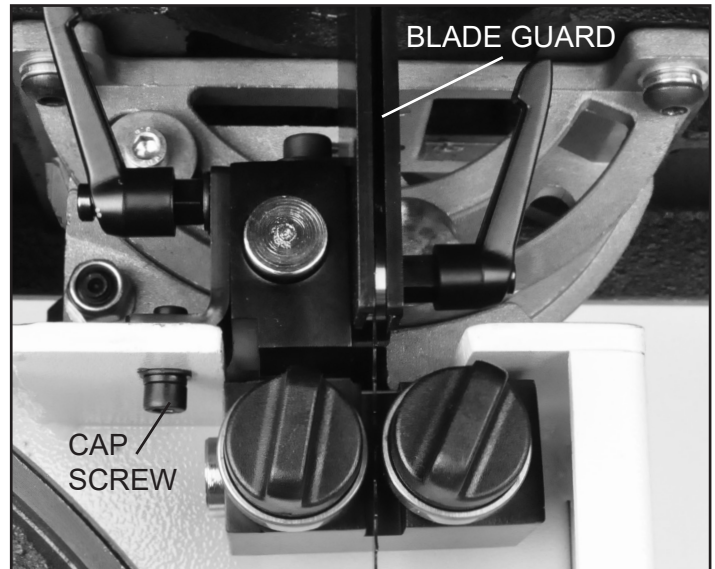

FIGURE 5

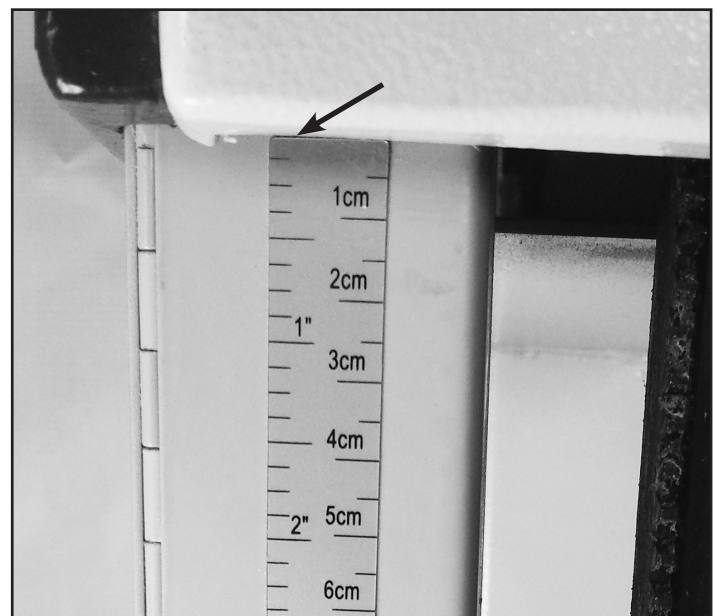

FIGURE 6

ADJUSTMENTS

ADJUSTING THE BLADE GUIDES

The *Tool-less Blade Guide System* features quick-adjusting, spring loaded, ball bearing blade guides for fast and easy setting to the blades. With the bandsaw blade properly centered on the drive wheels, the guide bearings can then be set. **NOTE:** The following photos are representative of the Tool-less Guide System and may not specifically match your machine.

Upper Guides:

1. Position the right and left roller guides relatively close to the blade. First, loosen their front Lock Handles (Fig. 7, A). The Guide Shafts that hold the guide bearings are spring loaded! To move the guides towards the blade, simply push the ends of the guide shafts (B), or use the front lock handles to pull the guides towards the blade. Lock the guides in place. Figure 7.

2. The guides should be approximately 1/16" behind the gullets of the saw blade. If they need to be moved, loosen the back Clamp Handle (Fig. 8, C) and move the Upper Guide Block (D) that holds the guides so that the guides are properly positioned behind the blade gullets. Re-tighten the handle when done. Figure 8.

3. Set both bearing guides to within 1/32" of the saw blade - about the same thickness of a business card. Do not set the bearing guides too close, or touch the sides of the blade, as this will adversely affect the life of the saw blade and bearings.

4. Adjust the rear bearing guide (Fig. 9, E) to be just clear of the back of the saw blade. Release the guide's Locking Handle (F) and move the rear guide towards the blade by pushing the end of the Rear Guide Shaft (G). Tighten the handle when done. Fig. 9

Lower Guides:

Adjusting the lower ball bearing guides, that are below the table, is similar to the steps for the upper guides.

1. Position the right and left roller guides close to the blade. Loosen the front Lock Handles (Fig. 10, A). Move the guides towards the blade by pushing the ends of the Guide Shafts (B), or use the front lock handles to pull the guides towards the blade. Lock the guides in place. Figure 10.



FIGURE 7

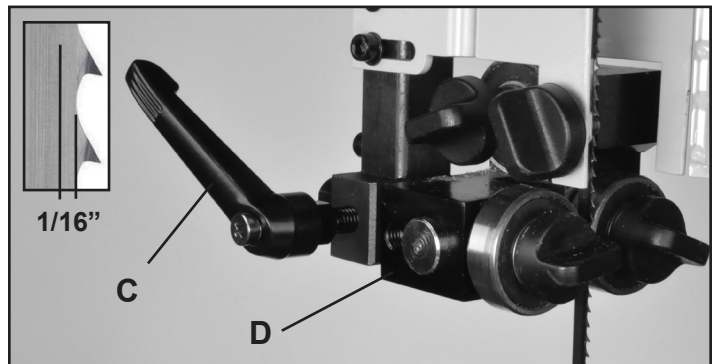

FIGURE 8

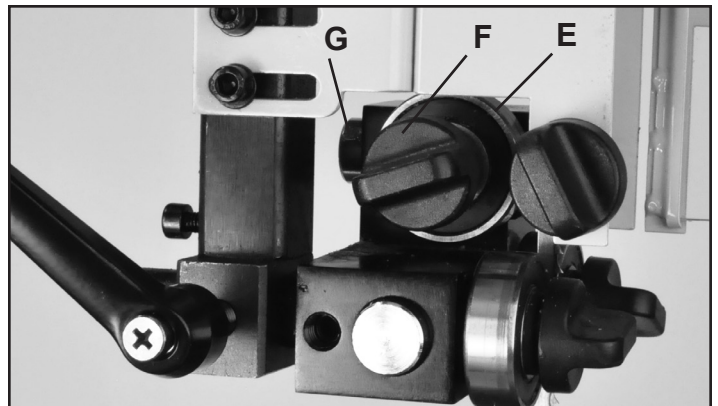

FIGURE 9

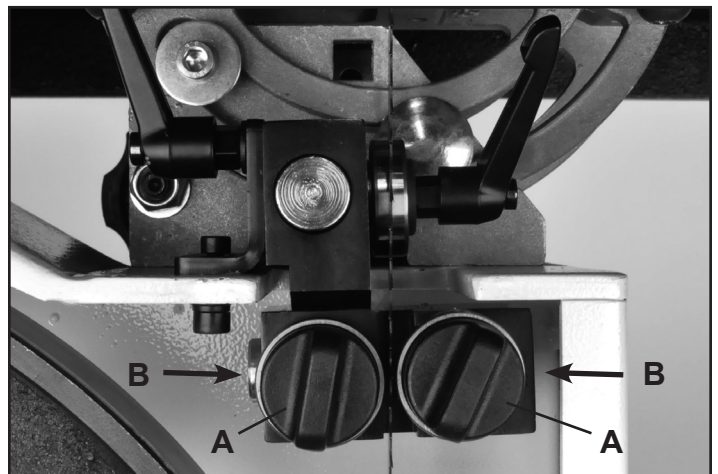

FIGURE 10

NOTE: Blade Guard removed for photo purposes

CONTINUED ON PAGE 8

ADJUSTMENTS

Adjusting the Lower Guides - continued:

2. The guides should be approximately 1/16" behind the gullets of the saw blade. If they need to be moved, loosen the Lever Handle (Fig. 11, A), located to the left of the Lower Guide Block (B), and move this block that holds the guides so that the guides are properly positioned behind the blade gullets. Re-tighten the lever handle when done.

3. Set both bearing guides to within 1/32" of the saw blade - about the same thickness of a business card. Do not set the bearing guides too close, or touch the sides of the blade, as this will adversely affect the life of the saw blade and bearings.

4. Adjust the rear bearing guide to be just clear of the back of the saw blade. Release the guide's Locking Handle (Fig. 12, C) and move the rear guide towards the blade by using the lock handle to pull the guide towards the blade. Tighten the handle when done.

NOTE: Due to manufacturing tolerances in the different bandsaw machine frames, the lower blade guard might come into contact with the face of the rear thrust bearing guide and prevent the bearing from being set in a fully forward position. If this occurs, remove the guard from the lower guide block (part #34) and elongate the guard's fastening hole about 5mm (3/16") towards the guard's rear edge. This should be careful done with a utility knife, 6mm (1/4") split point drill bit, or rotary burr. Once the hole is elongated, then re-attach the guard in place.

WARNING Never operate the bandsaw without the blade guards in place, as serious injury may result.

ADJUSTING THE BLADE GUIDE & GUARD

NOTE: Before cutting, set the upper guide bearings approximately 1/4" above the top surface of the work piece. This will give the best blade control. Figure 13.

1. Loosen the Guidepost Lock Knob (Fig. 14A) and turn the Guidepost Handle (Fig. 15, B) to raise or lower the guide post/upper blade guide assembly to the desired height.

Use the measurement scale on the right side of the guide post for quick reference on the height of the guide bearings above the table surface.

CONTINUED ON PAGE 9

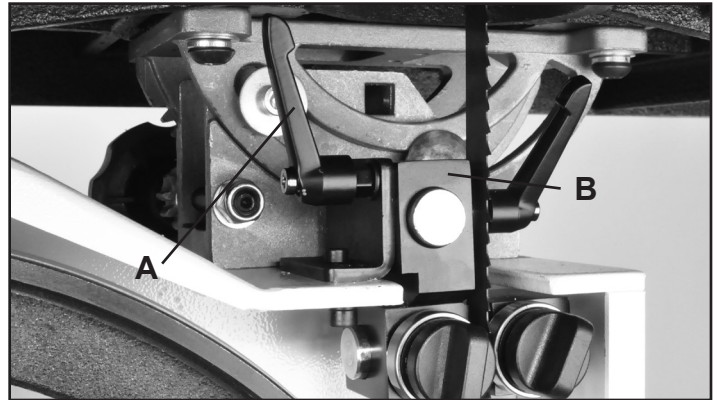

FIGURE 11 NOTE: Blade Guard removed for photo purposes

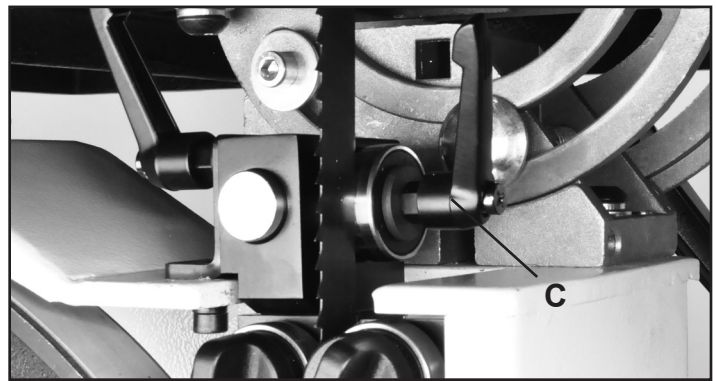

FIGURE 12 NOTE: Blade Guard removed for photo purposes

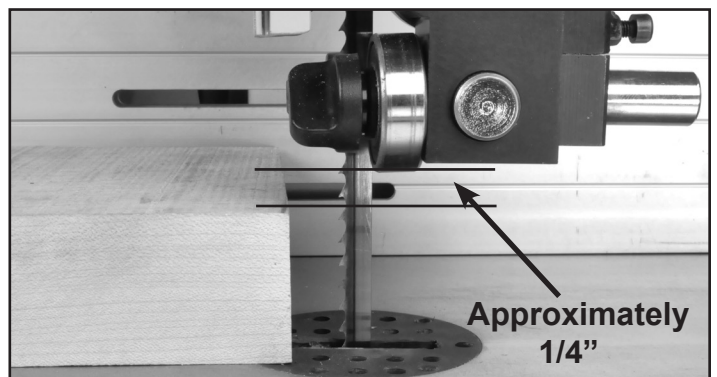

FIGURE 13

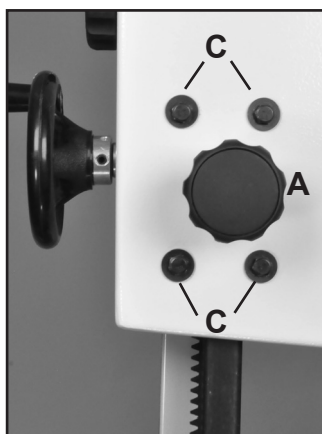

FIGURE 14

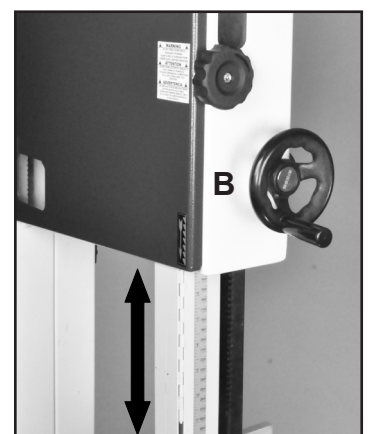

FIGURE 15

ADJUSTMENTS

ADJUSTING THE BLADE GUARD - continued

2. When the guide bearings are in proper position, re-tighten the guidepost lock knob.

NOTE: The guide post is pre-set at the factory to aligned vertical with the bandsaw blade. If the guide post setting ever needs slight adjustment:

3. Open the top door and lower the blade guard all the way down to the table to access the Guide Bracket. Figure 15, D.

4. Loosen the four Hex Bolts located at the rear of the top frame. Fig. 14, C). This will allow the guide post to be shifted/angled a bit left or right to correct any positioning issues.

5. There are also four Set Screws set in the rear of the guide bracket near the corners. If the guide post needs to be angled slightly towards the front or back of the table, or even twisted on an angle, make the adjustment with these screws. Figure 15.

- Advancing the top two set screws will angle the post towards the rear of the table.
- Advancing the bottom two set screws will angle the post towards the front of the table.
- Setting the two left or right screws will angle the post to the right or left.

6. When the post is adjusted vertical, tighten the four hex bolts that were loosened in step 4.

WARNING THE MACHINE MUST NOT BE PLUGGED IN AND THE POWER SWITCH MUST BE IN THE OFF POSITION UNTIL ALL ADJUSTMENTS ARE COMPLETE.

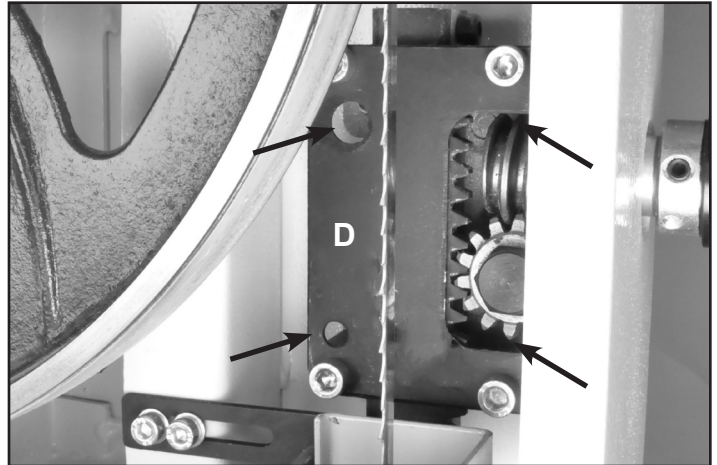

FIGURE 15

MAINTENANCE

CAUTION BEFORE CLEANING OR CARRYING OUT MAINTENANCE WORK, DISCONNECT THE MACHINE FROM THE POWER SOURCE (WALL SOCKET). NEVER USE WATER OR OTHER LIQUIDS TO CLEAN THE MACHINE. USE A BENCH BRUSH. DO NOT USE COMPRESSED AIR NEAR BEARINGS. REGULAR MAINTENANCE OF THE MACHINE WILL PREVENT UNNECESSARY PROBLEMS.

1. Before each use:

- Check the power cord and plug for any wear or damage. Periodically, check the drive belt for tension and wear.
- Check for any loose screws or hardware.
- Check the area to make sure it is clear of any misplaced tools, lumber, cleaning supplies, etc. that could hamper the safe operation of the machine.

2. To avoid a build-up of wood dust, regularly clean all parts of the machine using a soft cloth, brush or compressed air. A general cleaning should be done after every use to avoid future problems and ensure the machine is in ready condition for the next time it is used. Use dust collection, if possible.

3. The ball bearing blade guides are pre-lubricated, sealed, and do not need any further care. However, keep the guide bearings free of dust, and clean the guide bearing assemblies frequently.

4. Keep the ventilation slots of the motor clean to prevent it from overheating.

5. To prolong the life of the blade, when the bandsaw is not in use for extended periods, release the blade tension. Before reusing the bandsaw, ensure that the blade is re-tensioned and tracking is checked.

WARNING: If blowing sawdust, wear proper eye protection to prevent debris from blowing into eyes.

PARTS DIAGRAM

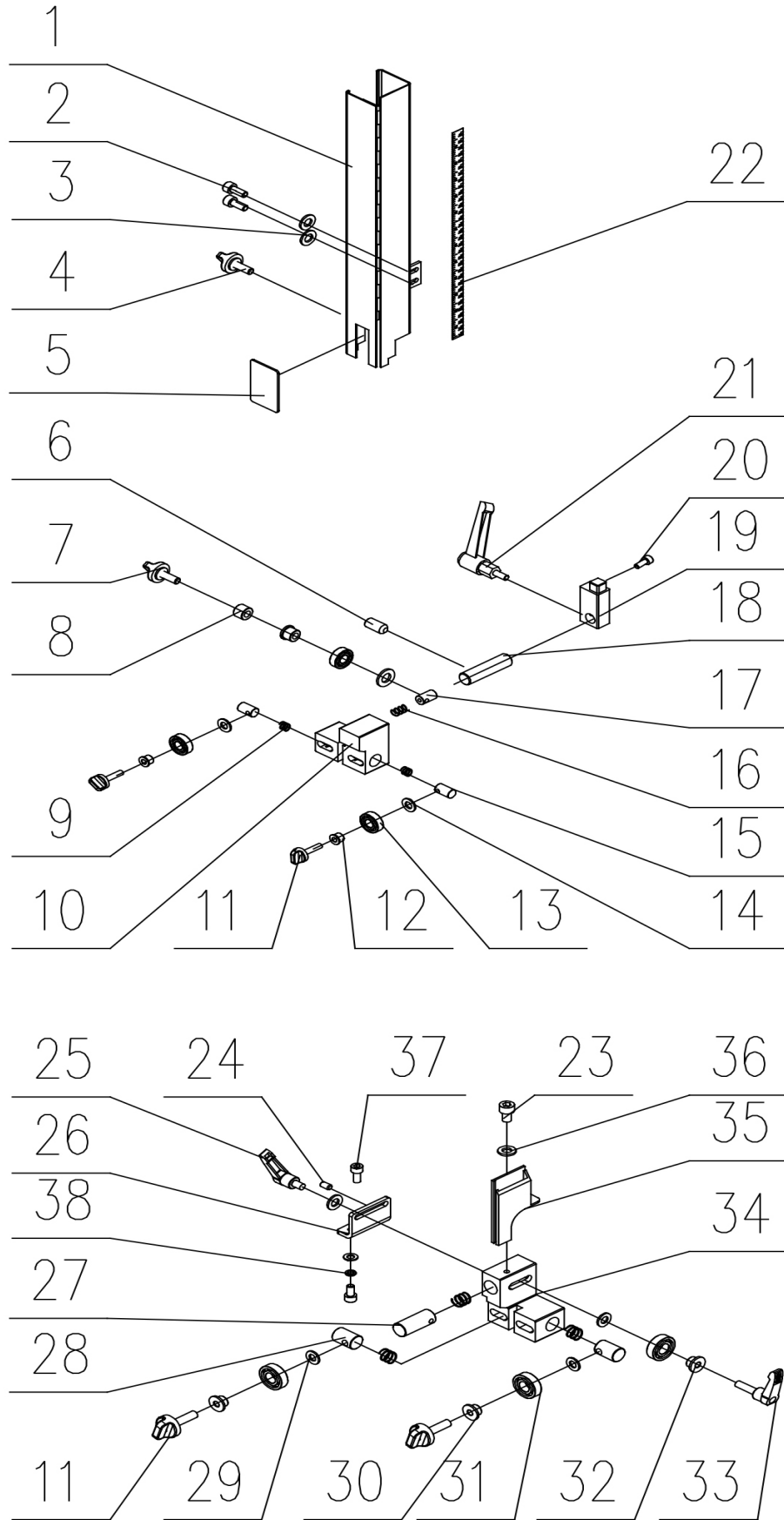

PARTS LIST

KEY NO.	DESCRIPTION	QTY.	PART NO.
1	Blade guard	1	1-JMBS1404051000-114X
2	Hex socket cap screw M5X12	3	1-M5X12GB70D1B
3	Flat washer	3	1-WSH5GB97D1B
4	Locking handle	1	1-JMBS1403050004-001S
5	Window	1	1-JMBS1404050001
6	Allen flat end set screws M8X10	3	1-M8X10GB77B
7	Long locking handle	1	1-JMBS1801052002-001S
8	Spacer	1	1-JMBS1403014007
9	Spring	5	1-JMBS1403014005
10	Upper guide	1	1-JMBS1401051001
11	Locking handle	4	1-JMBS1403014006-001S
12	Tube	3	1-JMBS1403014002
13	Bearing	3	1-BRG6202-2RSGB276
14	Big washer	3	1-WSH8GB96D1B
15	Guide shaft	2	1-JMBS1403014003
16	Spring	1	1-JMBS1403014008
17	Rear guide shaft	1	1-JMBS1403014004
18	Bar	1	1-JMBS1401051002
19	Seat with Slot (for Model 10-325)	1	1-JMBS1404050003A
19A	Seat with Threaded Hole (for Model 10-324)	1	1- JMBS1404050003
20	Hex socket cap screw M5X25	1	1-M5X25GB70D1B
21	Ratchet handle	1	1-KTSB-1-B-M8X63X20
22	Scale	1	JMBS1401050003
23	Hex socket cap screw M6X10	1	1-M6X10GB70D1B
24	Set screw	1	1-M6X10GB77B
25	Adjusting handle	1	1-KTSB-1-B-M6X50X10
26	Connecting plate	1	1-JMBS1404010003
27	Upper guide shaft	1	1-JMBS1404013003
28	Guide shaft	2	1-JMBS1404013002
29	Flat washer	3	1-WSH8GB97D1B
30	Tube	2	1-JMBS1404013004
31	Bearing	3	1-BRG6001-2RSGB276
32	Tube	1	1-JMBS1404013005
33	Adjusting handle	1	1-KTSB-1-B-M6X50X25
34	Lower guide	1	1-JMBS1404013001
35	Guard	1	1-JMBS1404010004-001S
36	Flat washer	2	1-WSH6GB97D1B
37	Hex socket cap screw M4X10	1	1-M4X10GB70D1B
38	Spring washer	1	1-WSH5GB93B

NOTE: Please reference the Manufacturer's Part Number when calling for Replacement Parts.
For Parts under Warranty, the Serial Number of your machine is required.



10-900

Tool-less Blade Guide System Retrofit Kit

For RIKON 14" Bandsaws 10-324 & 10-325

For more information:
16 Progress Road
Billerica, MA 01821

877-884-5167 / 978-528-5380
techsupport@rikontools.com

* PATENT PENDING

