

ADVANCED PHOTONICS

ADVANCED TACTICAL NIGHT VISION GOGGLES PVS-7

GSCI-PVS-7 is the MIL-SPEC, “single-tube, dual-eye” Night Vision Goggle system with enhanced functionality compared to the conventional PVS-7 unit. Designed for army, law enforcement, search & rescue professionals, it is the preferred choice for conducting critical ground-based and maritime operations during night time.

Using the best coated optics to enhance night time performance as well as the top-grade I2 tubes the PVS-7 from GSCI outperforms all other night vision goggles available on the professional market today.

ADVANTAGES OF THE PVS-7

PVS-Style Bayonet Interface

Manual Gain Control Option (MGC)

Optional External Power Port

Powered with 2 AA Batteries

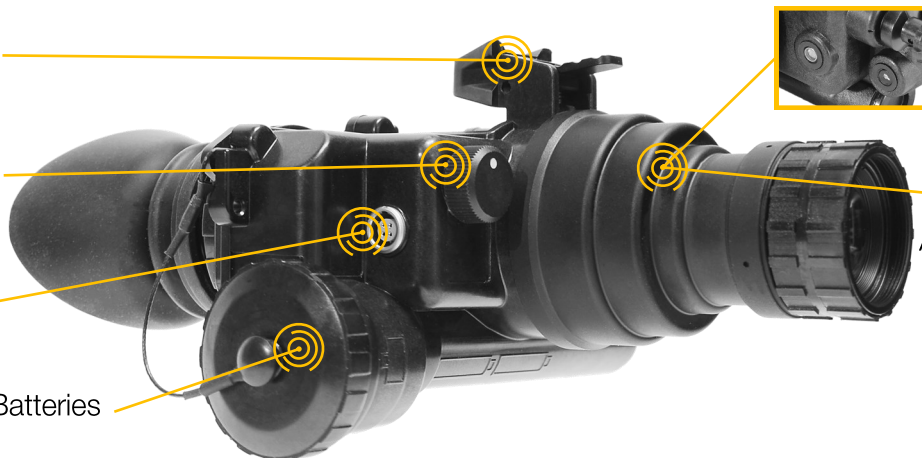

Built-In IR Illuminator,
& 850 nm
Automatic Light Overload
Shut-Off System

KEY FEATURES

- ◆ Universal Night Operations Tool
- ◆ Dual-Eye Observation
- ◆ High Situational Awareness
- ◆ Optional Manual Gain Control
- ◆ Optional External Power Port
- ◆ Optional Stow Safety Feature



Designed, Developed, Manufactured by GSCI Advanced Photonics

120 WHITMORE ROAD, UNIT 20, WOODBRIDGE, ONTARIO, L4L6A5, CANADA

WWW.GSCI.NET | GSCI@GSCI.NET | +1.905.850.0990

DISCLAIMER: Technical description, certain optical-electronic-mechanical features of the product shown herein and/or some of its parts/components may not precisely represent the actual device and are subject to change without prior notice by the sole discretion of General Starlight Company, Inc. Mass of the product represents measurable weight of all components this product consists of, such as optics, mechanics, and electronics. Dimensions of the product represents measurable size of the body, including all optical components attached and in fully folded position. Dimensions of additions such as mounting brackets, eyecups, objective lens covers, and/or battery extensions may vary and therefore are not listed herein. Copyright © 1992-2022 General Starlight Co., Inc. Canada. All rights reserved.

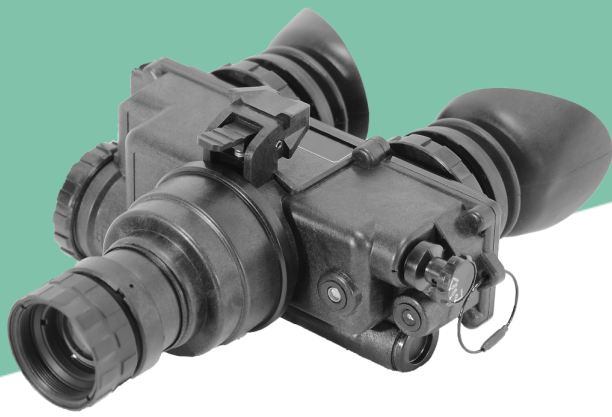

ADVANCED PHOTONICS

ADVANCED TACTICAL NIGHT VISION GOGGLES PVS-7

TECHNICAL DATA

Optical Magnification	1X
Objective Lens Focal Length	27mm
Focusing Range	0.25m .. Infinity
Diopter Adjustment Range	-4 .. +4
Built-In IR Illuminator	Yes, 850nm
IR-On LED Indicator	Yes, Concealed into FOV
Interpupillary Adjustment Range	53mm .. 72mm
Automatic Light Overload Shut-Off	Yes, Built-In
Bright Source Protection	Yes
Low Battery LED Indicator	Yes, Concealed into FOV
3-Position Switch	Yes: Off / On / IR
Stow Safety Feature (SSF)	Optional
Automatic Flip-Up-Off Feature	Yes
Automatic Brightness Control	Yes
Power Source	2pcs AA Batteries *
External Power Port	Optional: Accepts 4VDC .. 15VDC
Manual Gain Control	Optional
Battery Life on 2pcs AA	Up to 40 Hours
Operating Temperature	-40°C .. +50°C
Warranty	7 Years, Limited
Made In Canada	ITAR-Free

* Batteries not included

IMAGE INTENSIFIER TUBES

GEN 2+

GEN 3

‡ ECHO

‡ 4G

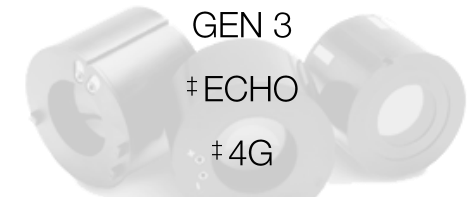

Autogating and White Phosphor options are available with selected tubes. Contact us for more details.

PHOTONIS

‡ ECHO and 4G are the registered trademarks of Photonis Technologies S.A.S.



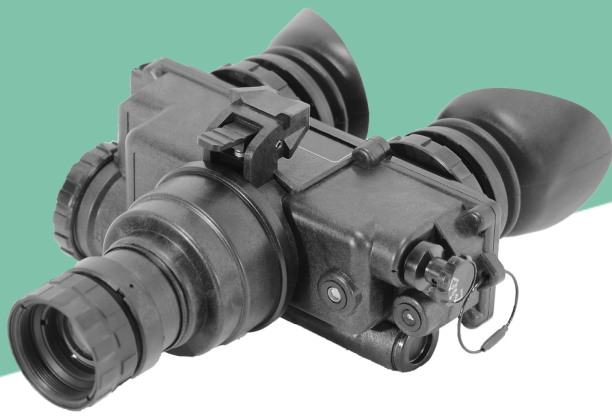

ADVANCED PHOTONICS

ADVANCED TACTICAL NIGHT VISION GOGGLES

PVS-7

DISTINCTIVE FEATURES



Flip-Up Off Feature

When Mounted on a Flip-Up Head Gear* or a Helmet Mount*, PVS-7 Turns Off Once in Flip-Up Position.

**Flip-Up Feature works only with purposely designed helmet mounts.*



Extended Range Observation (Optional)

The PVS-7 allows to attach additional 3X and 5X and even 7X objective lenses onto existing 1X optics to increase detection, recognition and identification ranges.

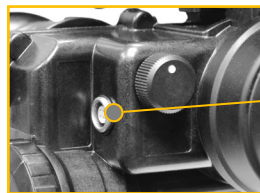

External Power Port (Optional)

The External Power Port is designed to power the unit from variety of external power sources.

Manual Gain Control (Optional)

Allows an operator to set image gain / intensity to a desired level based on ambient light conditions.
**pending IIT availability*

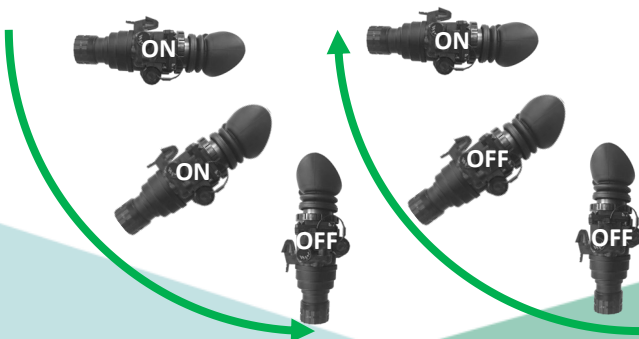
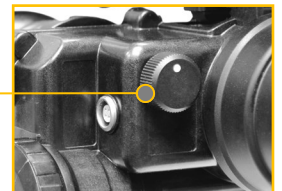

Stow Safety Feature (Optional)

When enabled, the SSF Feature Shuts Off the Unit once it is Stowed and Powers the Unit Back Up when it is Returned Back to the Horizontal Position. The SSF Feature Helps Stay Covert in Night-Time Operations.

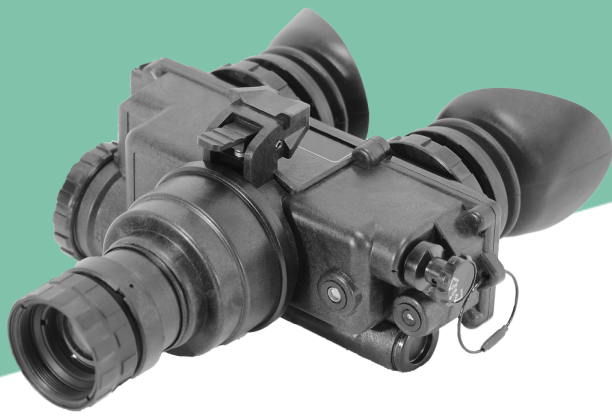

ADVANCED PHOTONICS

ADVANCED TACTICAL
NIGHT VISION GOGGLES

PVS-7

STANDARD EQUIPMENT: WHAT'S IN THE BOX

1	Night Vision Goggles
2	Rubber Eyecups (2 Installed on the device) + 2 Spare
3	Demist Shield (2pcs)
4	Sacrificial Window
5	Stow Safety Feature (<i>Integrated</i>)
6	Non-Flip-Up Head Gear PHG-7
7	Rubber Daytime Filter with Training Hole (<i>Installed on the device</i>)
8	Neck Cord
9	Soft Carrying Pouch
10	User Manual
11	Waterproof Hard Case
12	7-Year Warranty with Activation Form
13	Cleaning Kit (3-in-1 Multi-Pen + Soft Cleaning Cloth)

OPTIONAL EQUIPMENT

A	Advanced Helmet Harness HMH-1 for MICH / ACH Helmets
B	3X Magnification Afocal Add-On Objective Lens SL-3: Snap-On or Screw-In
C	5X Magnification Afocal Add-On Objective Lens SL-5: Snap-On or Screw-In
D	Manual Gain Control (MGC)
E	Stow Safety Feature
F	External Power Port, USB Power Cable included
G	Universal Multi-Voltage Battery Pack MVP-240 (for models with external power port only)
H	External Digital HD Recorder with Built-In Display and Video Output NVR-714-D
I	Tactical Infrared Illuminator IR-250S. Kit Includes IR-250S (850nm), Remote Control, Picatinny Mount