

LUMINA

Installation manual

Dimensions:
120x180 cm
150x180 cm
150x200 cm

Handedness:
Left



Leave space for better assembly

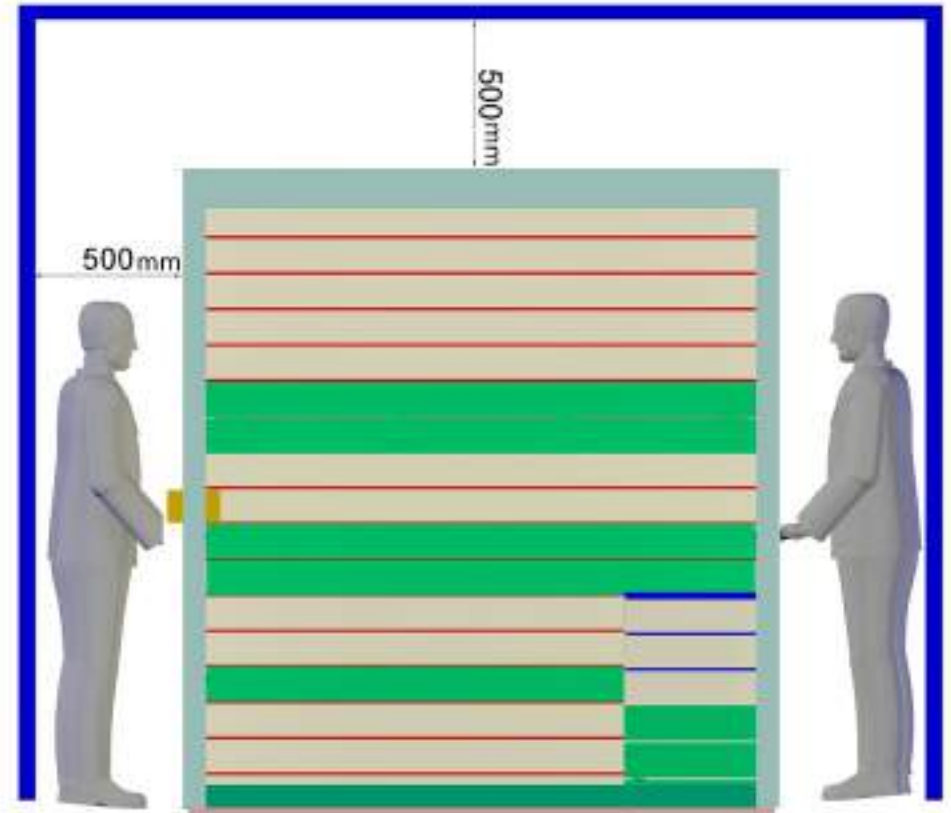
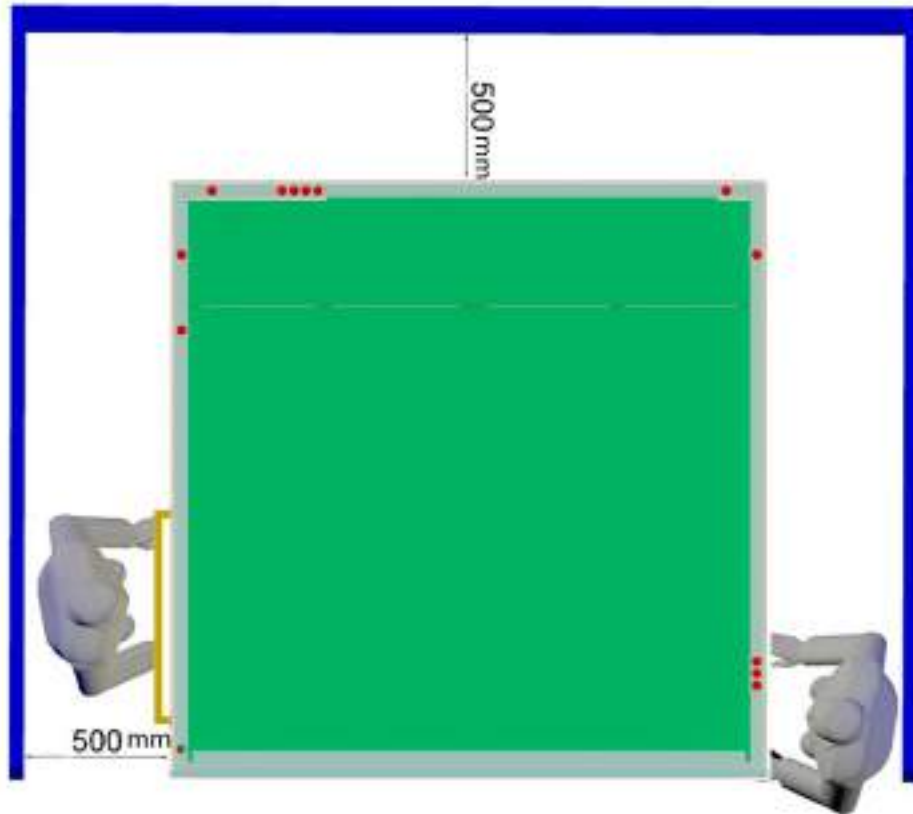

Tools



1. Base frame

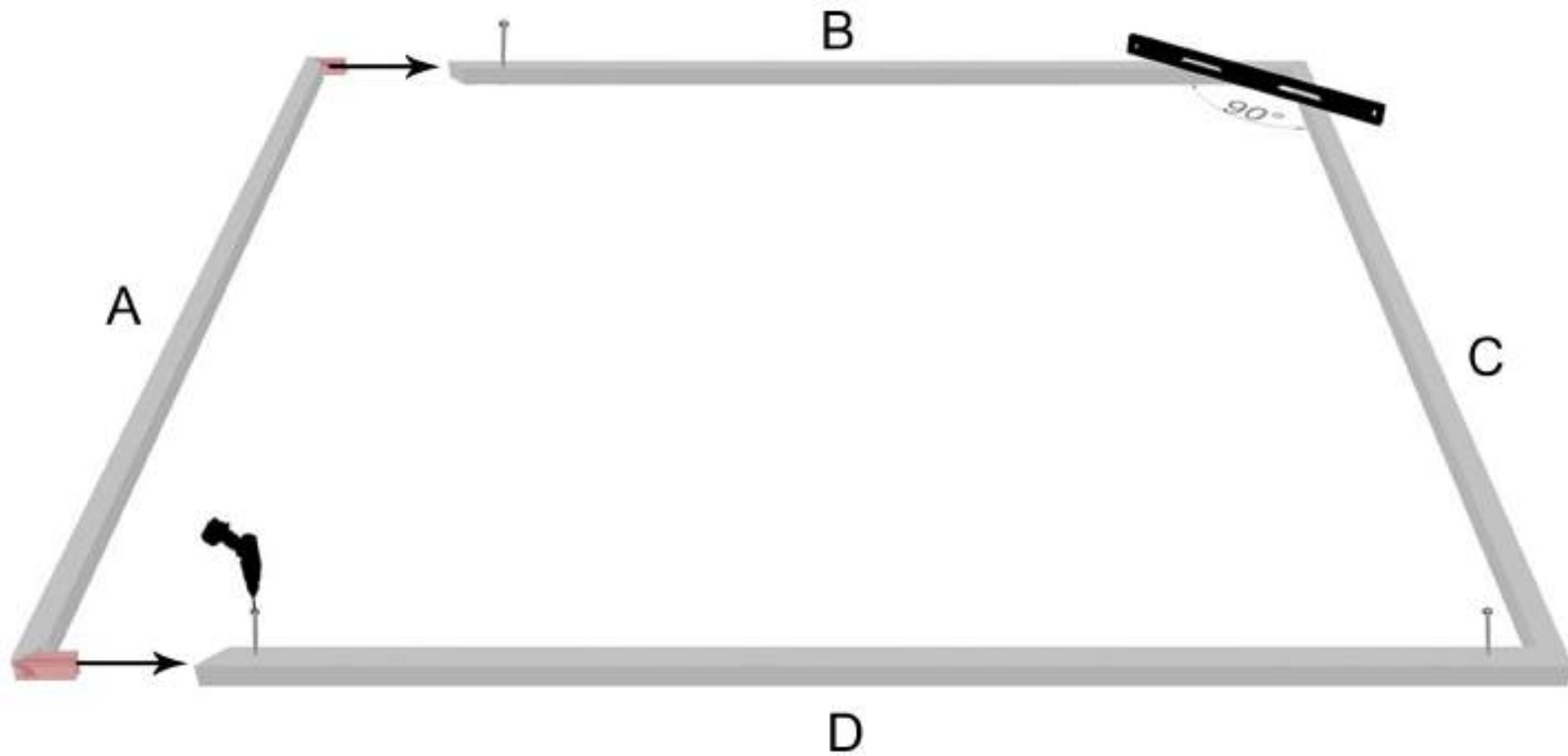

	A/C (mm)	B/D (mm)
120x180 cm	1178	1770
150x180 cm	1478	1770
150x200 cm	1478	1970

2. Walls

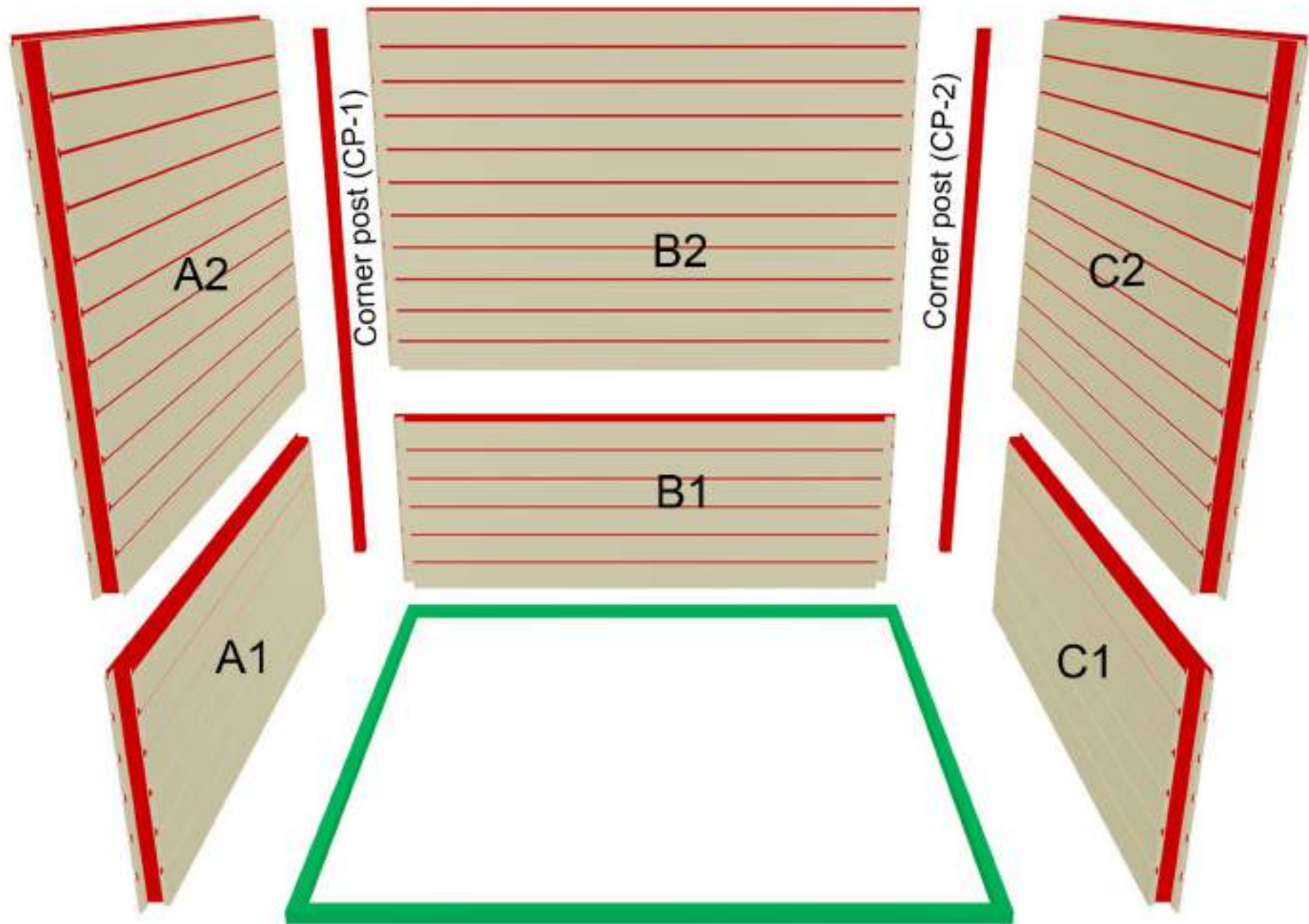

3. Multiclip closing system

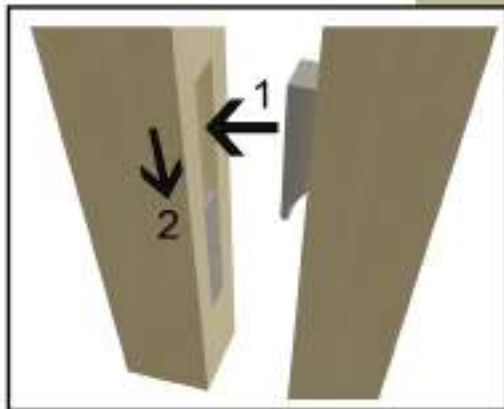
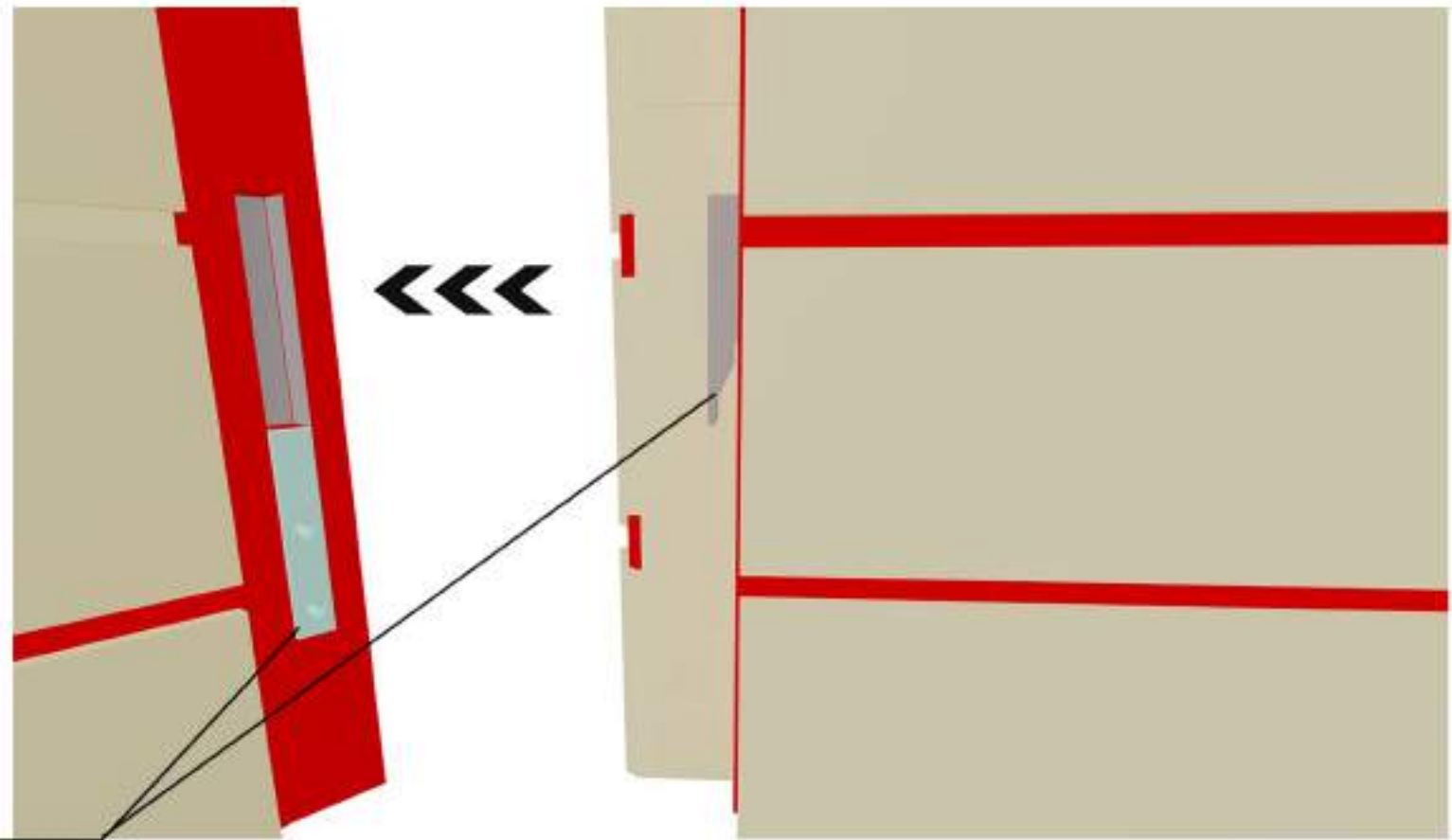

4. Fixing walls A1 & B1

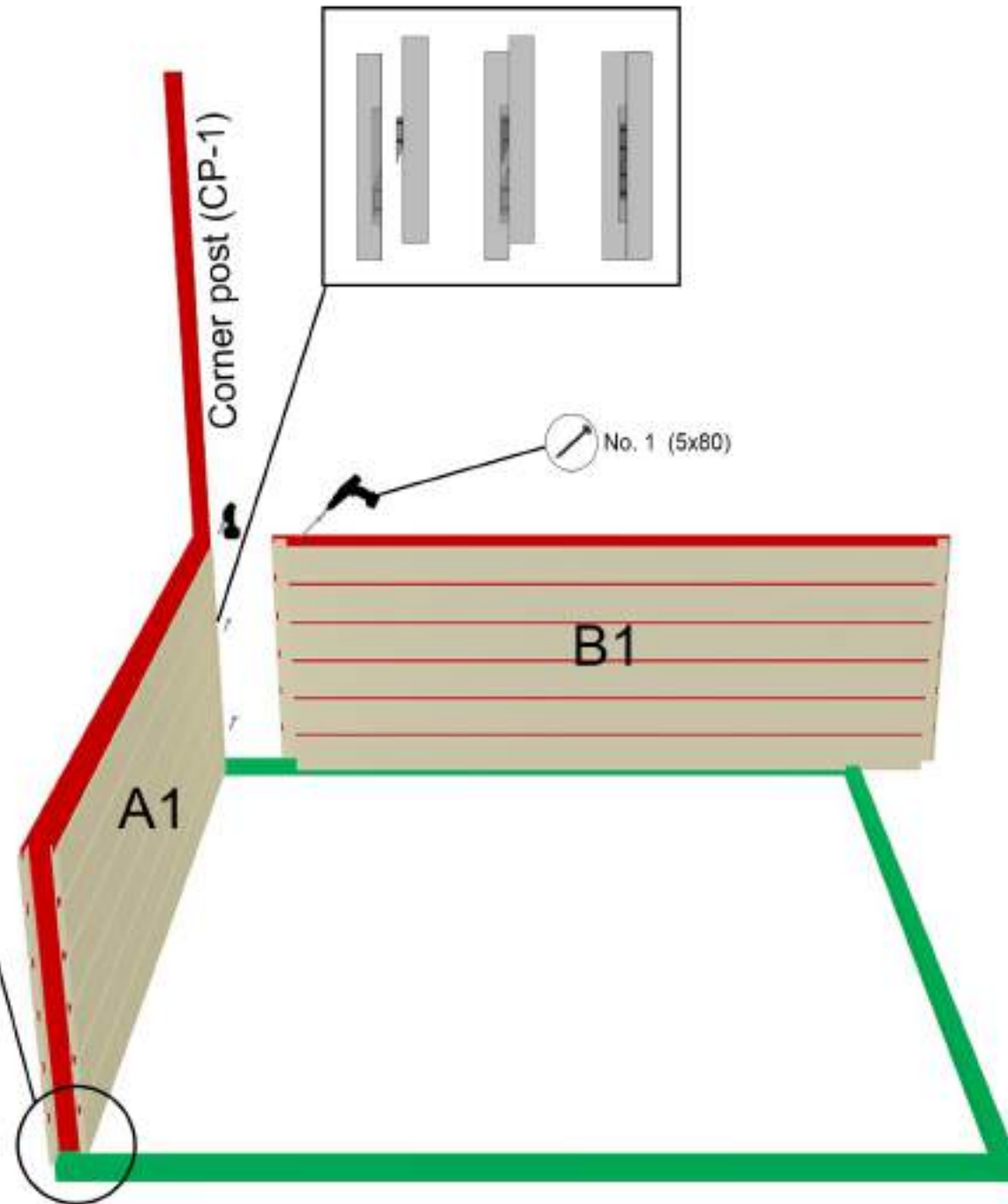
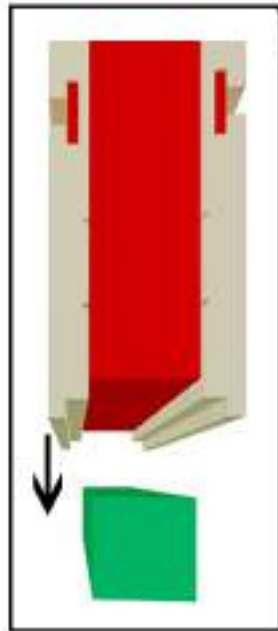
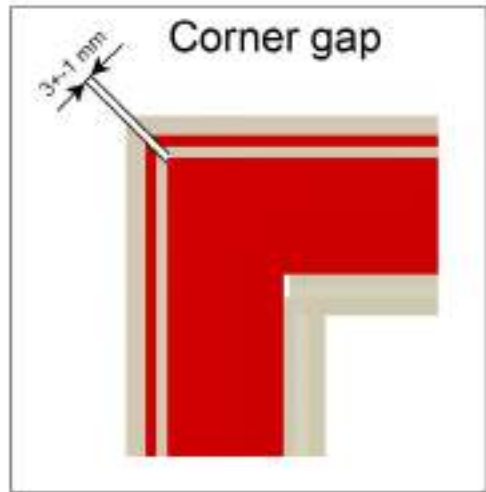

5. Fixing wall A2 & B2

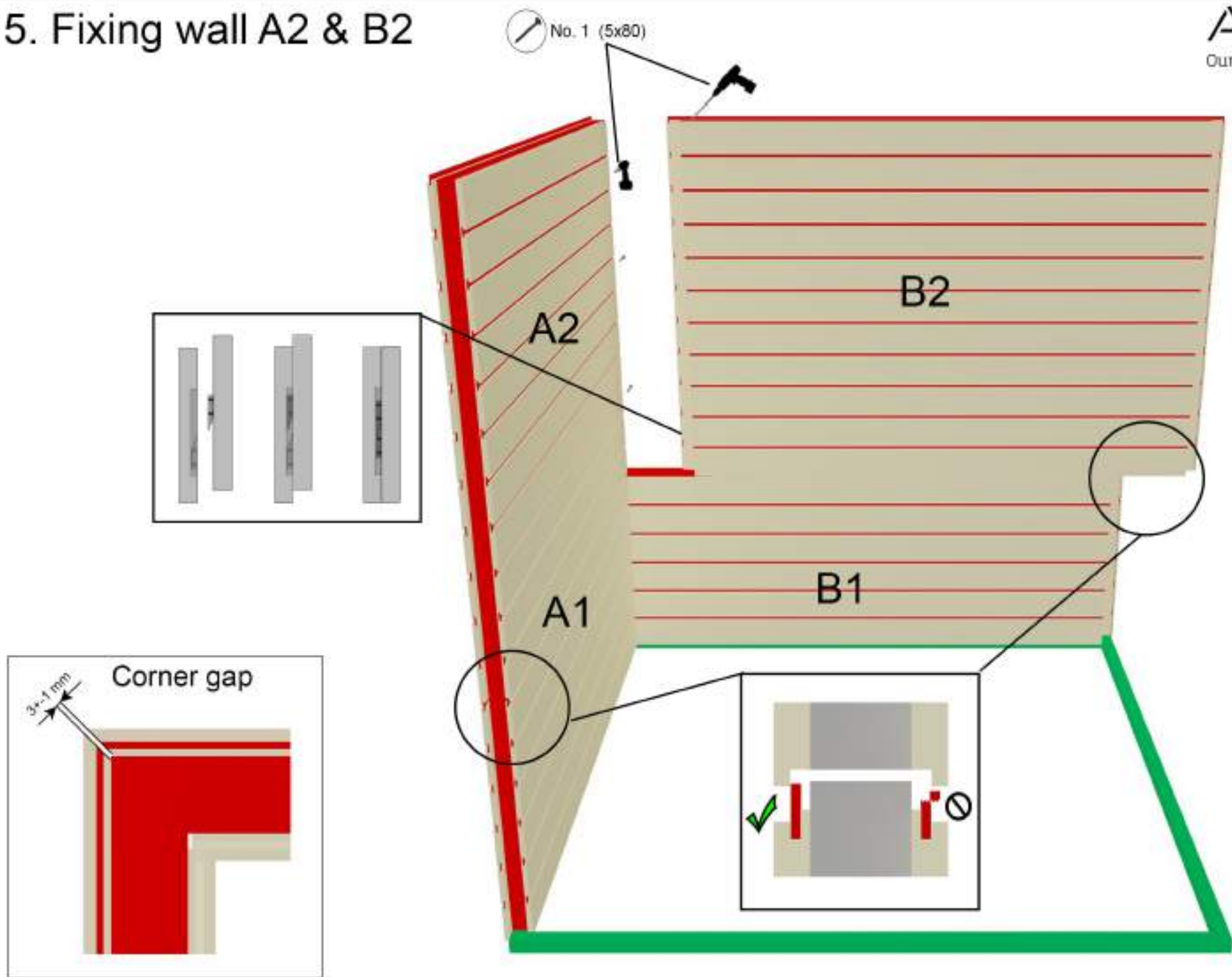

6. Fixing corner post

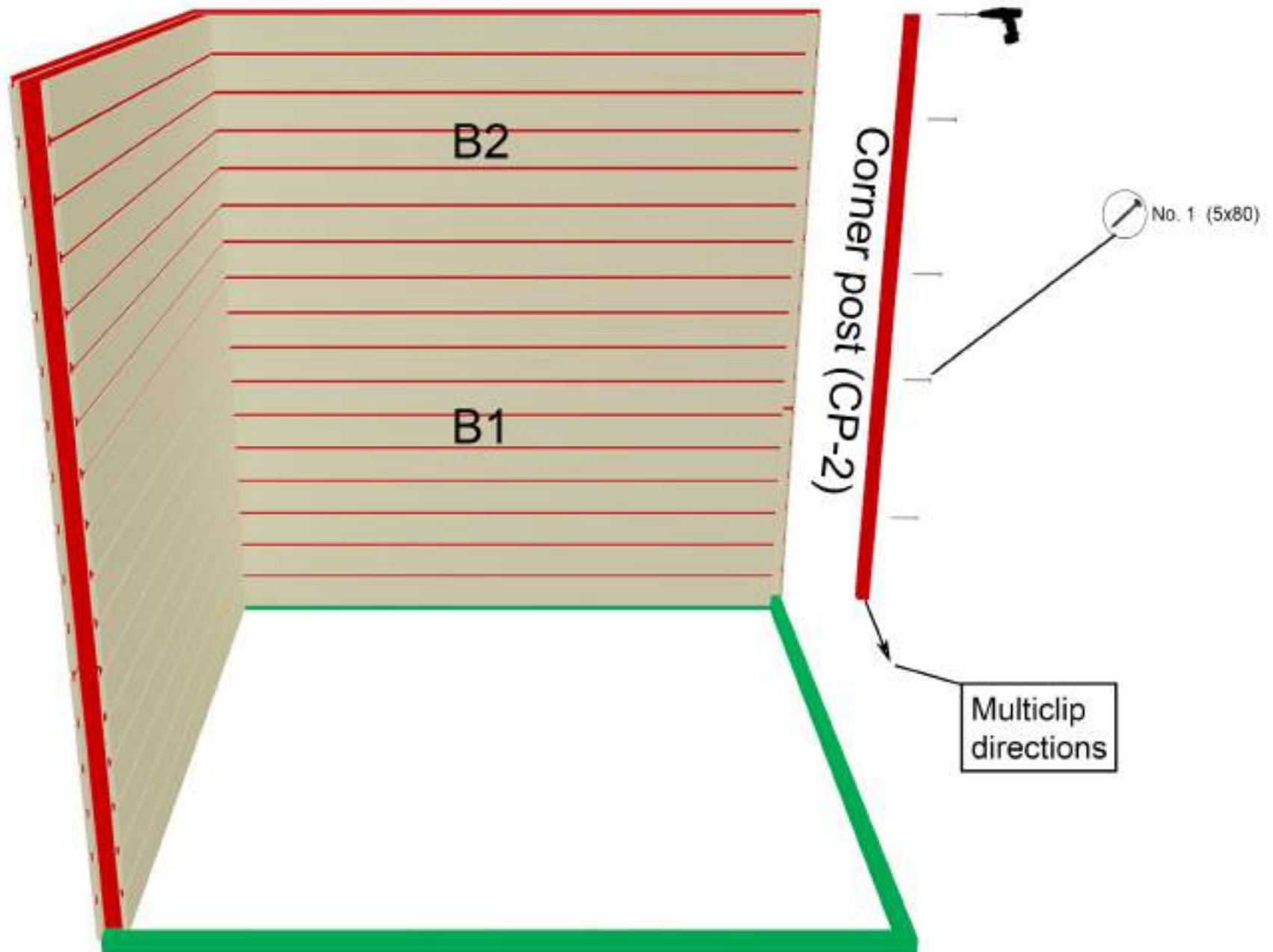

7. Fixing walls C1&C2

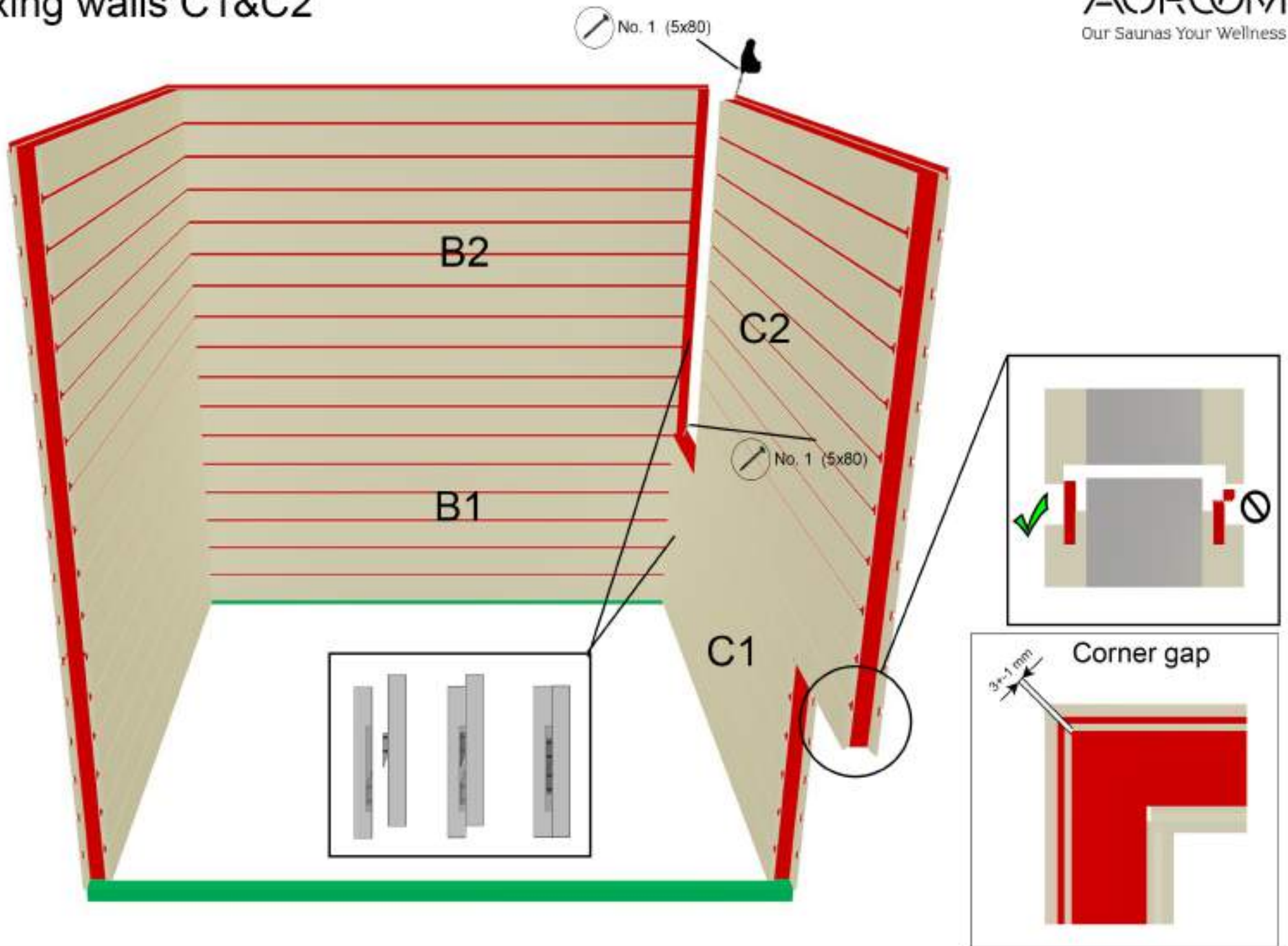

8. Fixing ceilings

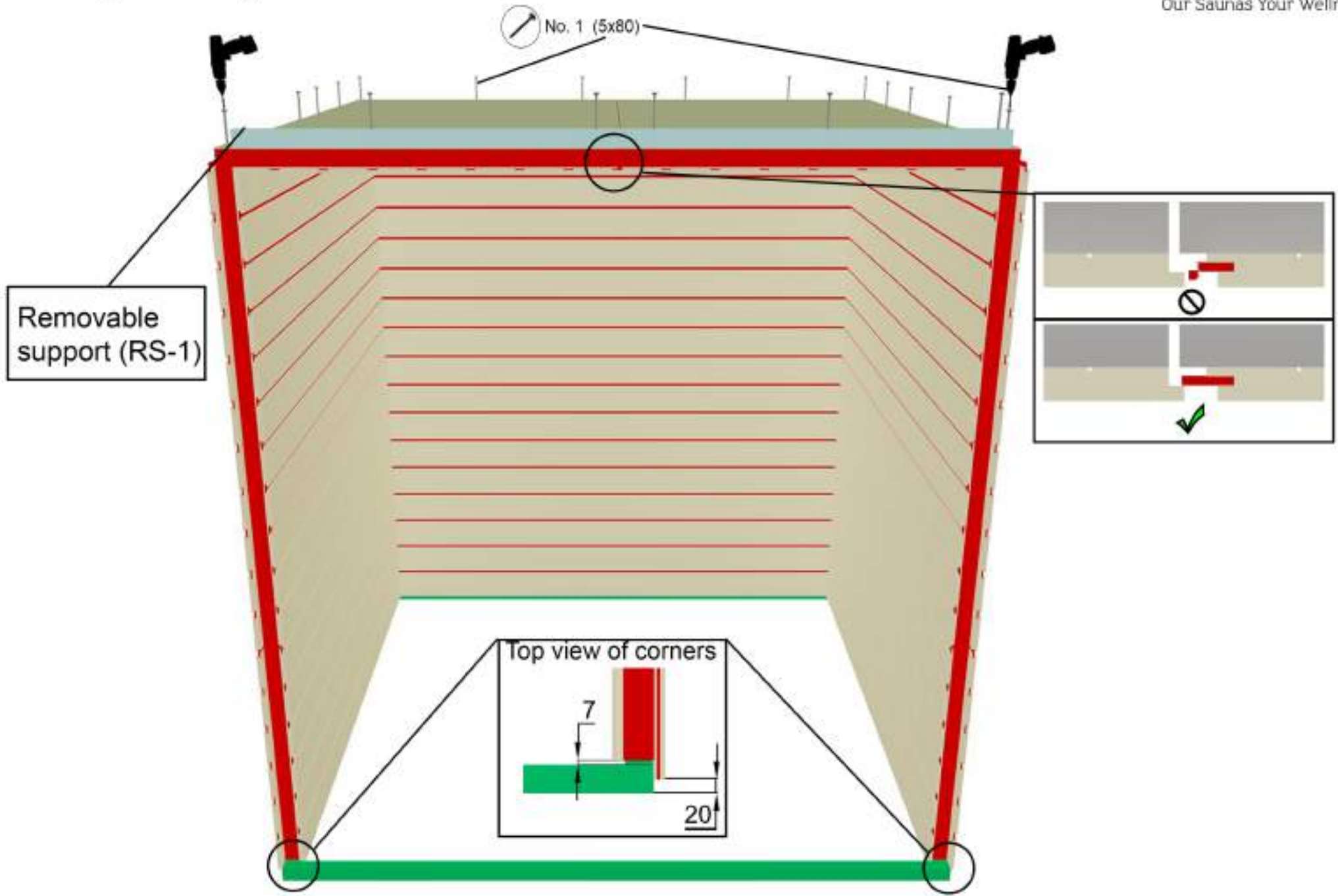

9. Wiring inside walls

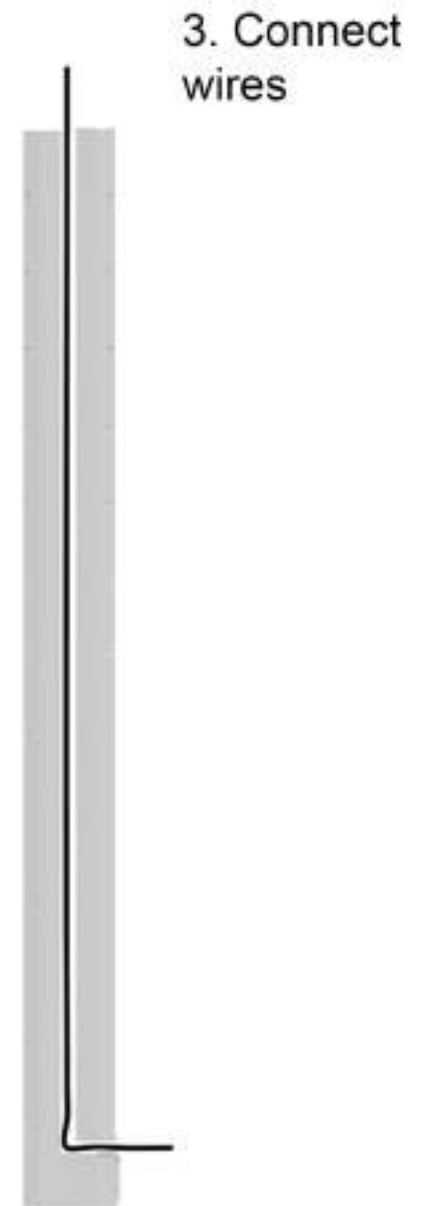
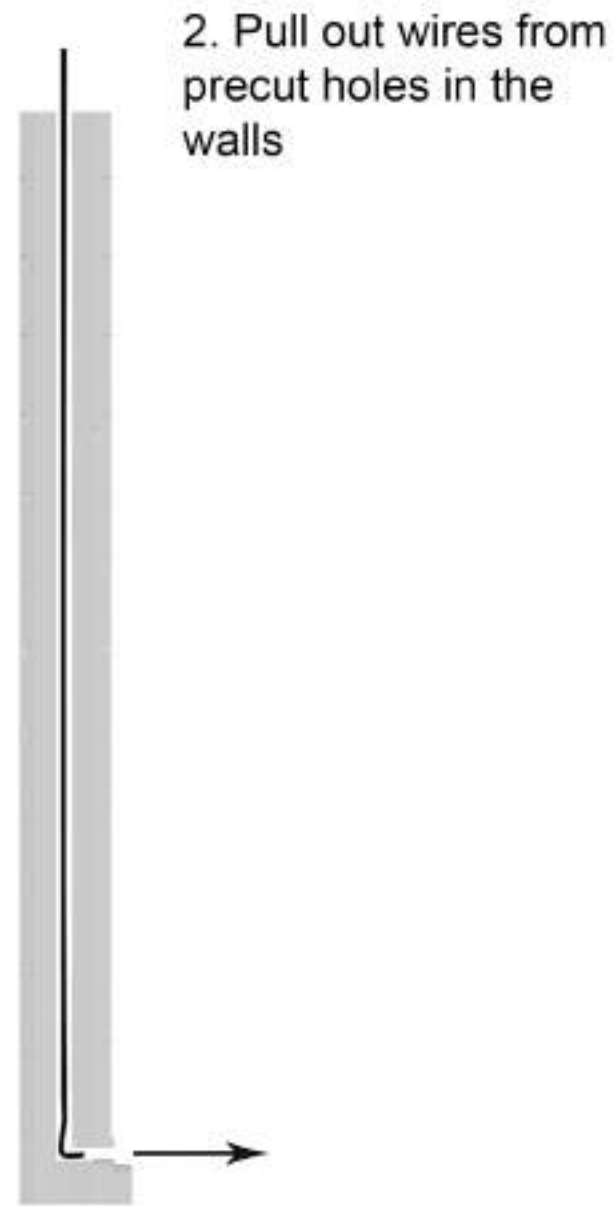
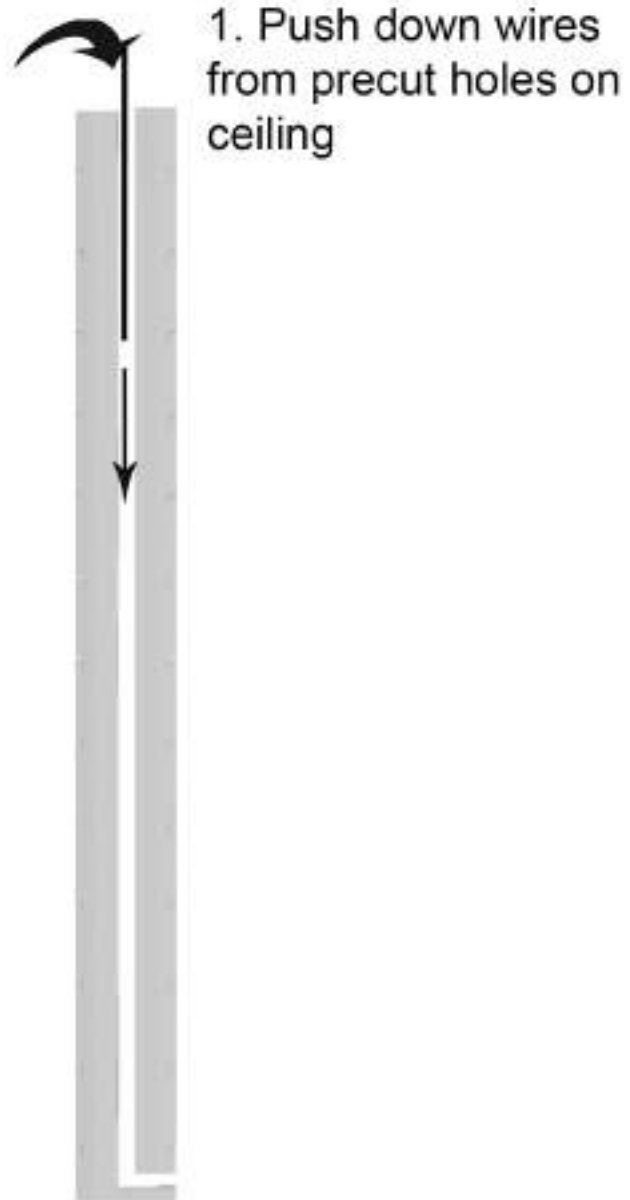

10. Interior
120x180 cm
150x180 cm
150x200 cm

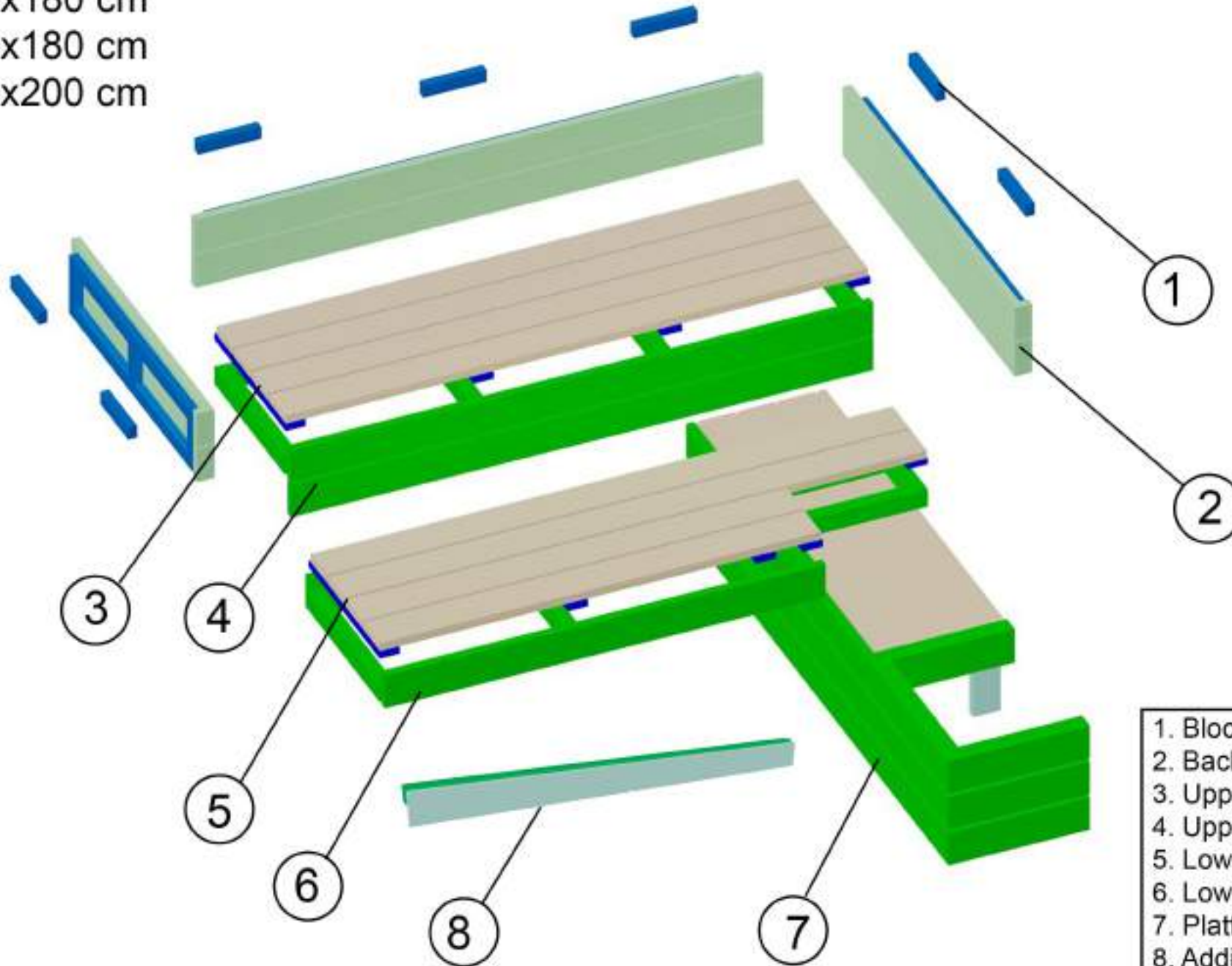

- 1. Block for fixing backrests
- 2. Backrests
- 3. Upper bench grid
- 4. Upper bench frame
- 5. Lower bench grid
- 6. Lower bench frame
- 7. Platform
- 8. Additional support for model 120x180 cm

10.1 Assembly of platform

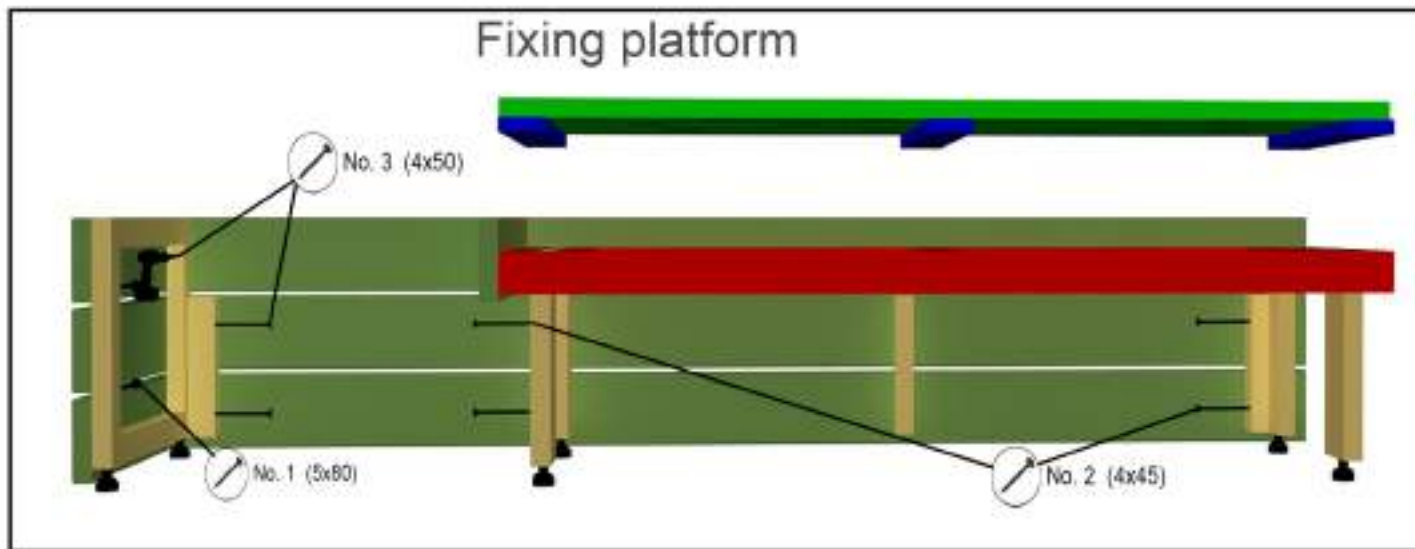
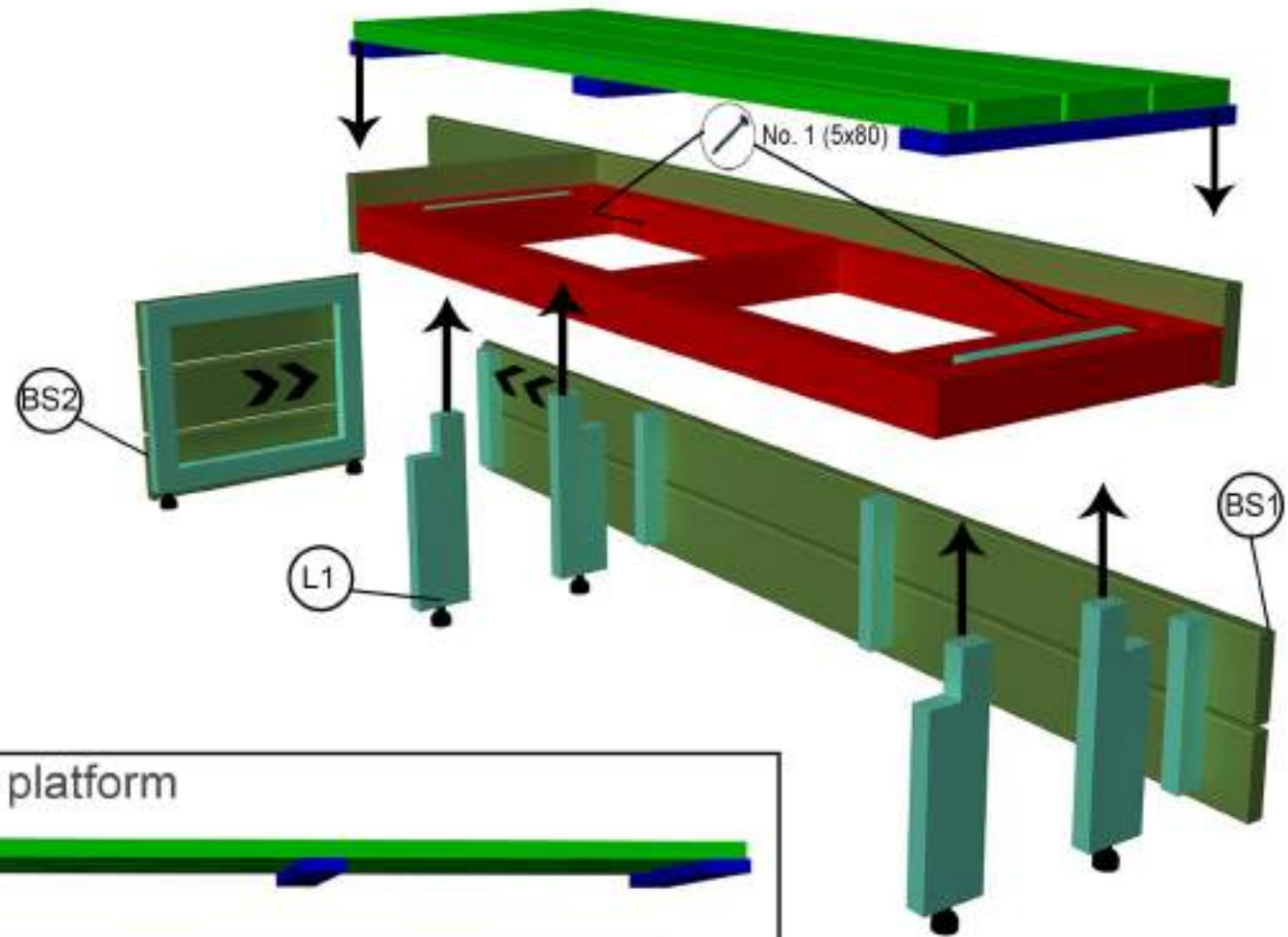

10.2 Upper bench frame & blocks for backrest

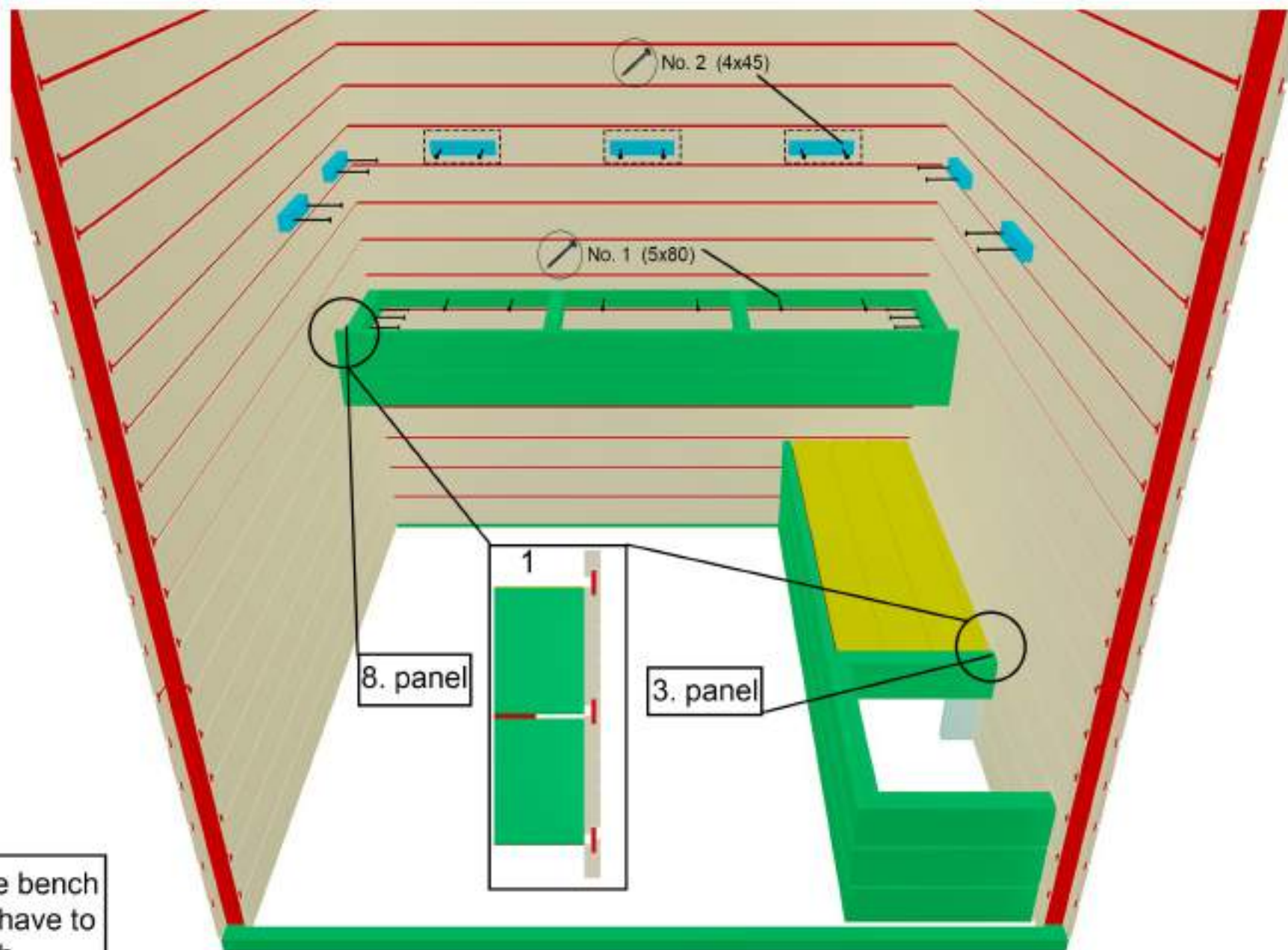

1. Frontside of the bench frame & platform have to be same level with paneling as shown

10.3 Cariitti optic fibre for upper bench (Optional)

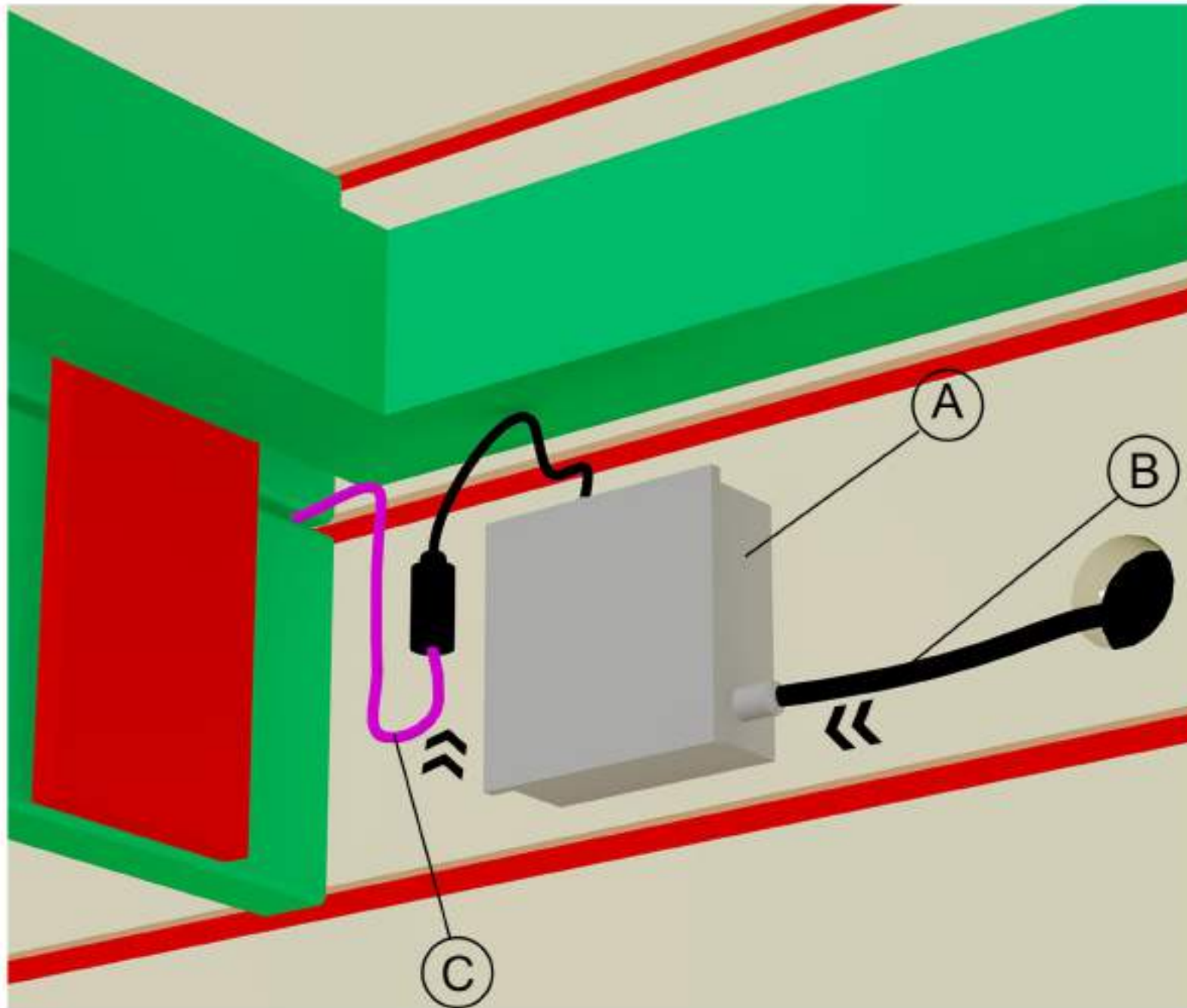

- A. Projector
- B. Power cable
- C. Fibre

1. Push down power cable from the ceiling
2. Connect power cable with projector
3. Push fiber in gap between upper bench frontboards
4. Connect fibre with projector

10.4 Lower bench frame fixing

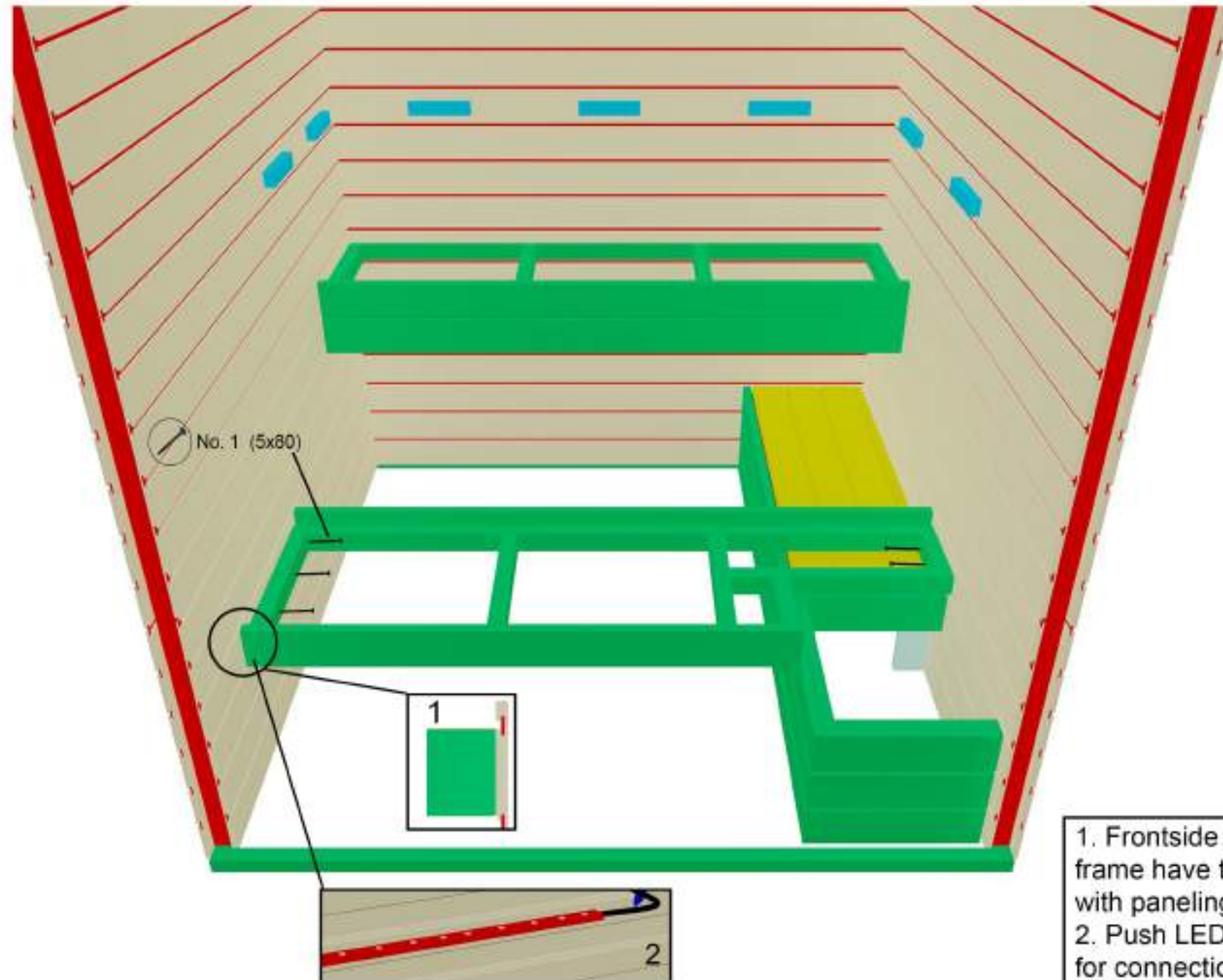

10.5 Additional support fixing 120x180 cm

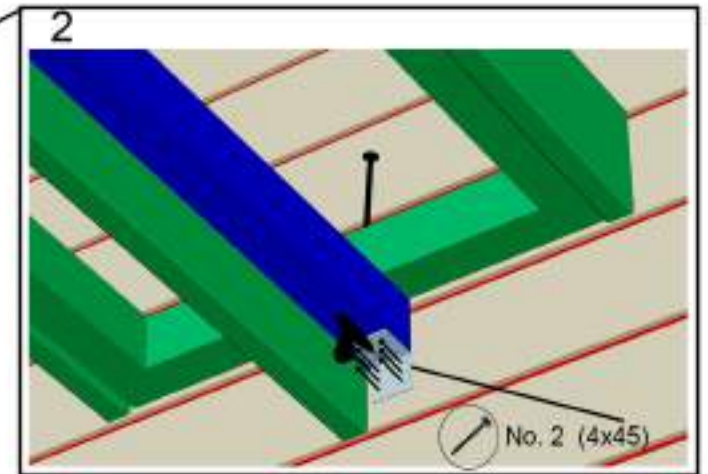
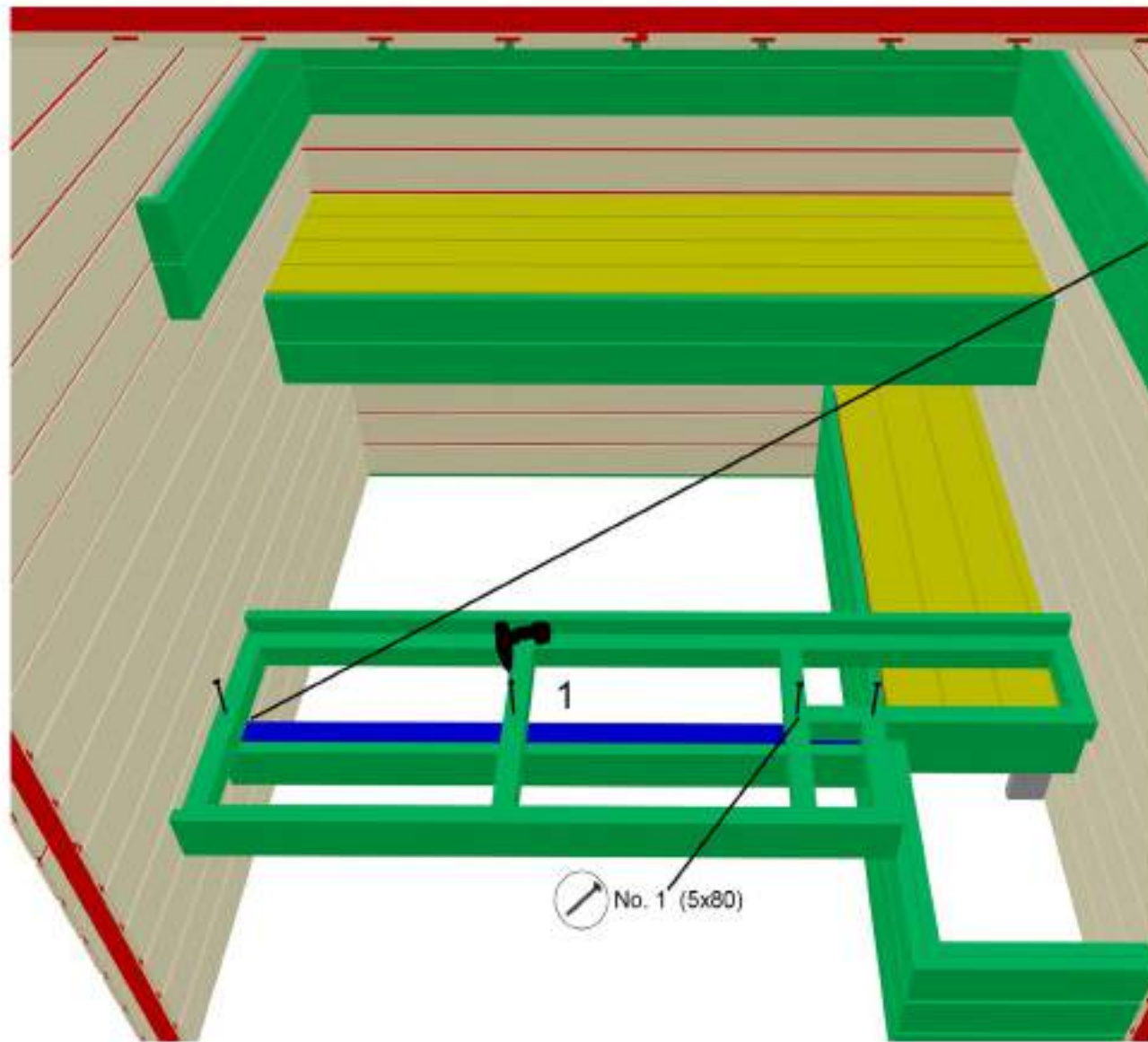

11. Backrest LED-strips

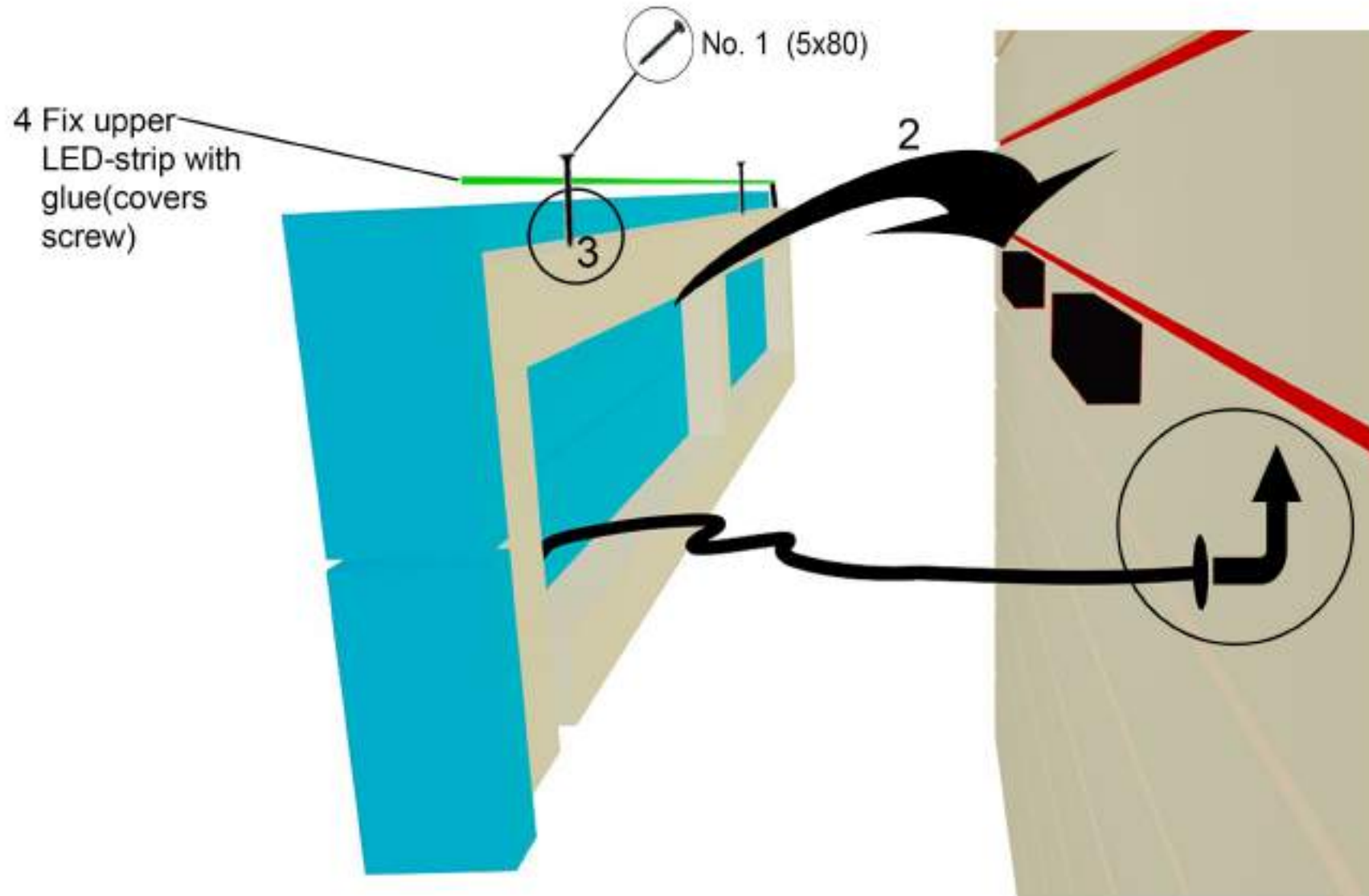

11.1 Fixing backrests

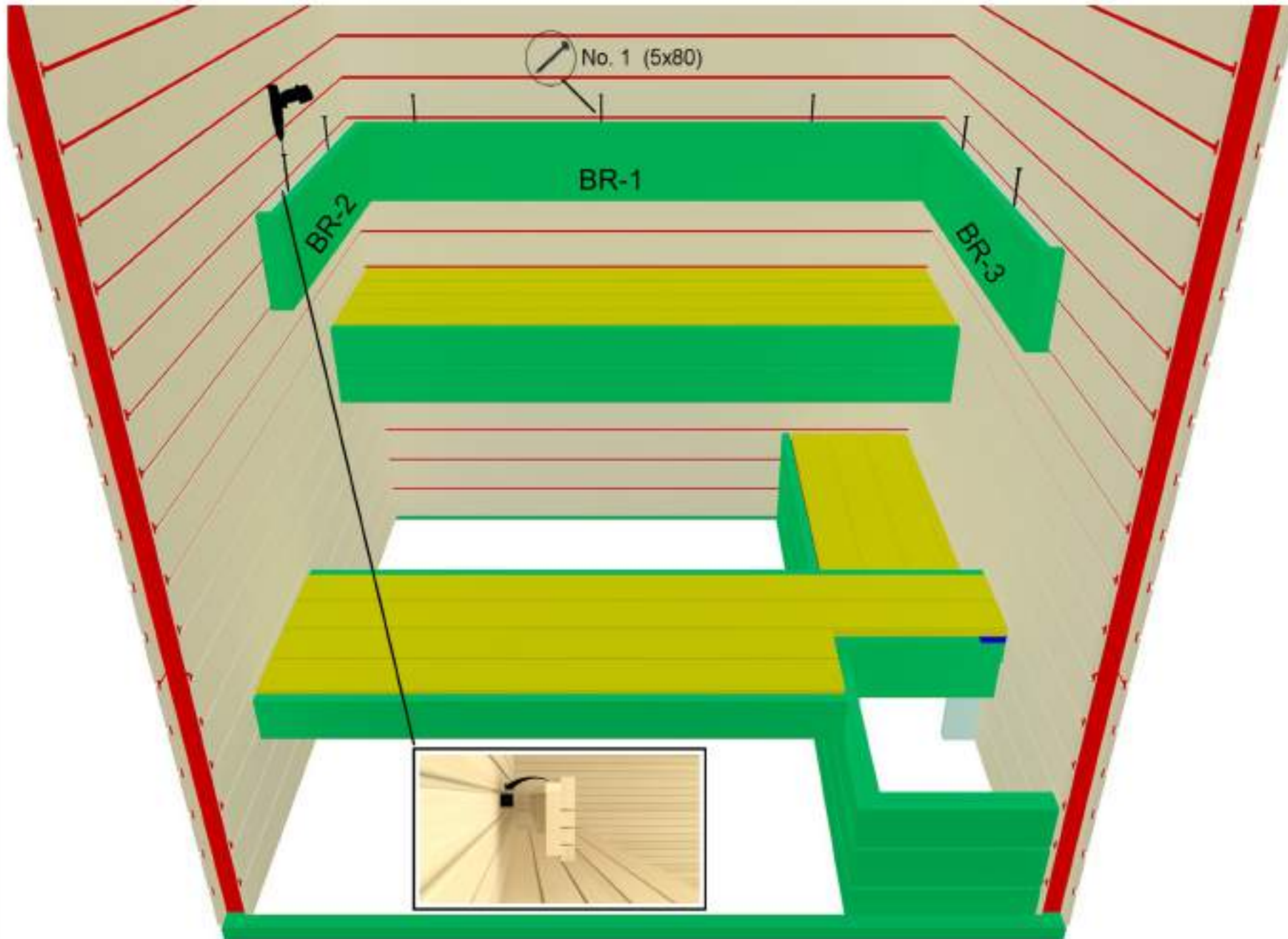

12. Interior II

120x180 cm

150x180 cm

150x200 cm

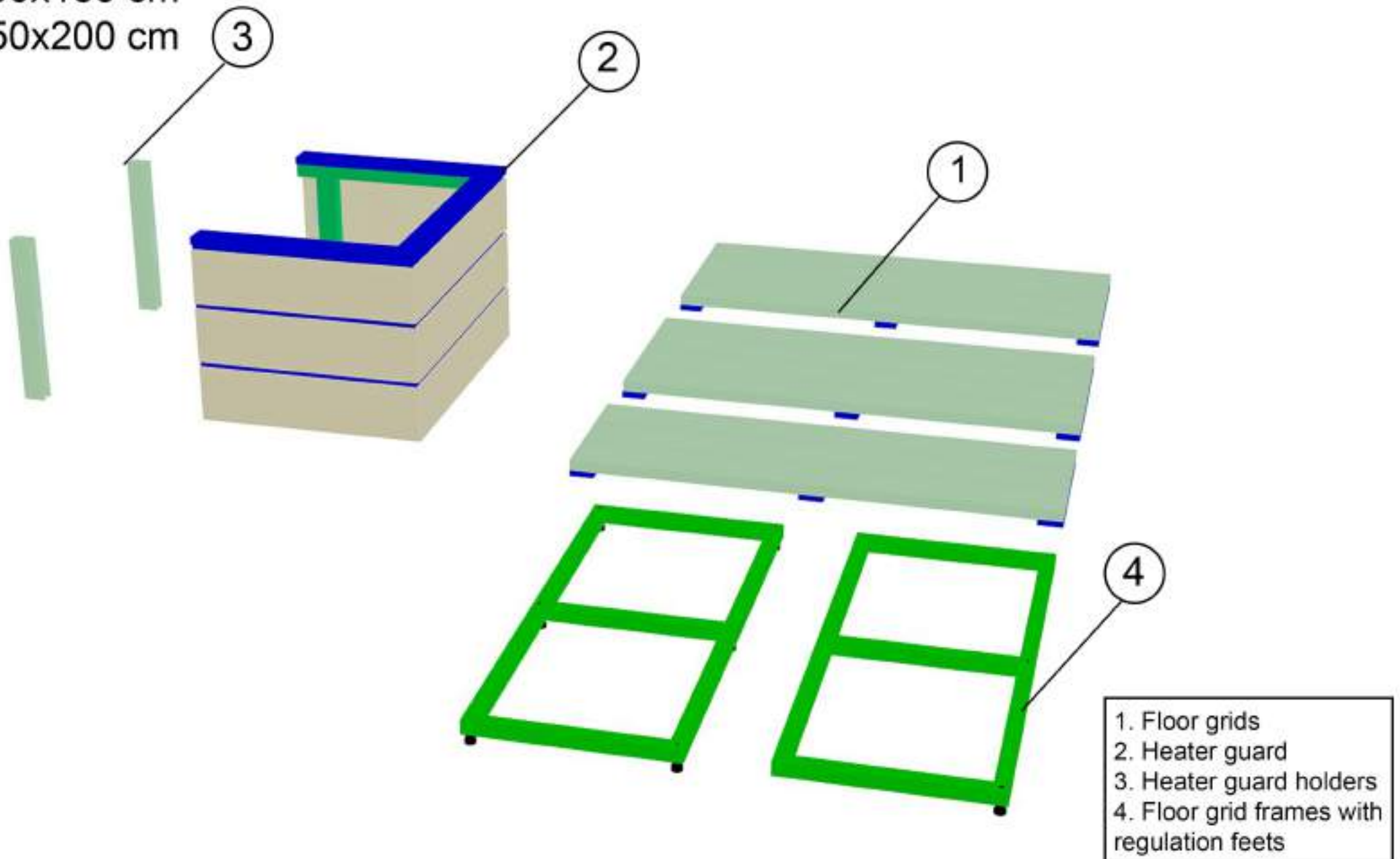

13. Fixing heater guard

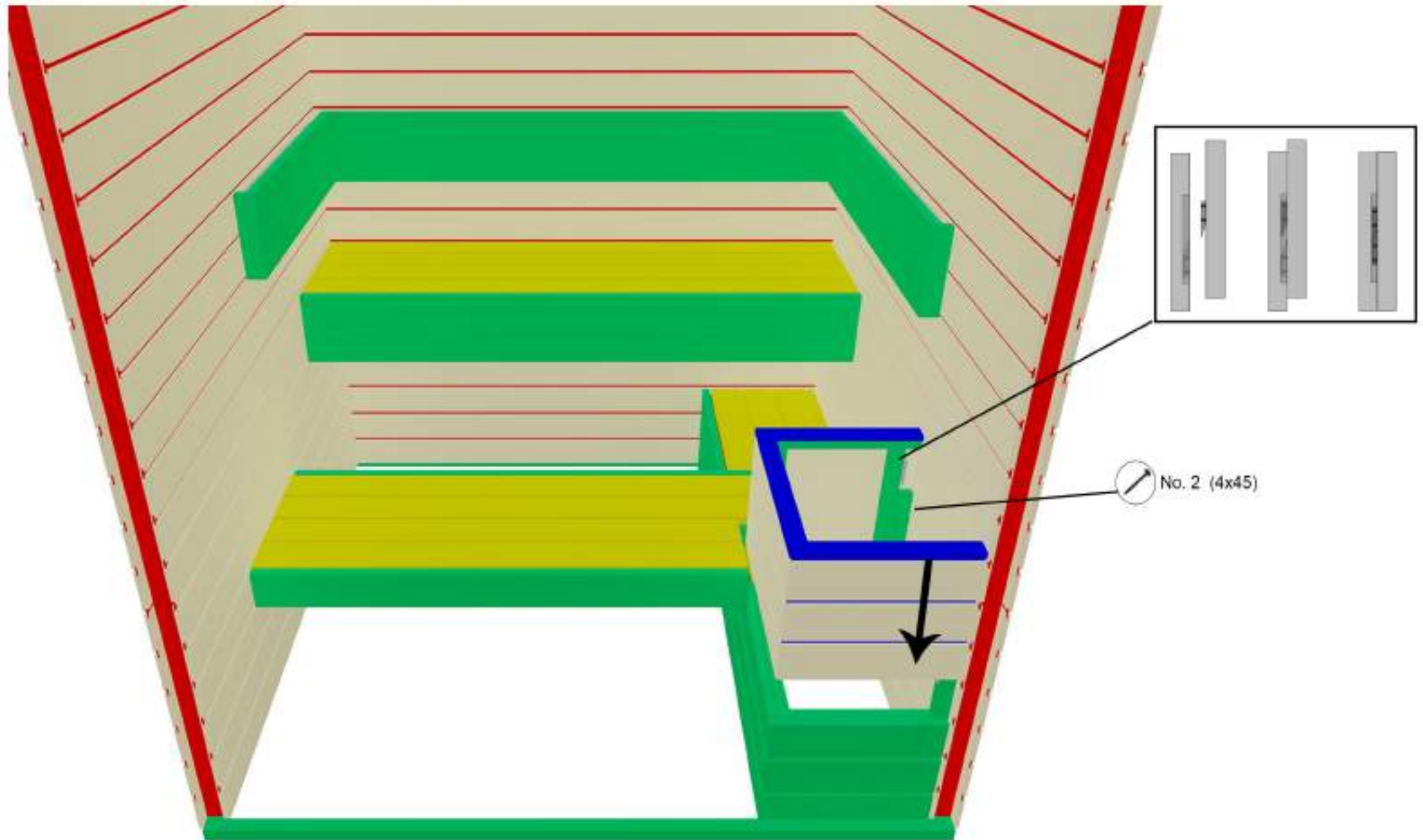

14. Glass wall & door frames

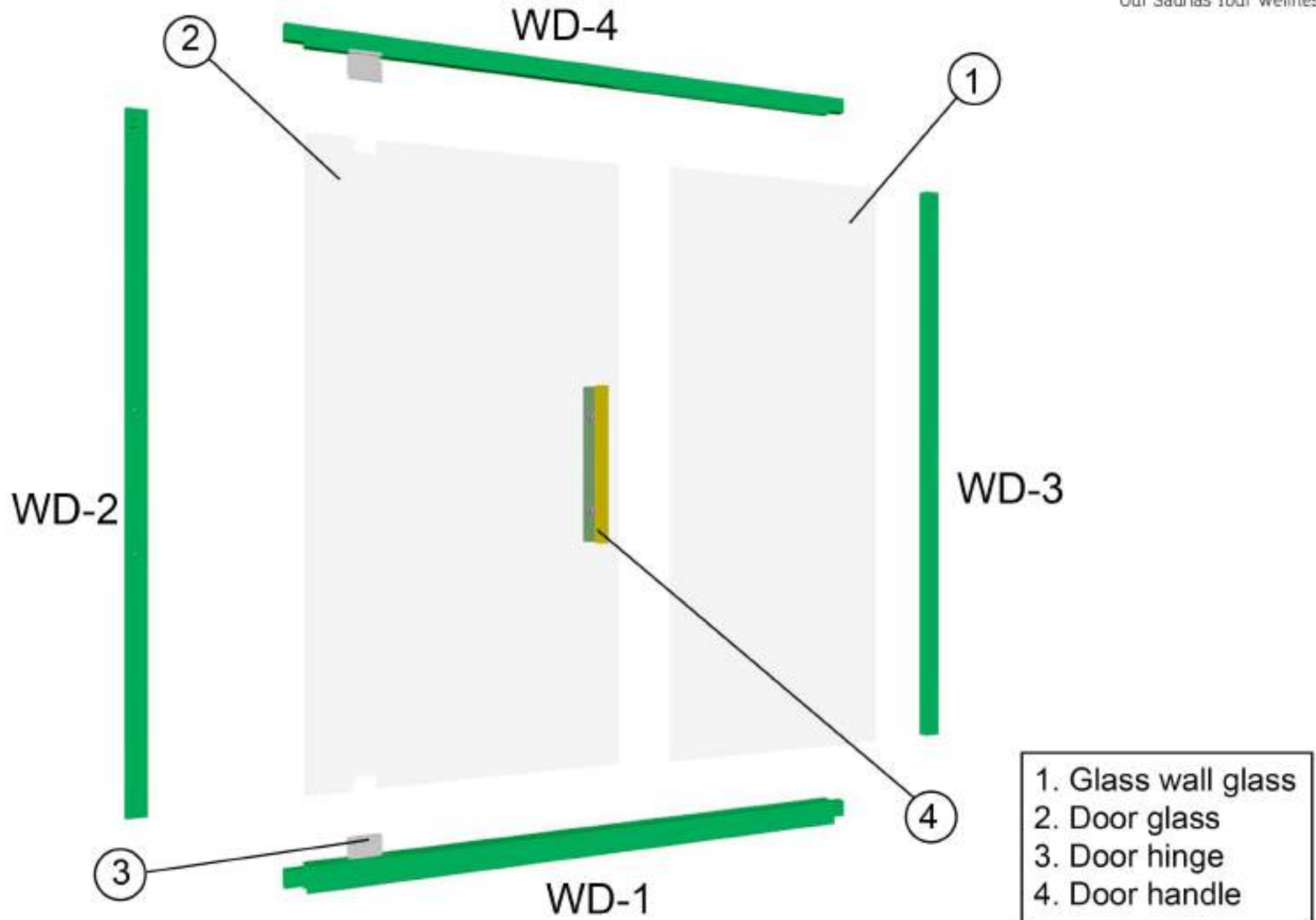

15. Fixing glass wall & door frames

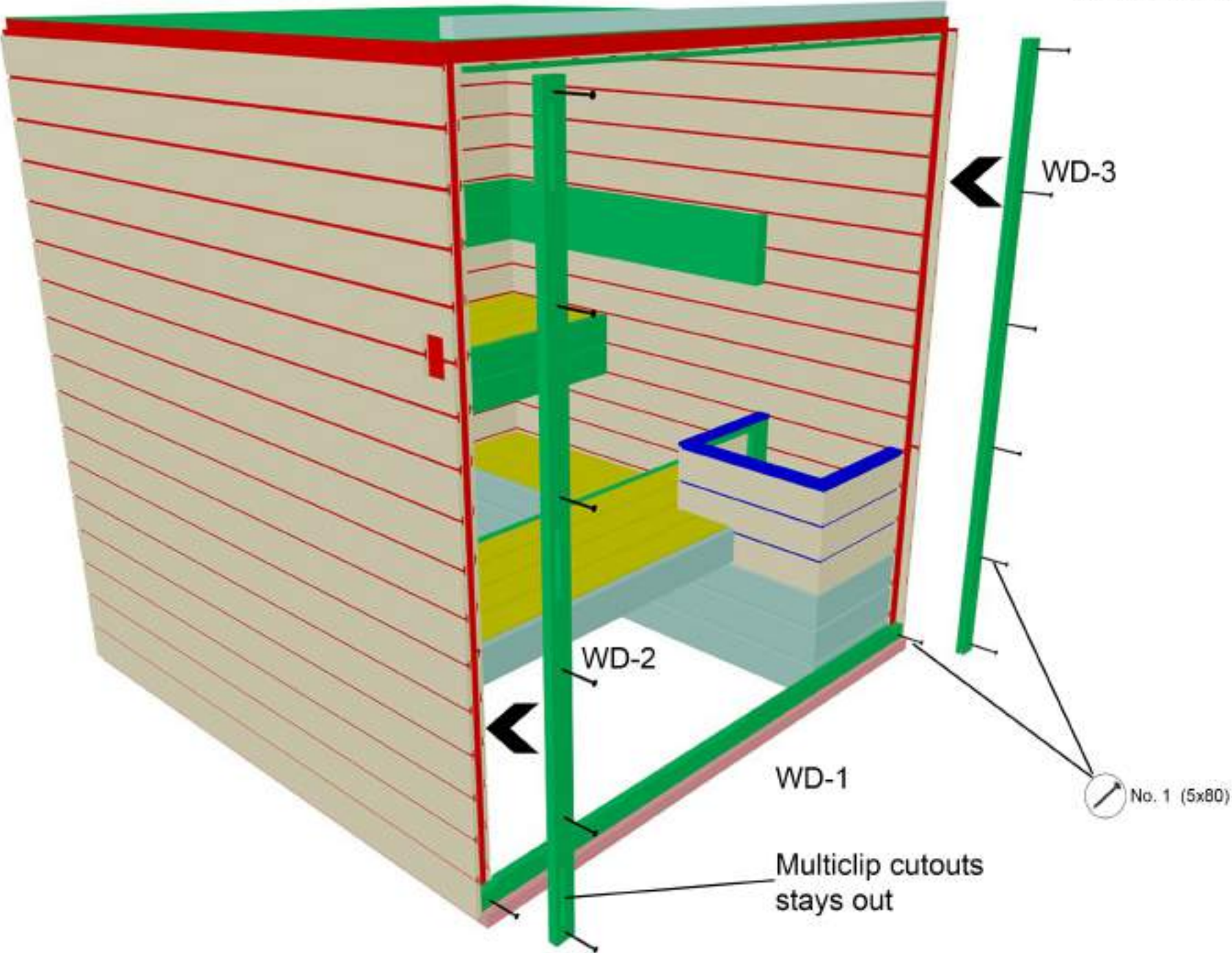

15.1 Fixing glass wall

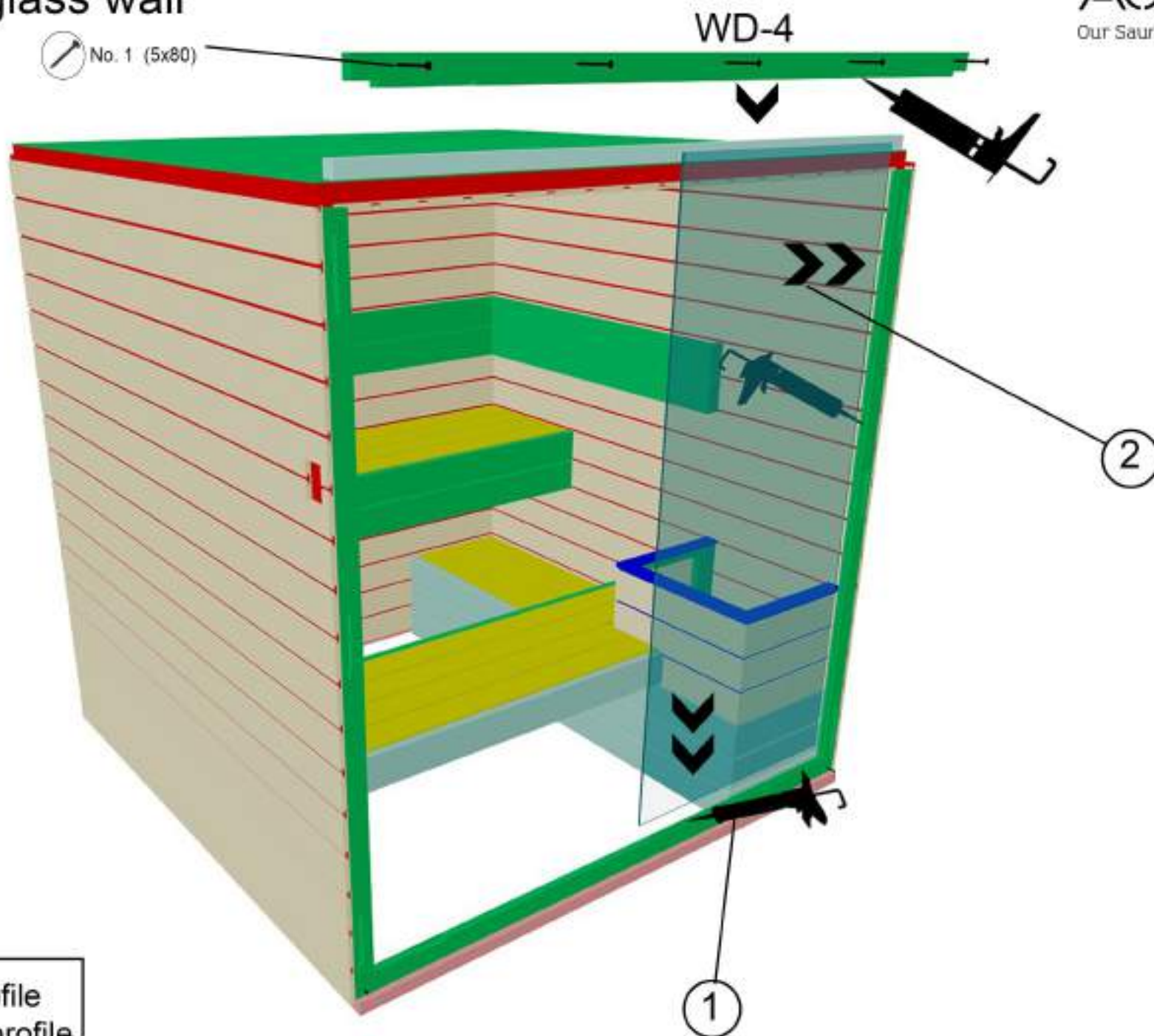

1. Add glue in u-profile
2. Push glass in u-profile

15.2 Multiclips for frames

RS-1

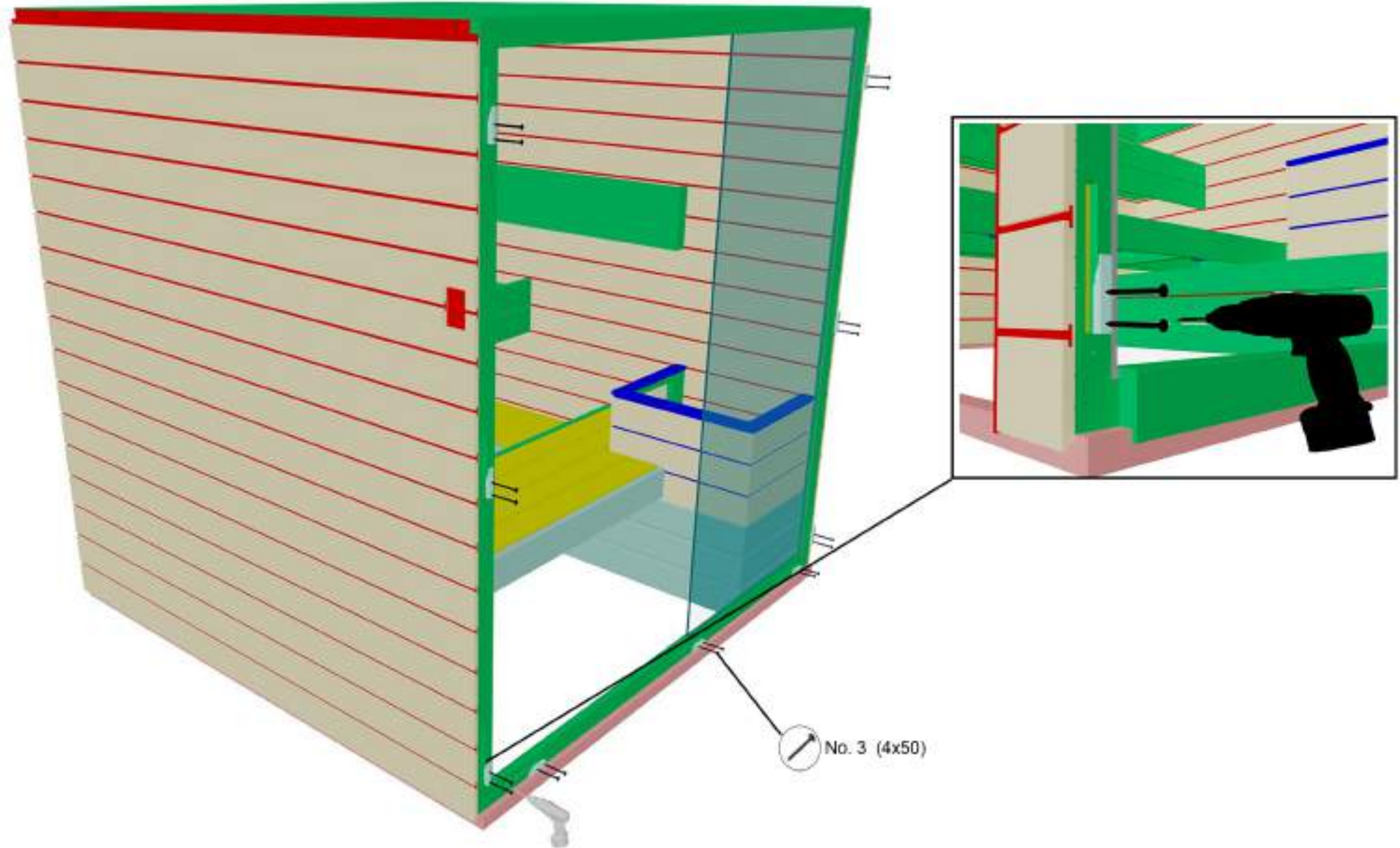

15.3 Door hinges and glass

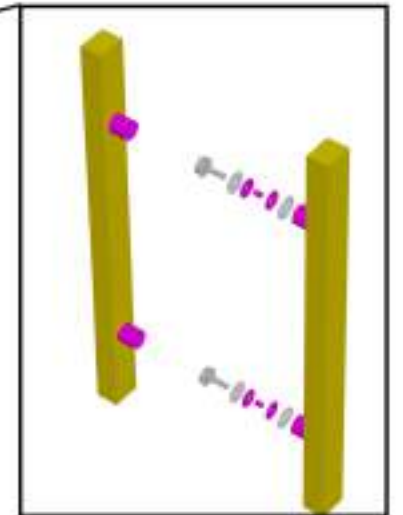
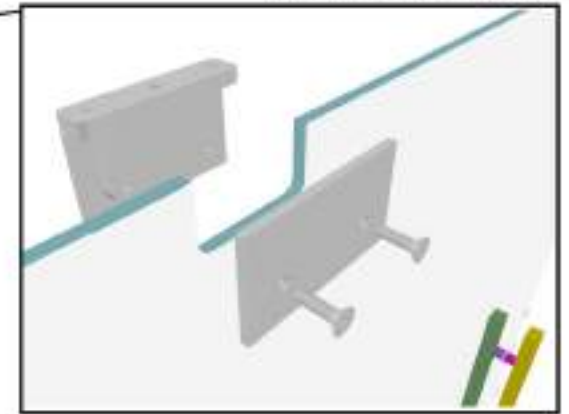
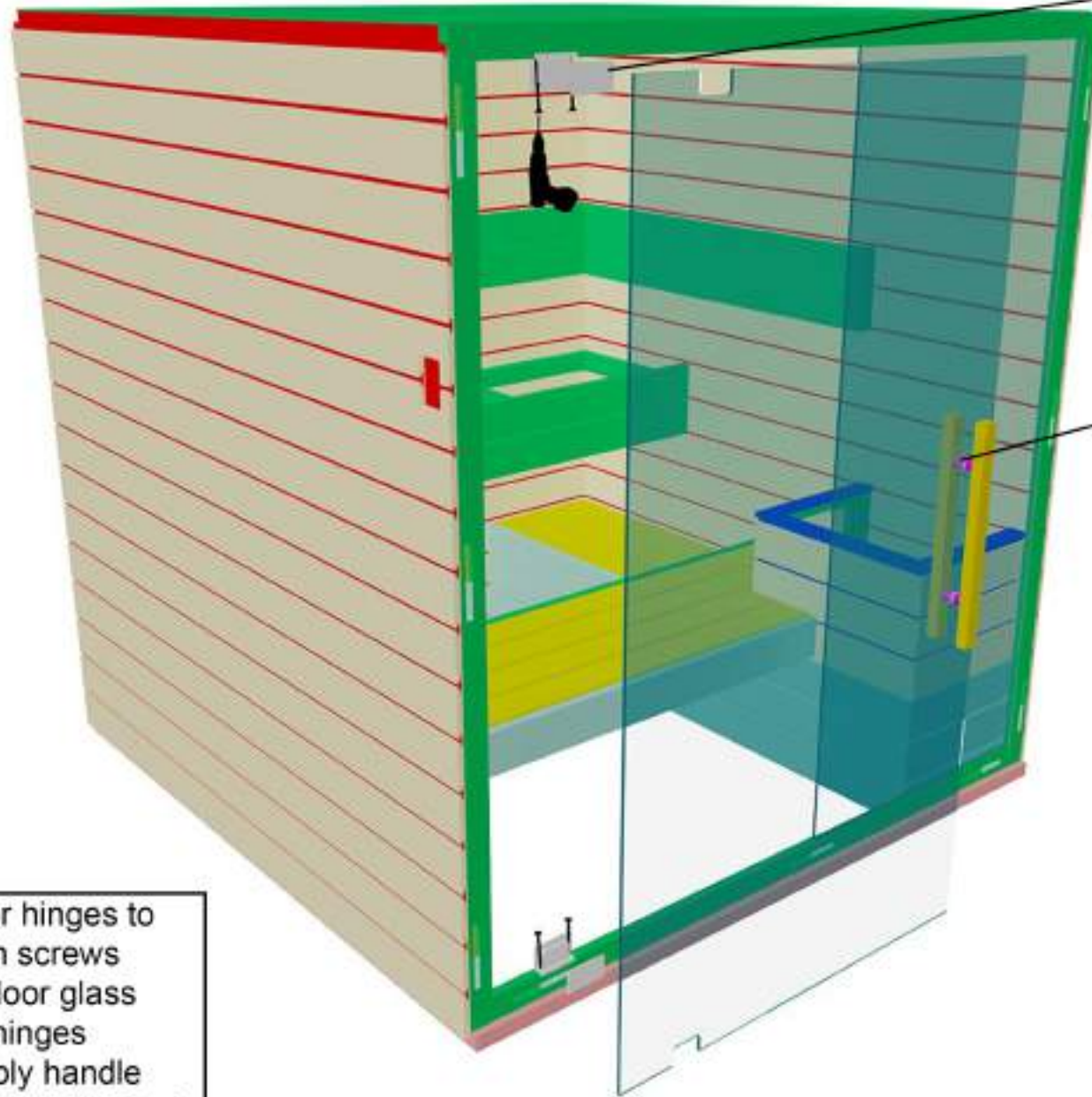

1. Fix door hinges to frame with screws
2. Place door glass between hinges
3. Assembly handle
3. Read hinge manual for regulation

16. Upper frame

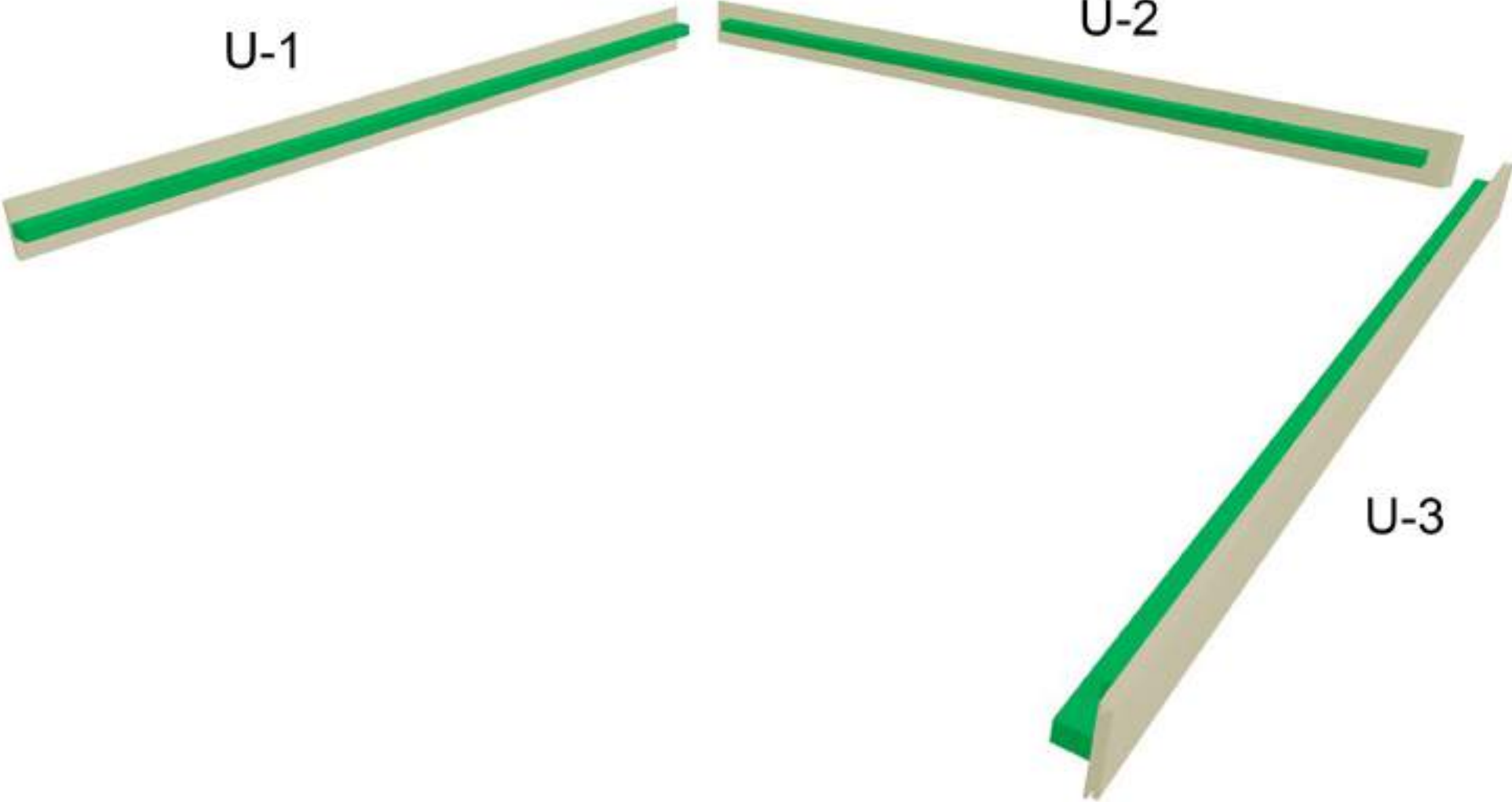

17. Fixing upper frame

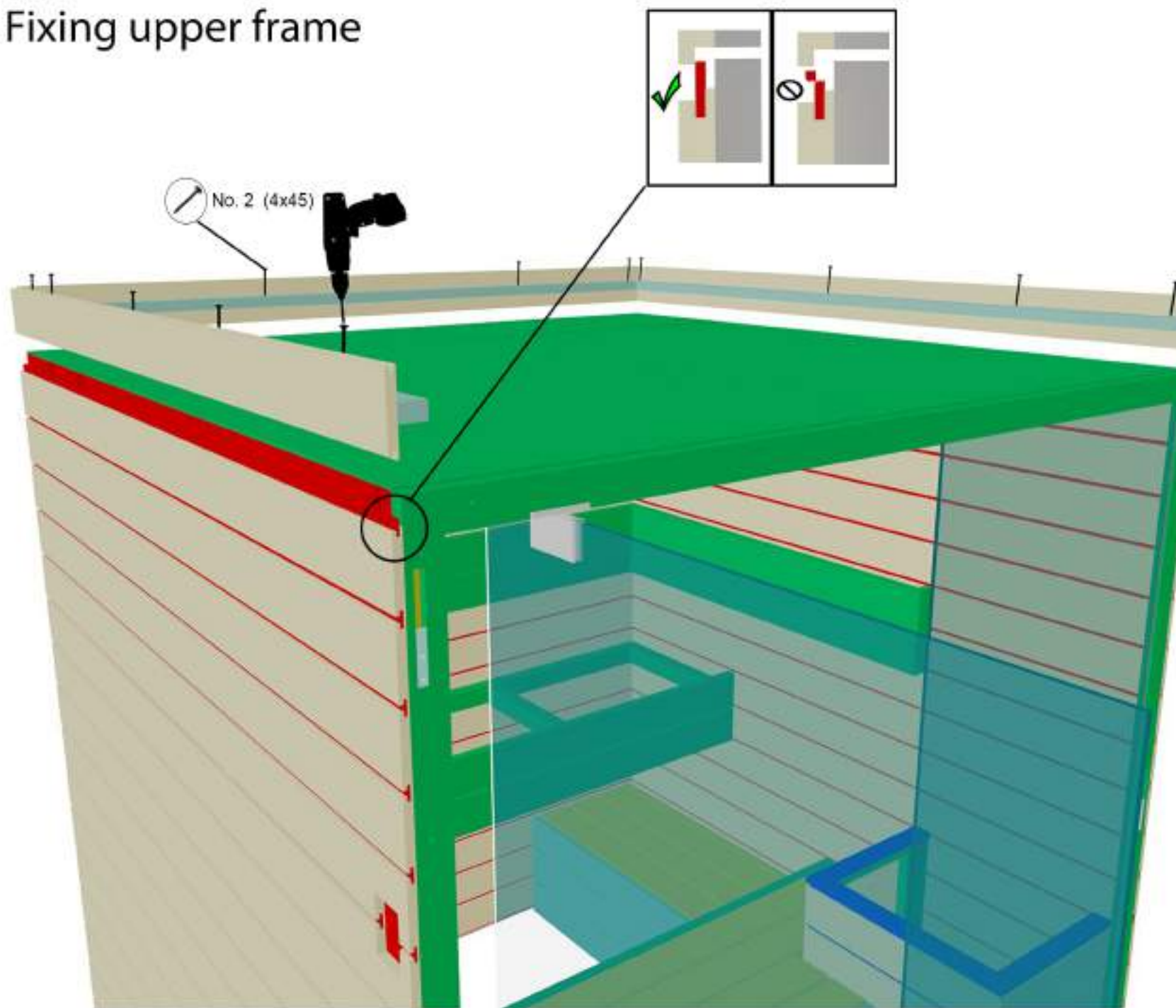

18. Front frame

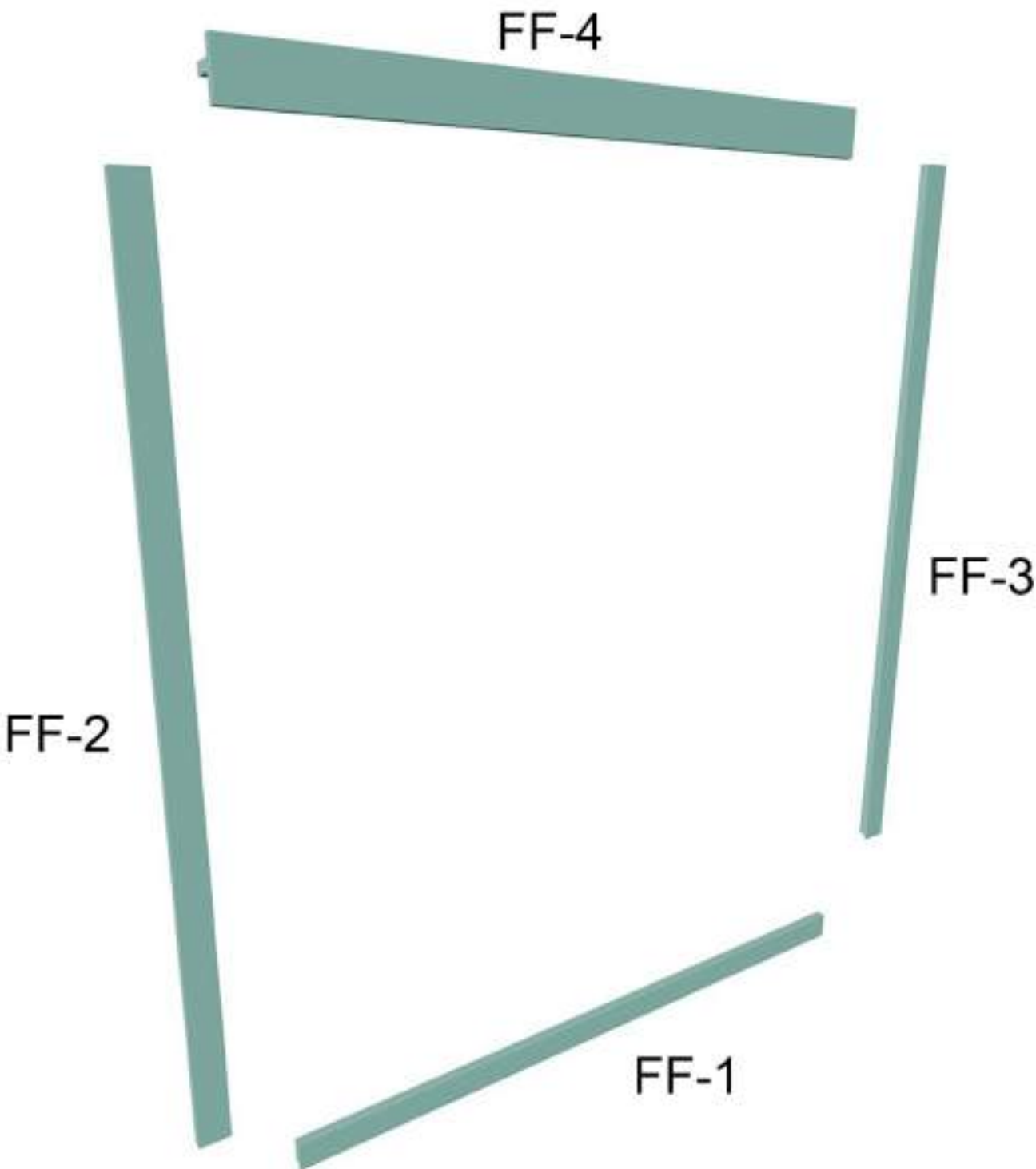

19. Fixing front frame

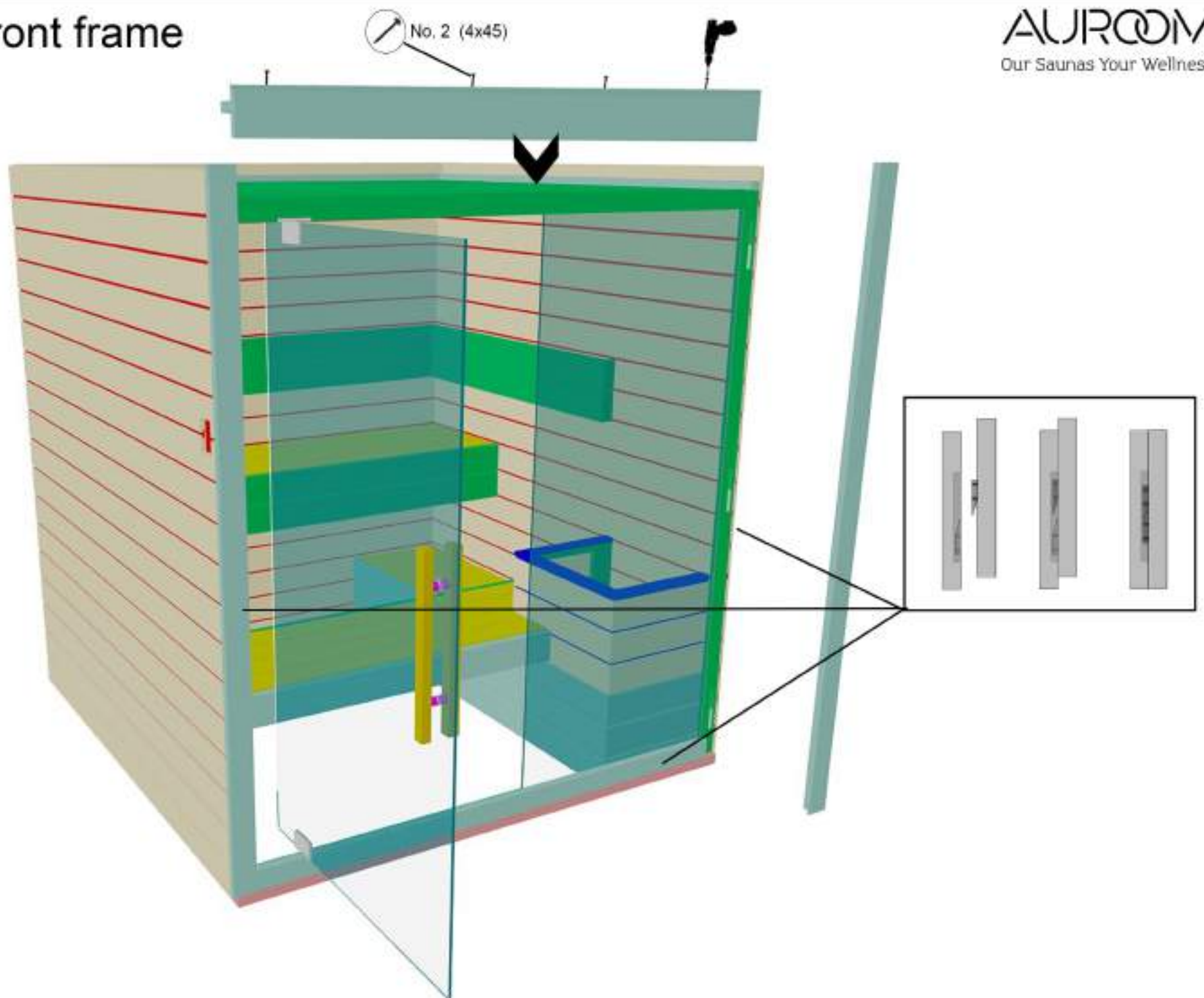

20. Floor frames

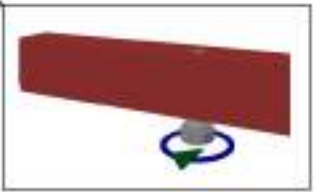
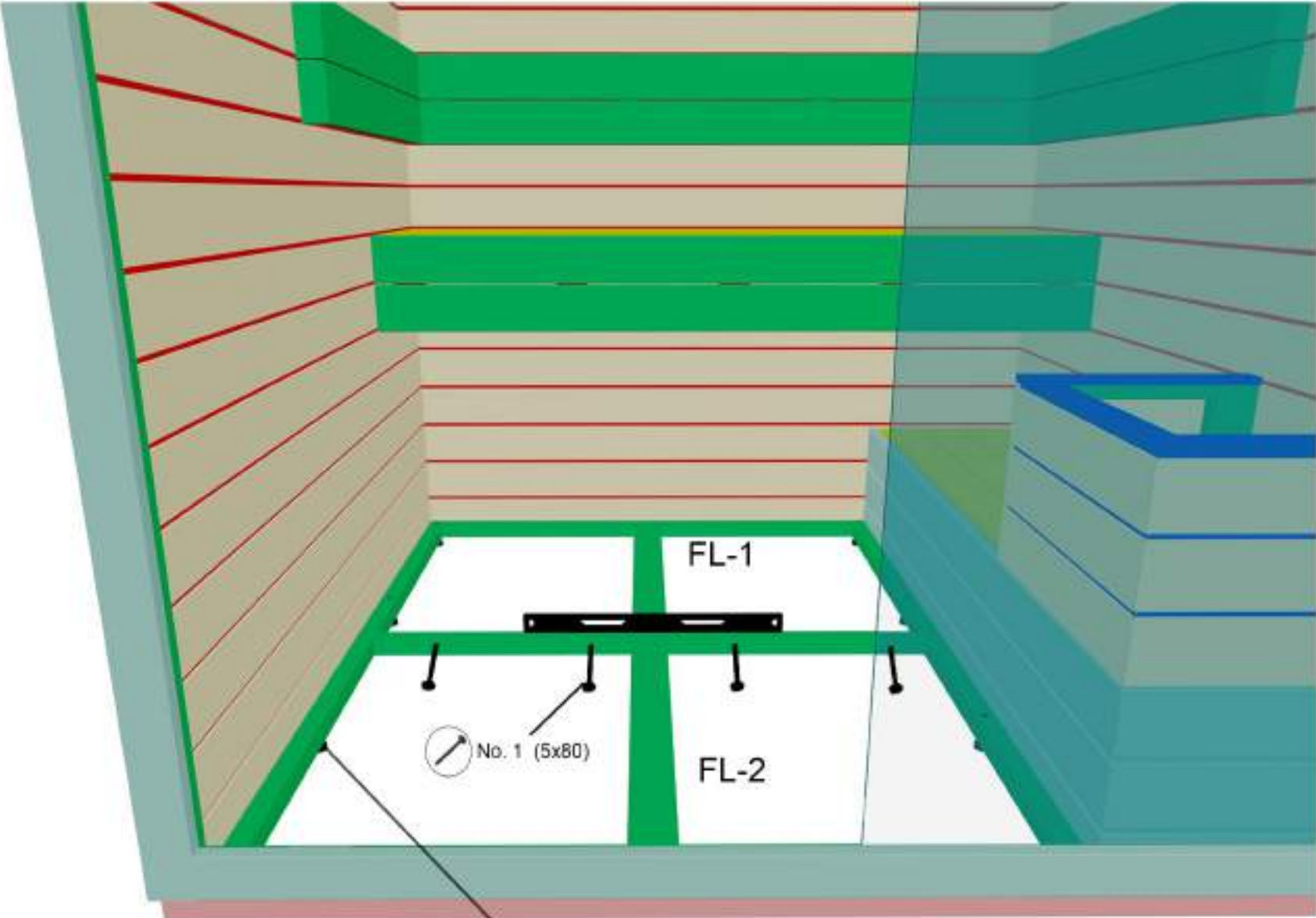

20.1 Floor grids

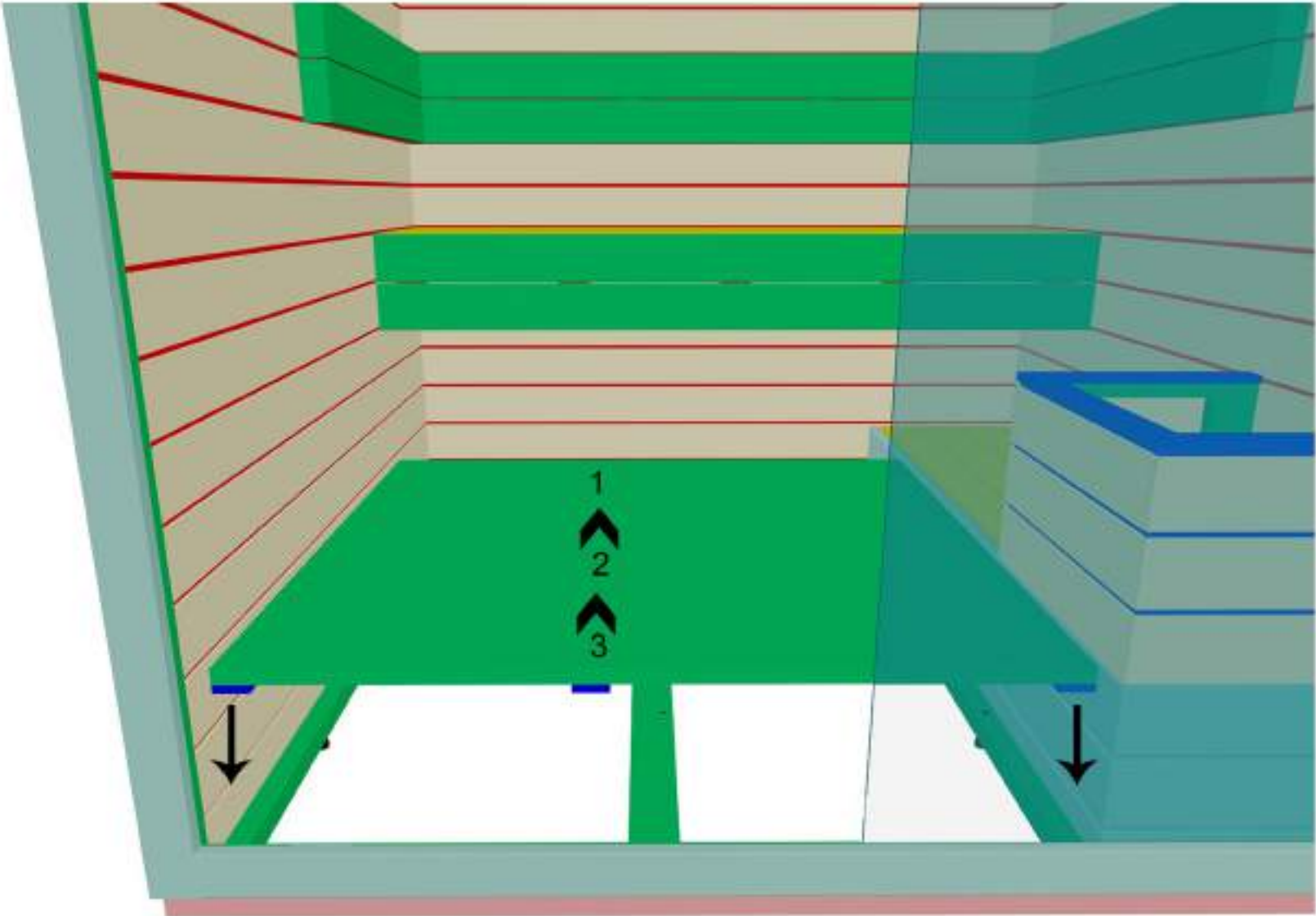

21. Wiring on ceilings

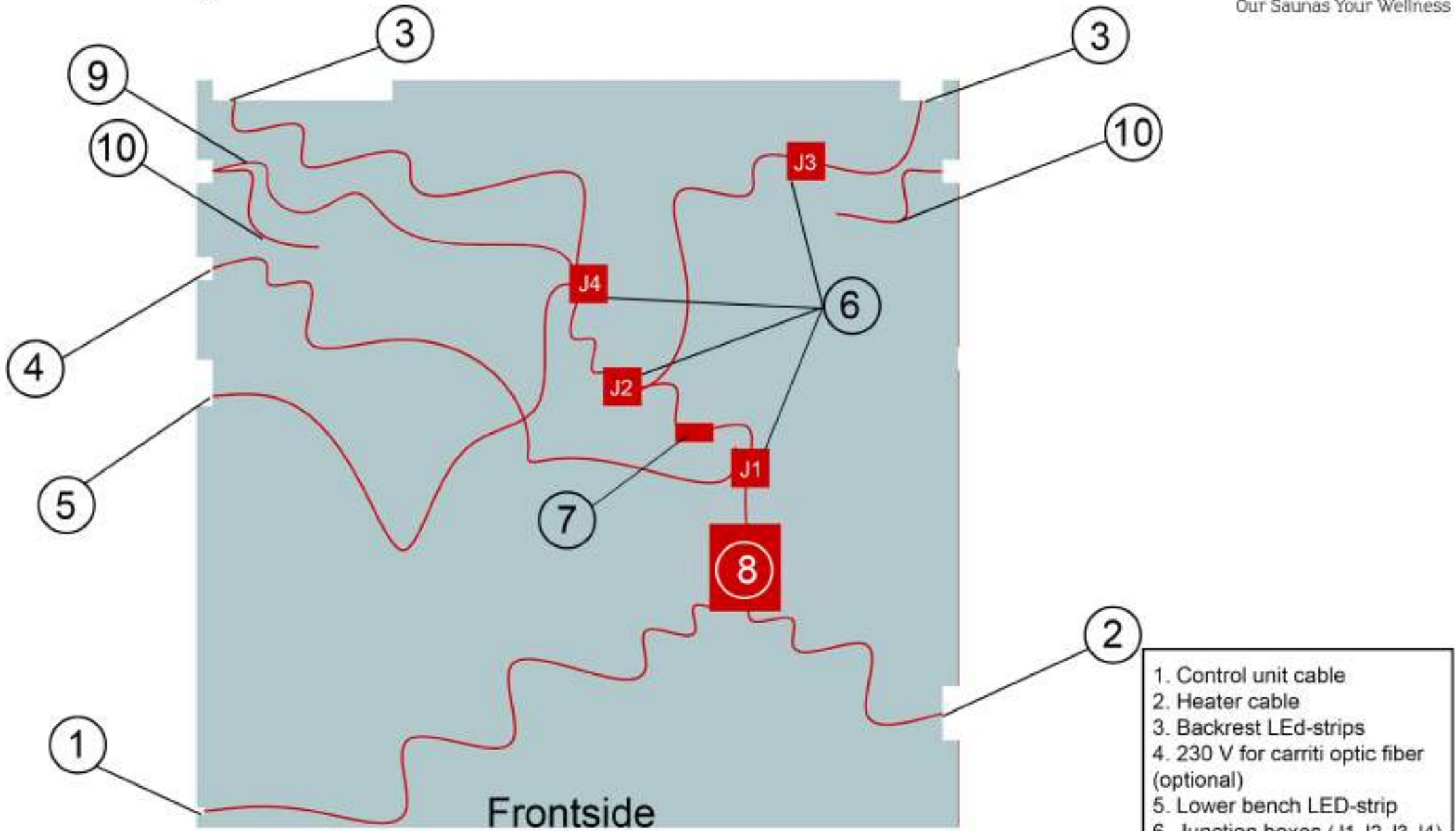

1. Control unit cable
2. Heater cable
3. Backrest LED-strips
4. 230 V for carriti optic fiber (optional)
5. Lower bench LED-strip
6. Junction boxes (J1,J2,J3,J4)
7. Transformer
8. Power unit
9. Lamp cable (optional)
10. Speakers (optional)

! Always use certified electrician